



18+

910029

Mountain Fortress

Designed by SleeplessNight





910029 Mountain Fortress

Designed by
SleeplessNight

Thanks to all LEGO® fans for your faith and support! Congrats to all BDP designers who made it a tough contest, acknowledgments to the Bricklink Team for the opportunity and special thanks to Rebekah for her role in making this set production-ready.



Bergfestung

Vielen Dank allen LEGO® Fans für die treue Unterstützung! Ich möchte allen BDP-Designern gratulieren, die den harten Wettbewerb überstanden haben, und mich beim BrickLink-Team für diese Gelegenheit bedanken. Mein besonderer Dank gilt Rebekah, die großen Anteil daran hatte, dieses Set produktionsfertig zu machen.

Entworfen von SleeplessNight

Forteresse de montagne

Merci à tous les fans de LEGO® pour leur confiance et leur soutien ! Félicitations à tous les concepteurs du BDP qui ont participé à ce concours ardu et remerciements à l'équipe Bricklink pour l'opportunité qu'elle m'a donnée. Un grand merci également à Rebekah sans qui ce set n'aurait pu prendre vie.

Conçue par SleeplessNight

Fortezza di montagna

Ringrazio tutti i fan LEGO® per la loro fiducia e il supporto! Congratulazioni a tutti i designer BDP che hanno reso questa competizione davvero... competitiva! Tanti ringraziamenti vanno al team Bricklink per l'opportunità, e un ringraziamento speciale a Rebekah che ha preparato questo set per la produzione.

Ideato da SleeplessNight

Fortaleza en la Montaña

¡Gracias a todos los fans de LEGO® por creer en mí y apoyarme! Enhorabuena a todos los diseñadores del BDP que hicieron de este un concurso difícil, mi reconocimiento al equipo de BrickLink por la oportunidad, y un agradecimiento especial a Rebekah por esforzarse en preparar el set para su producción.

Diseñado por SleeplessNight

Fortaleza na Montanha

Obrigado a todos os nossos fãs da LEGO® pela sua confiança e apoio! Parabéns a todos os designers BDP que tornaram este desafio ainda mais exigente, um agradecimento à Equipa Bricklink pela oportunidade e em especial à Rebekah pelo seu papel na criação deste set preparado para a produção.

Criado por SleeplessNight

山地要塞

感谢所有乐高®粉丝的信任和支持! 祝贺所有使比赛成为一场龙争虎斗的 BDP 设计师, 感谢 Bricklink 团队给我这次机会, 并特别感谢 Rebekah 在为这款产品做好生产准备方面所付出的努力。

由 SleeplessNight 设计

Górska twierdza

Dziękuję wszystkim fanom LEGO® za wiarę i wsparcie! Gratuluję wszystkim projektantom biorącym udział w BDP, którzy postavili poprzeczkę naprawdę wysoko. Dziękuję zespołowi Bricklink za tę szansę i przesyłam specjalne wyrazy uznania dla Rebeki za jej wysiłki związane z przygotowaniem tego zestawu do produkcji.

Autor: SleeplessNight



bricklink
designer
program

SERIES 1



910029 Mountain Fortress

Designed by
SleeplessNight

Thanks to all LEGO® fans for your faith and support! Congrats to all BDP designers who made it a tough contest, acknowledgments to the Bricklink Team for the opportunity and special thanks to Rebekah for her role in making this set production-ready.



Horská pevnost

Děkujeme všem fanouškům LEGO® za věrnost a podporu! Gratulujeme všem designérům BDP za účast v náročném soutěži, děkujeme týmu Bricklink za příležitost a zvláštní poděkování Rebekce za její podíl při přípravě této sady do výroby.

Autor návrhu: SleeplessNight

Horská pevnost'

Ďakujem všetkým fanúšikom LEGO® za dôveru a podporu! Gratulujem všetkým dizajnérom z tohto programu, vďaka ktorým bola súťaž napínavá. Vážim si túto príležitosť od tímu Bricklink a špeciálne poďakovanie patrí Rebekah za jej pomoc, keď sme stavebnicu chystali do výroby.

Navrhovateľ: SleeplessNight

Hegyi erőd

Köszönjük minden LEGO® rajongónak, hogy hitt bennünk és támogattott minket! Gratulálunk minden BDP-tervezőnek, aki részt vett ezen a kemény versenyen! Köszönet a Bricklink csapatnak a lehetőségért, és külön köszönet Rebekah-nak a közreműködéséért, hogy előkészítette gyártásra a készletet!

Tervezte: SleeplessNight

Fortăreața montană

Mulțumesc tuturor fanilor LEGO® pentru încredere și susținere! Felicitări tuturor designerilor BDP care au făcut ca acest concurs să fie greu, mulțumiri echipei BrickLink pentru ocazie și mulțumiri speciale lui Rebekah pentru rolul ei în pregătirea acestei set pentru producție.

Concept de: SleeplessNight

Kalnu cietoksnis

Pateicamies visiem LEGO® faniem par uzticibu un atbalstu! Apsveicam visus BDP dizainerus, kuri piedalījās konkursā, vēlamies izteikt pateicību Bricklink komandai par šo iespēju un jo īpaši pateicamies Rebekai par viņas darbu, sagatavojot šo komplektu ražošanai.

Autors: SleeplessNight

Mäekindlus

Tänname kõiki LEGO® fänne usu ja toetuse eest! Õnnitlused kõigile BDP disaineritele, kes muutsid võistluse raskeks, tunnustused Bricklinki meeskonnale võimaluse eest, ja eriline tänu Rebekahle tema rolli eest selle komplekti tootmiseks ettevalmistamisel.

Kujundanud: SleeplessNight

Tvrtové kalnuose

Děkujeme visiems LEGO® gerbėjams už tikėjimą ir palaikymą! Sveikiname visus BDP dizainerius, dalyvavusius konkurse, dėkojame „Bricklink“ komandai už suteiktą galimybę ir ypatingą padėką skiriama Rebekah už jos vaidmenį ruošiant šį rinkinį gamybai.

Sukūrė: SleeplessNight



bricklink
designer
program

SERIES 1

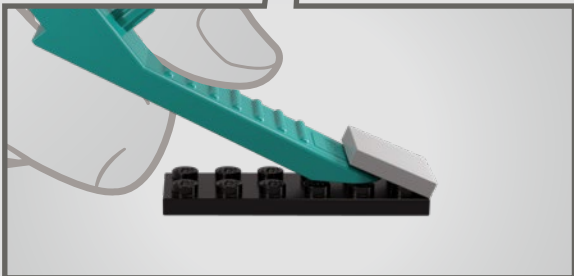
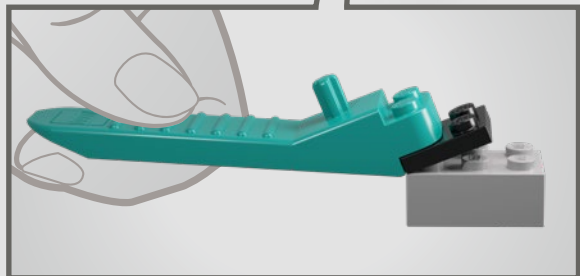
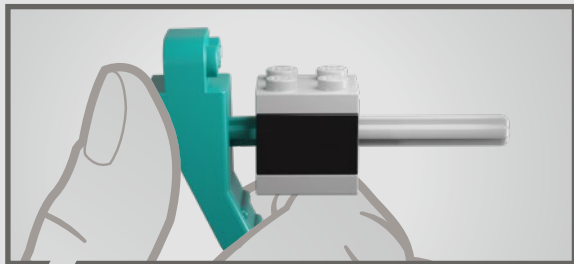
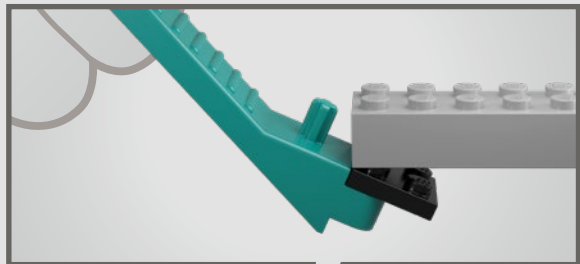



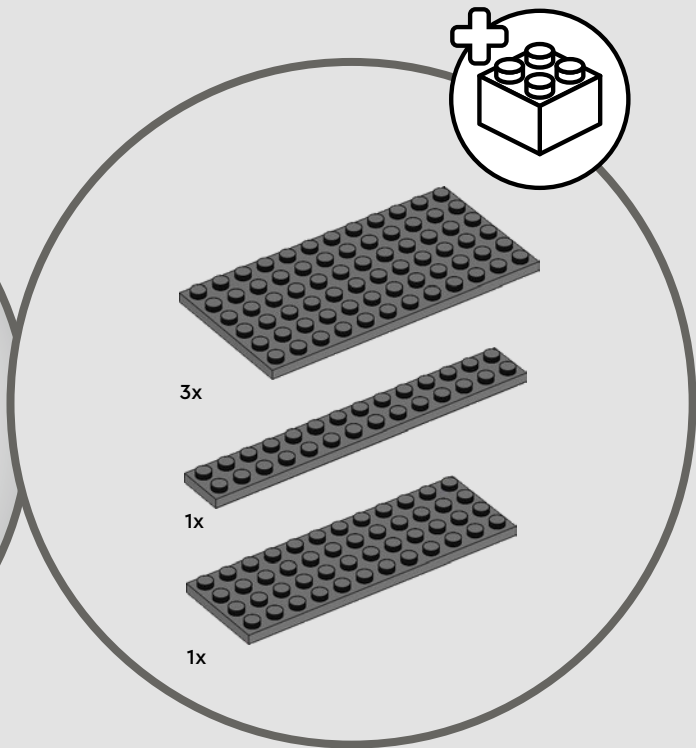

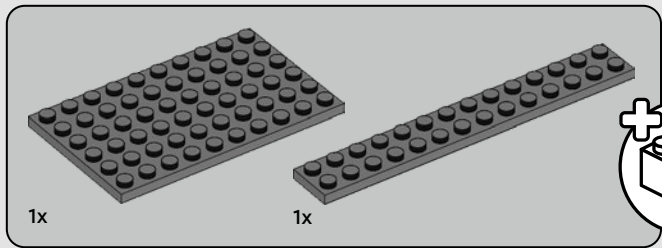

1

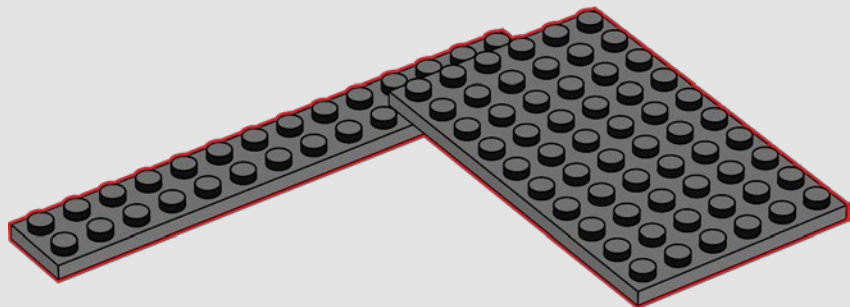

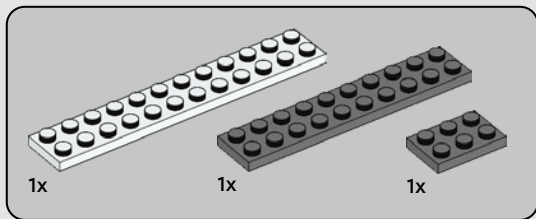

2

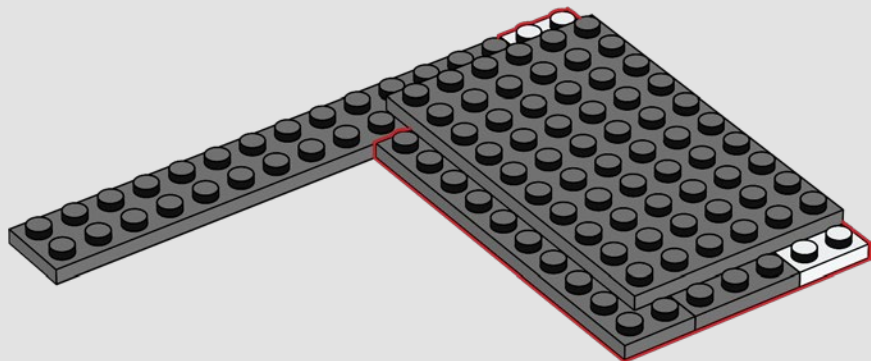

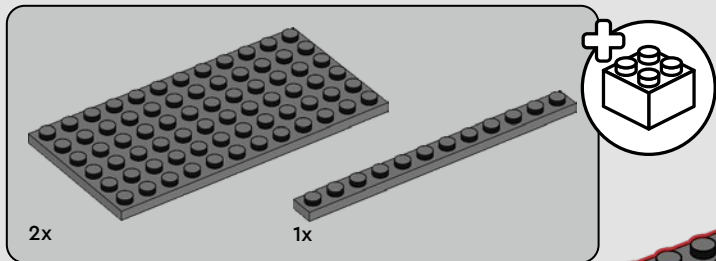

3

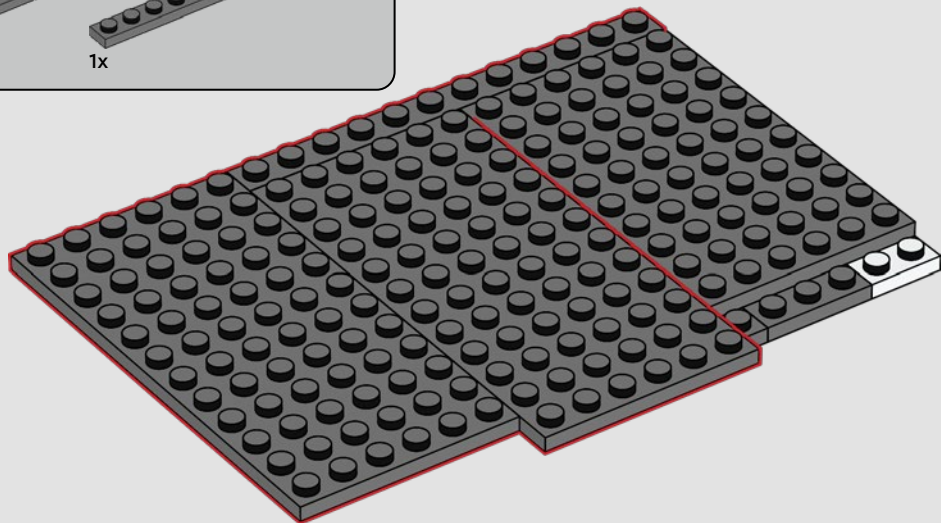

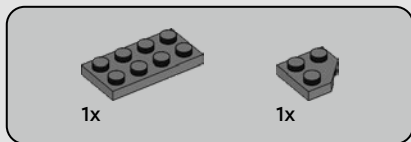

4

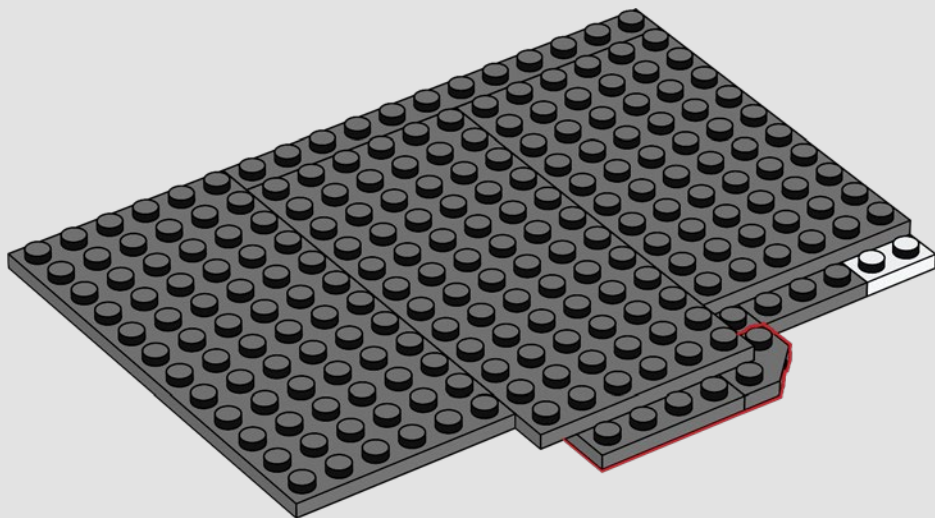

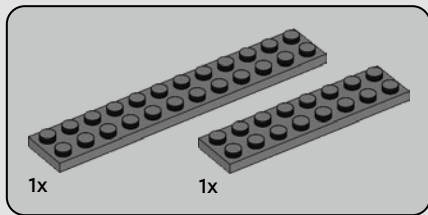

5

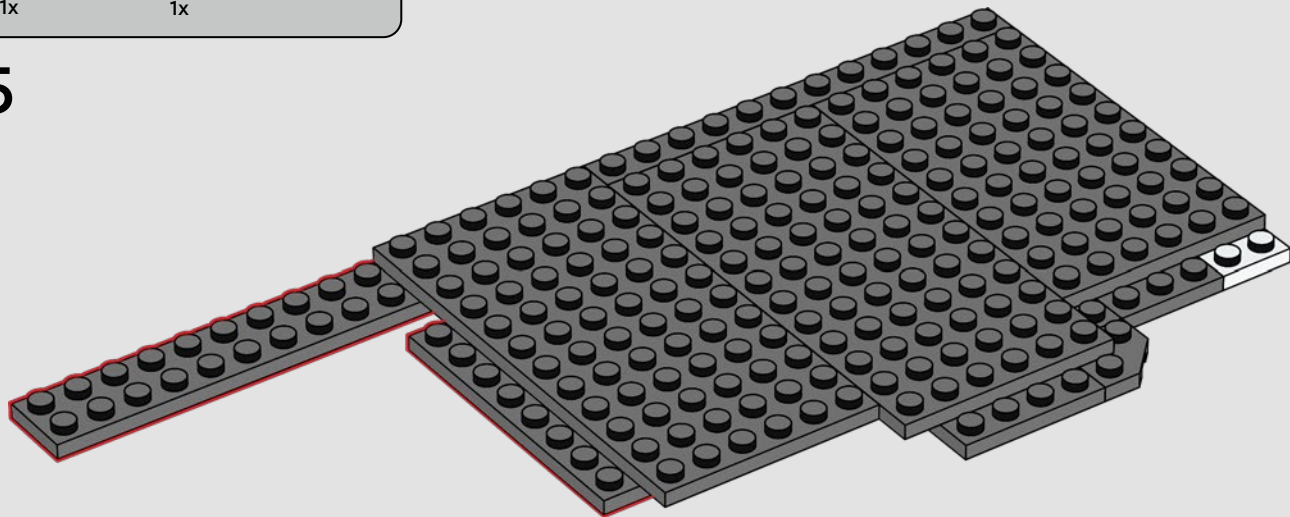

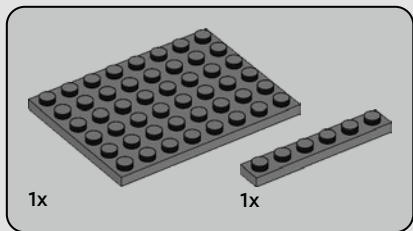

7

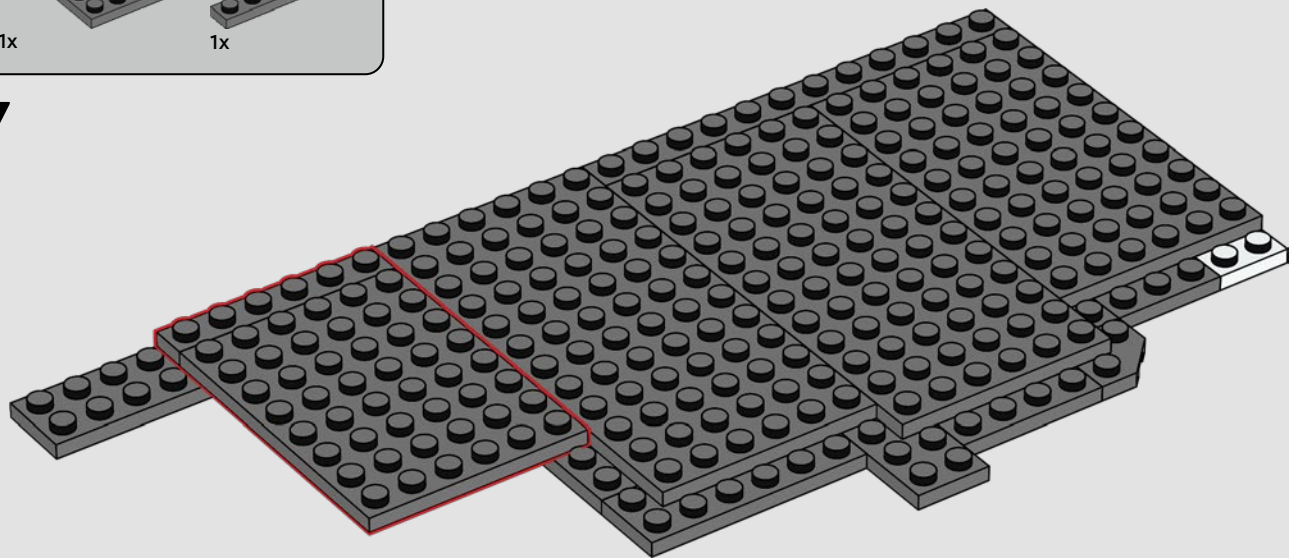

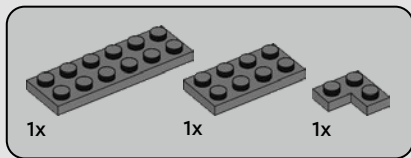

8

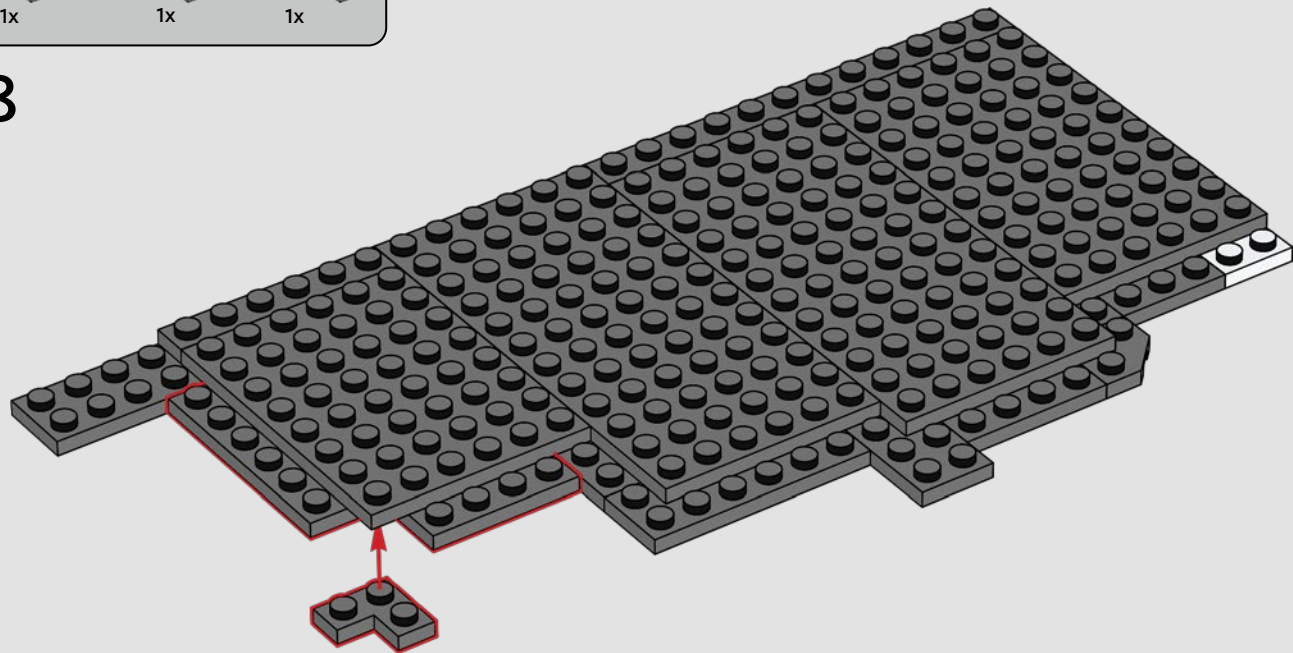

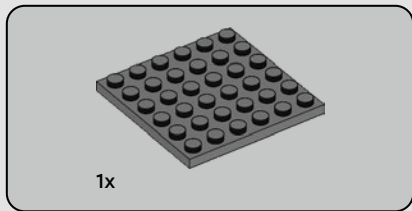

9

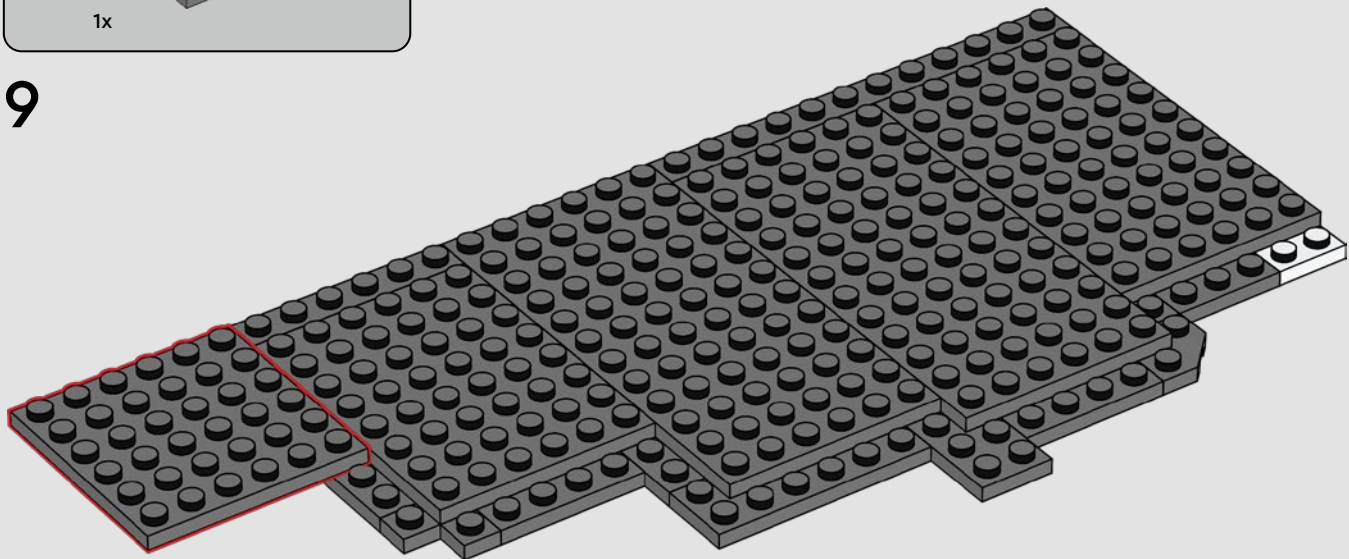

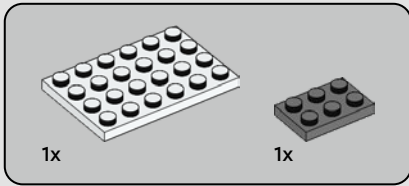

10

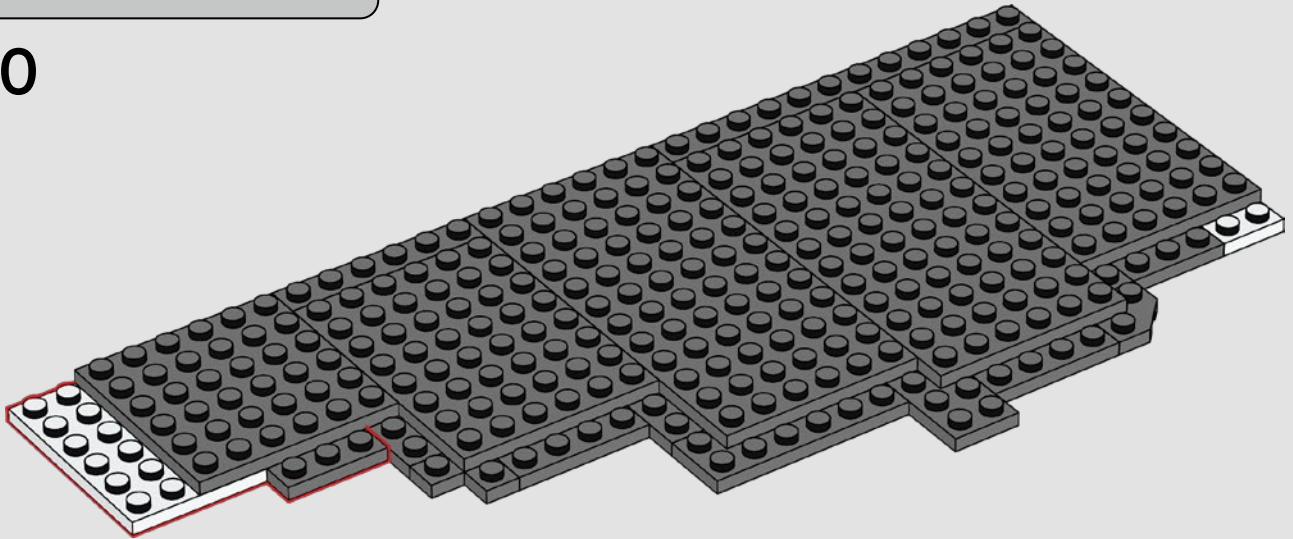

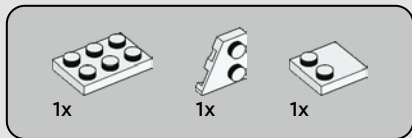

11

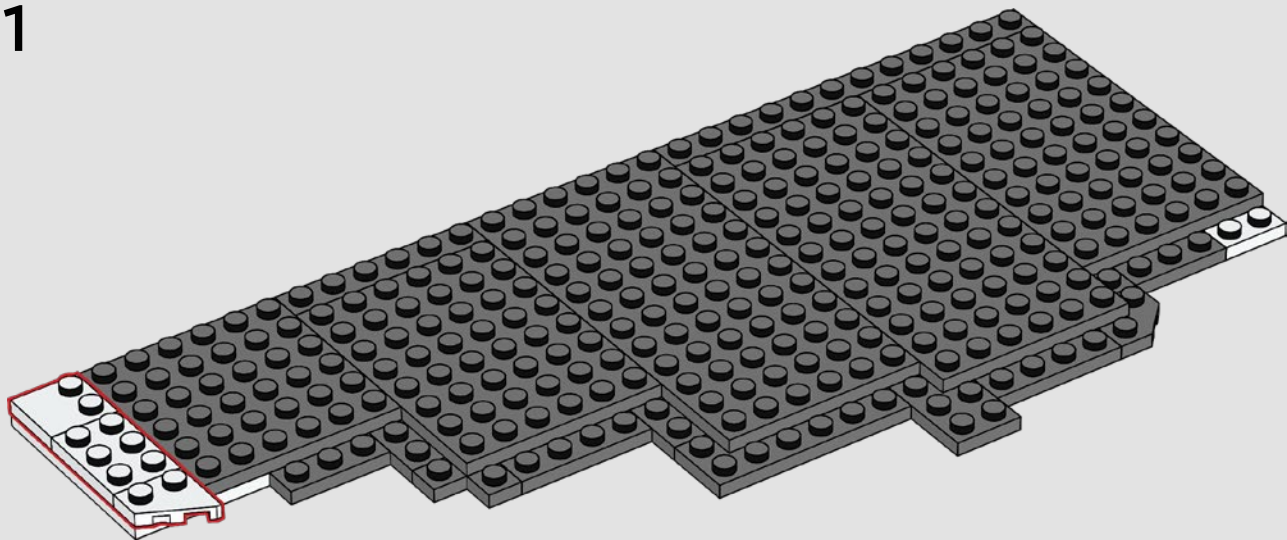

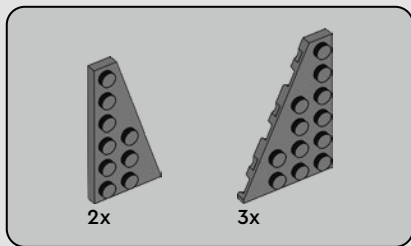

12

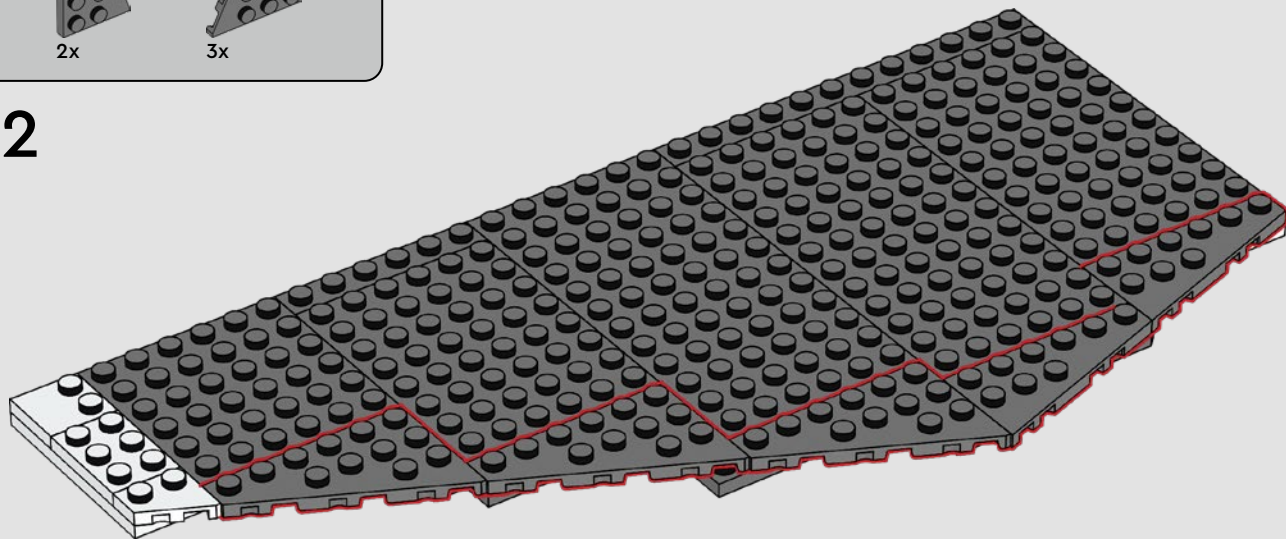



2x



13

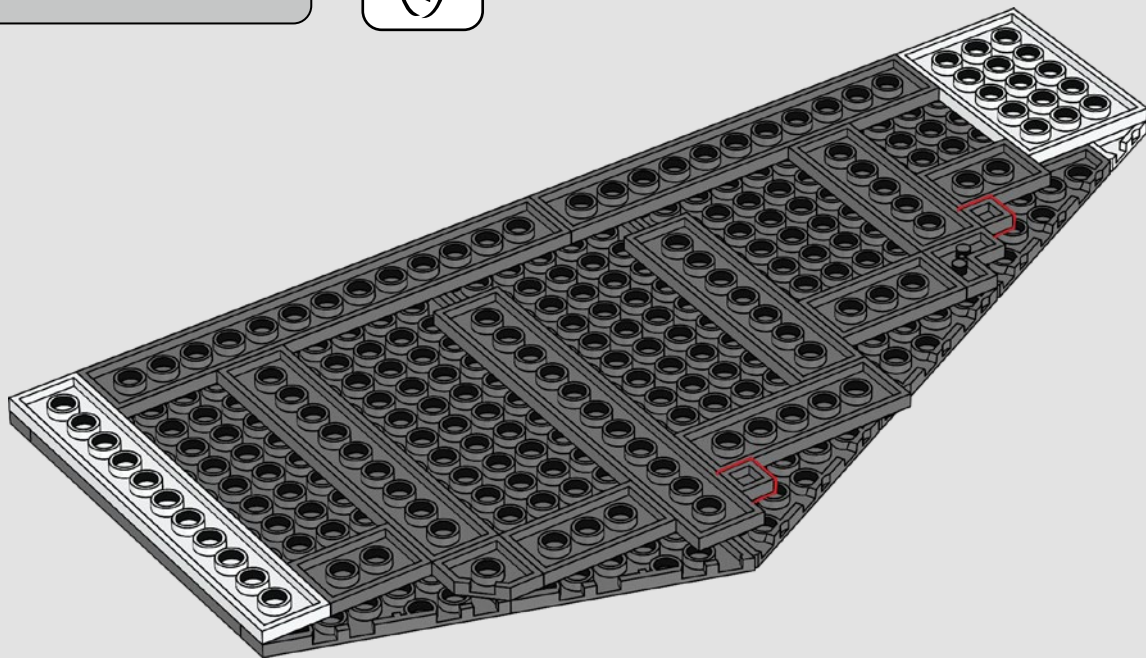

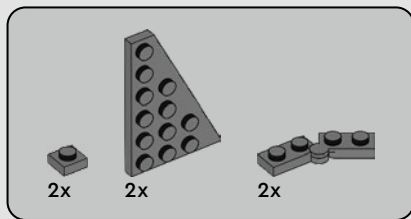

14

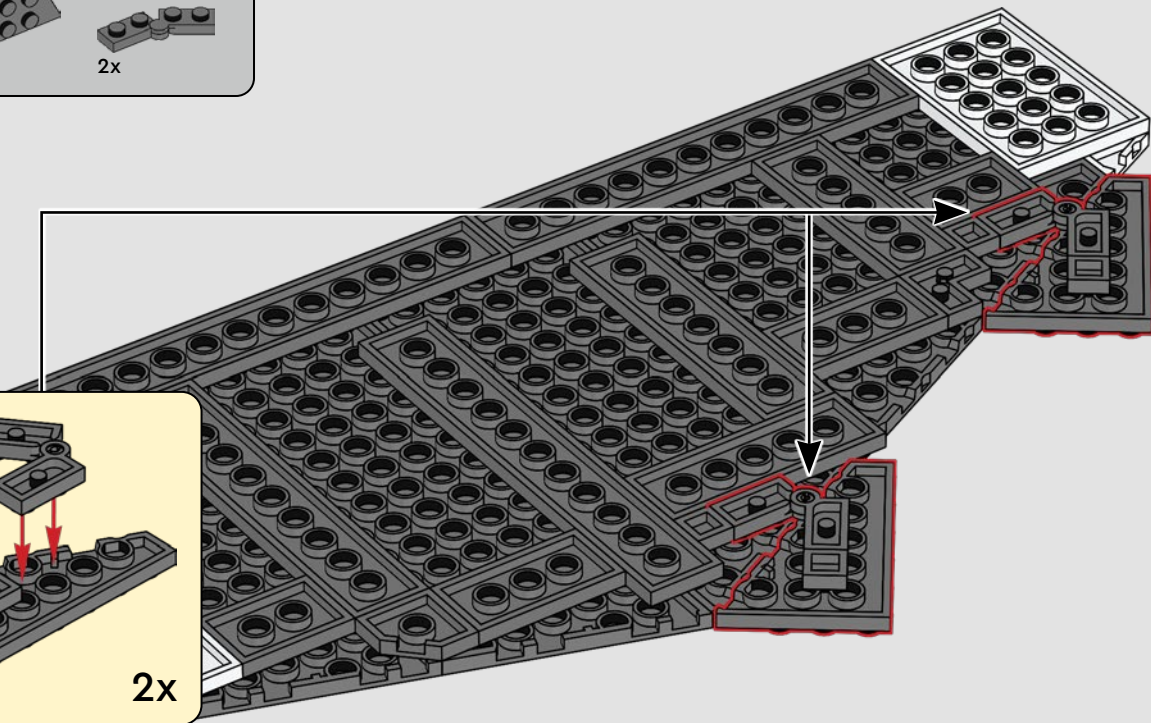
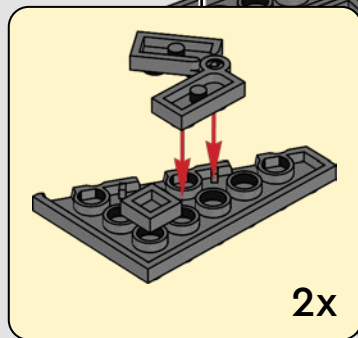

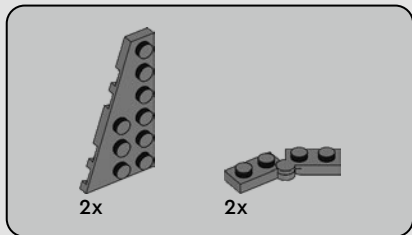

15

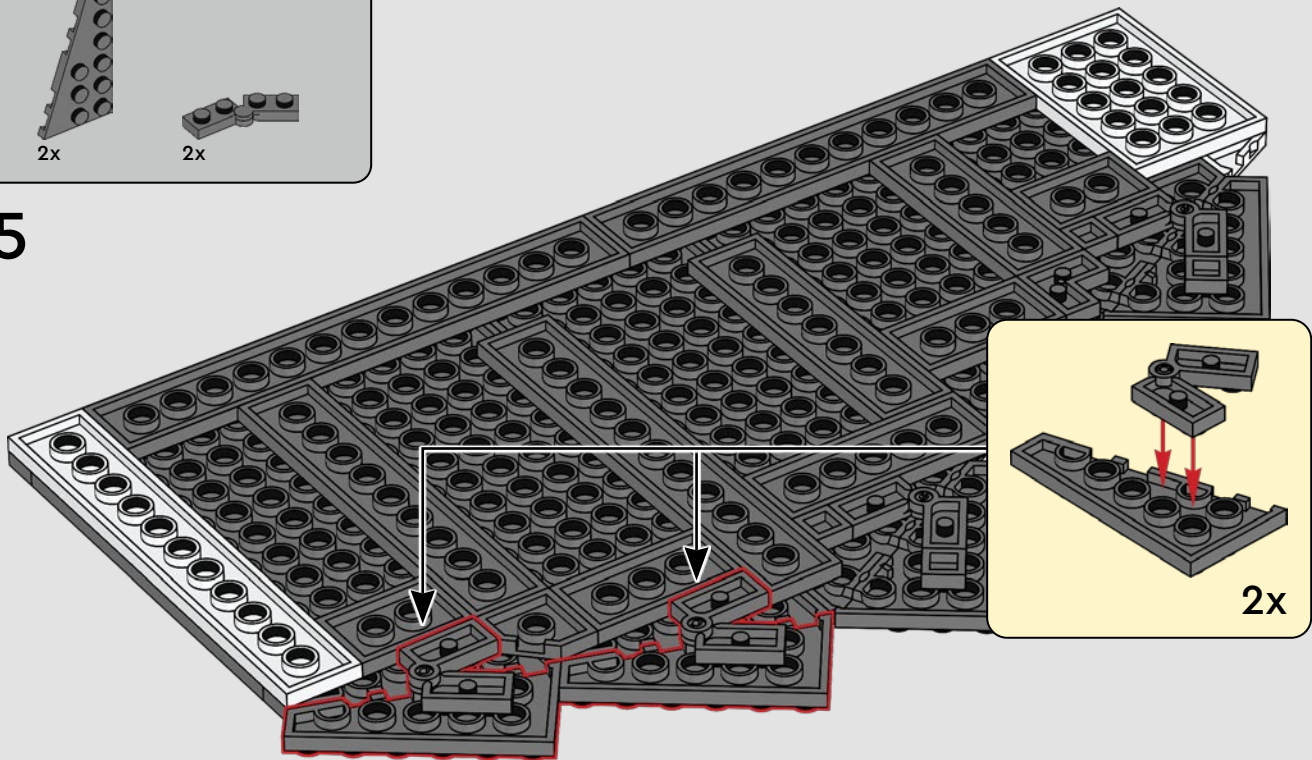

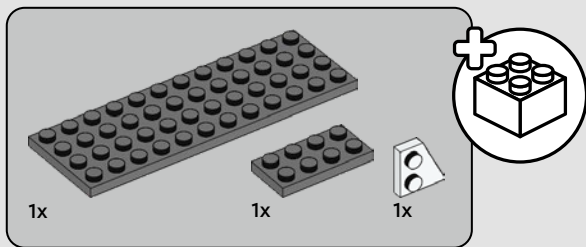

16

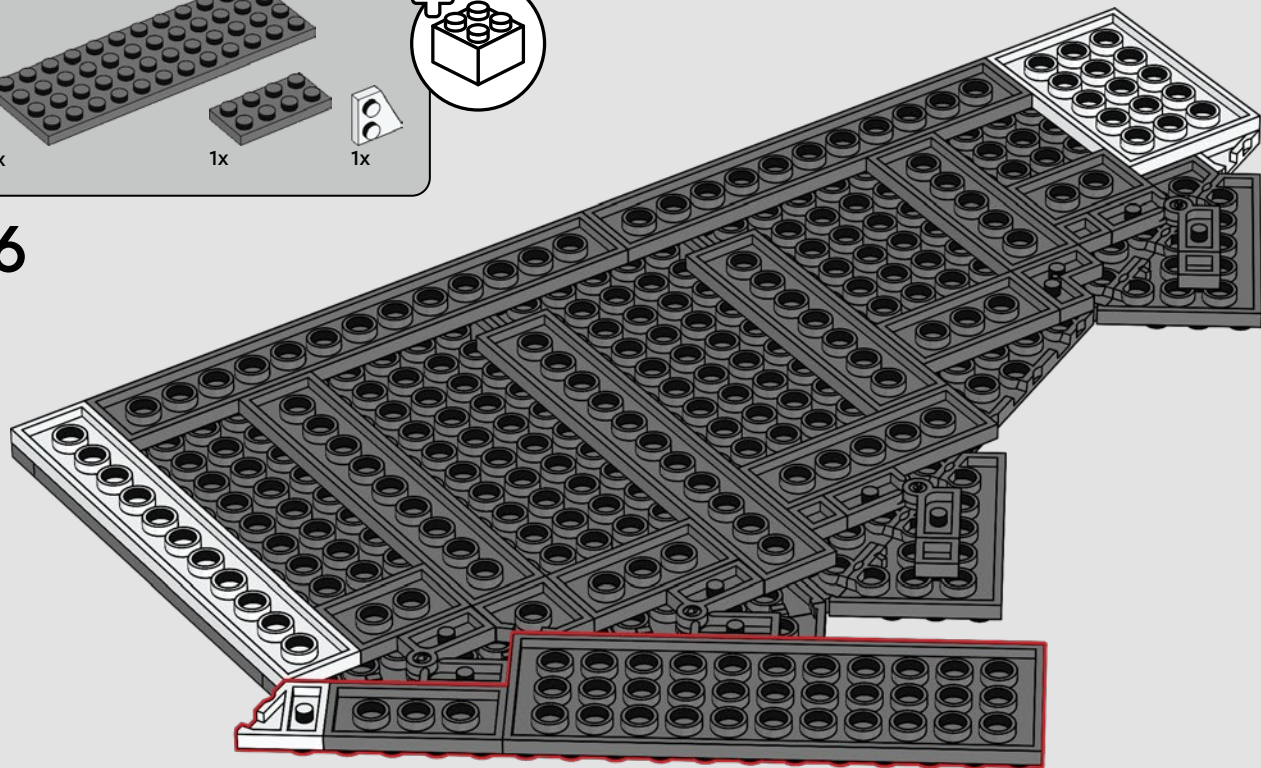

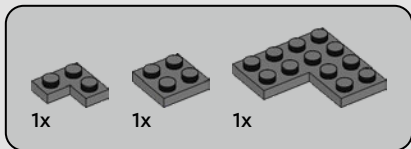

17

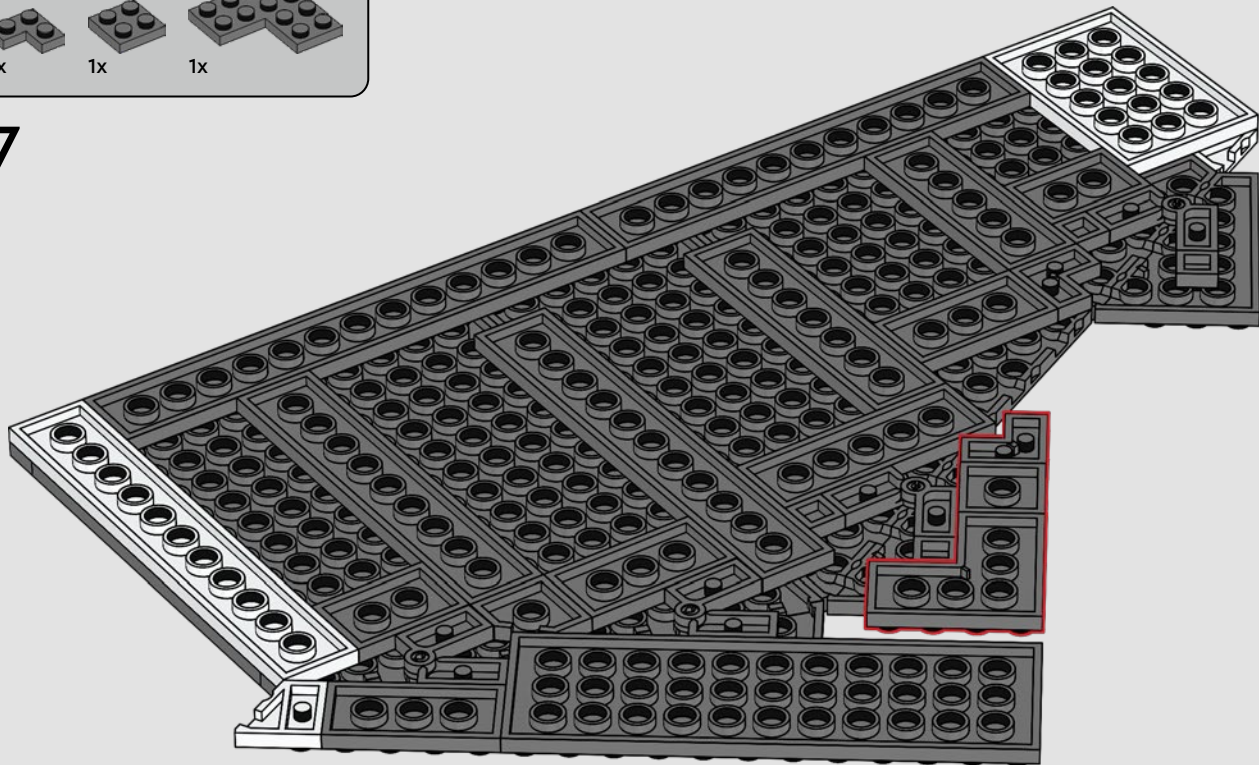

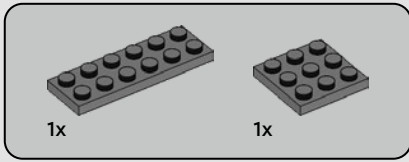

18

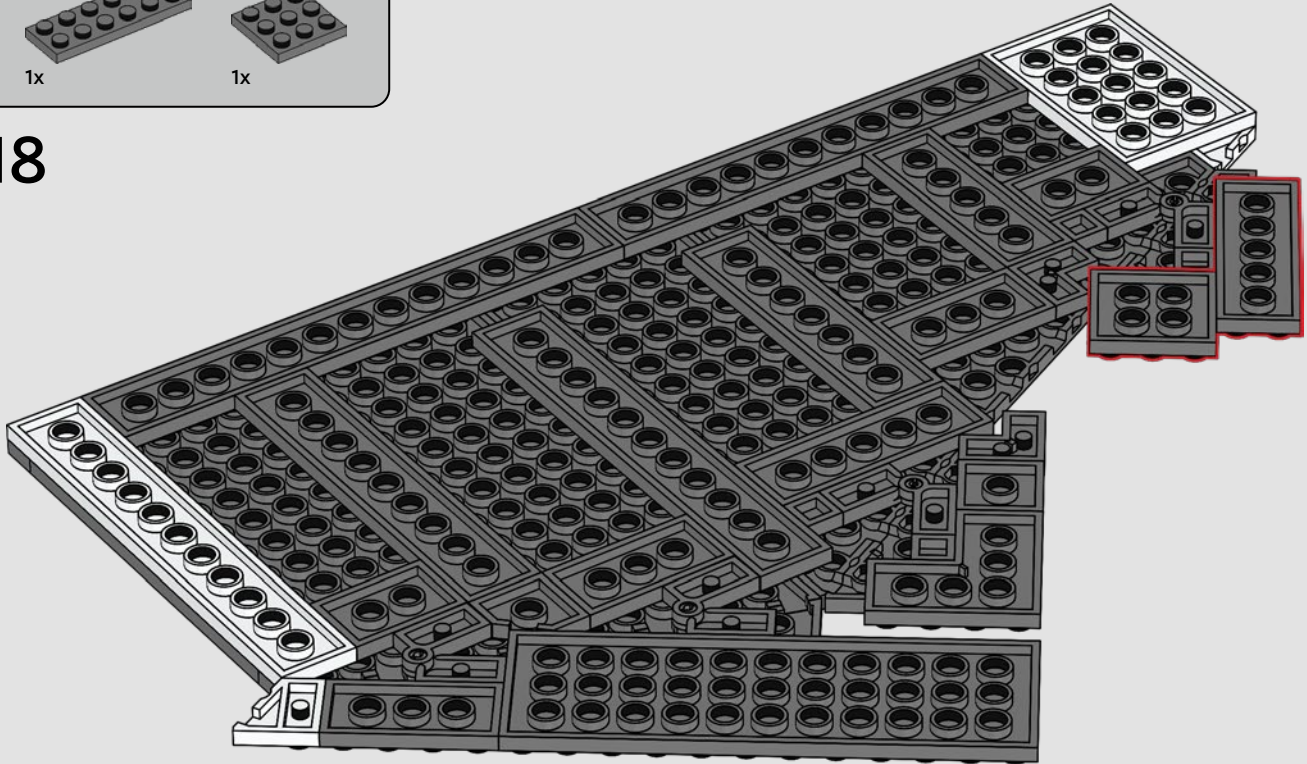

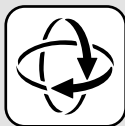
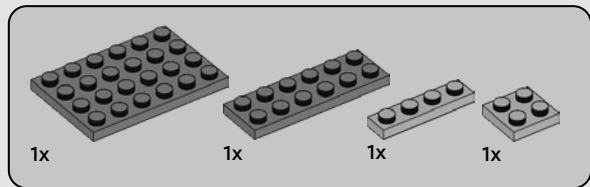

19

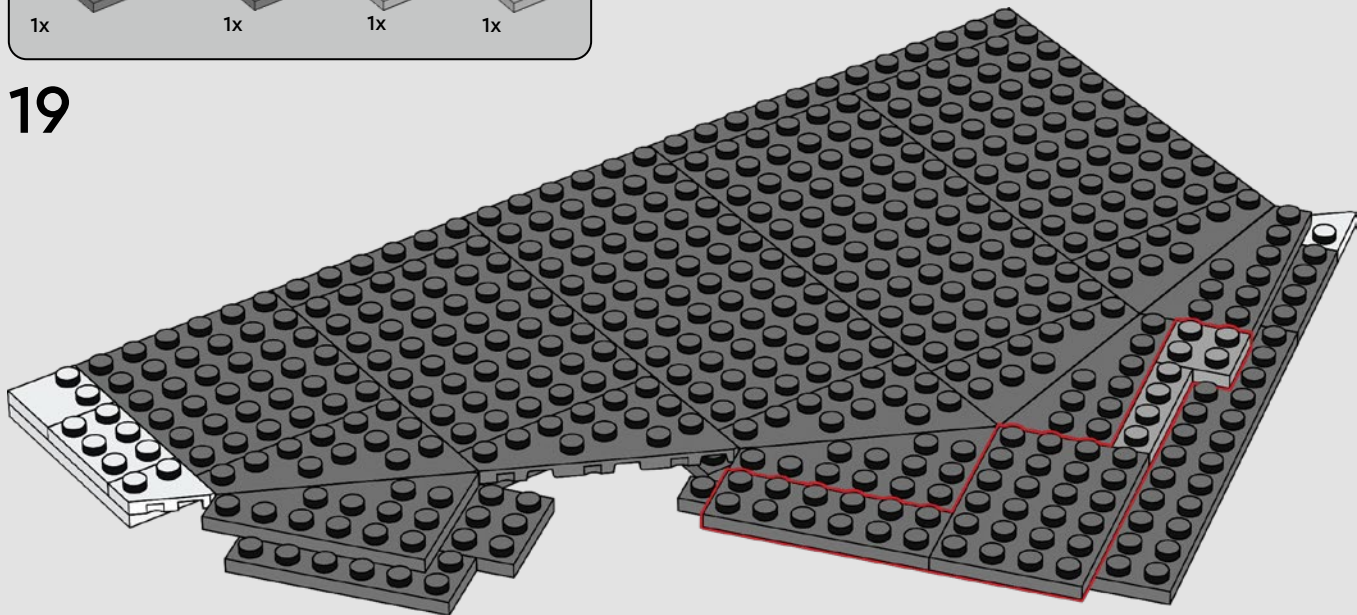

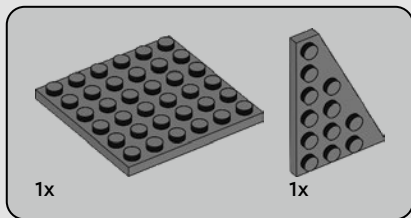

20

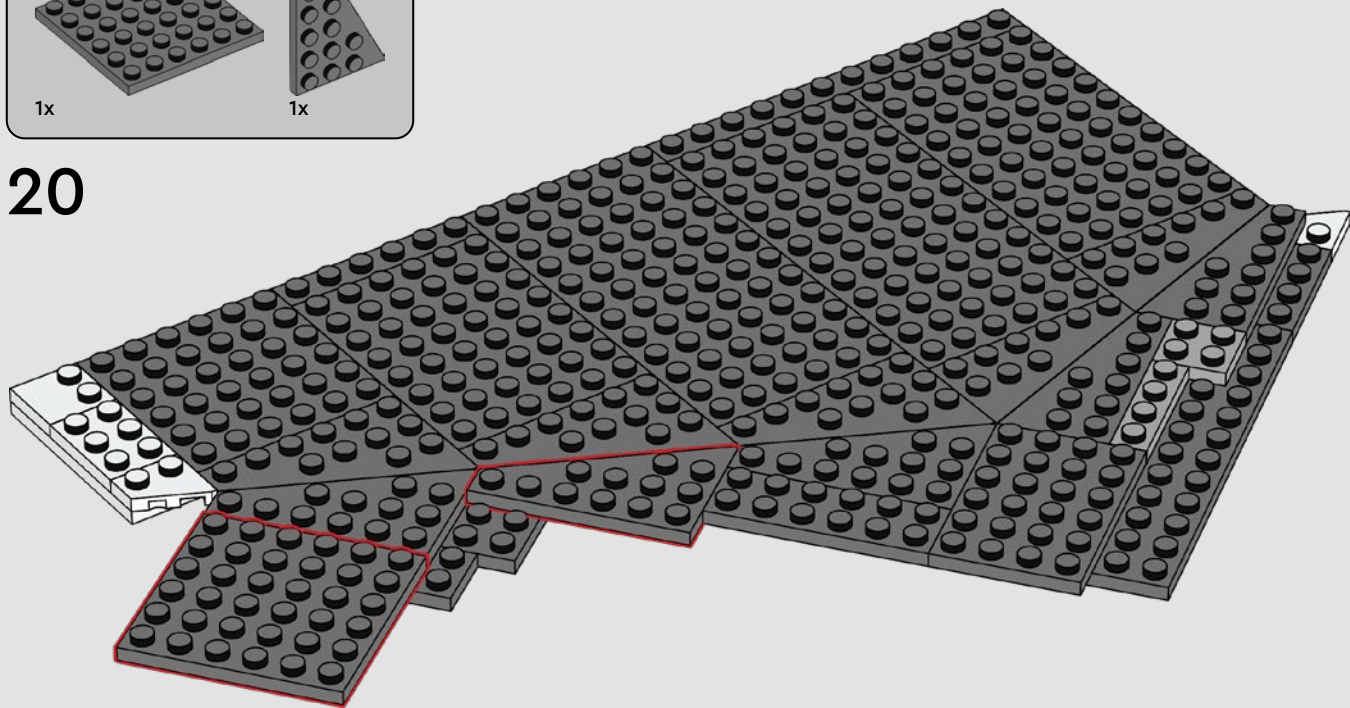

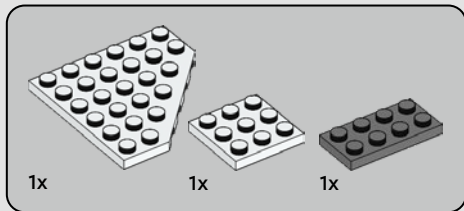

21

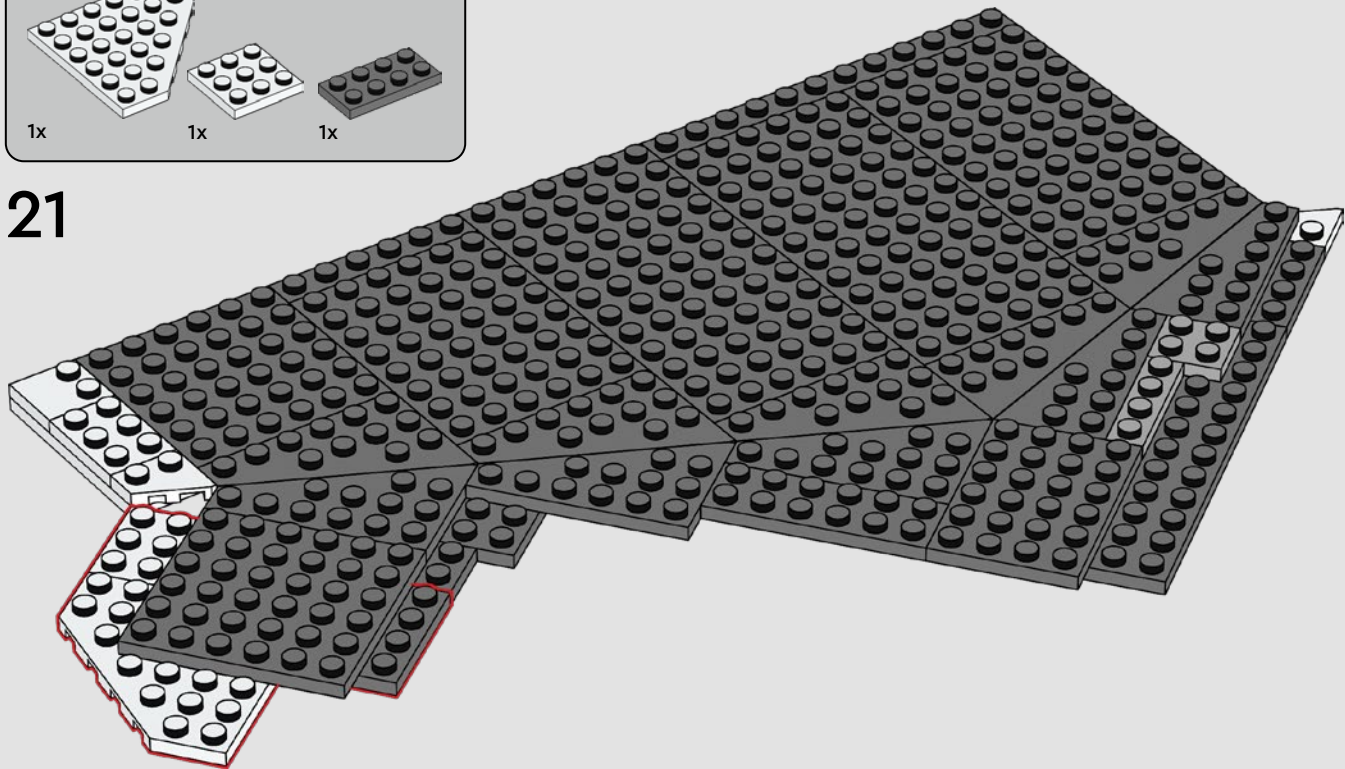

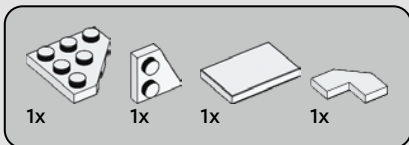

22

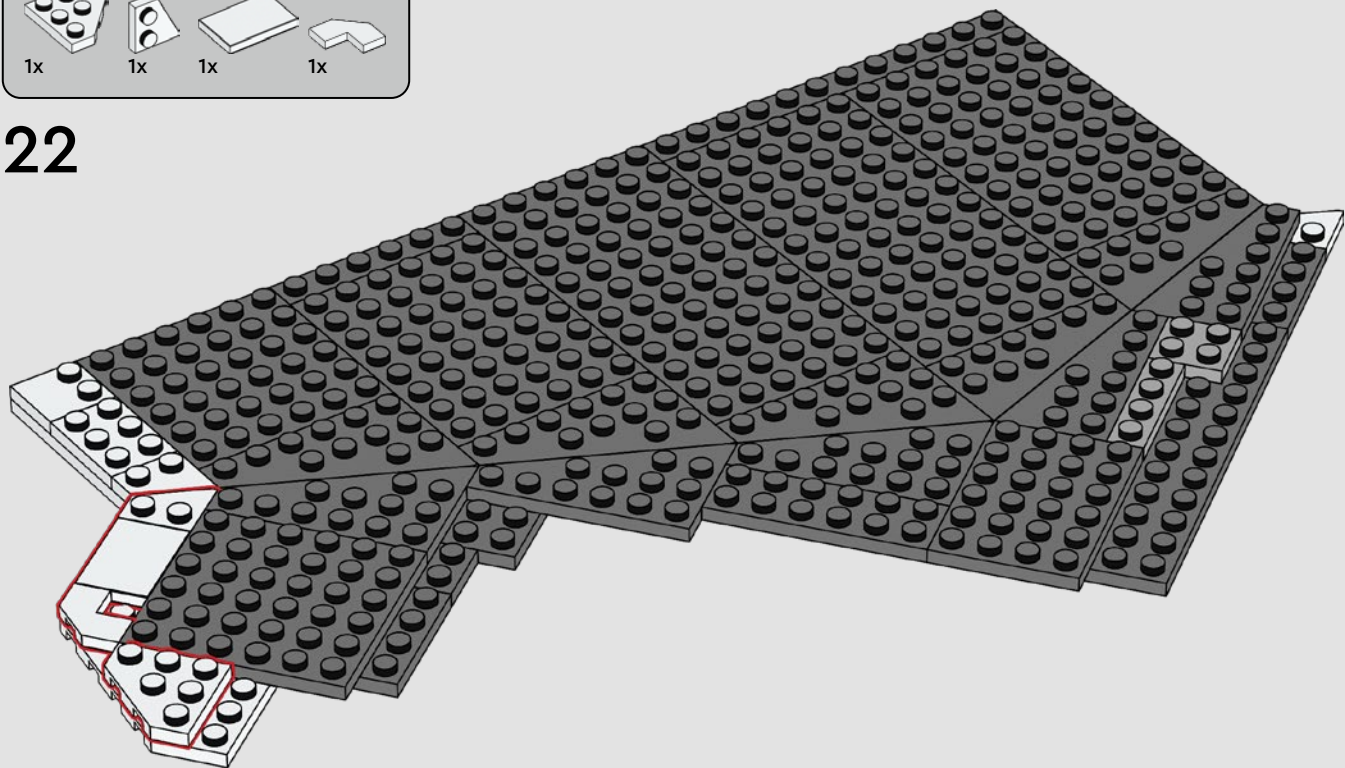

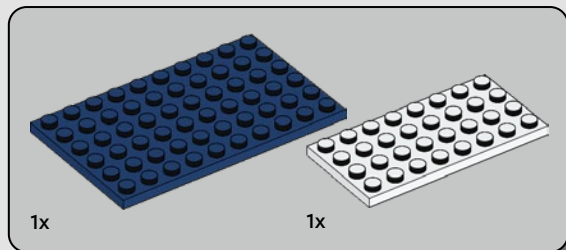

23

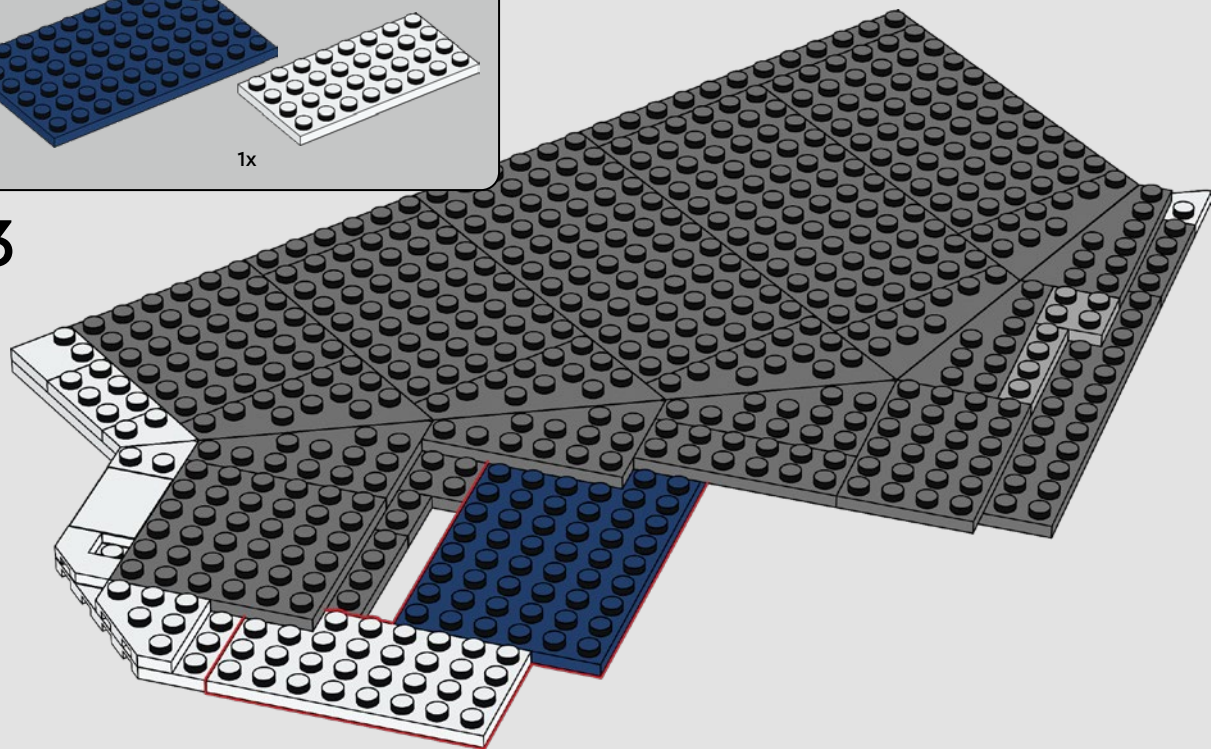

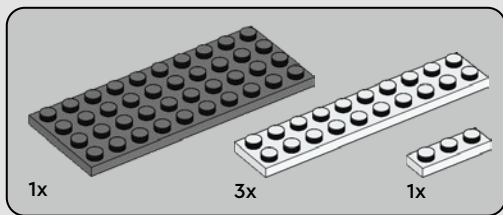

24

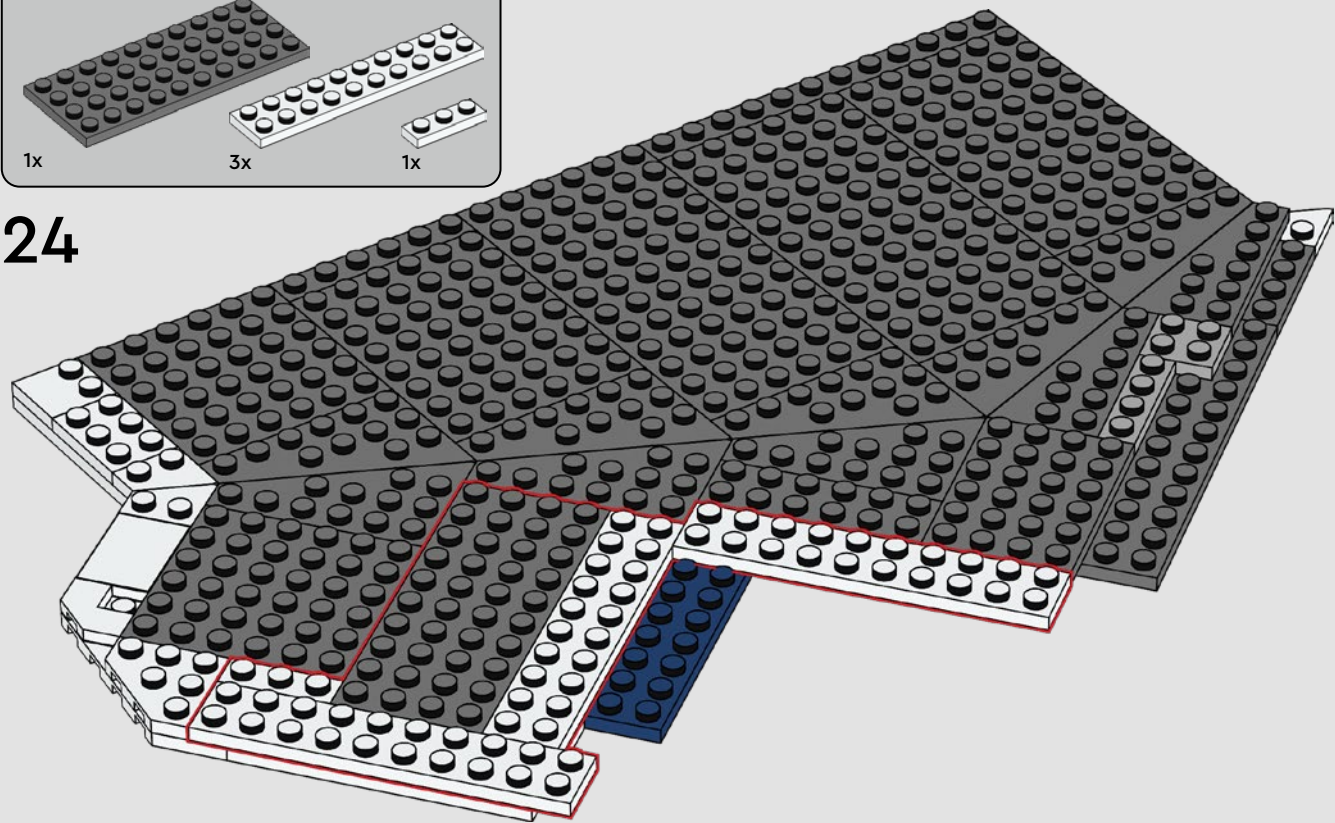

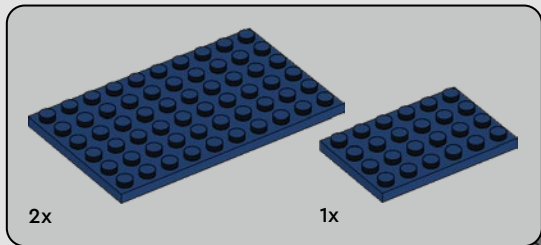

25

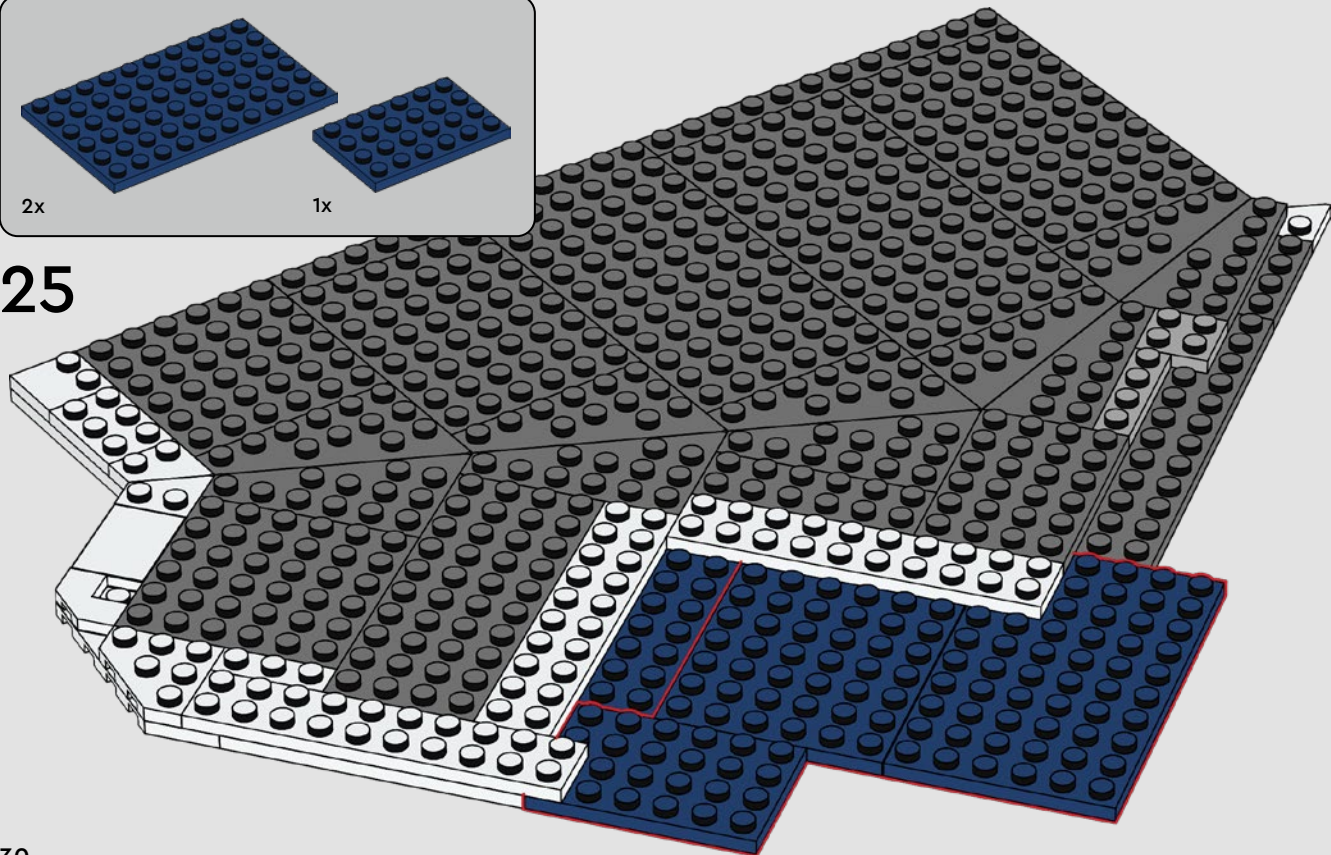

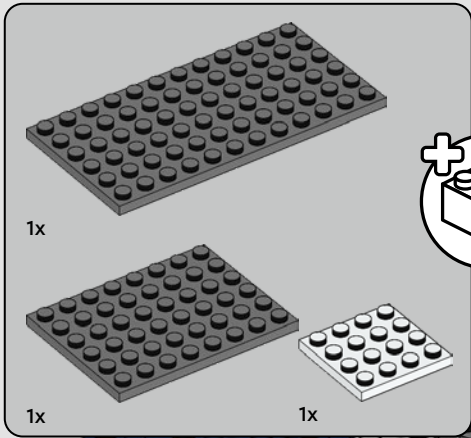

26

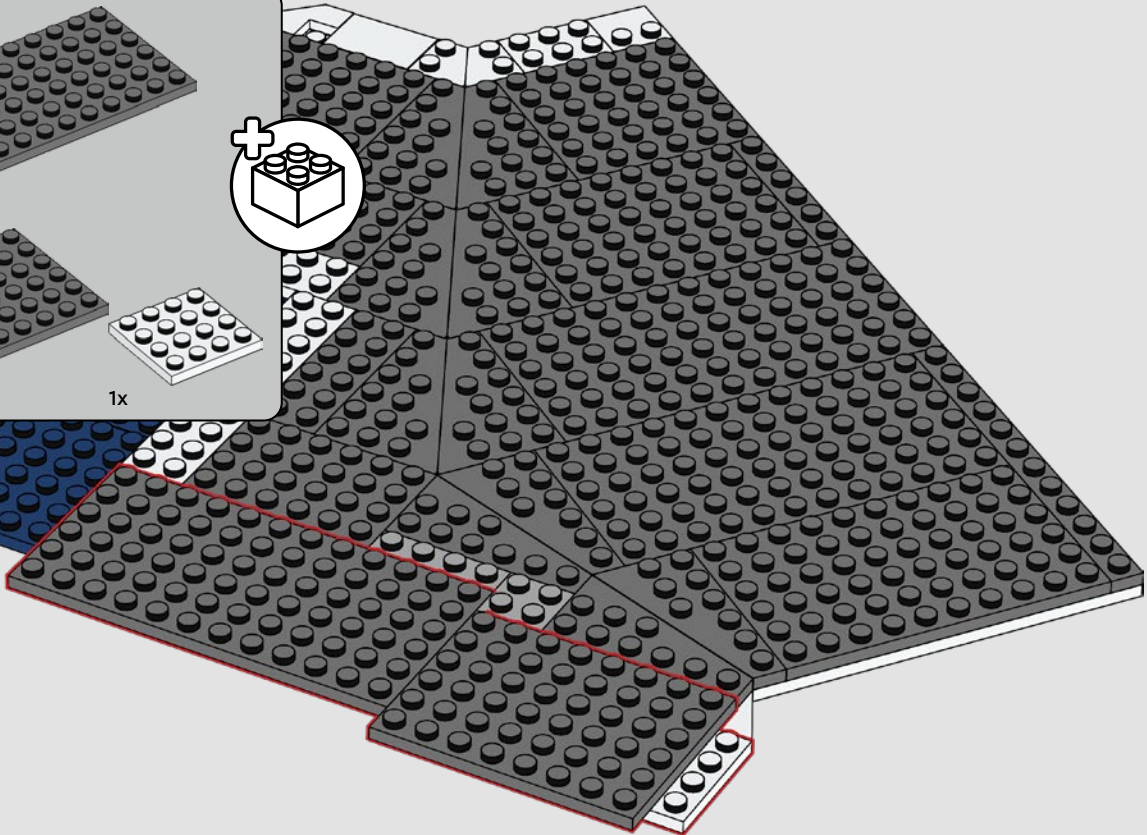

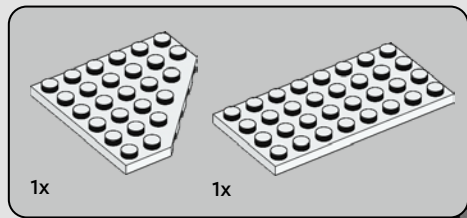

27

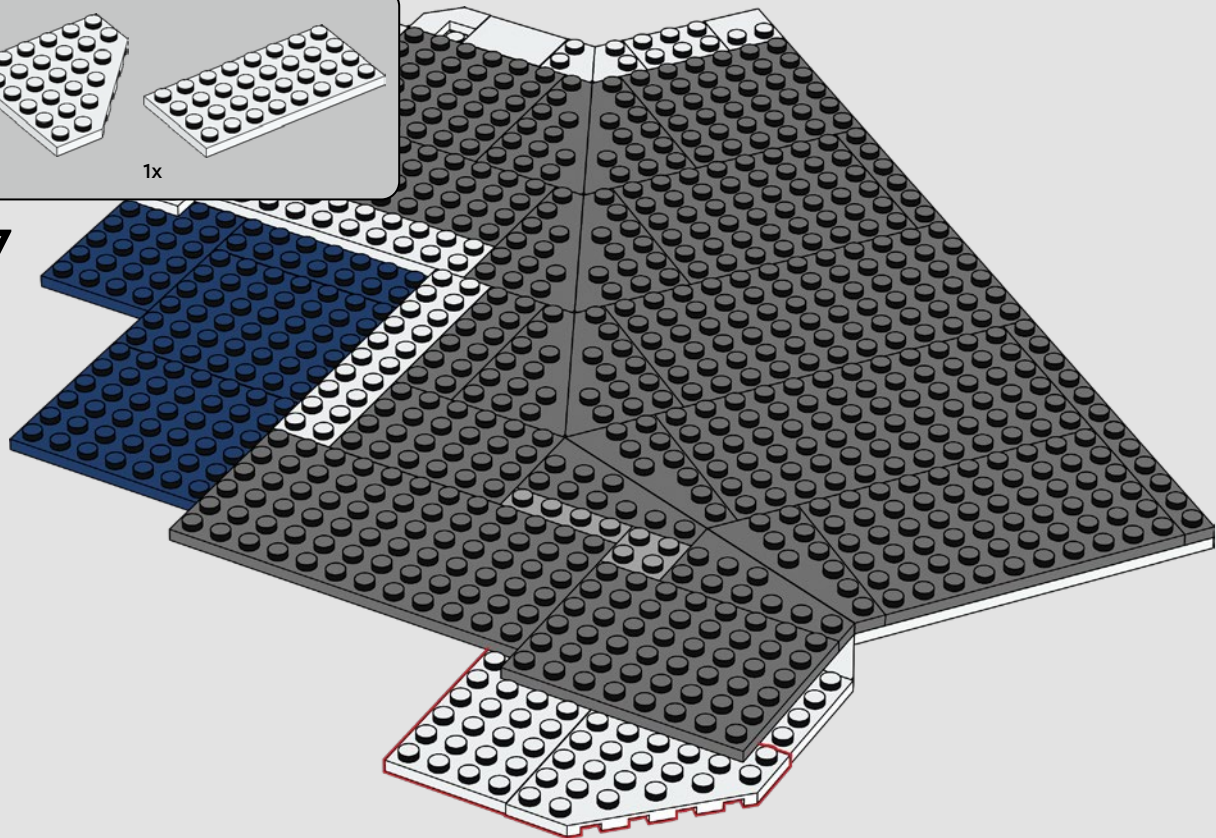

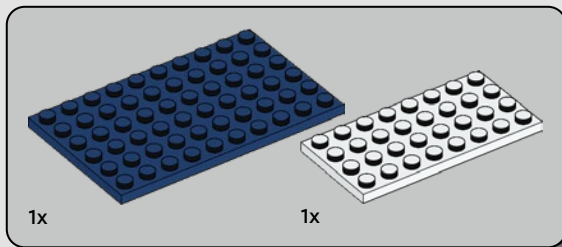

28

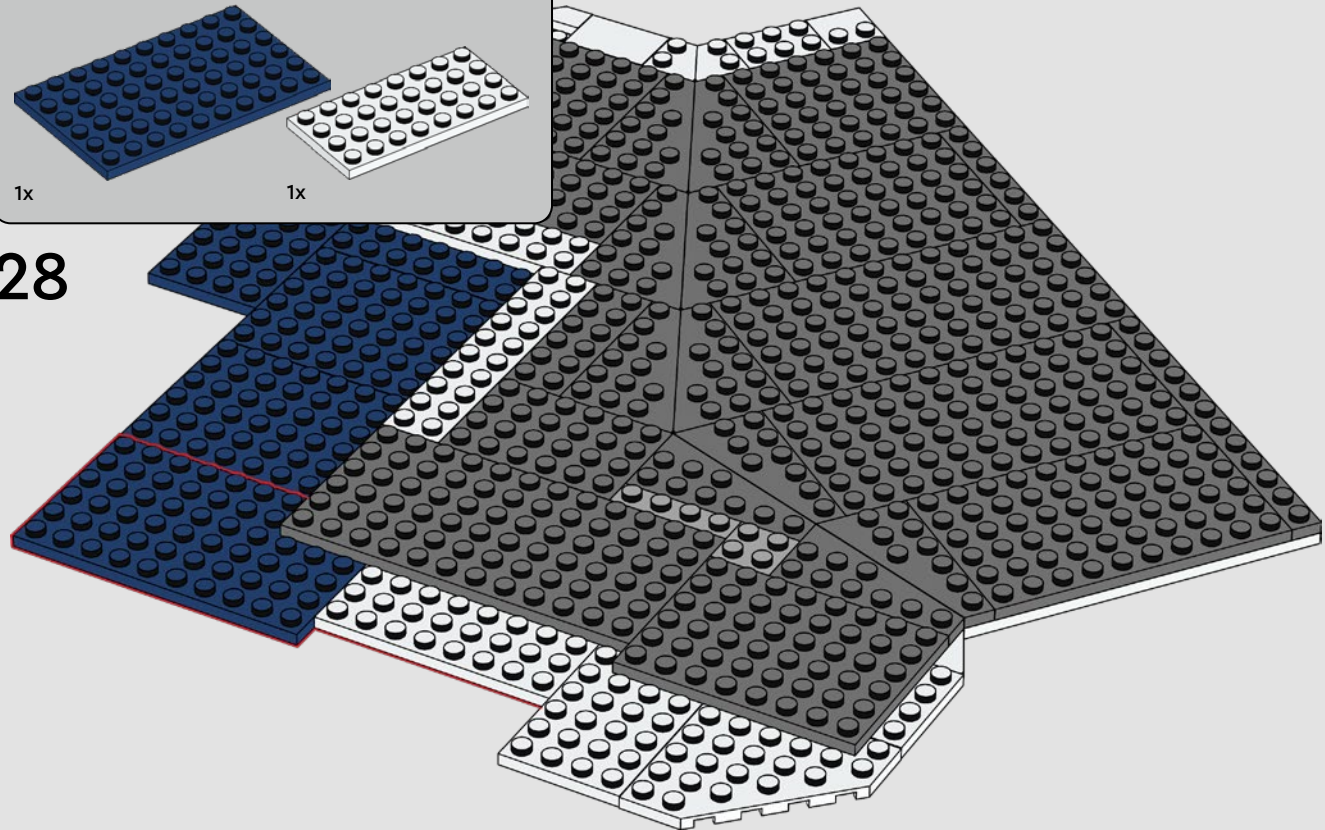

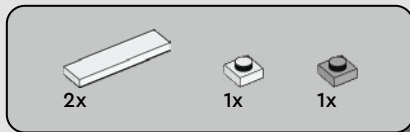

29

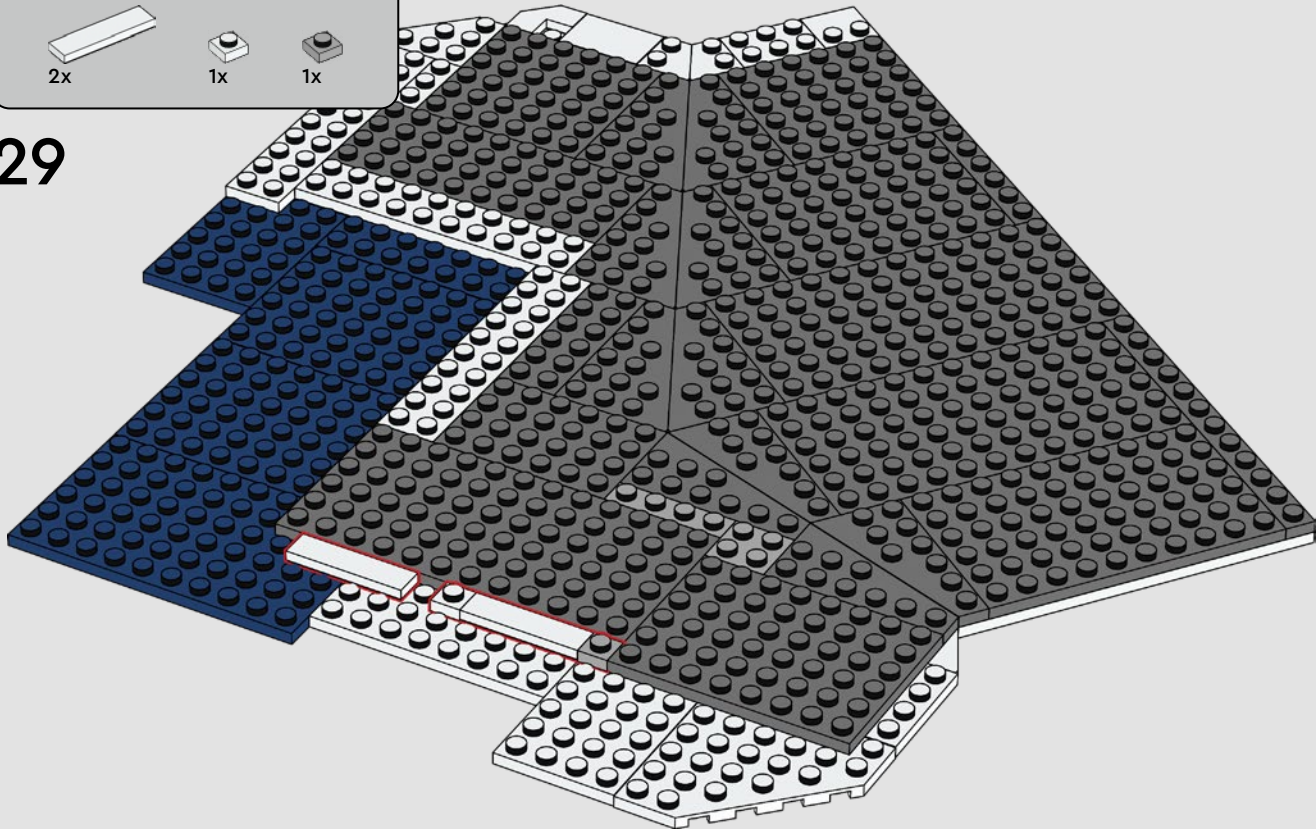

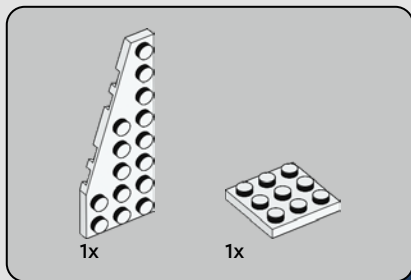

30

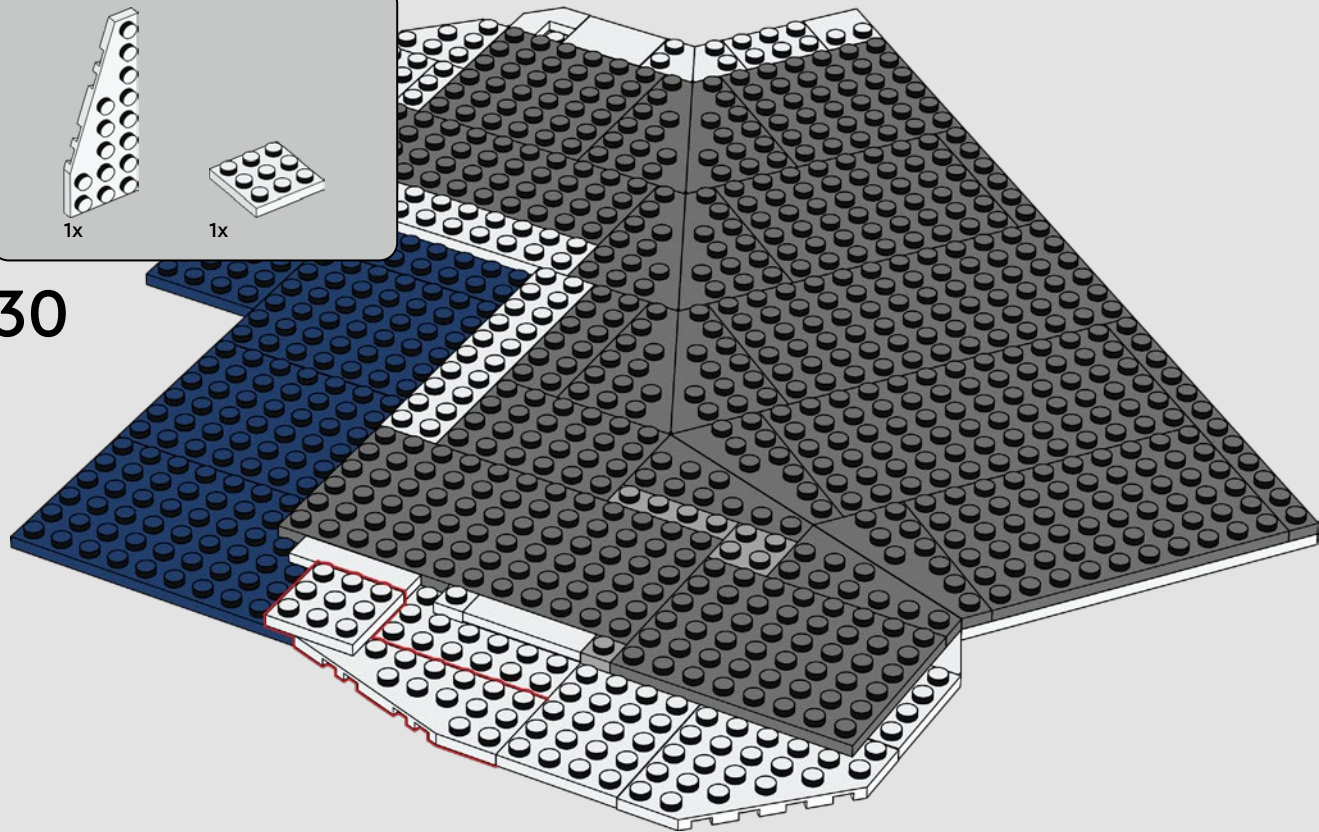

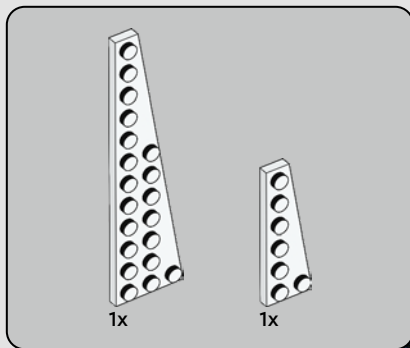

31

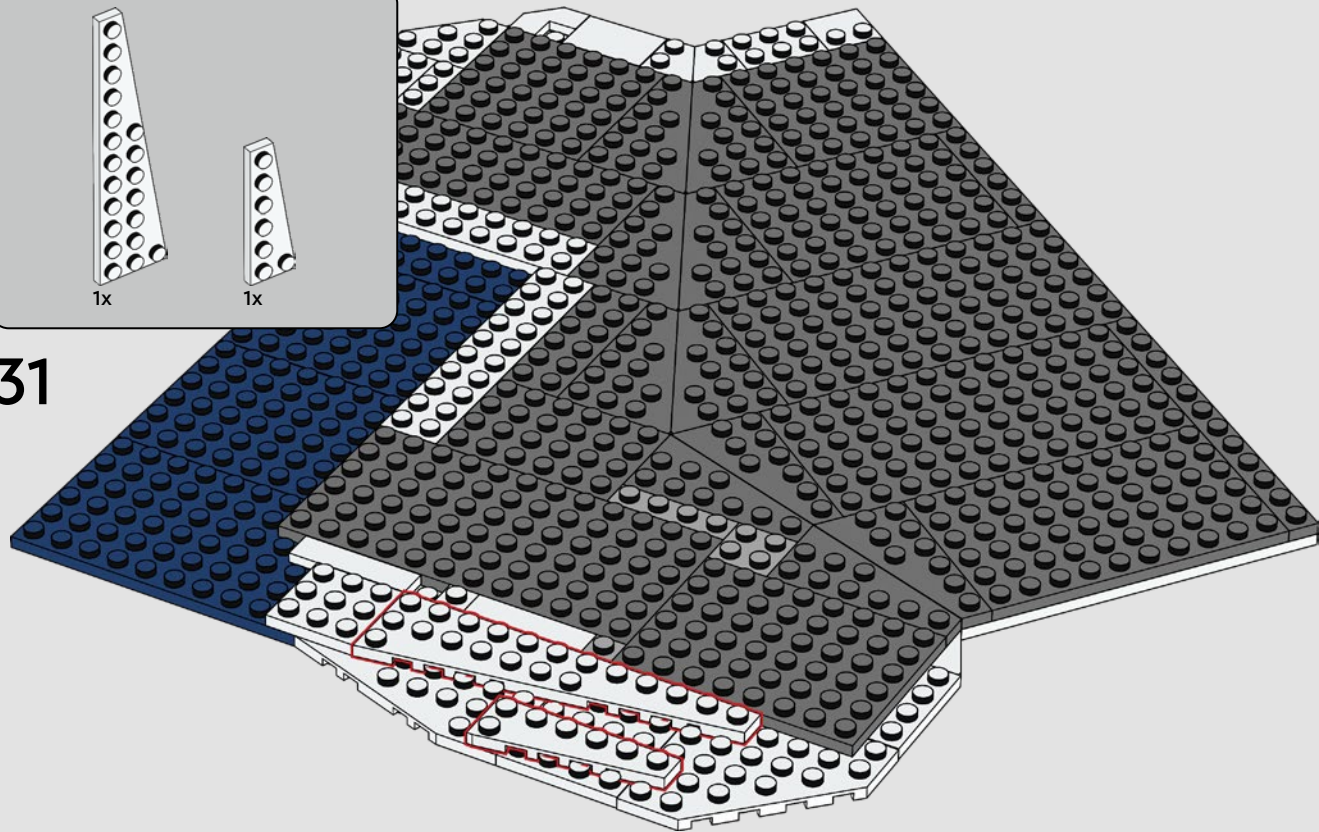

36

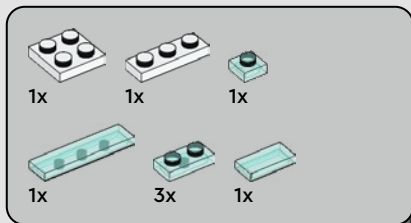

32

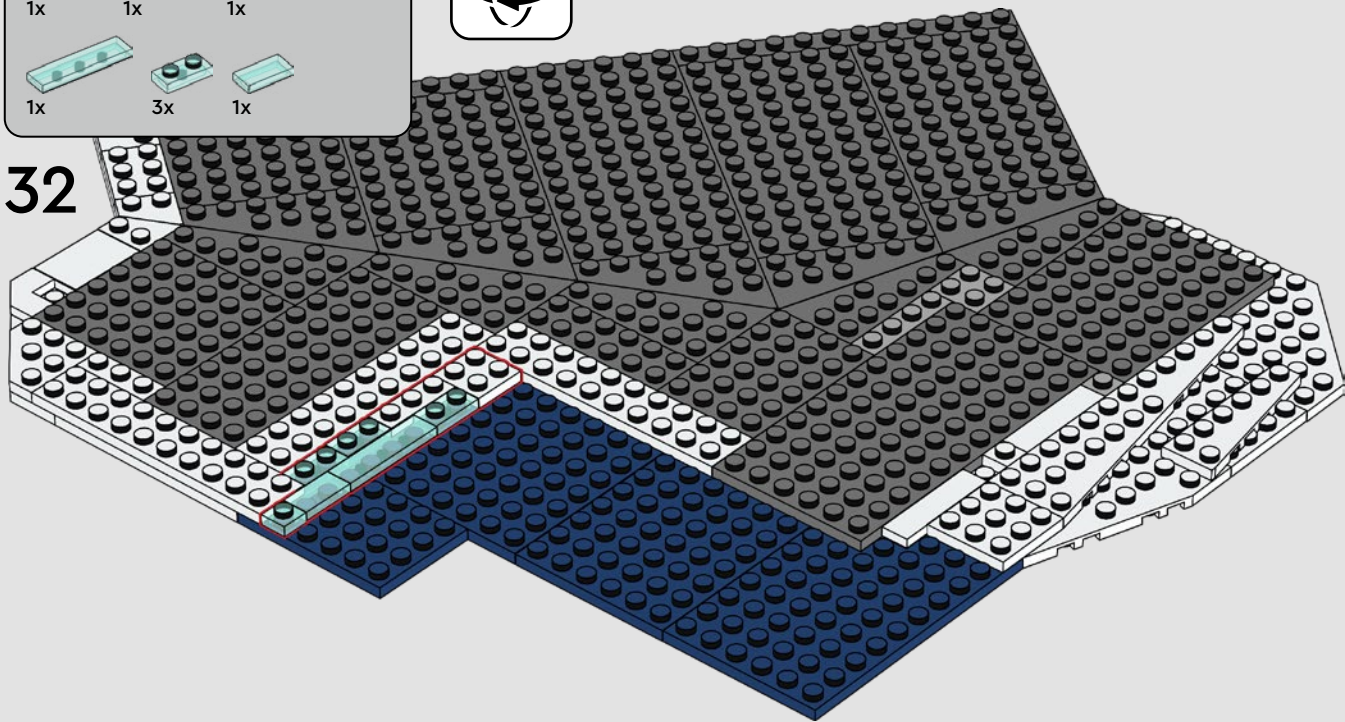

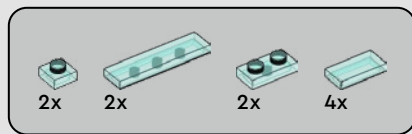

33

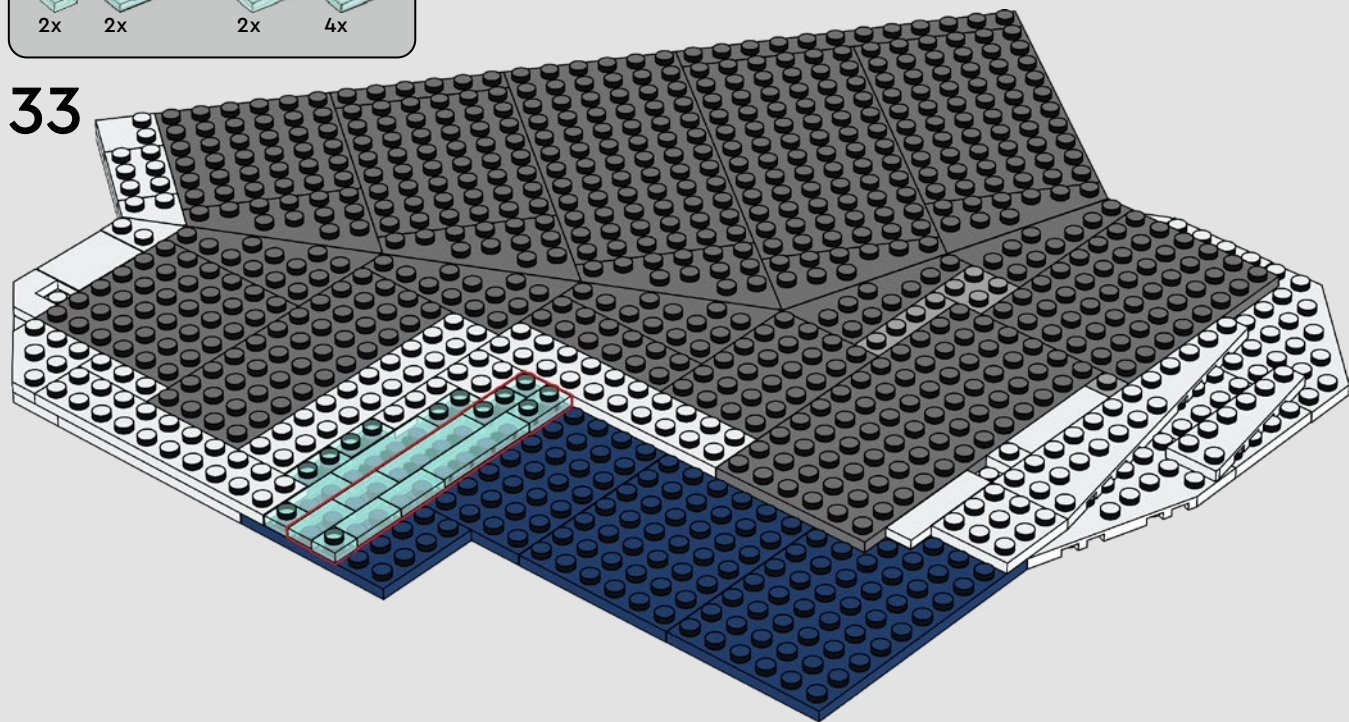

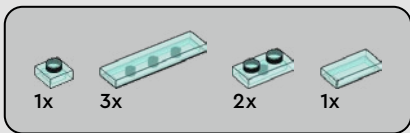

34

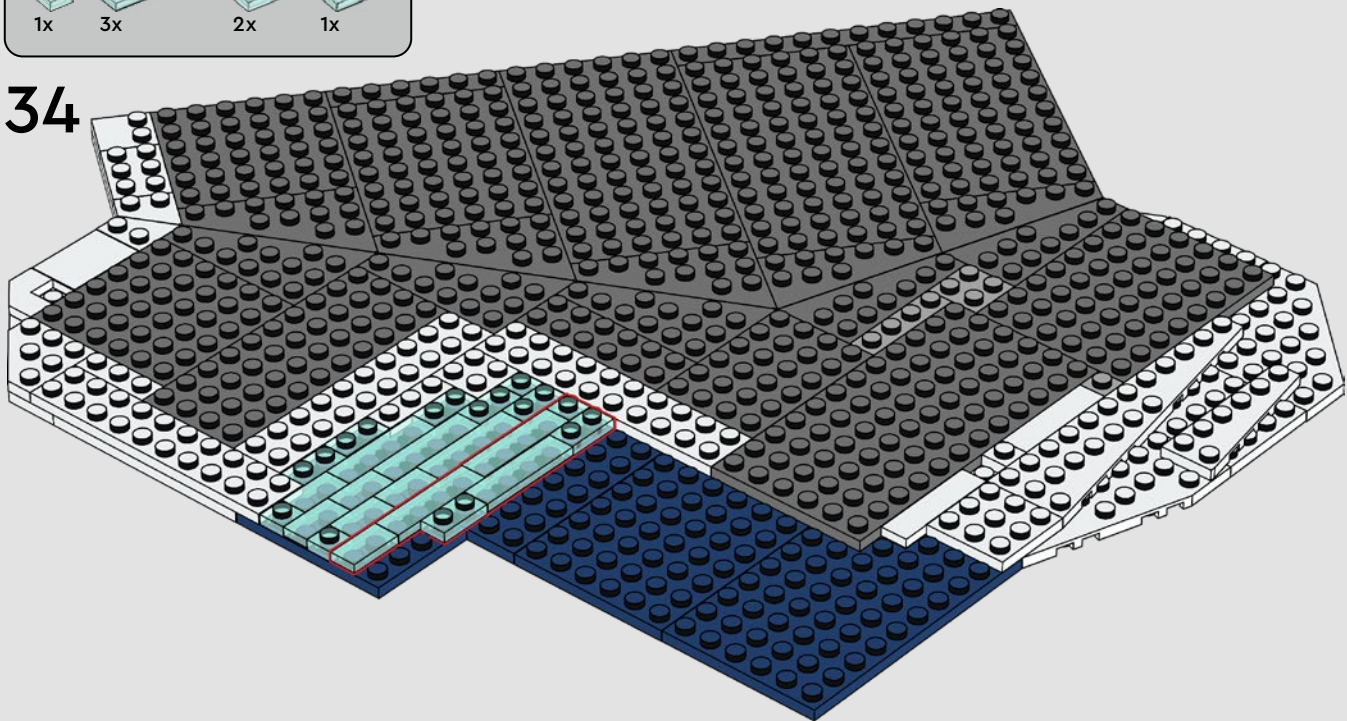

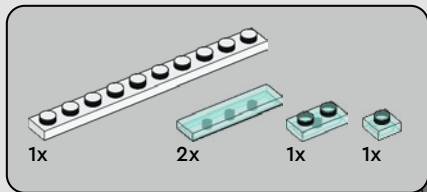

35

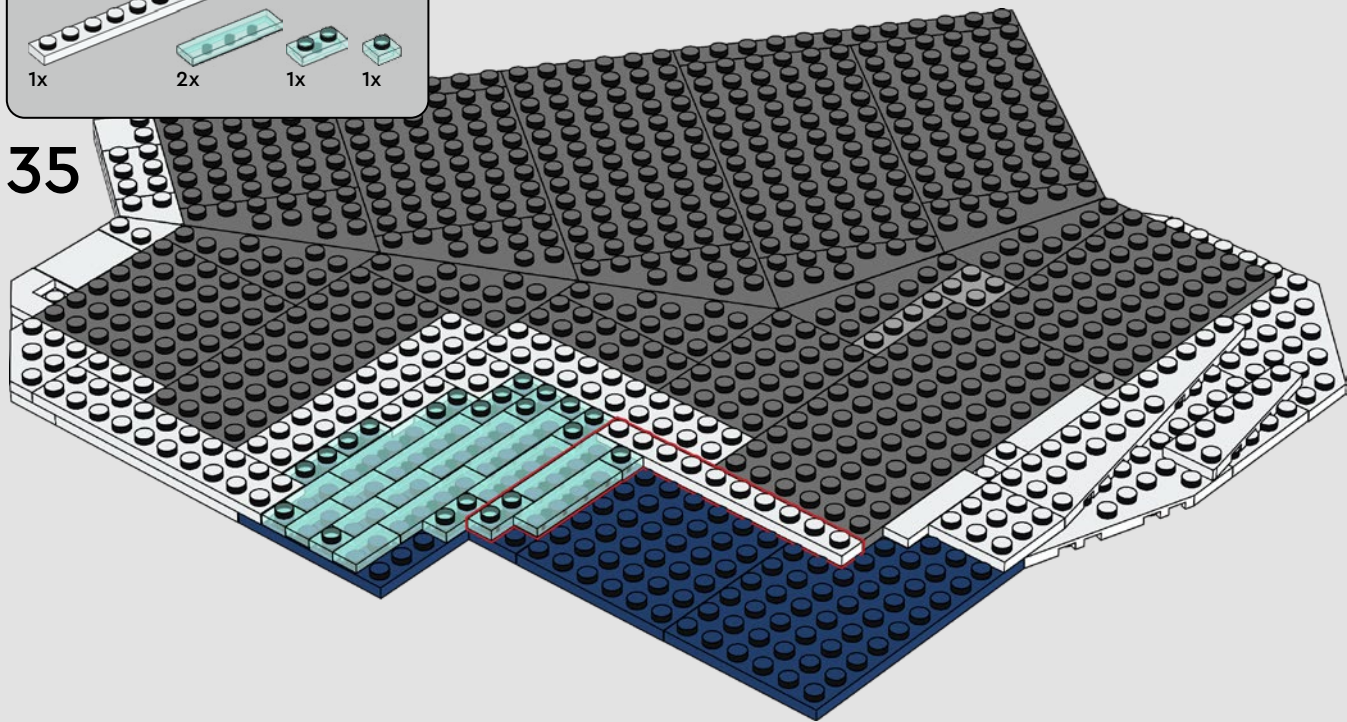

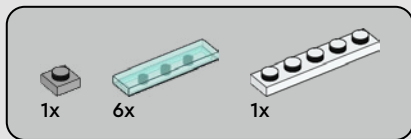

36

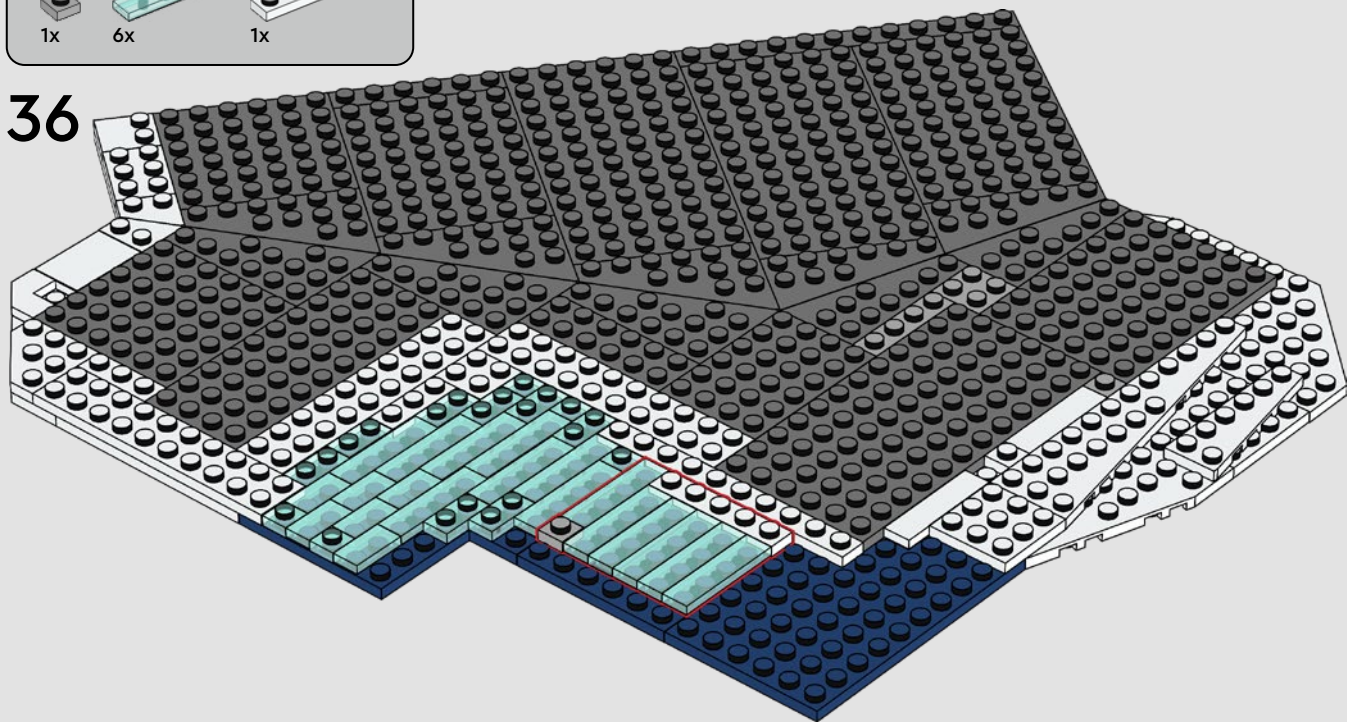



2x



3x



8x

38

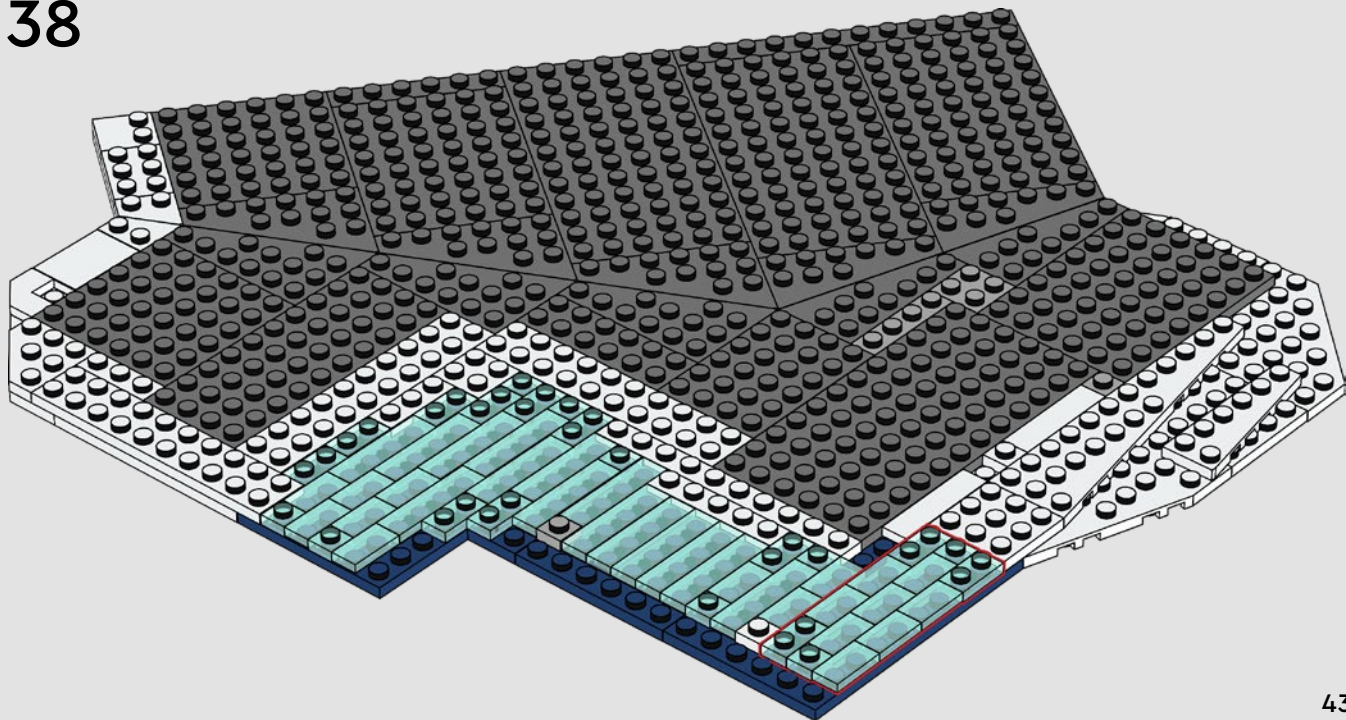

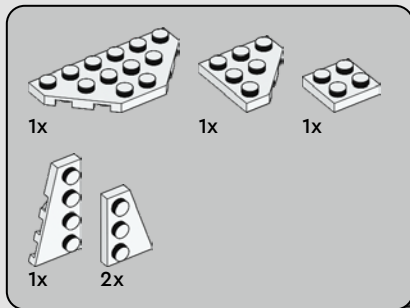

39

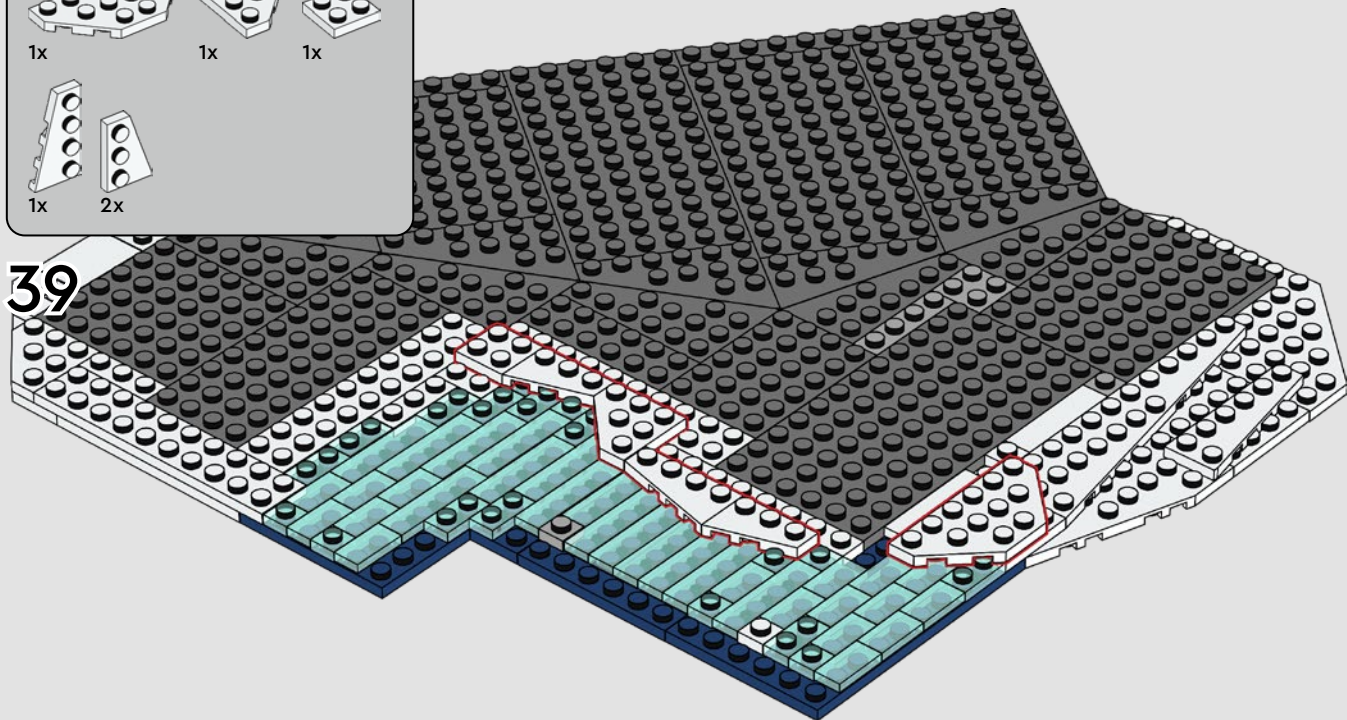

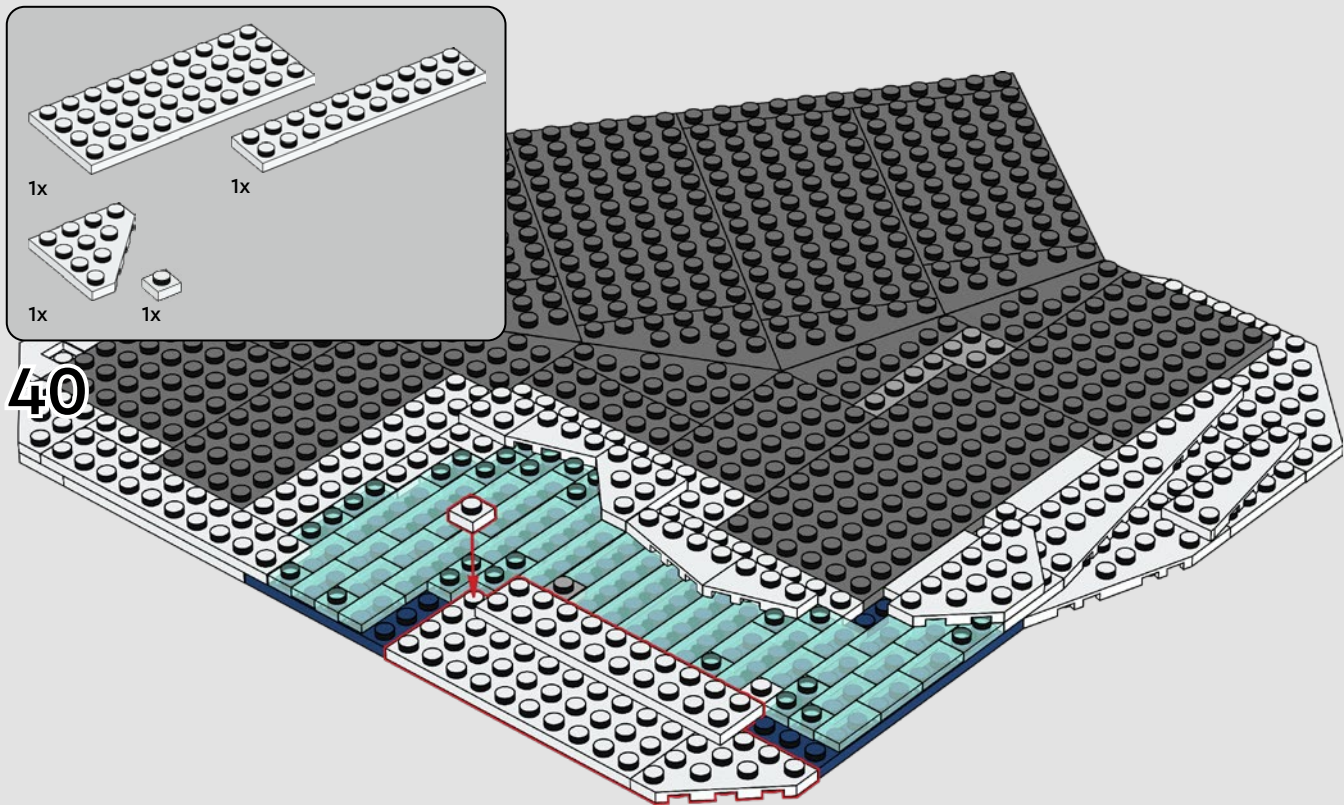

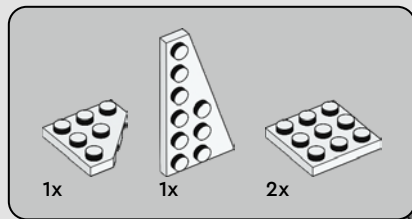

41

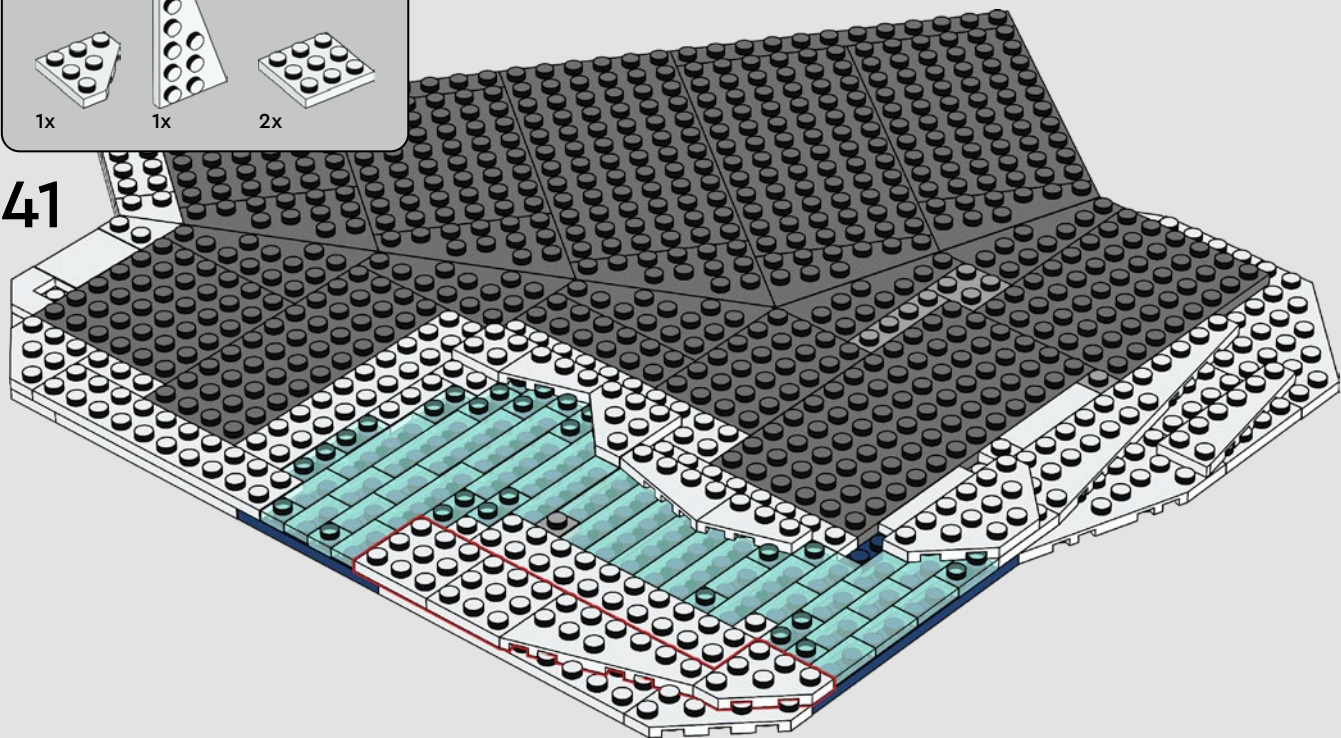

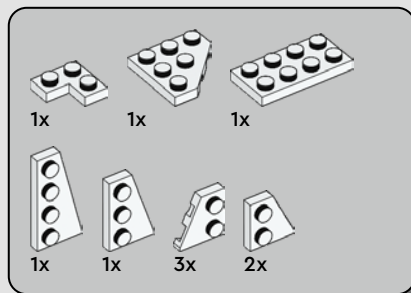

42

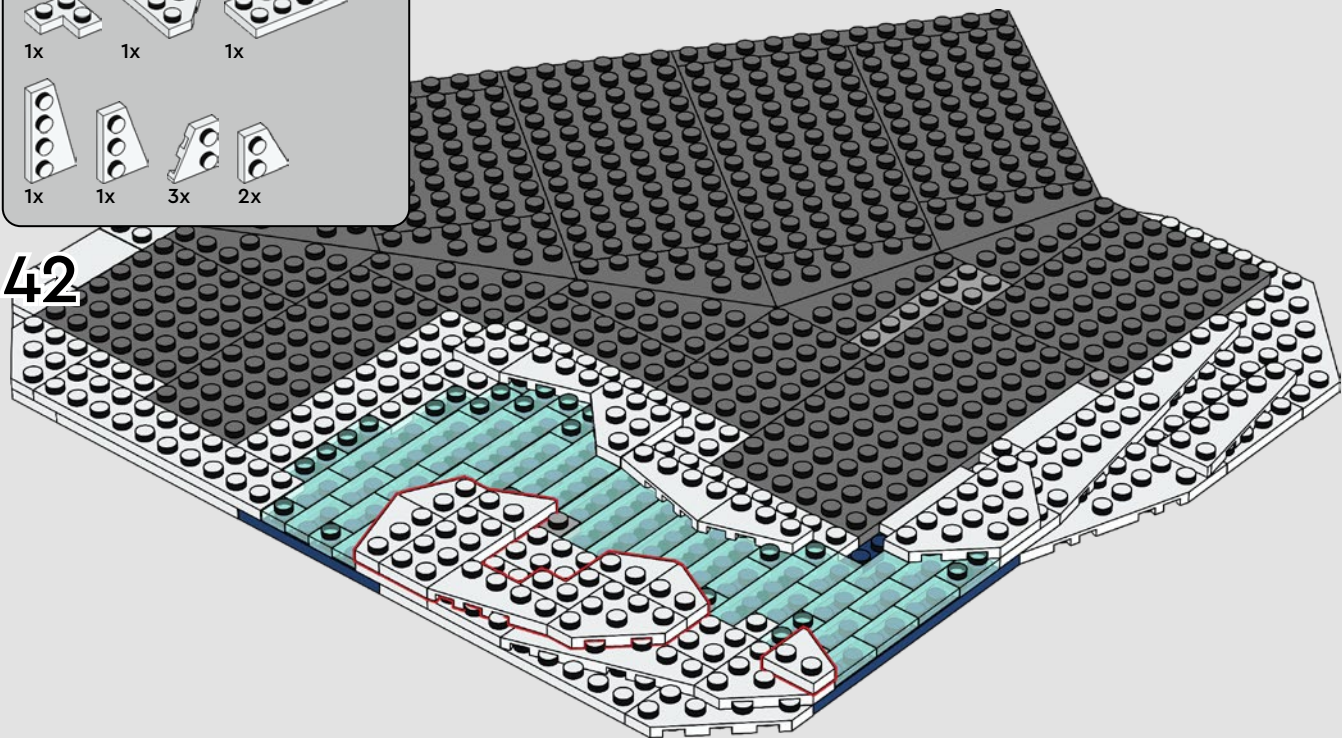

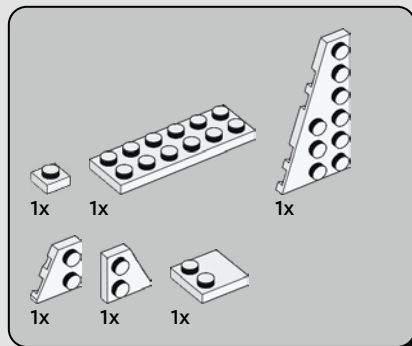

43

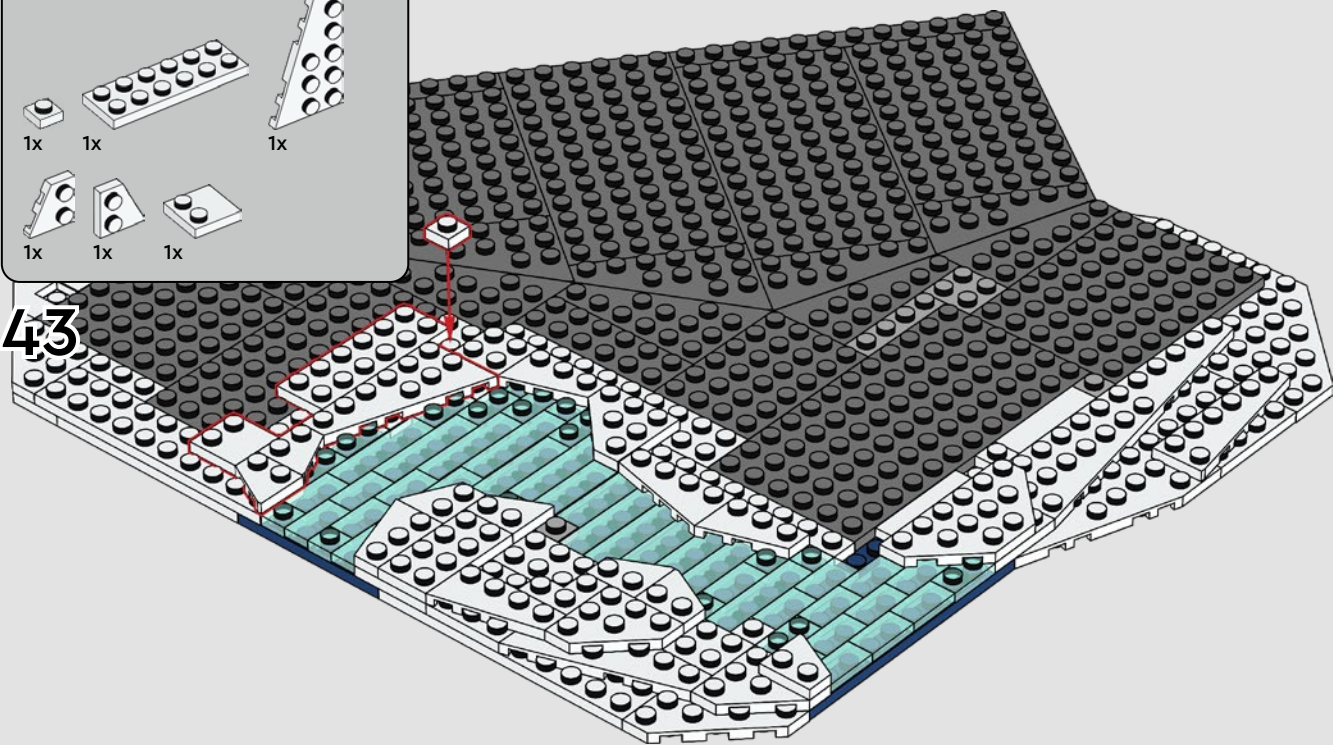

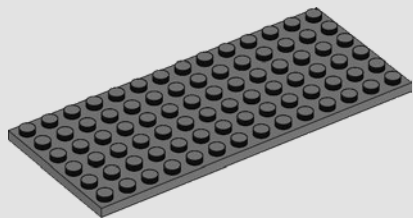
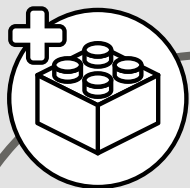

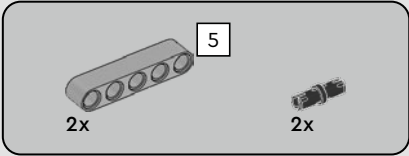
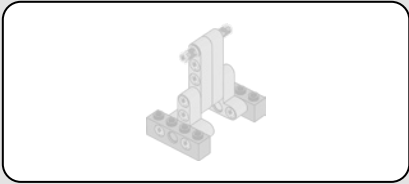

44

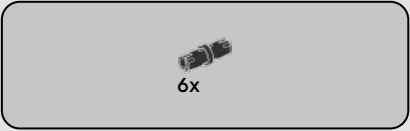
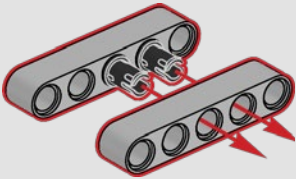

45

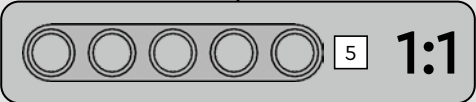
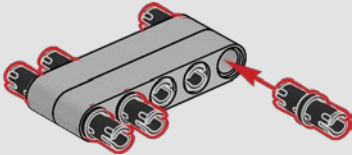

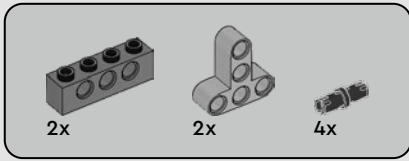

46

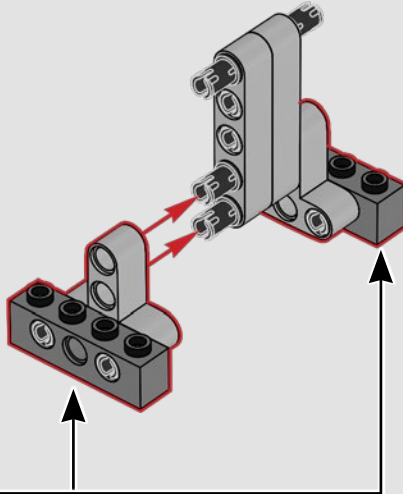
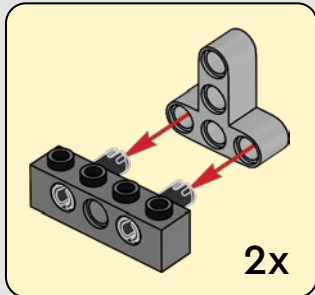

47

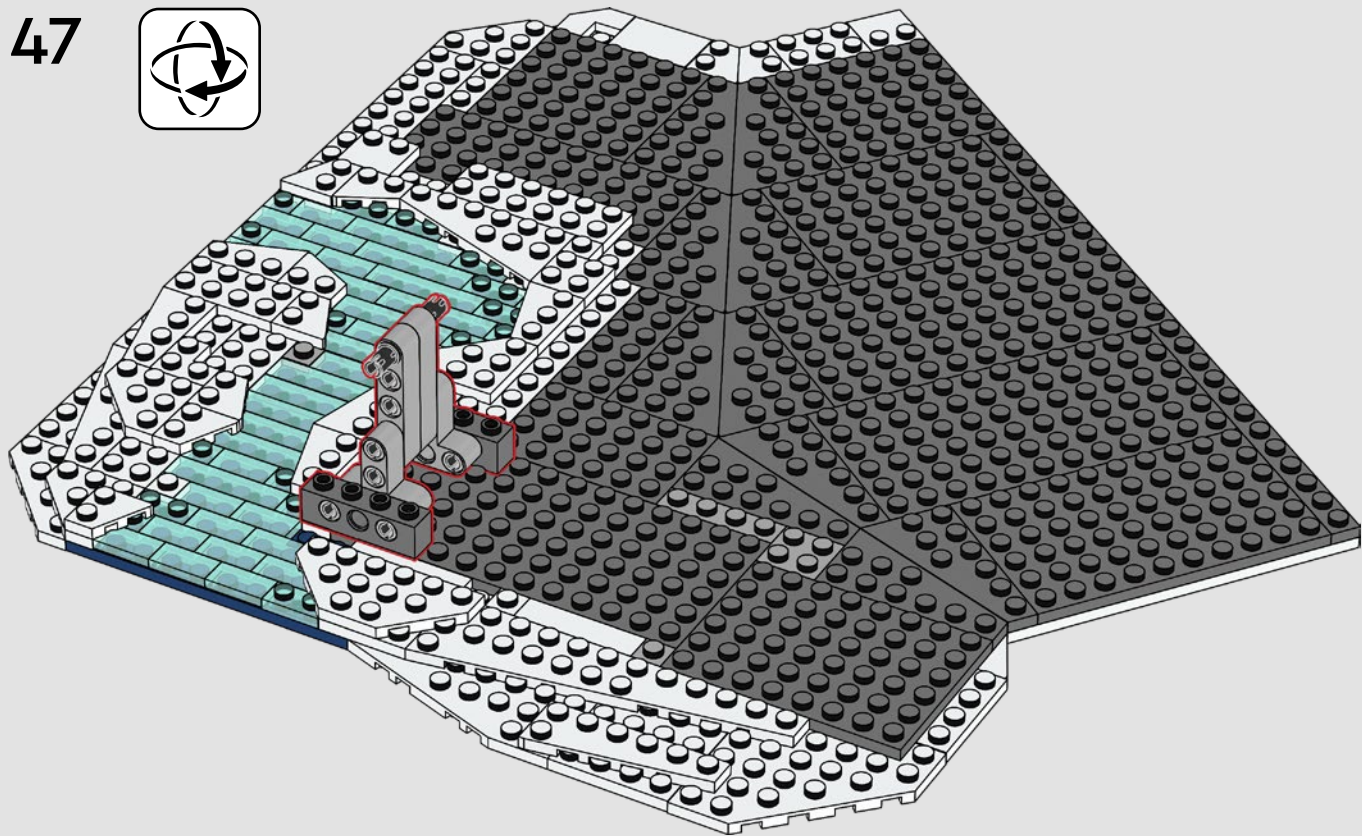
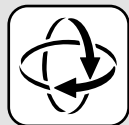

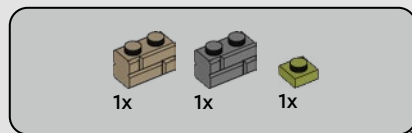

48

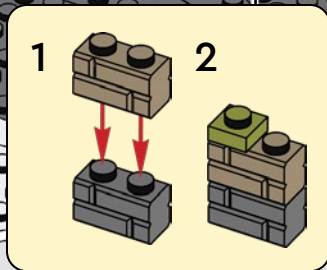
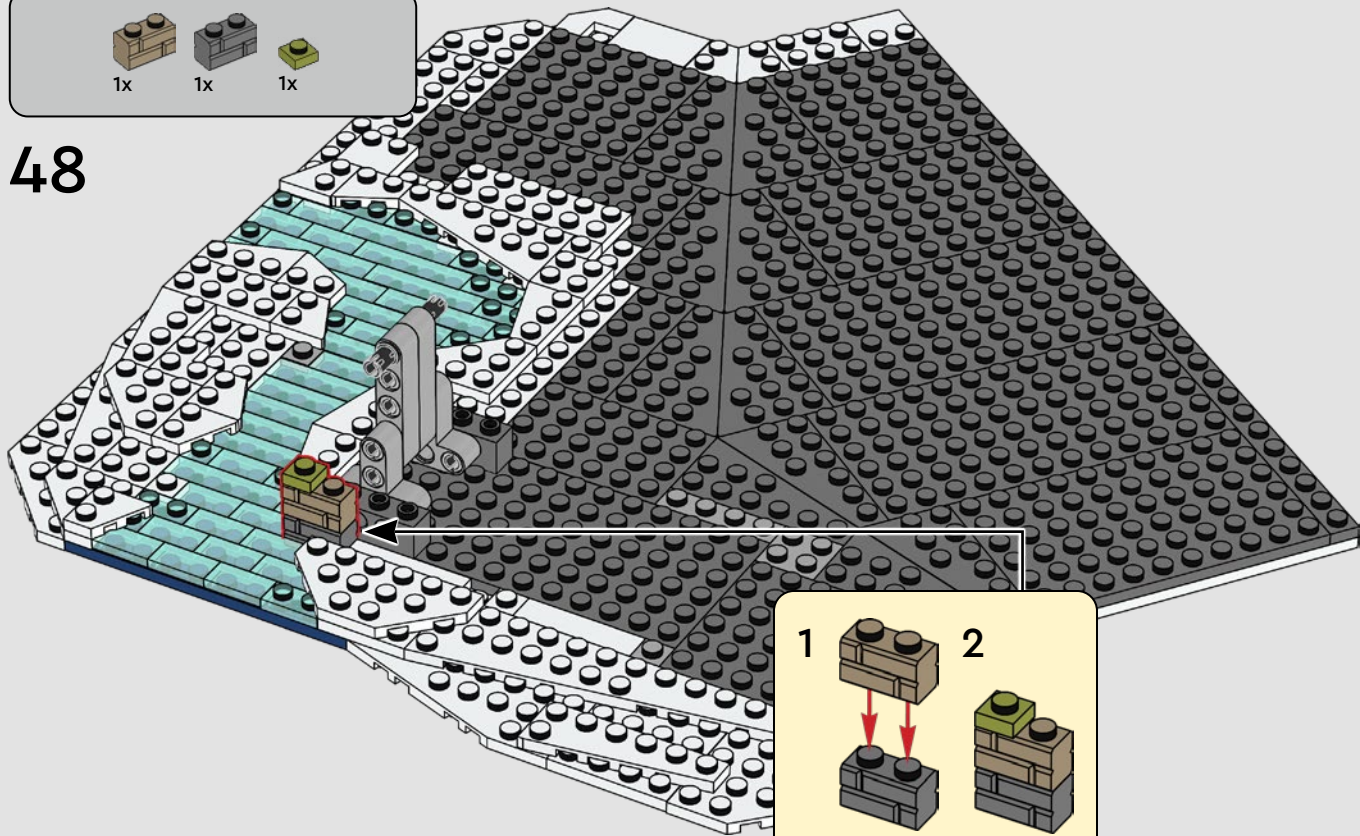

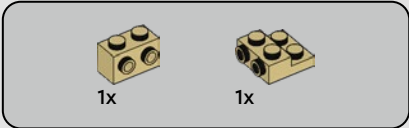
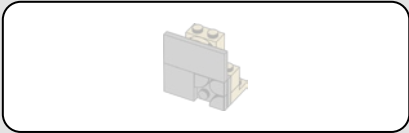

49

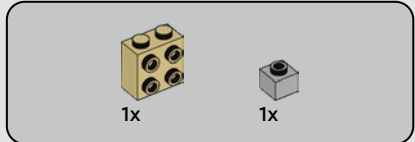
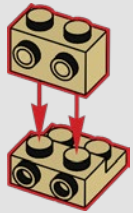

50

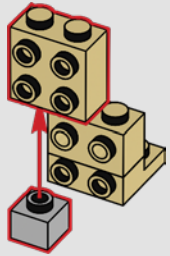

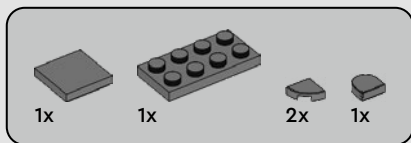

51

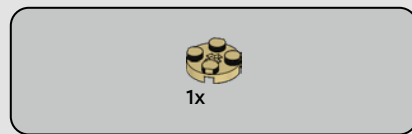
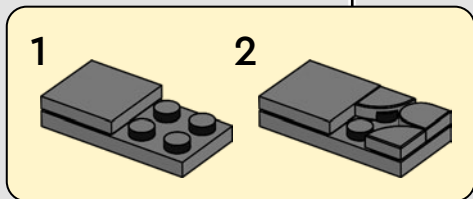
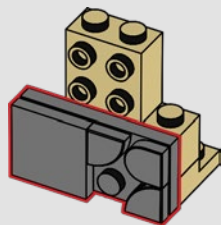

52

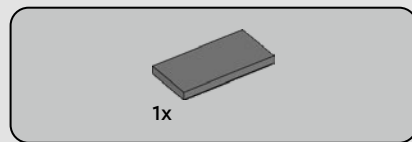
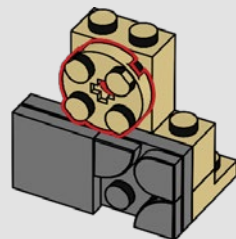

53

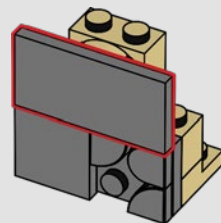

54

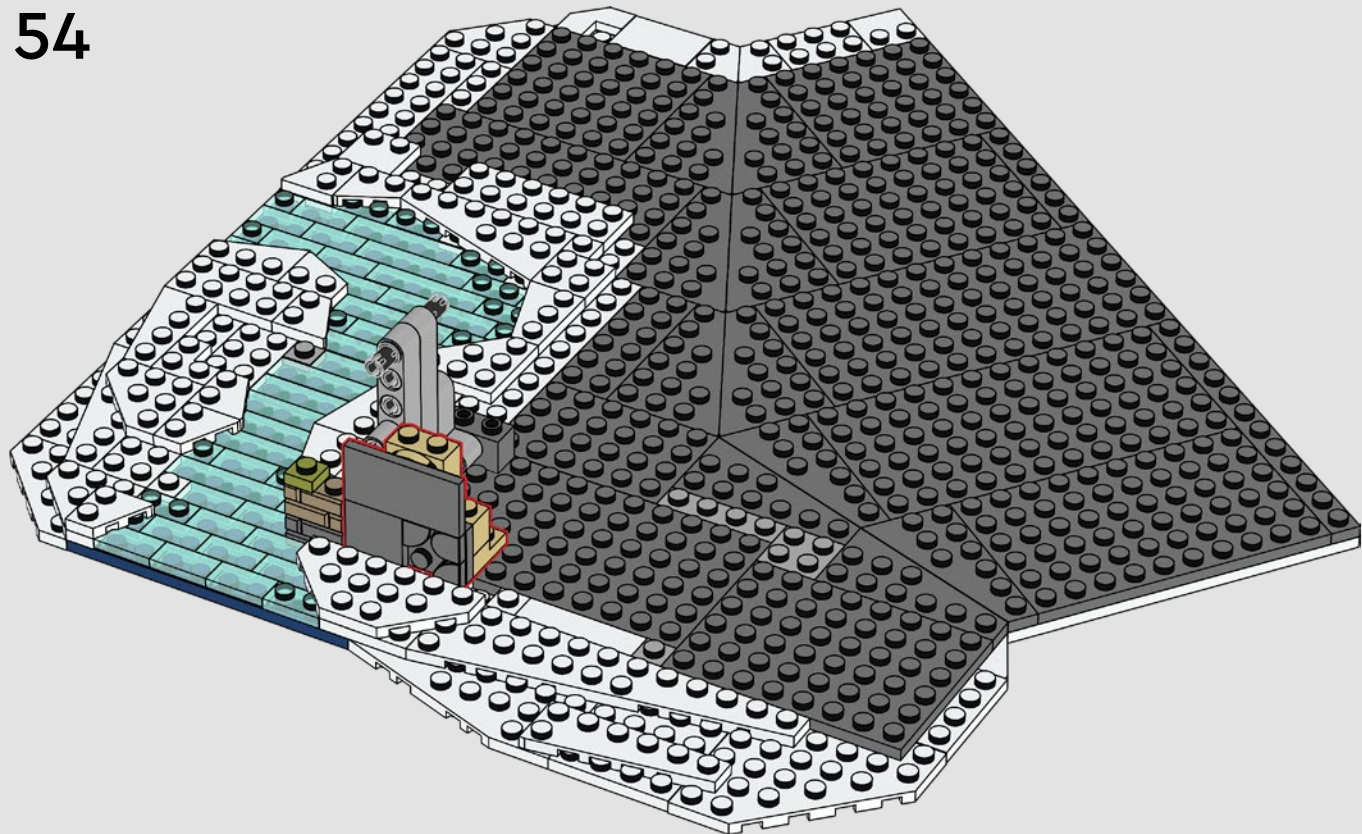

56



1x



1x

55

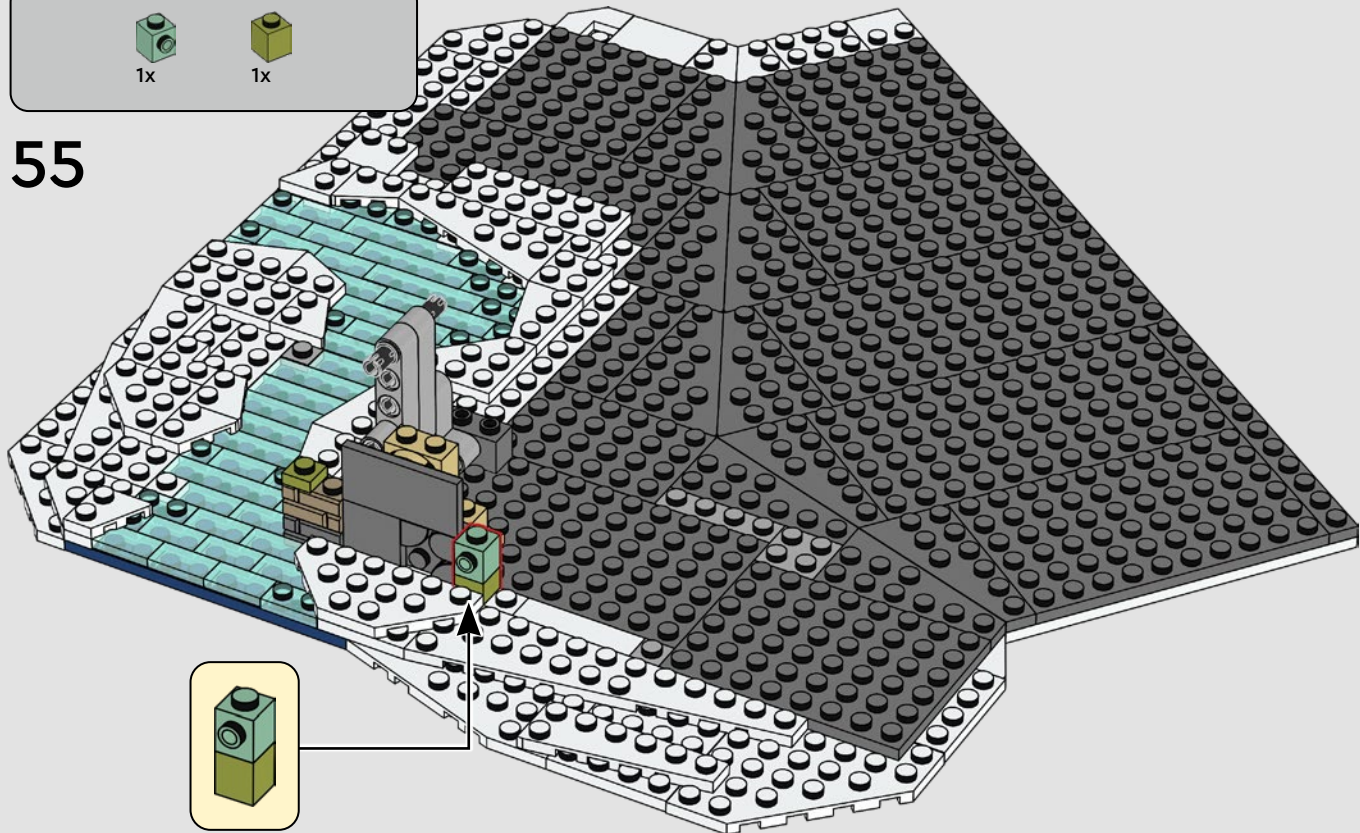

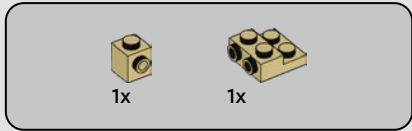
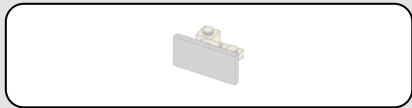

56

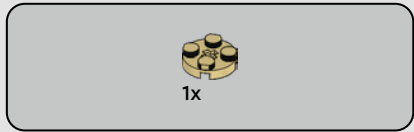
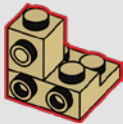

57

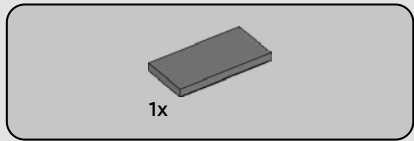
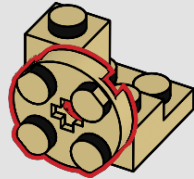

58

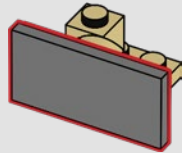

59

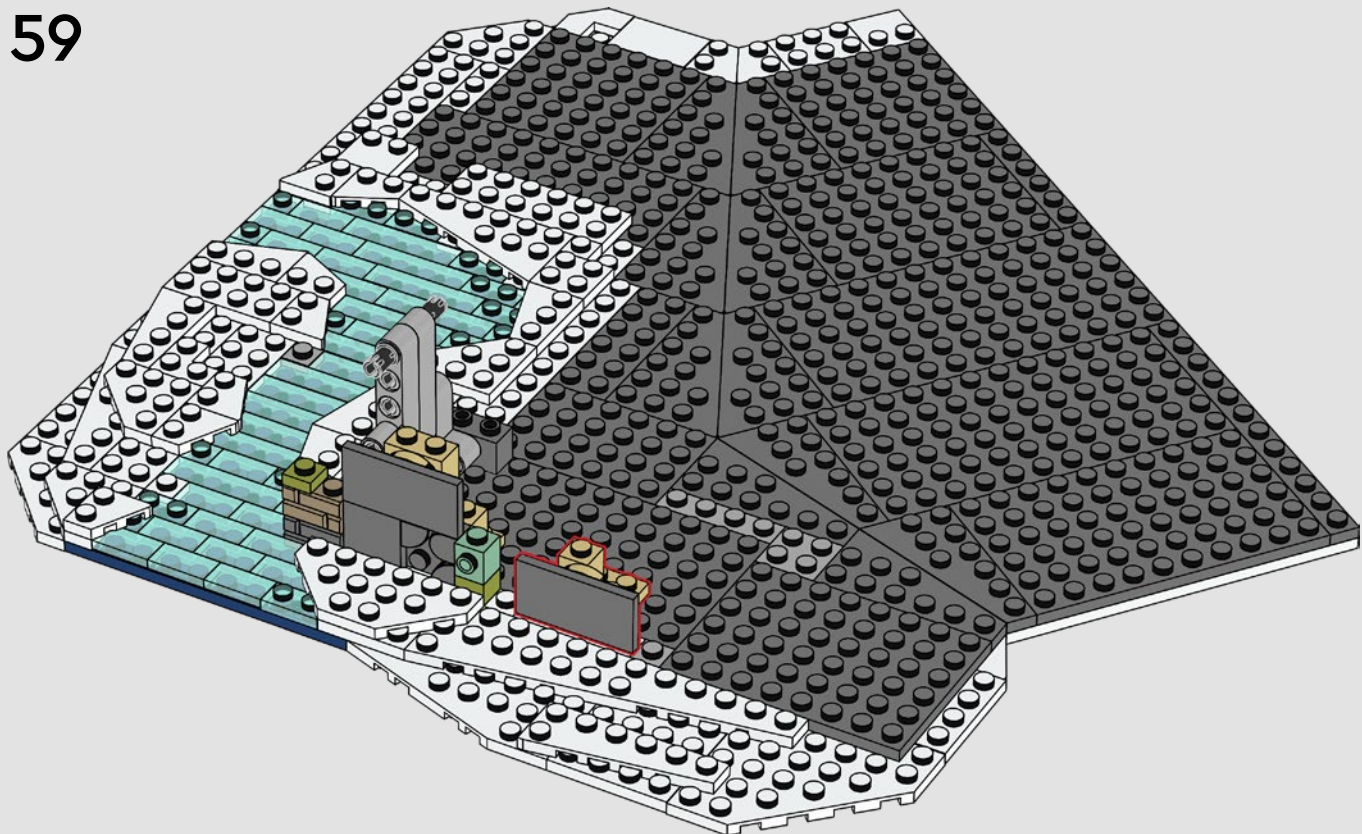

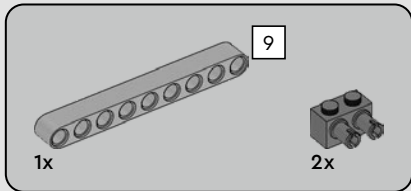
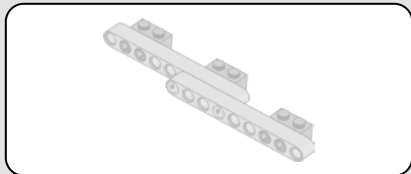

60

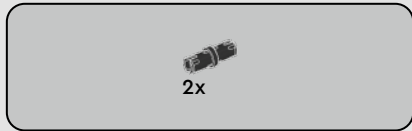
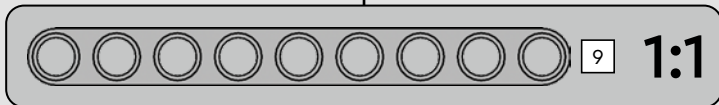
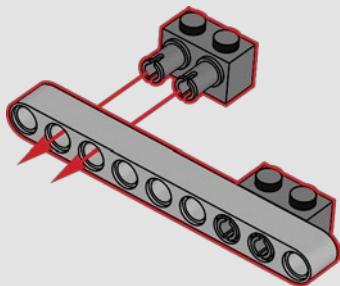

61

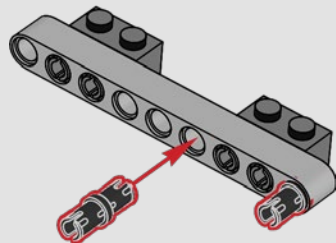

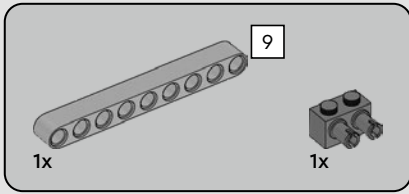

62

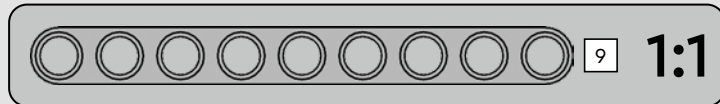
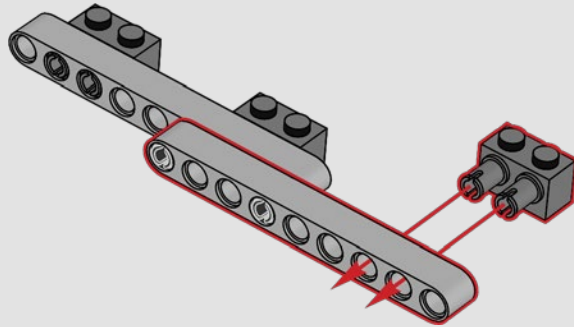

63

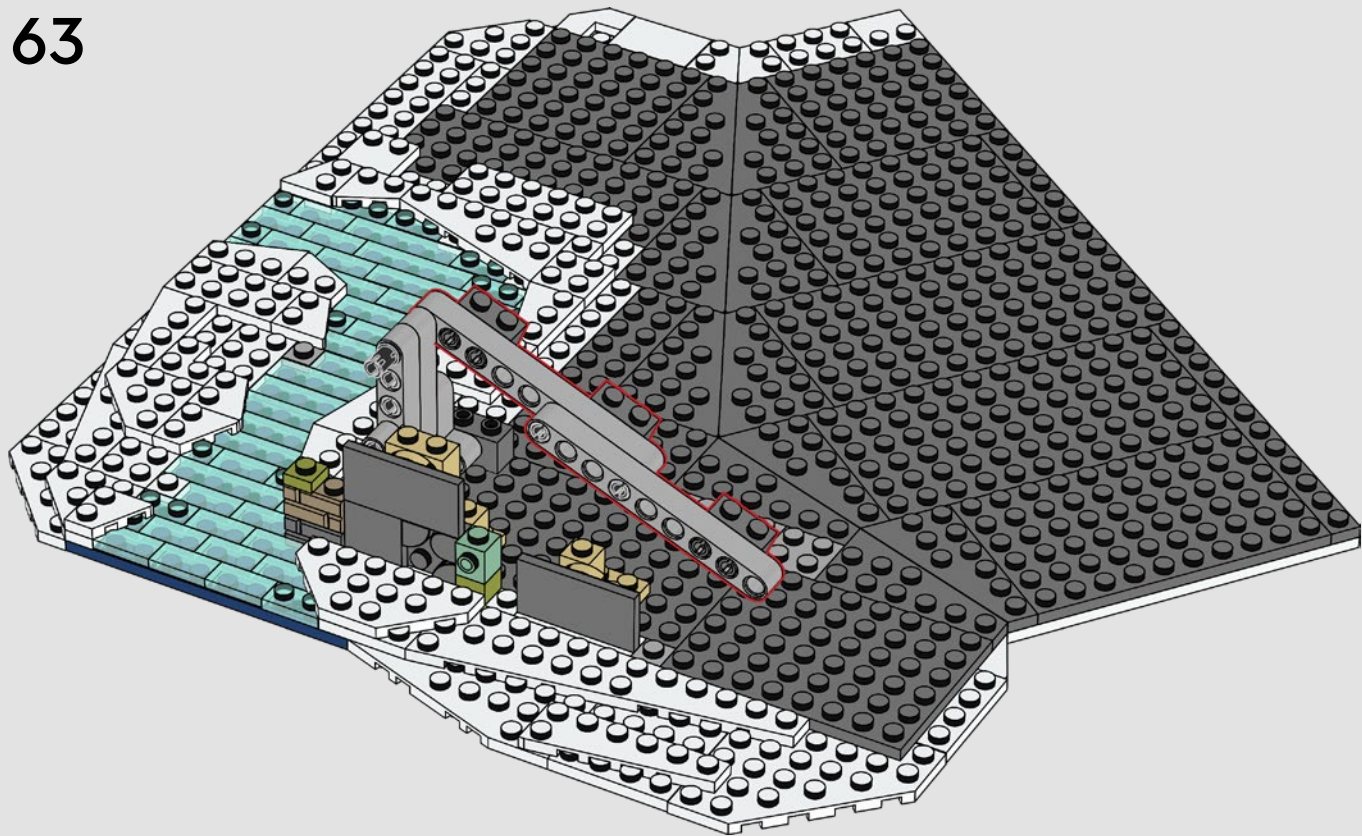

62

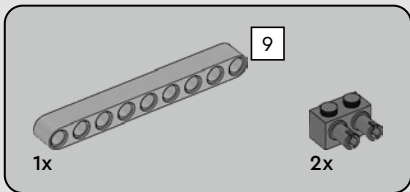
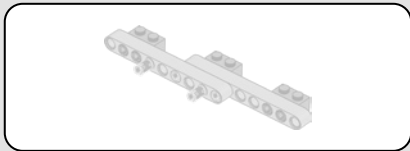

64

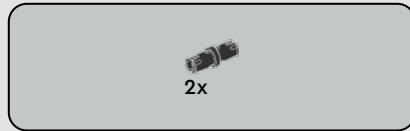
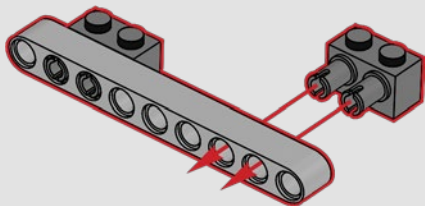

65

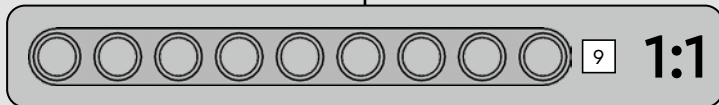
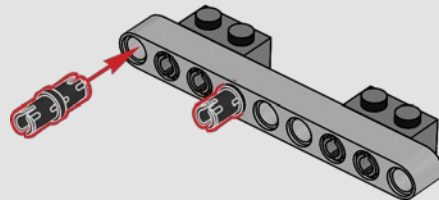

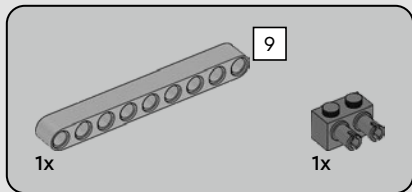

66

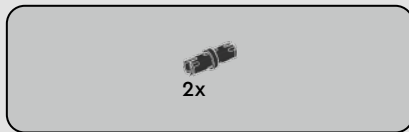
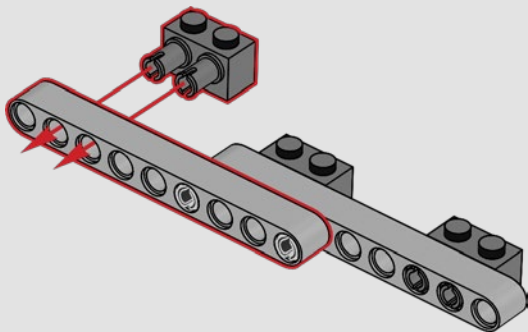

67

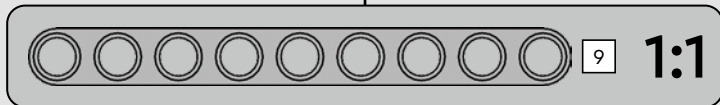
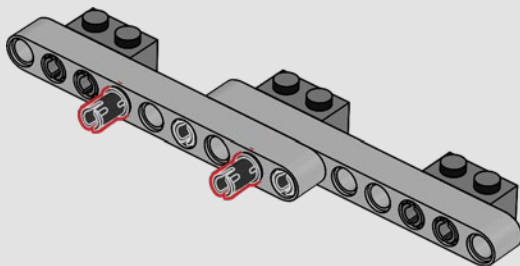

64

68

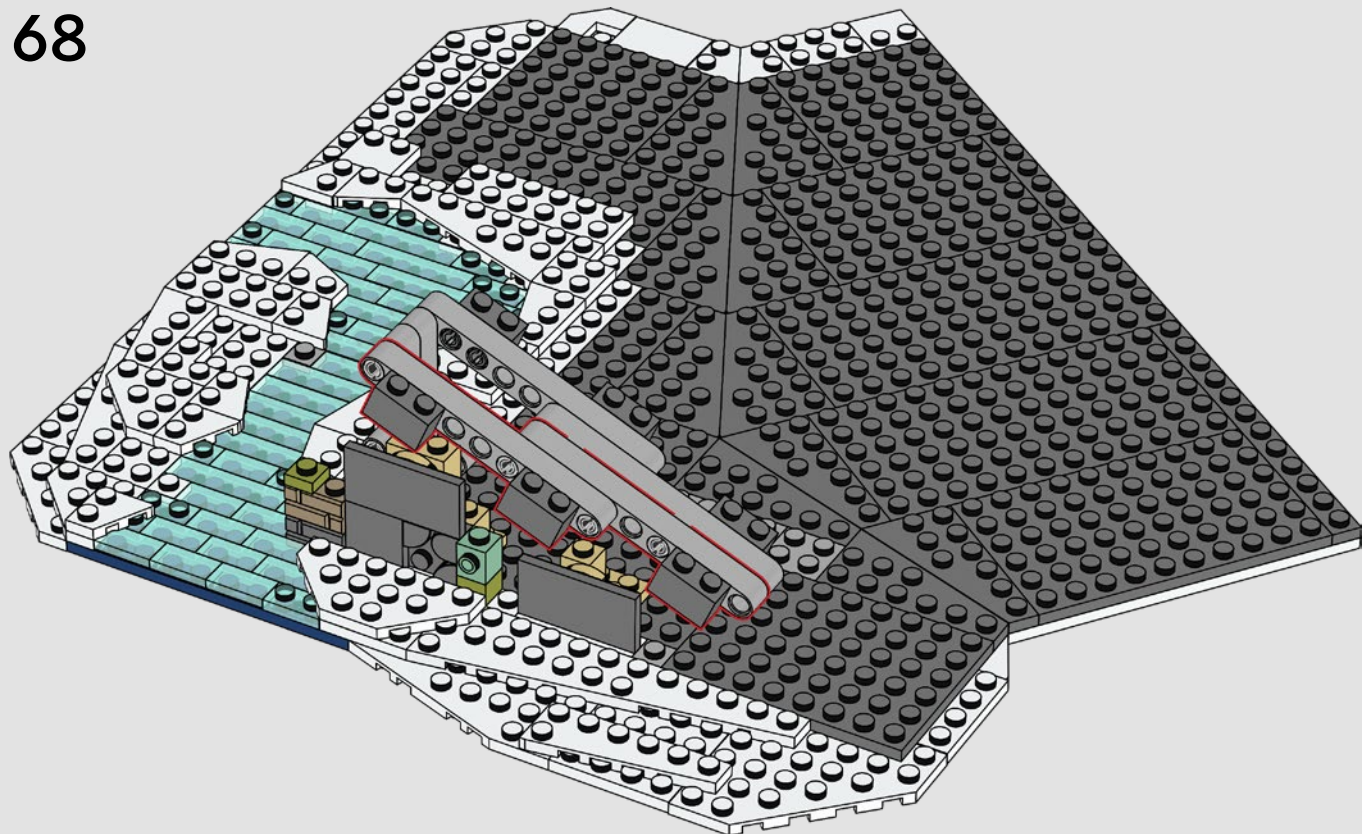

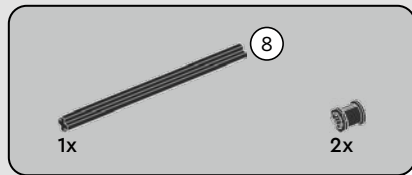

69

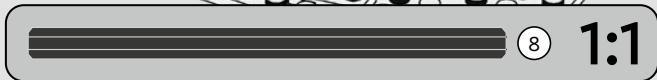
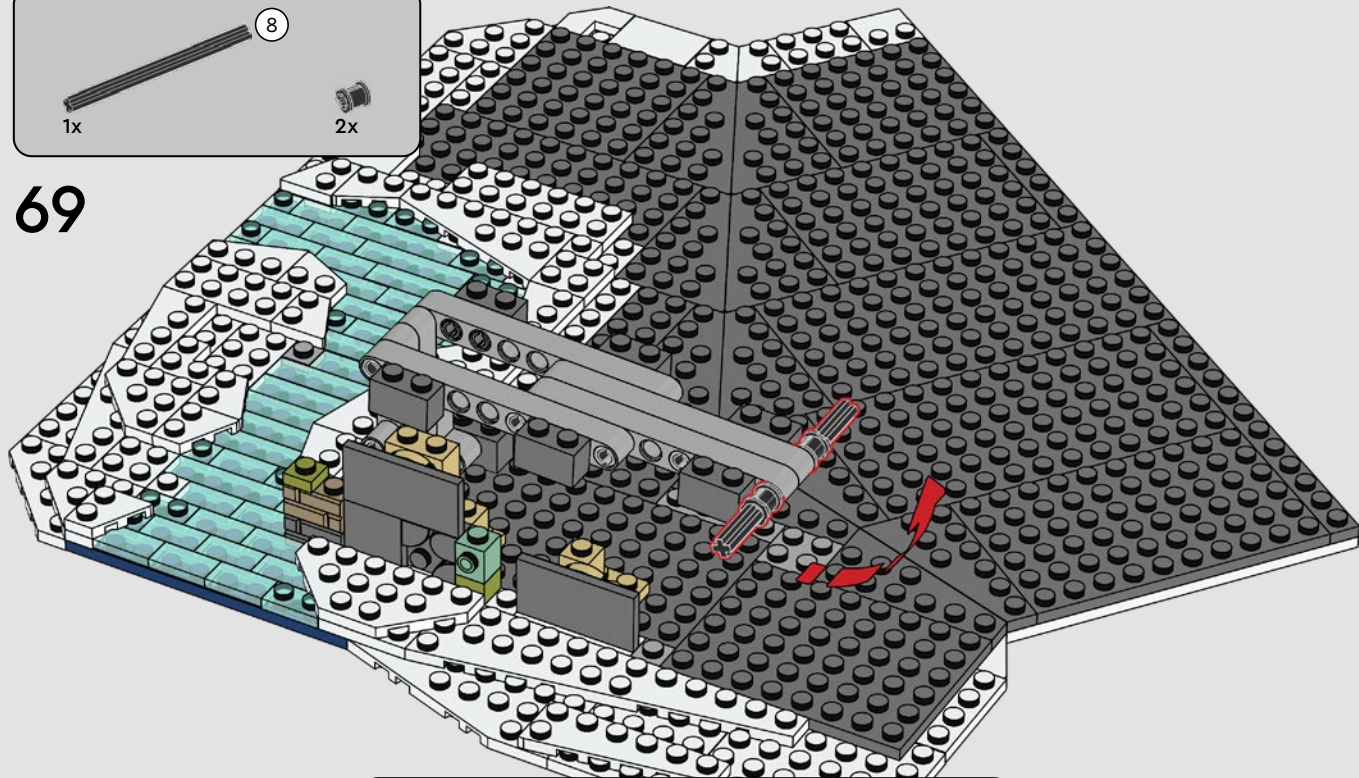



2x

70

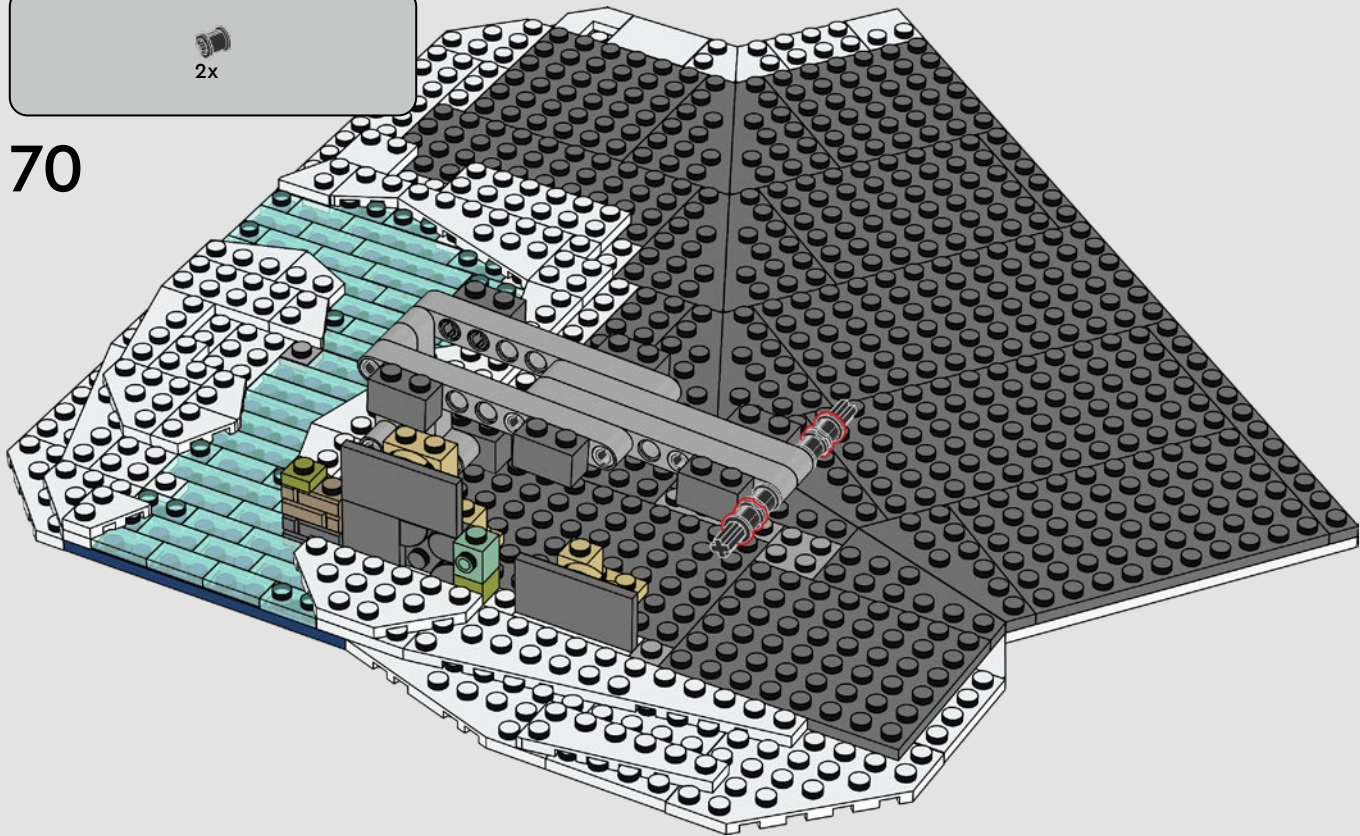



2x

71

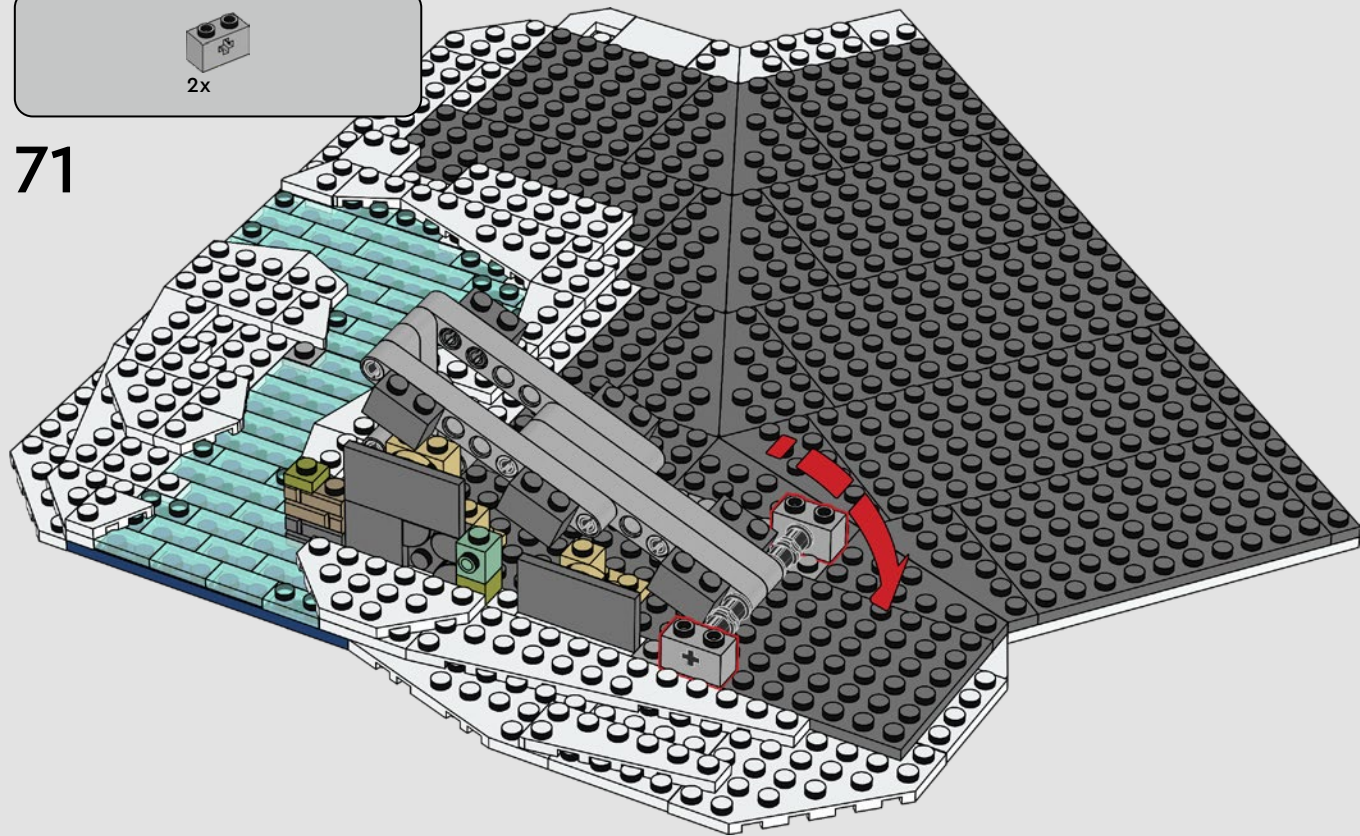

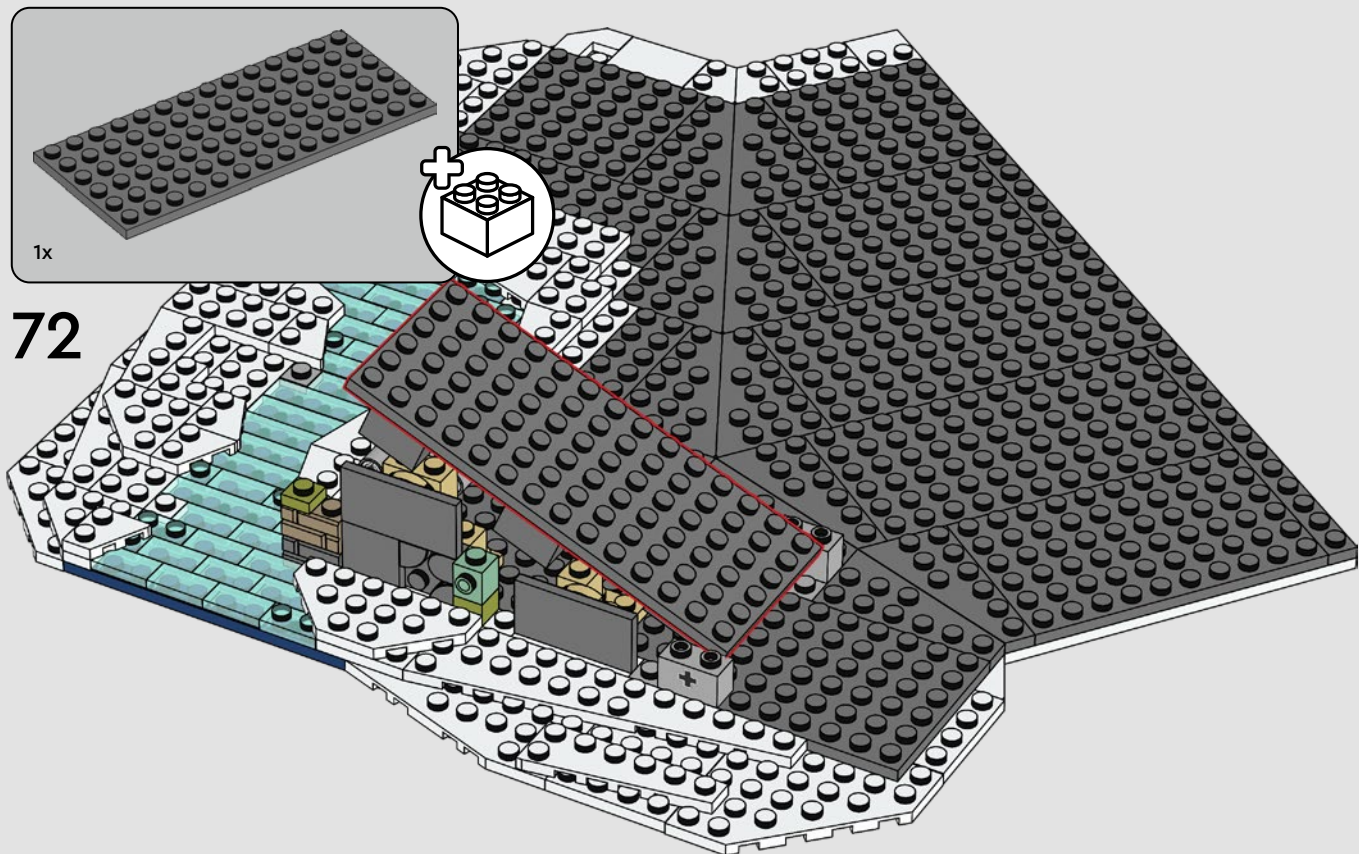

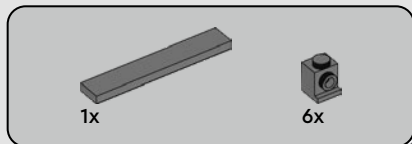

73

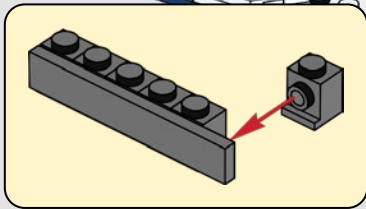
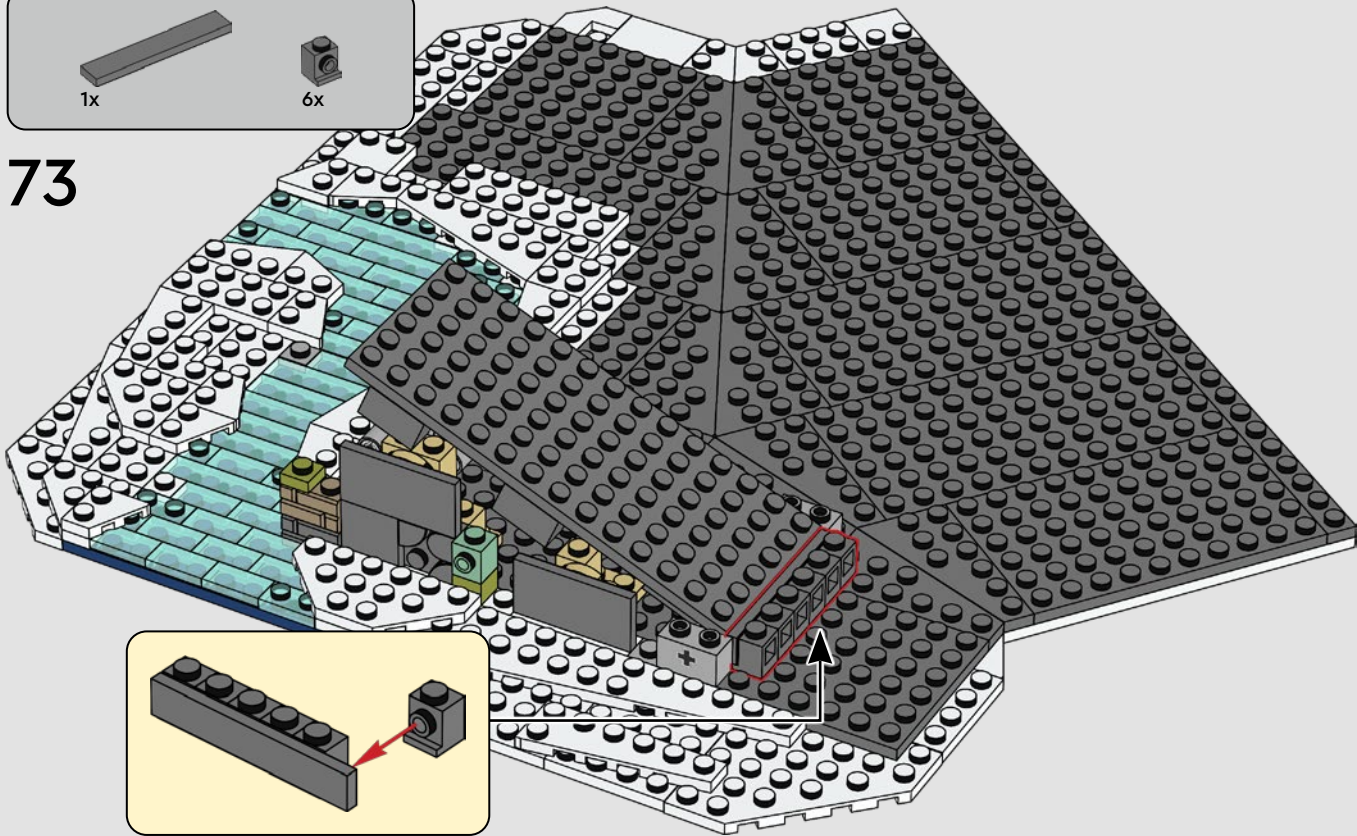

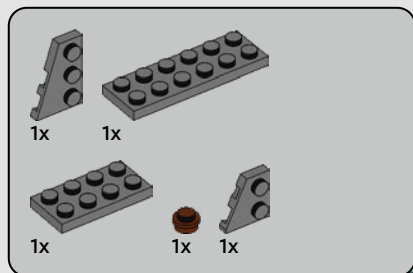

74

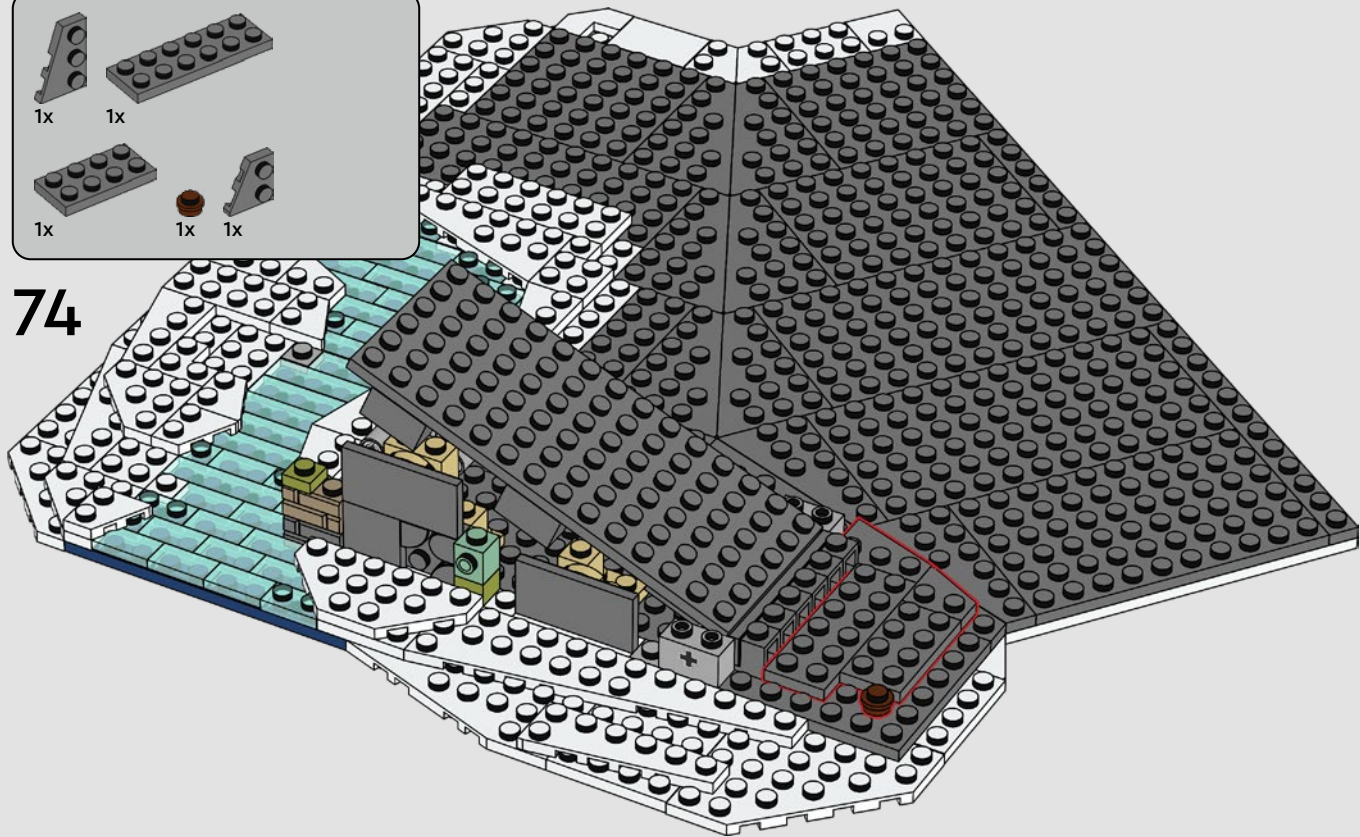

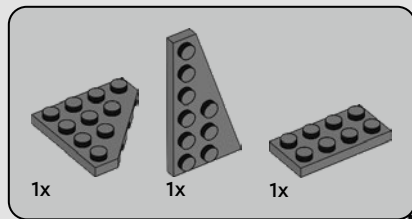

75

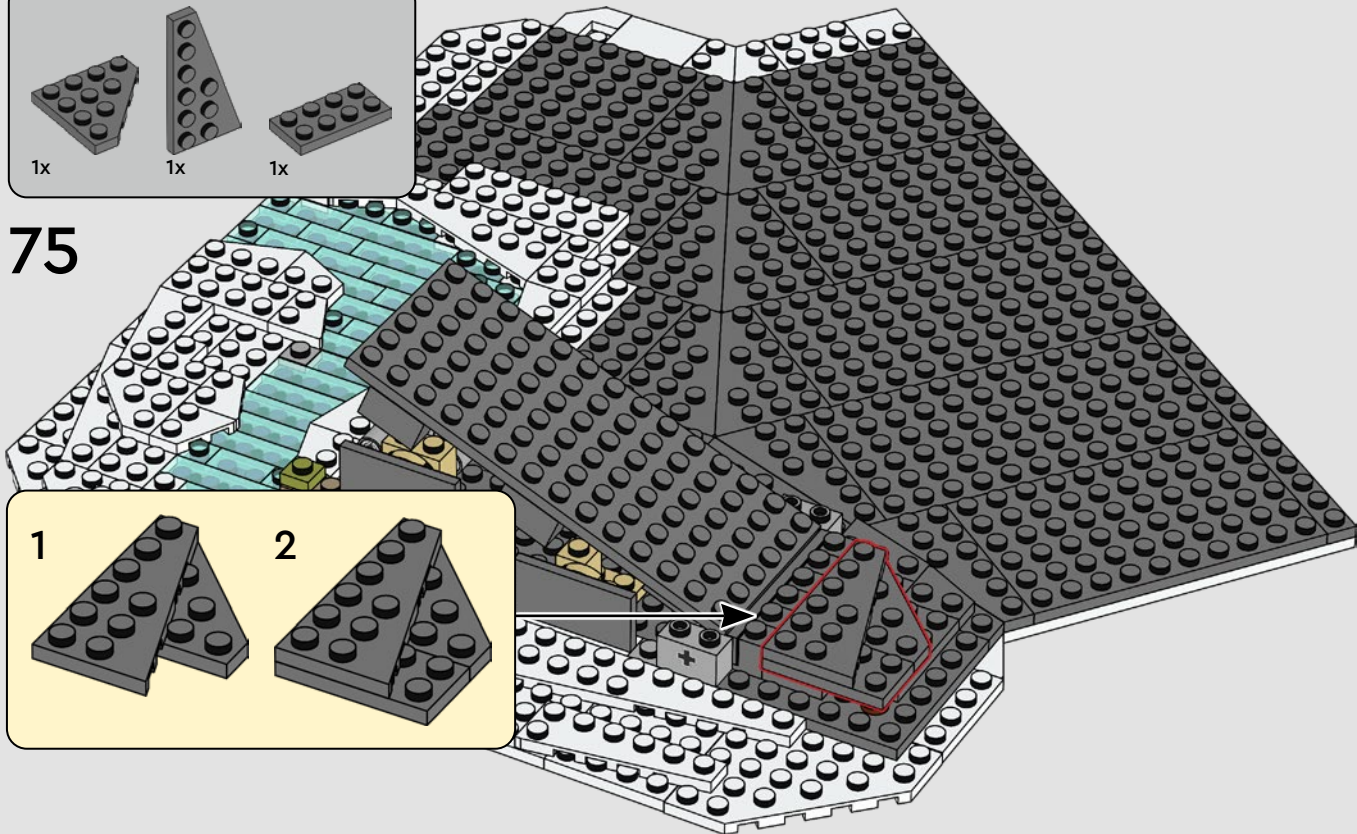
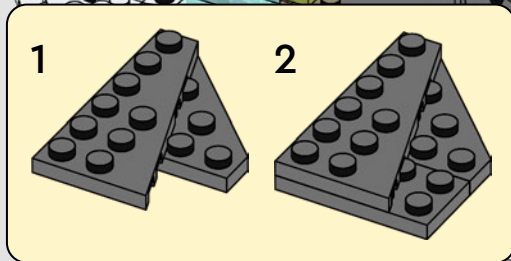

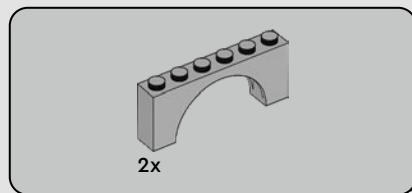

76

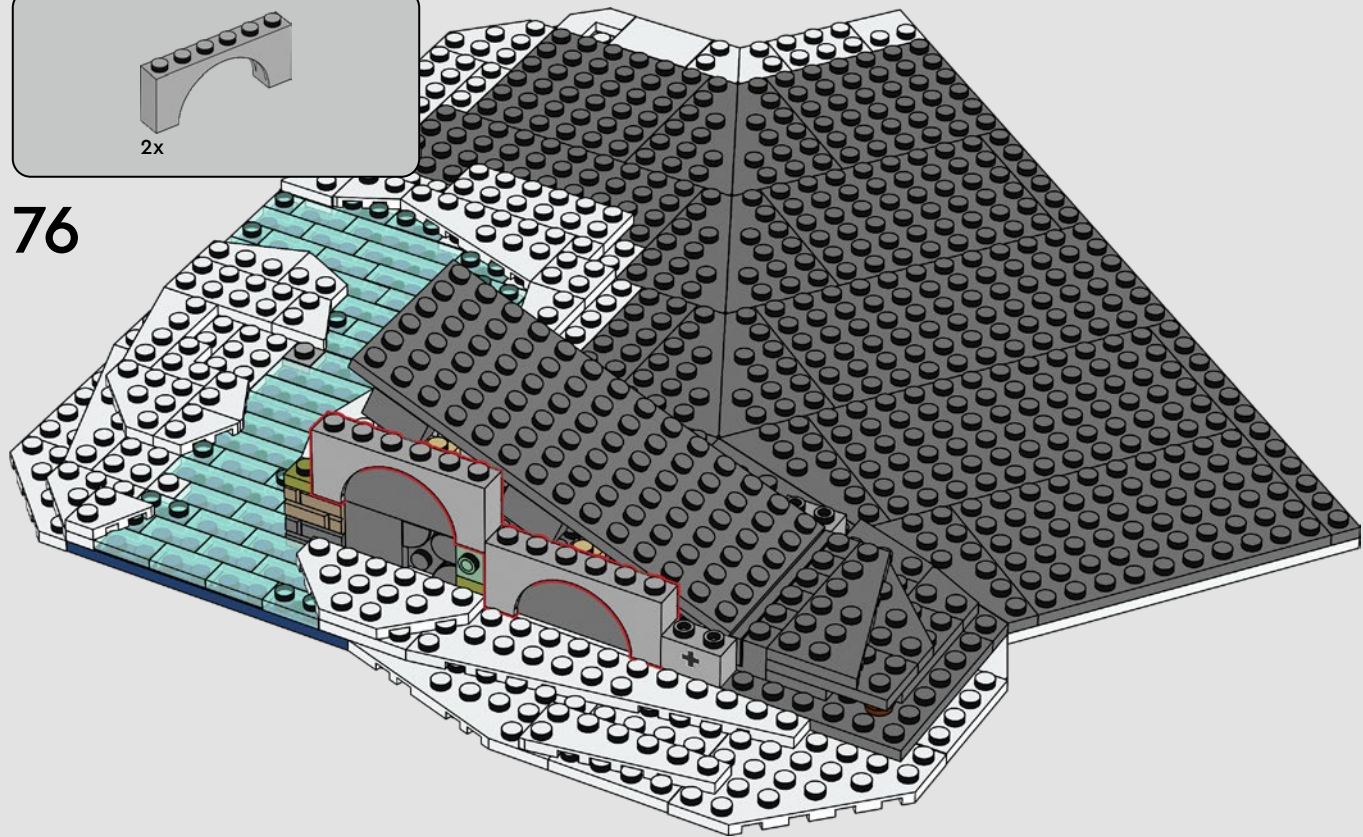

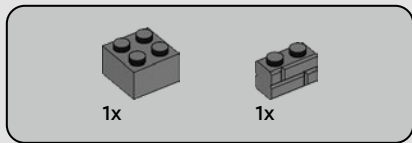

77

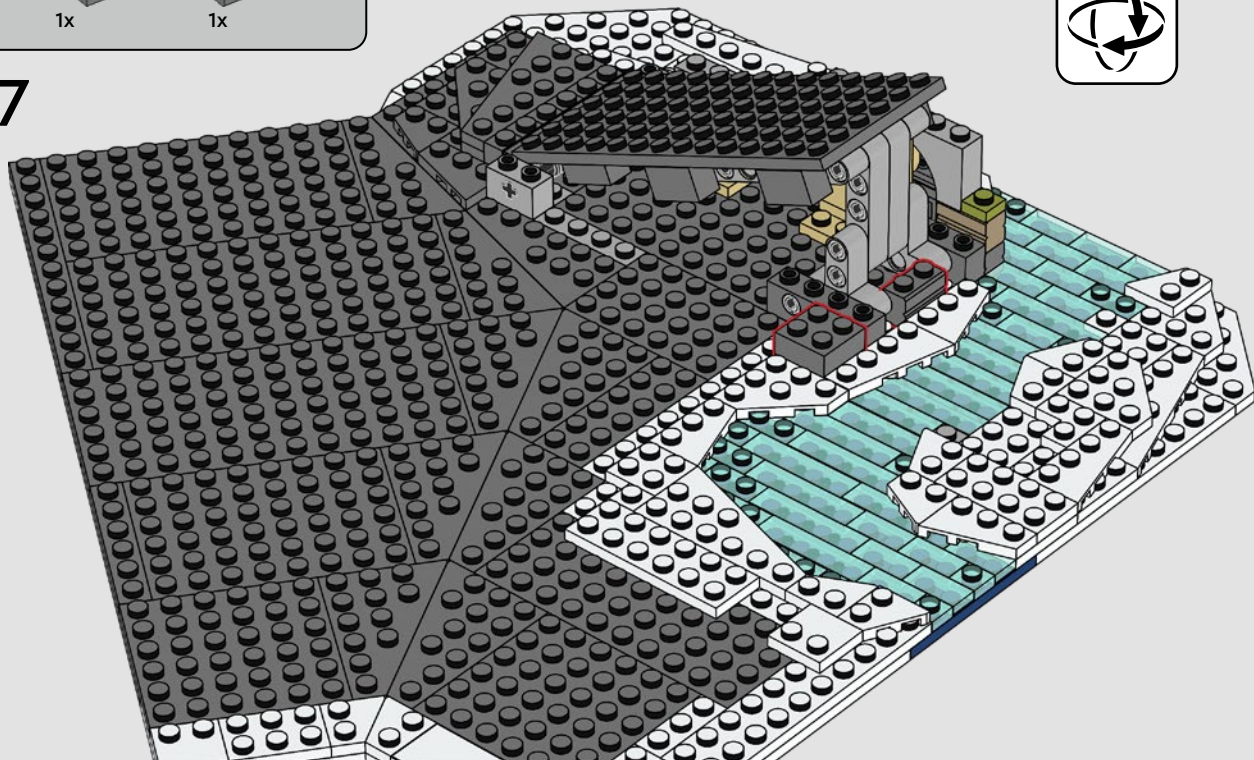

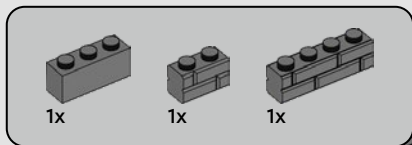

78

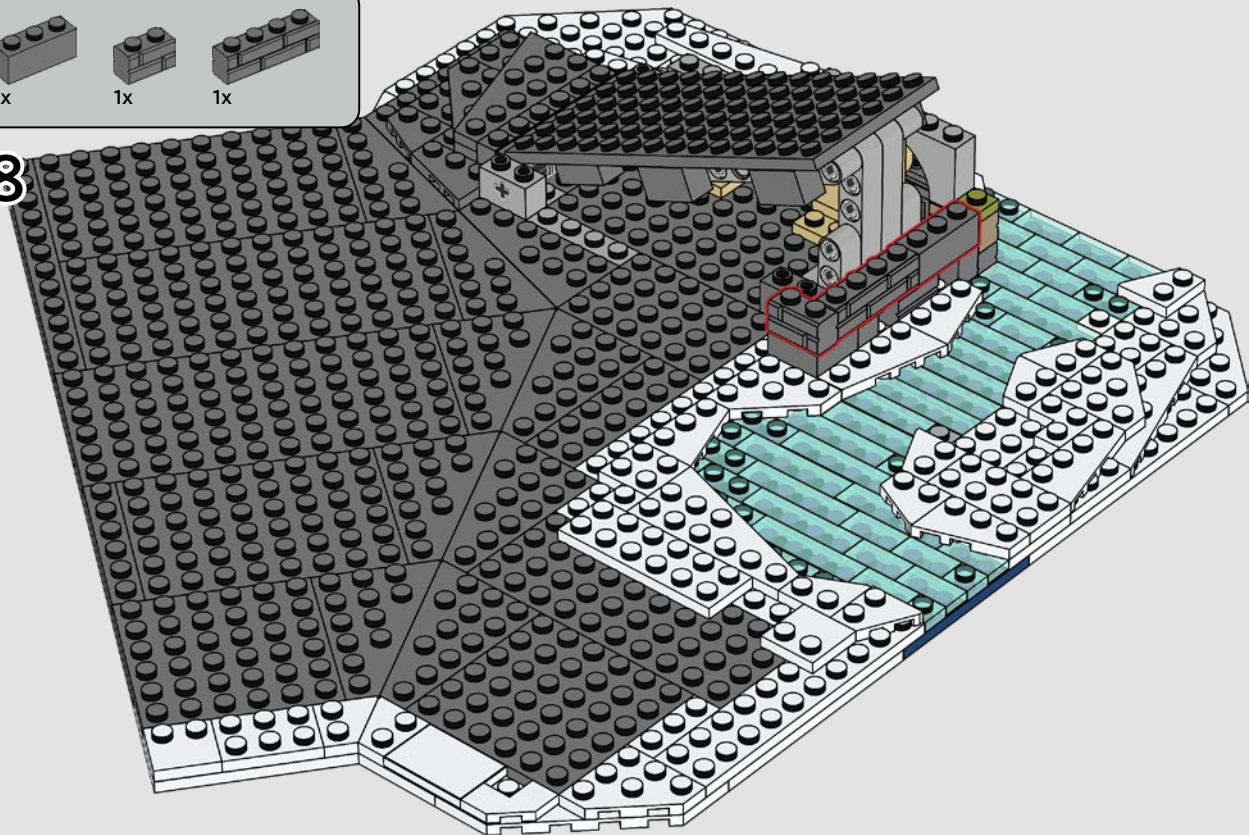

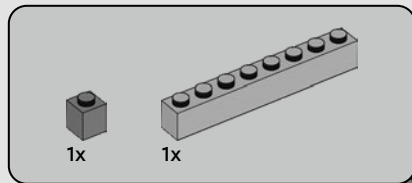

79

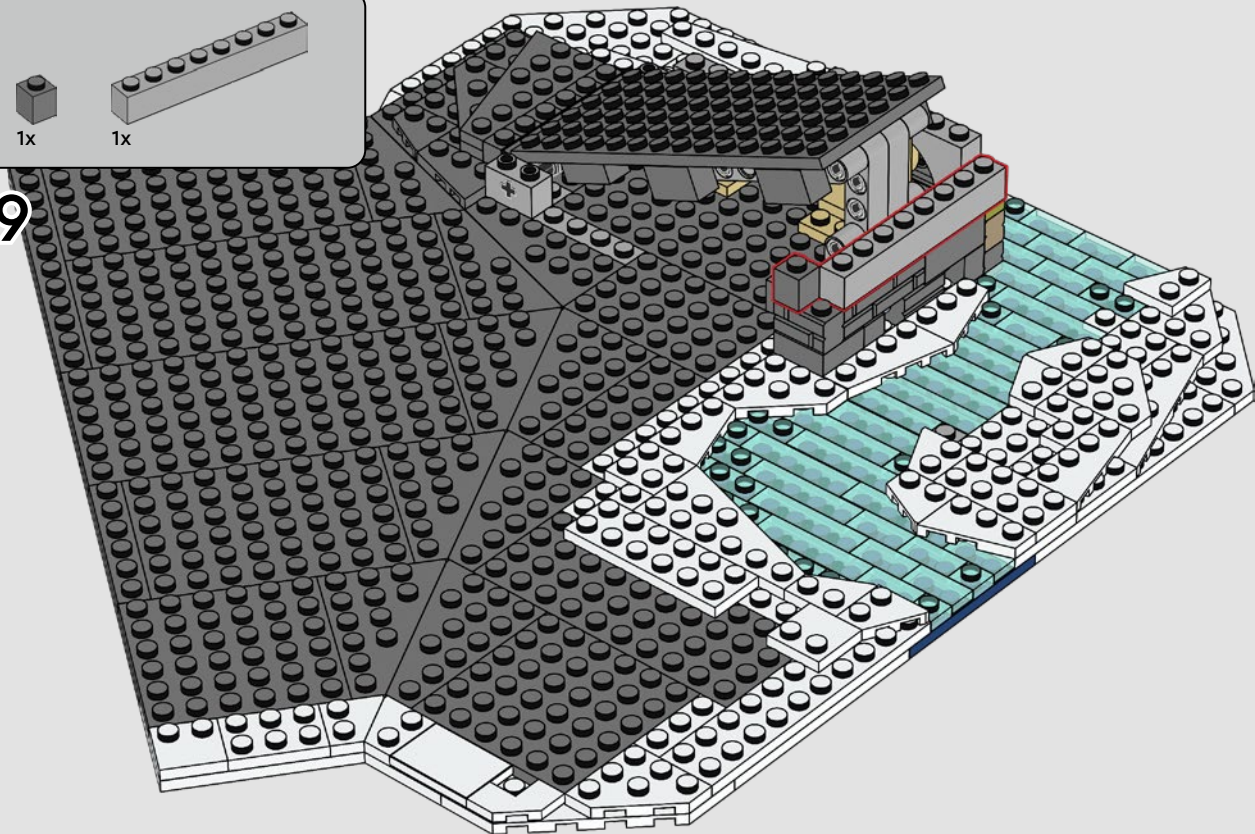

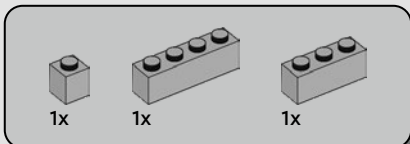

80

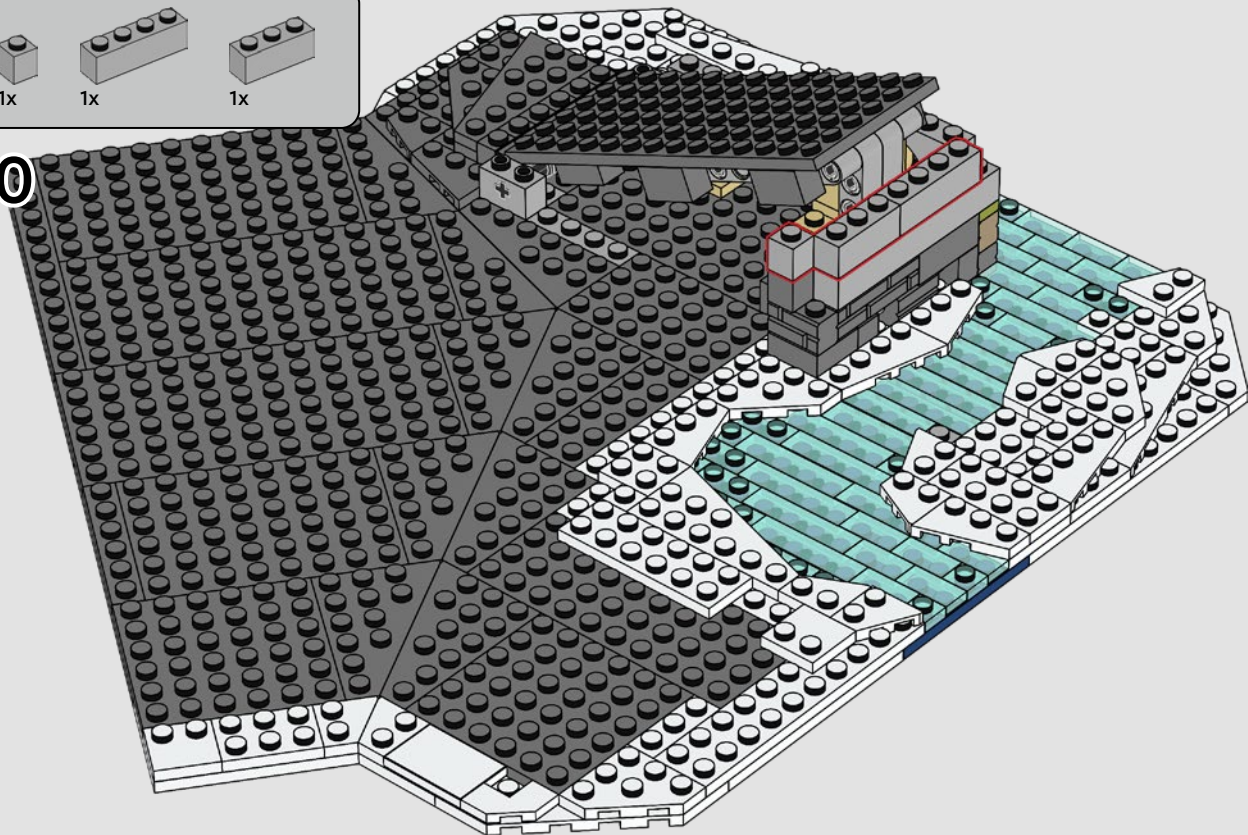



2x

81

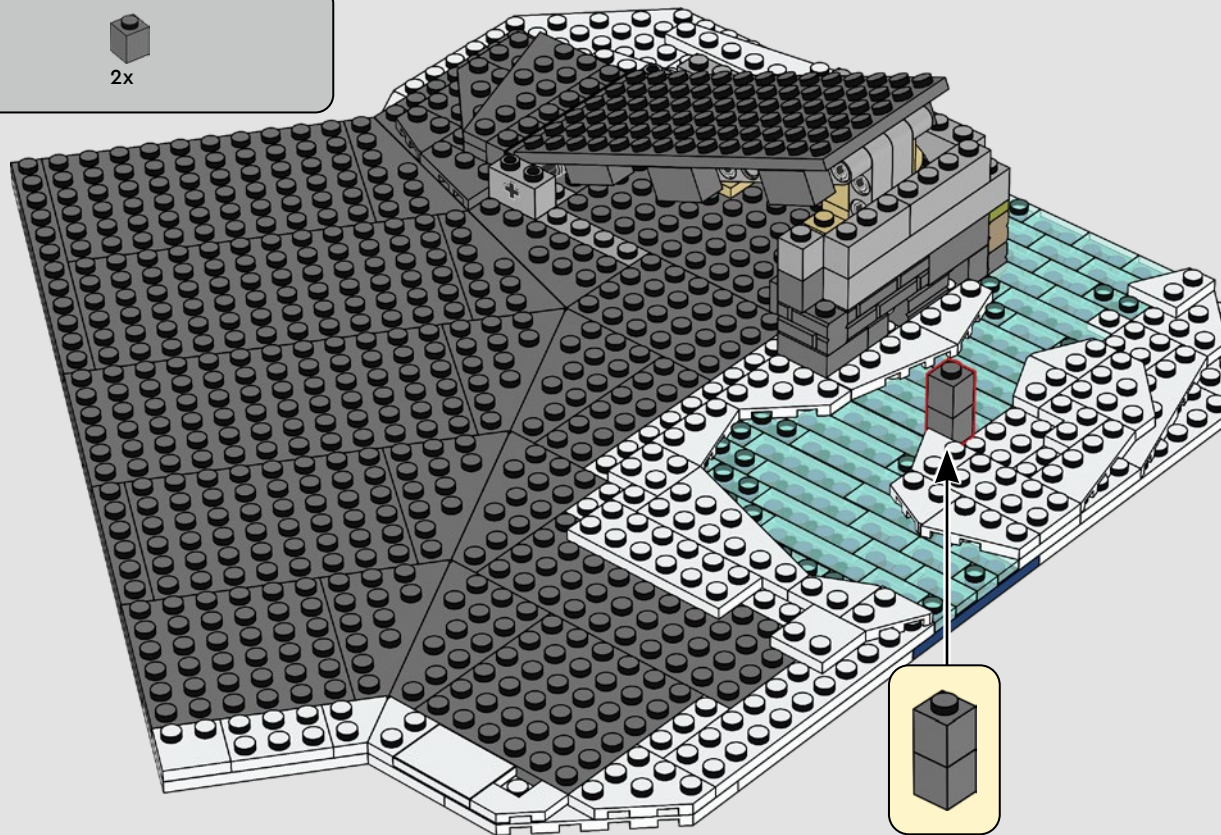

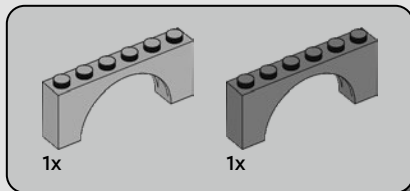

83

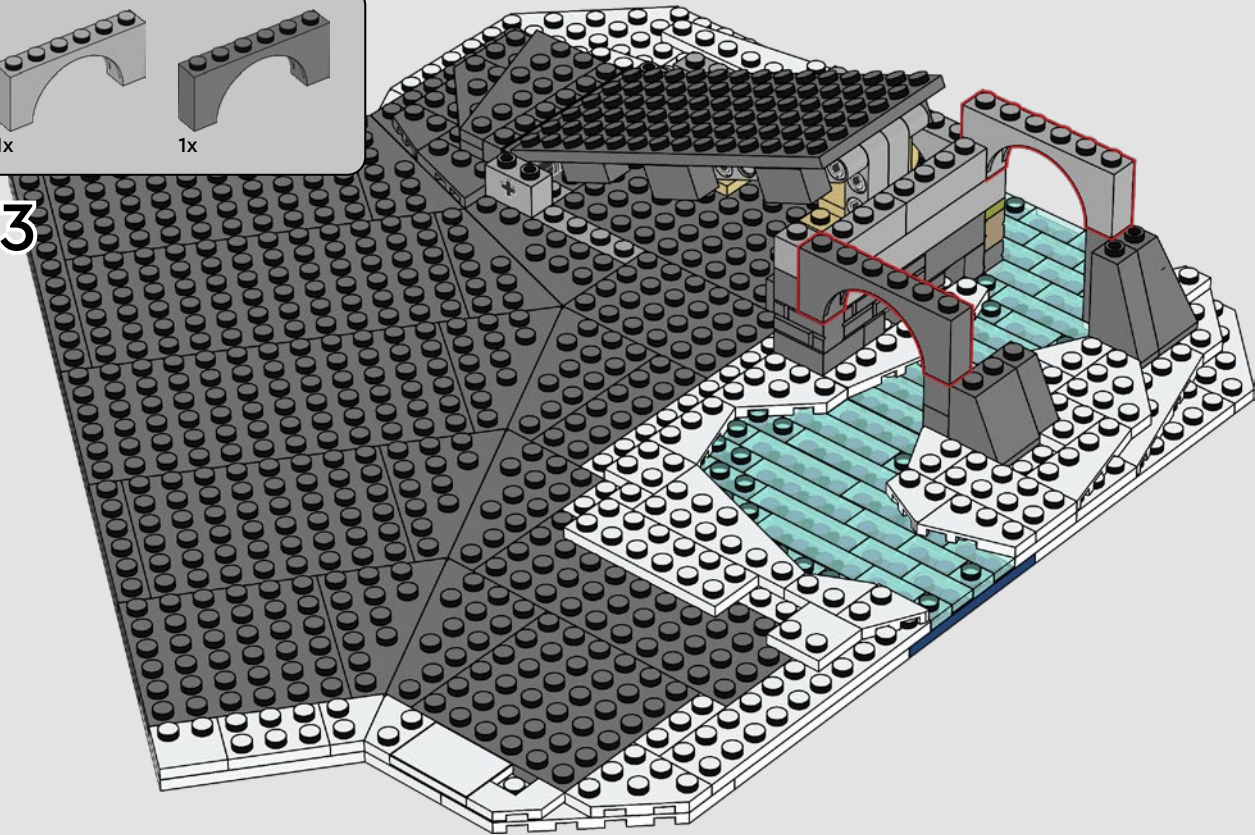



1x



1x

84

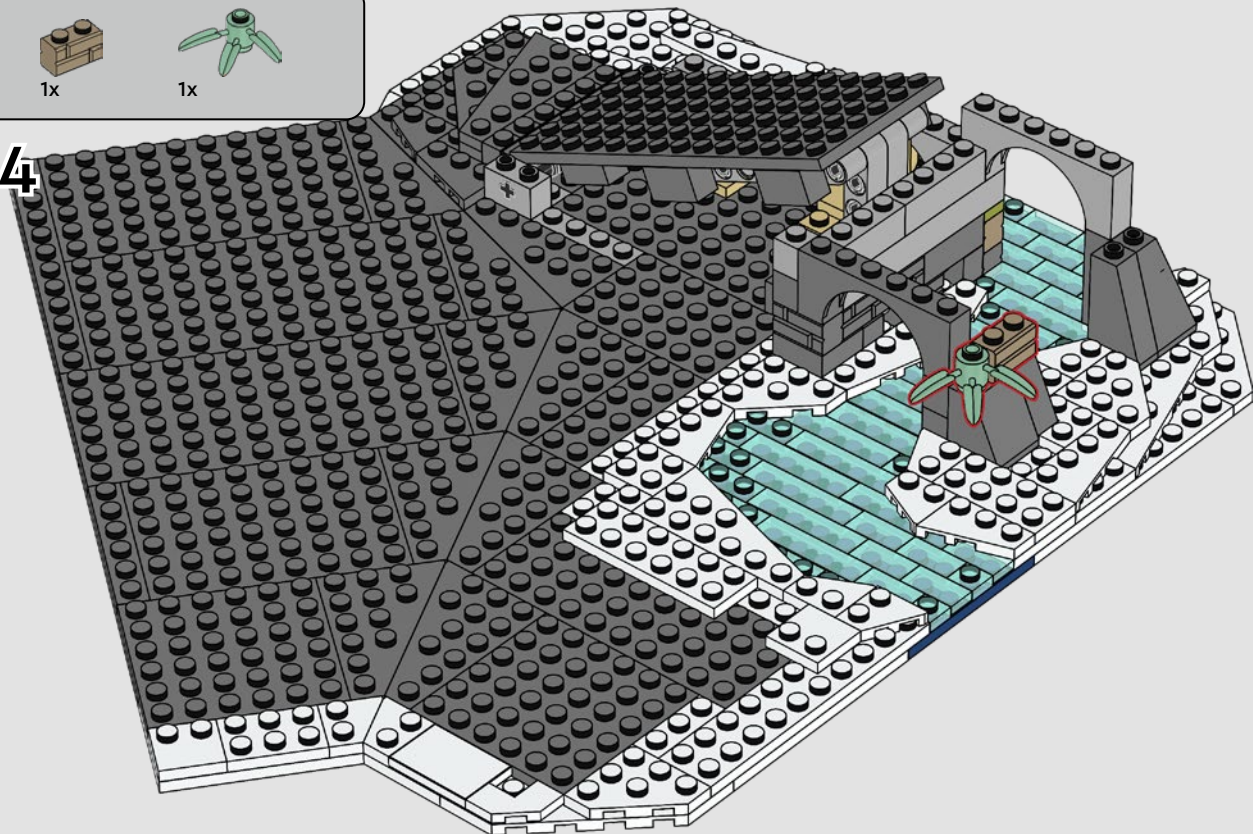

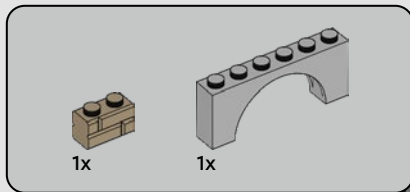

85

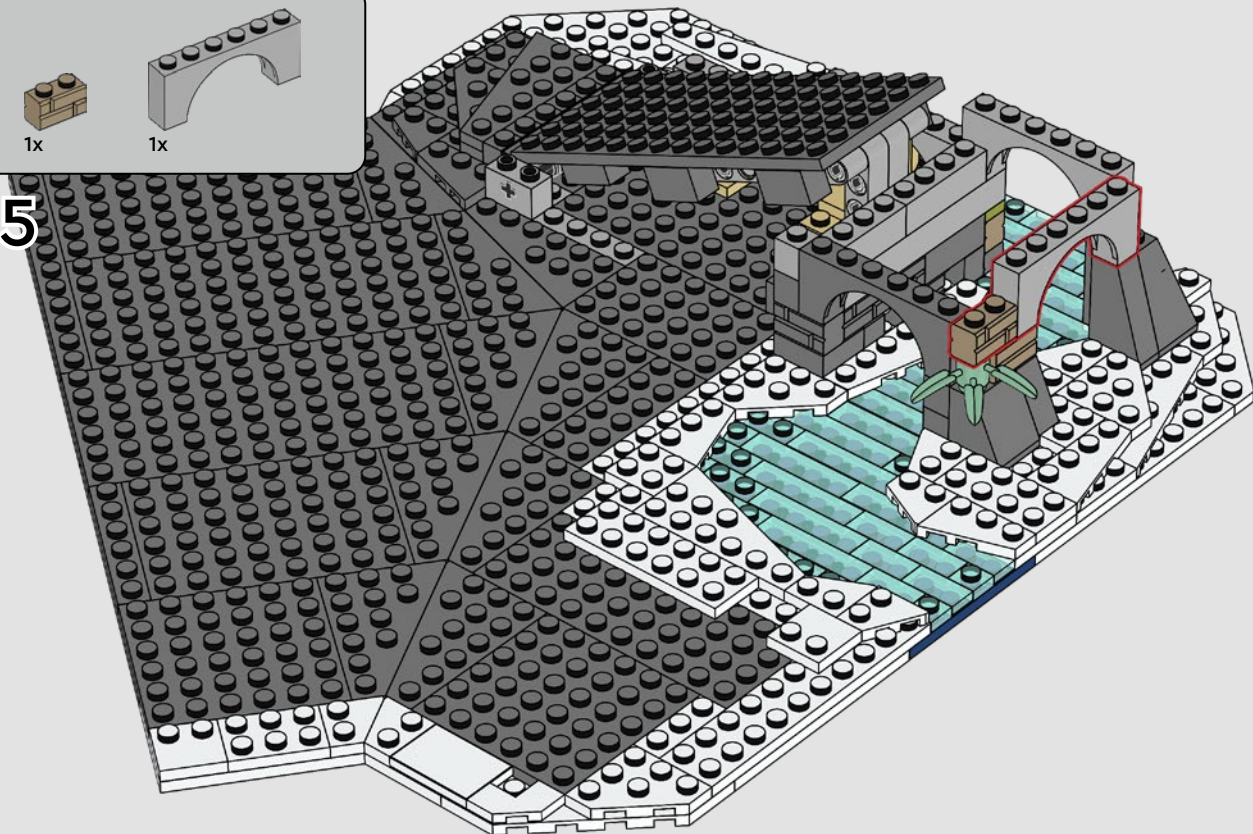

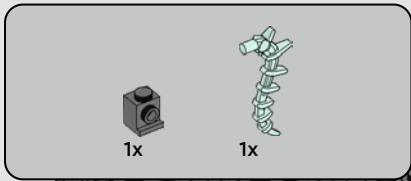

86

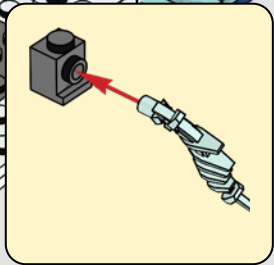
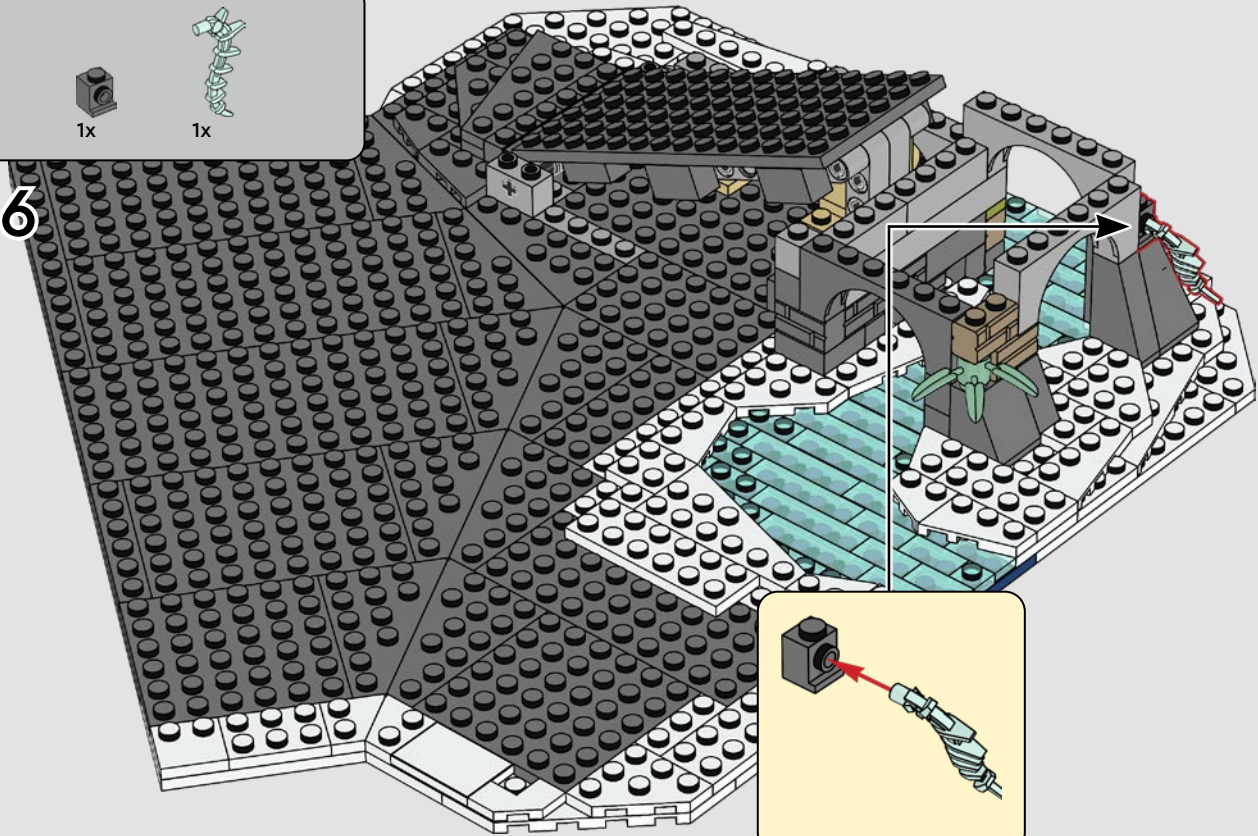



1x



1x

87

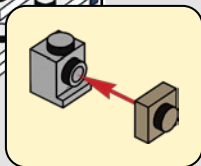
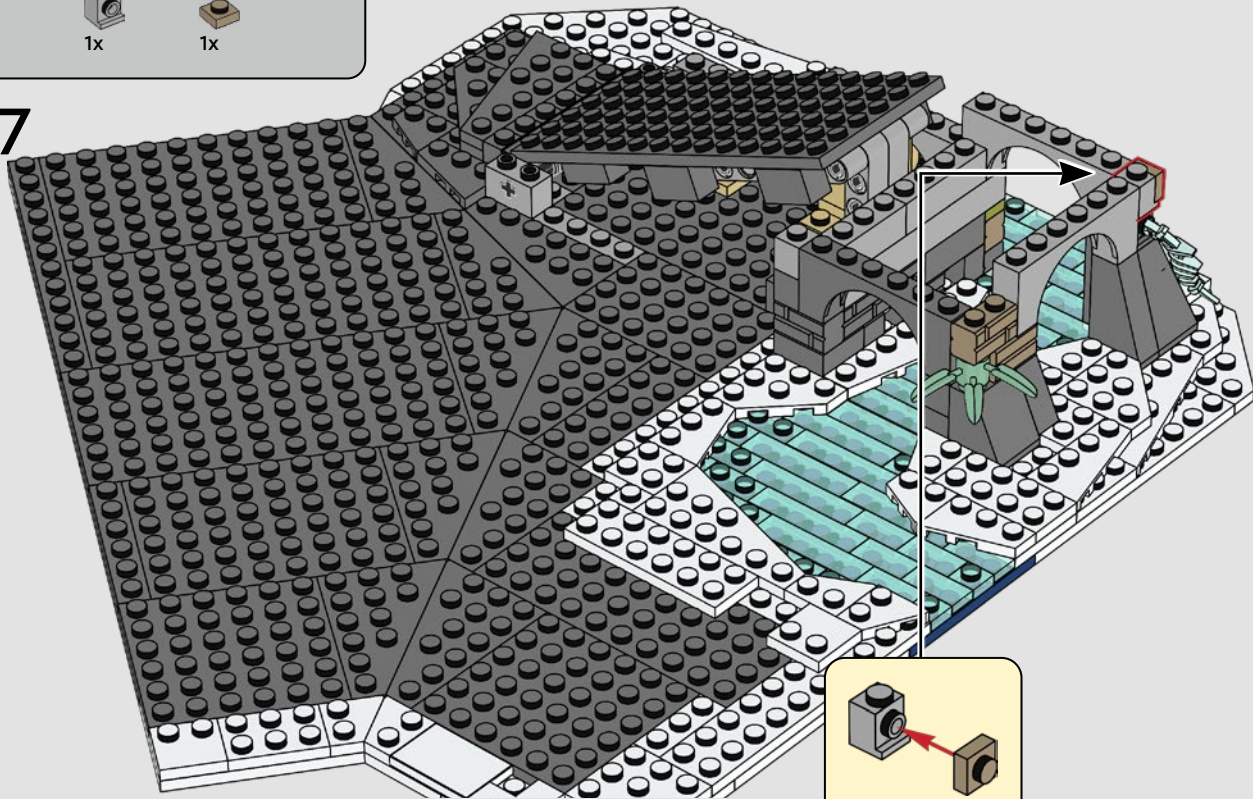

84

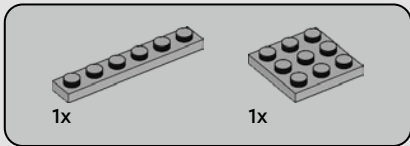
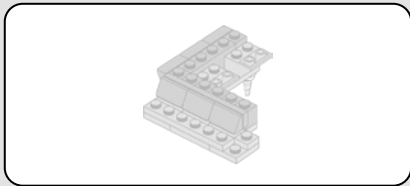

88

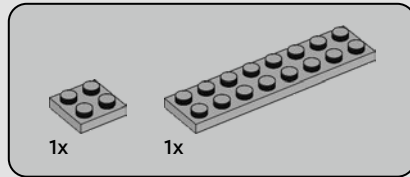
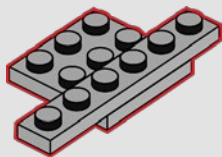

89

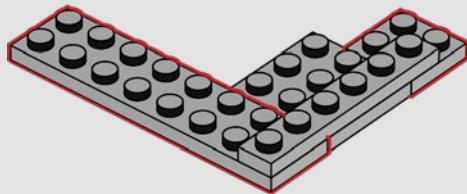



2x

90

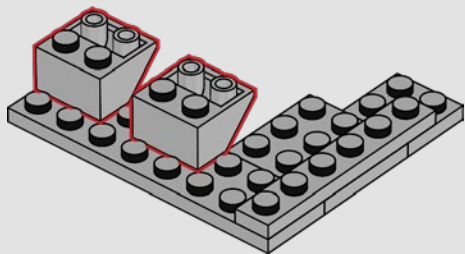

1x



3x



1x

91

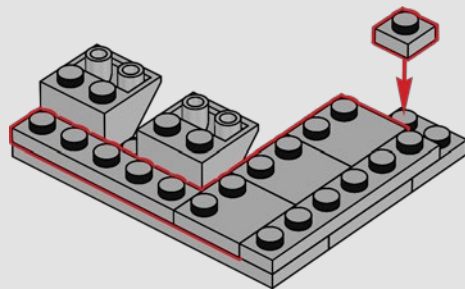

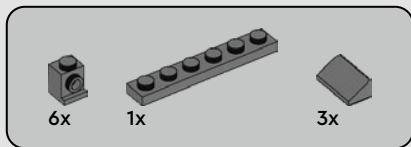

92

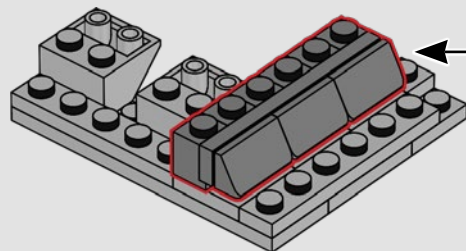
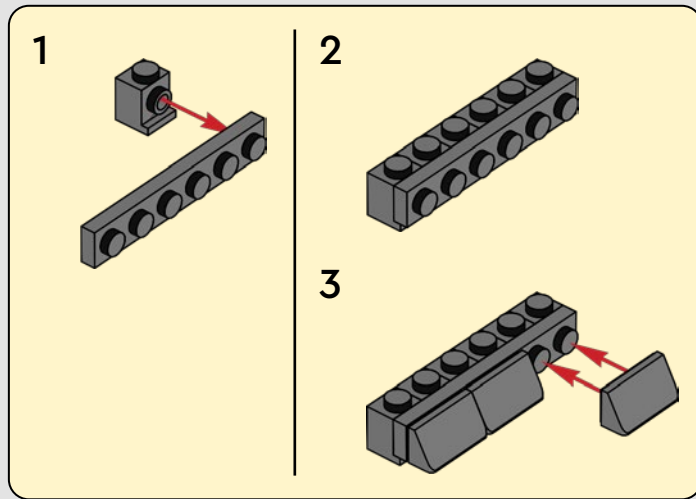

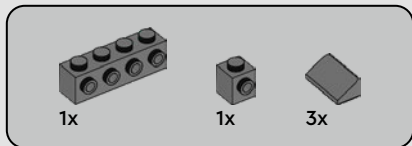

93

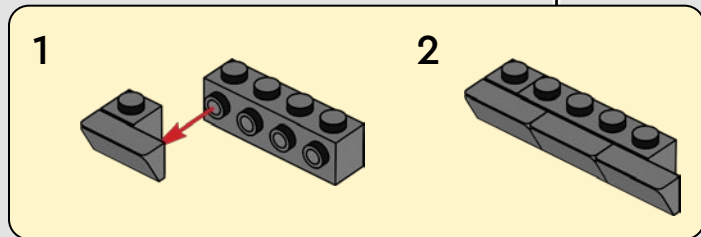
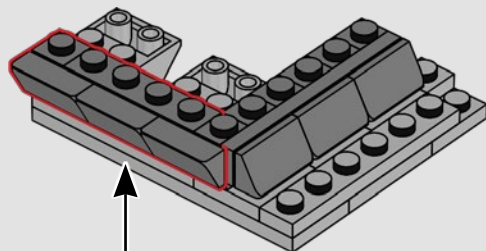

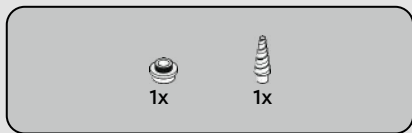

94

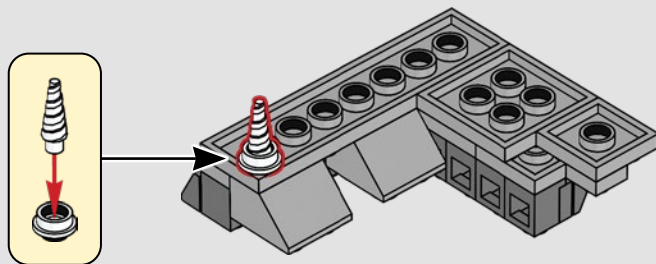

95

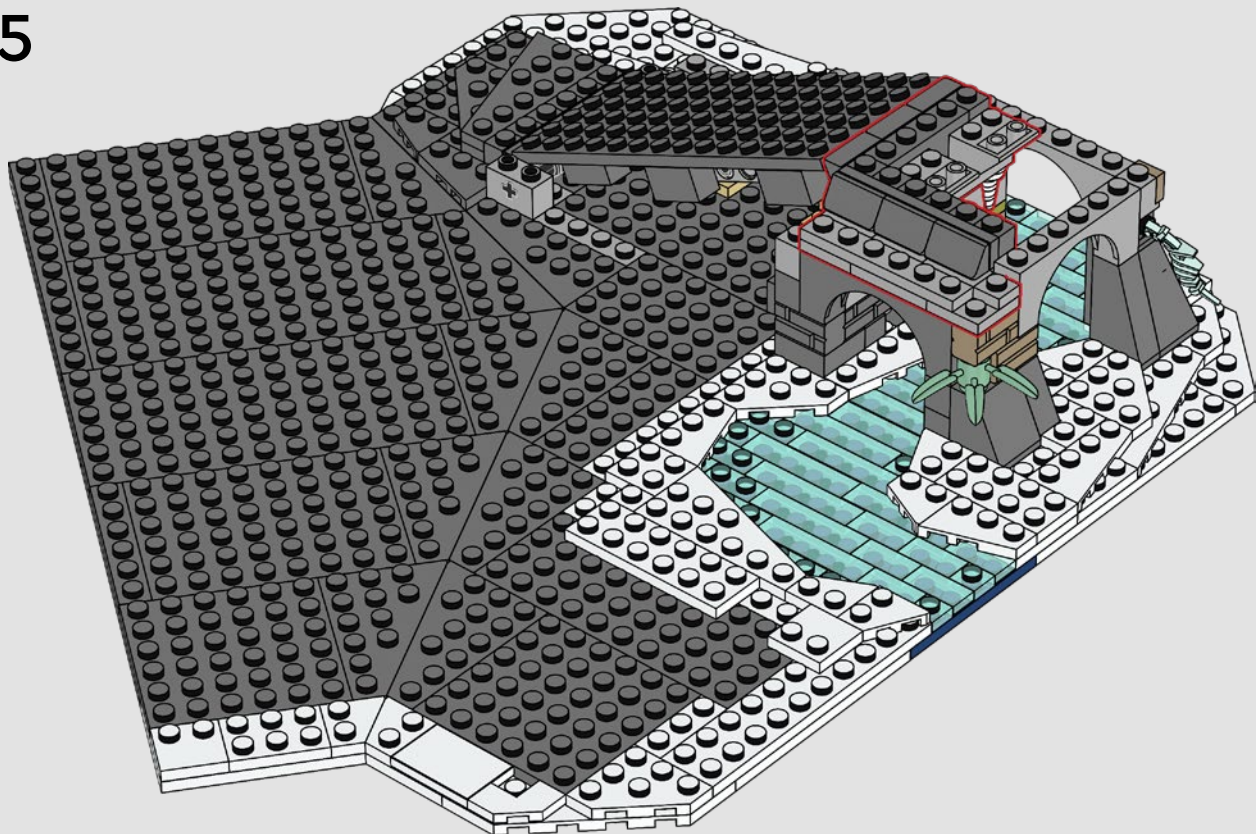

90

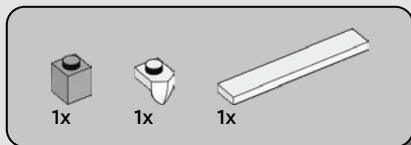

96

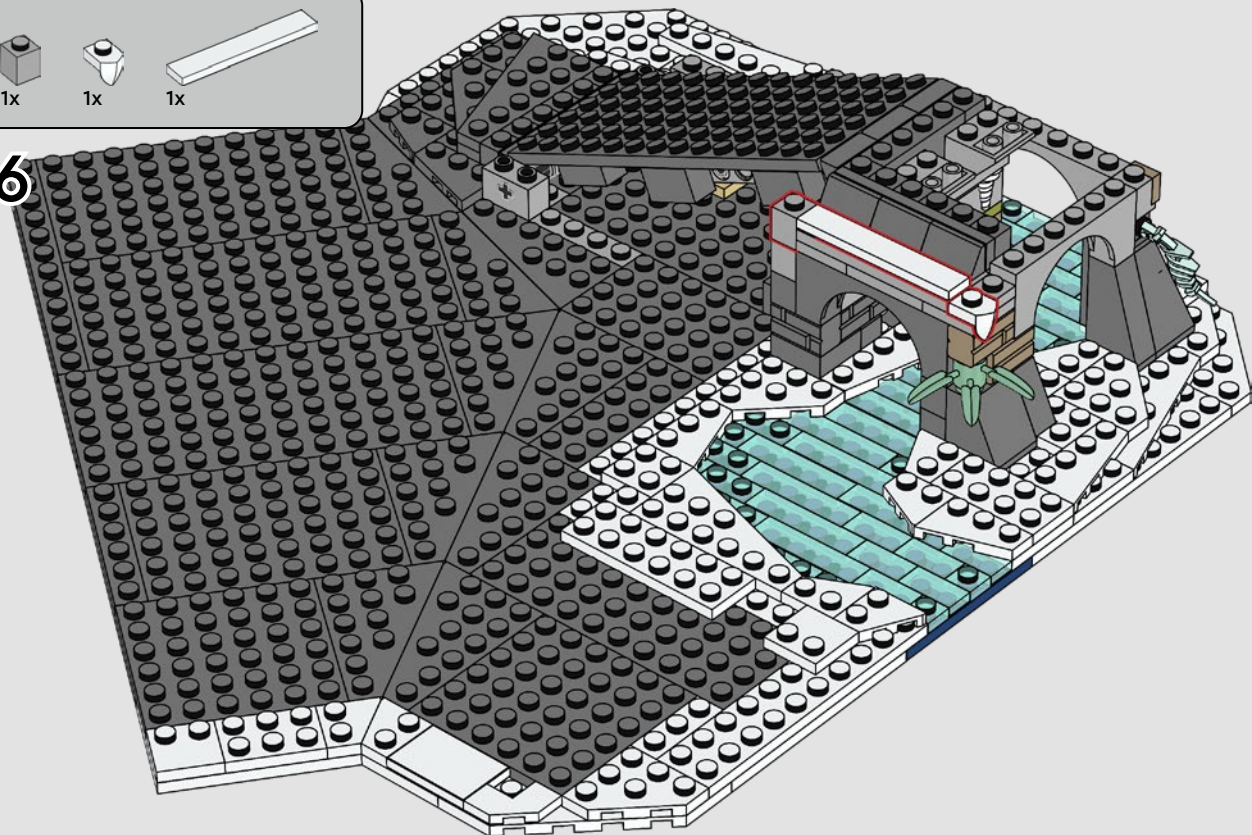

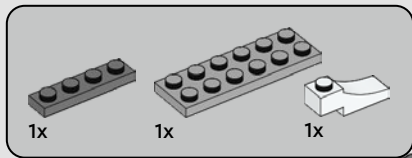

97

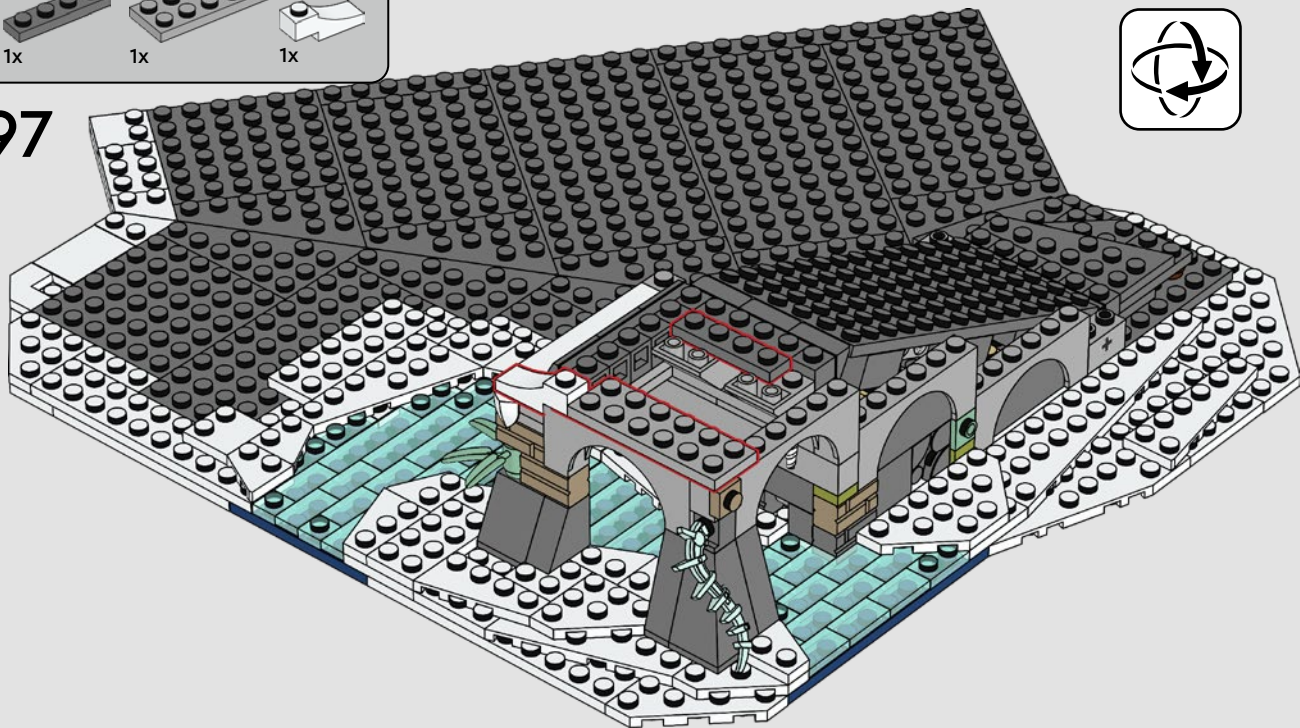

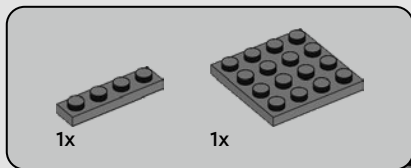

98

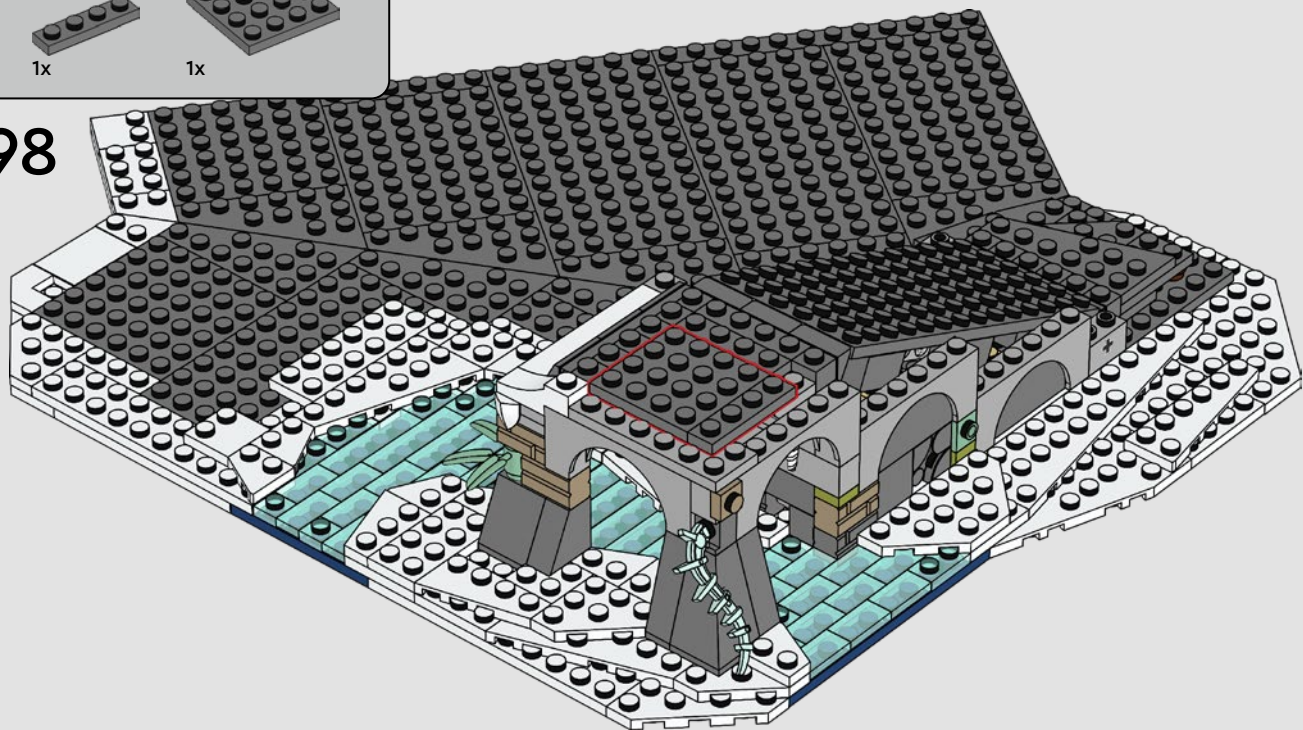

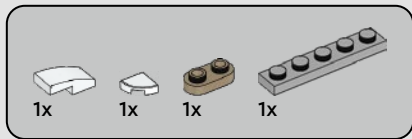

99

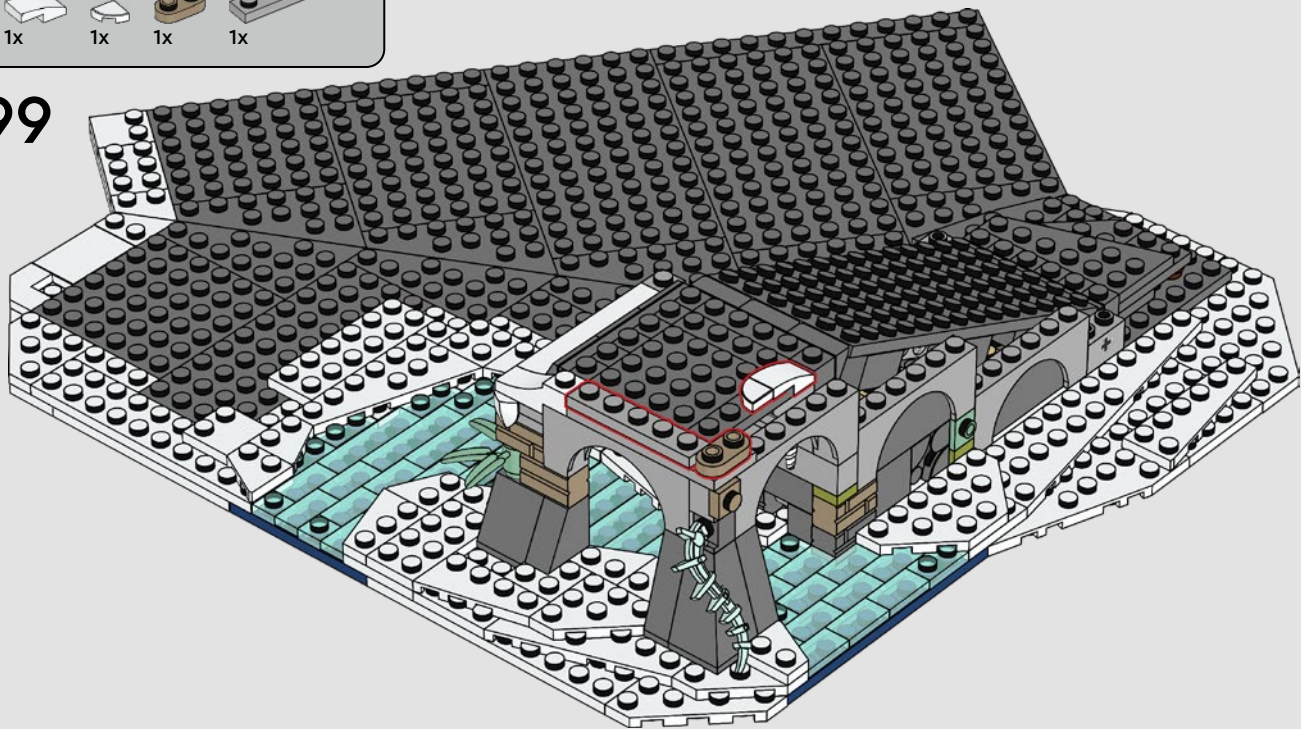

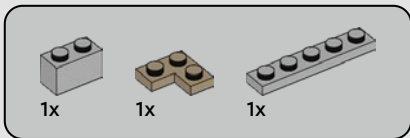

100

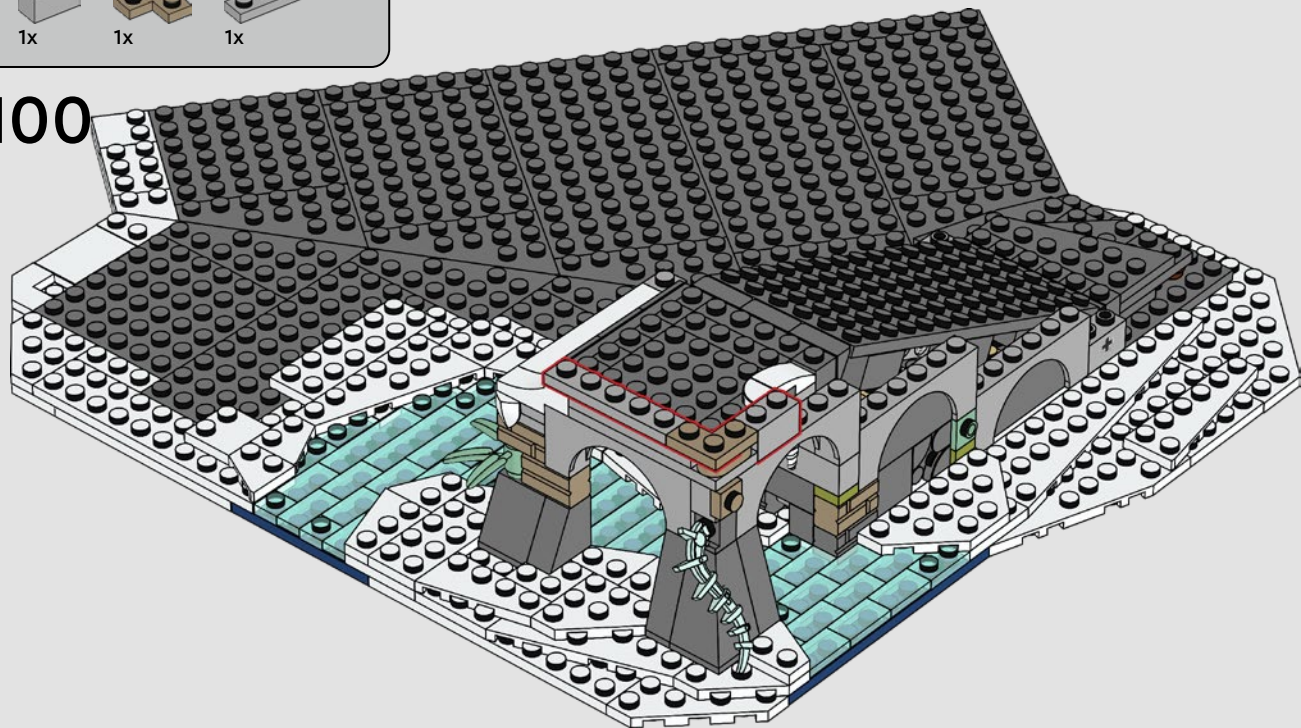

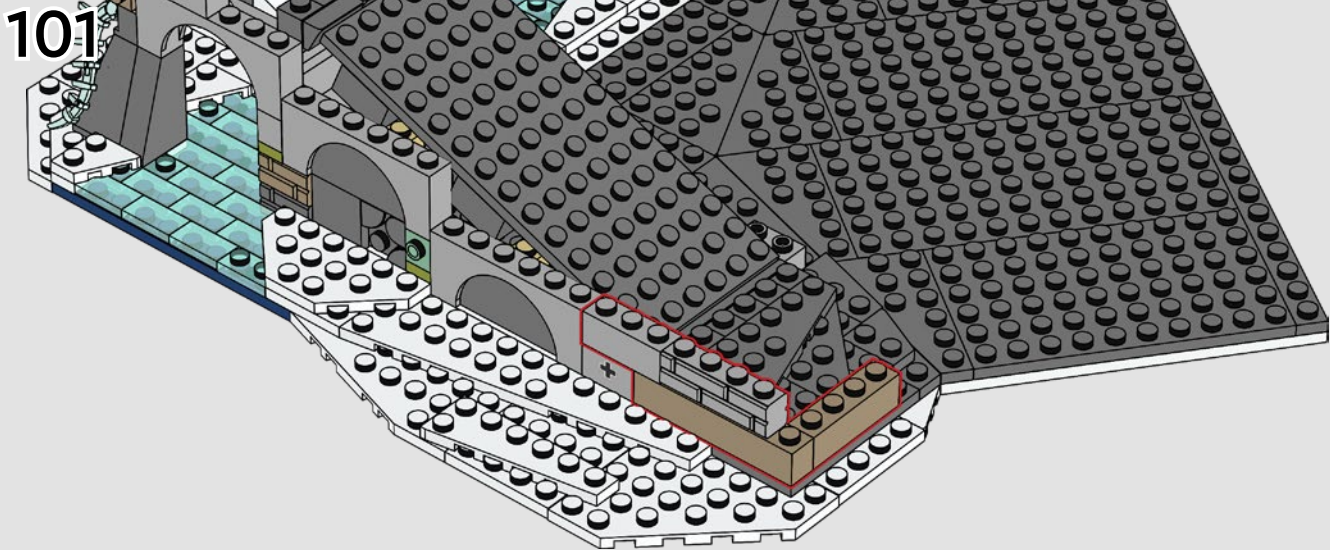
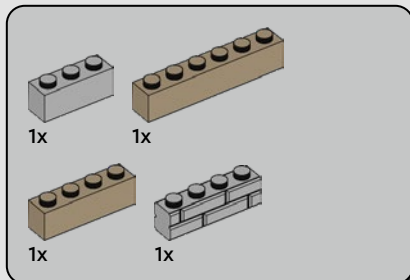

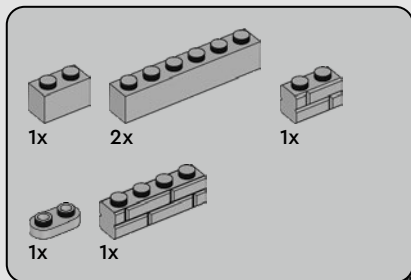

102

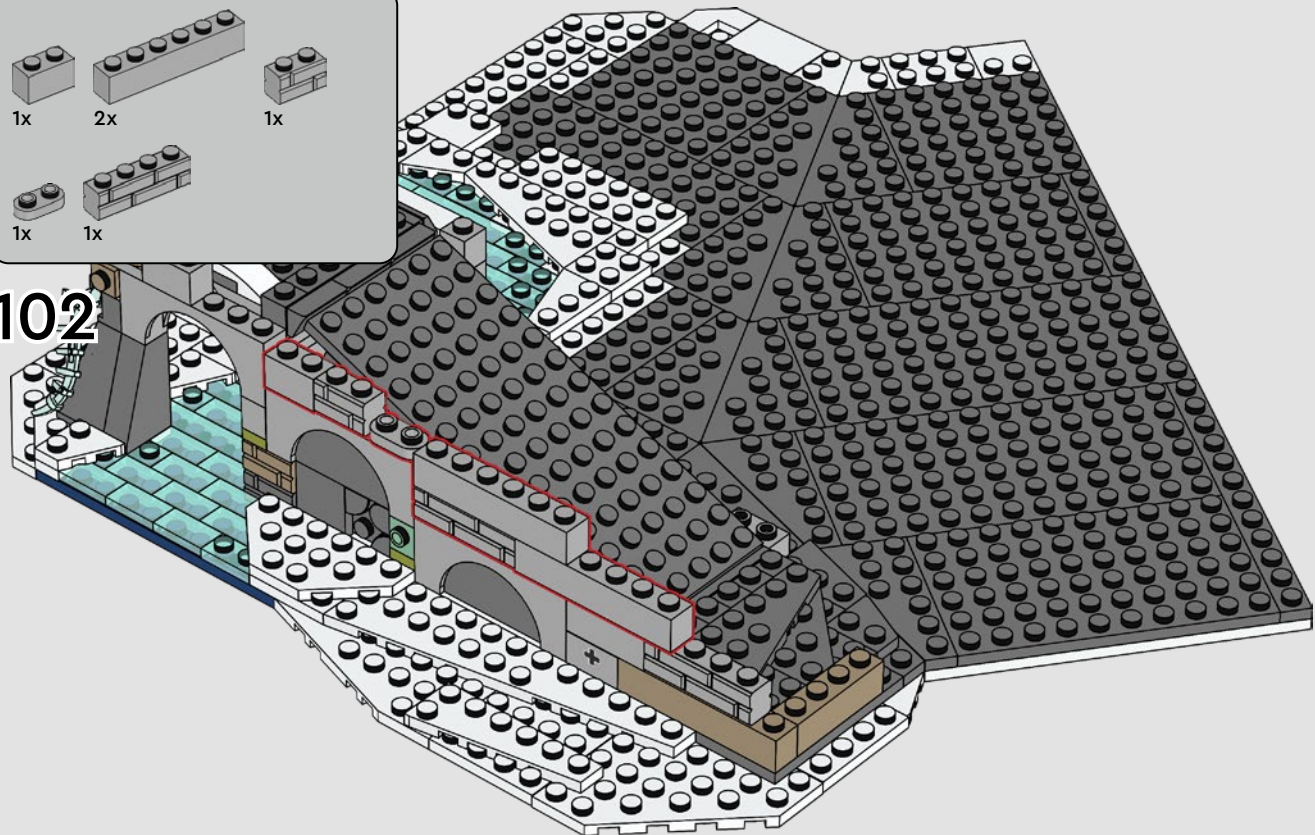

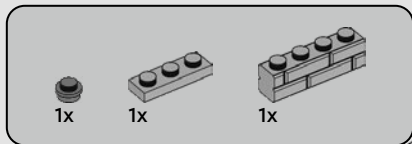

103

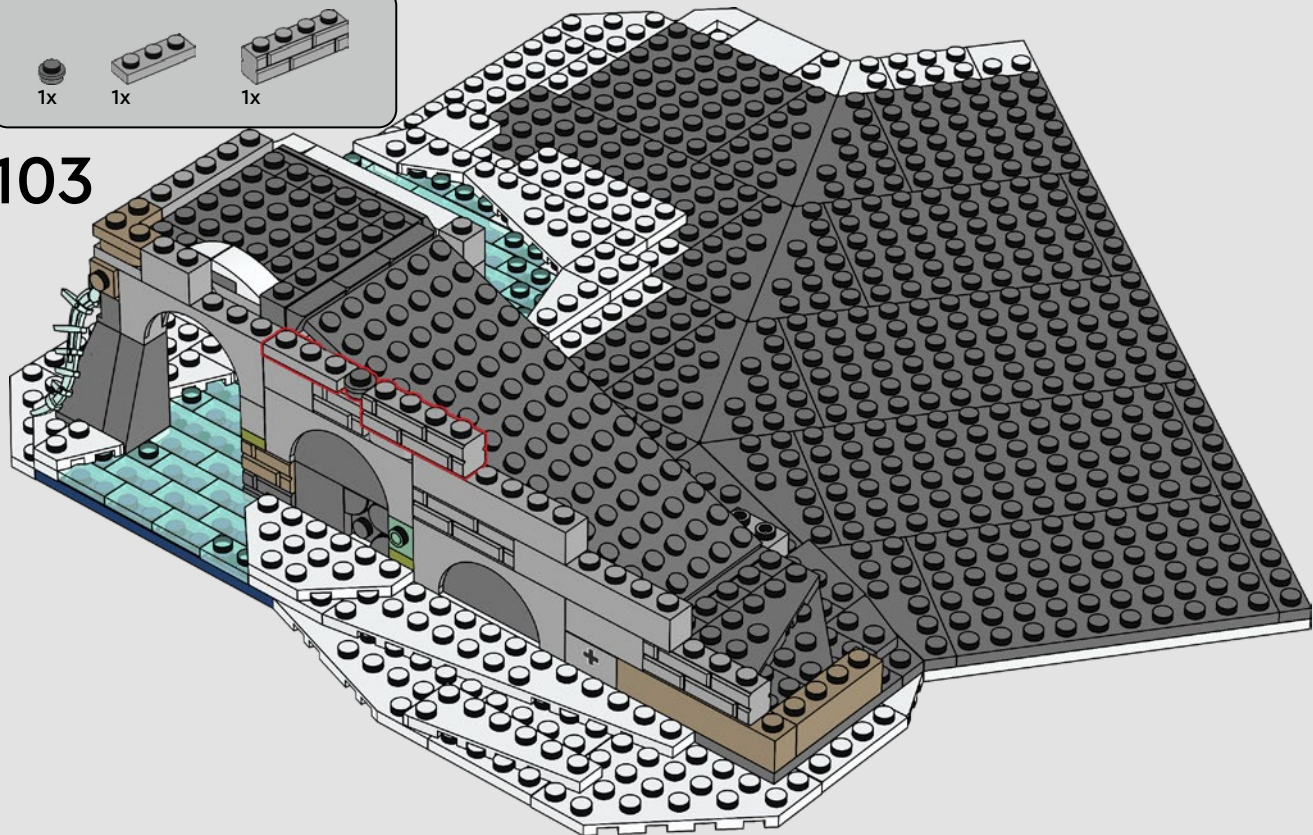

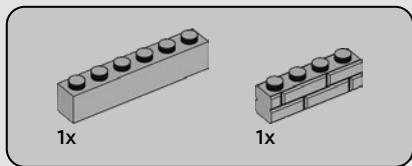

104

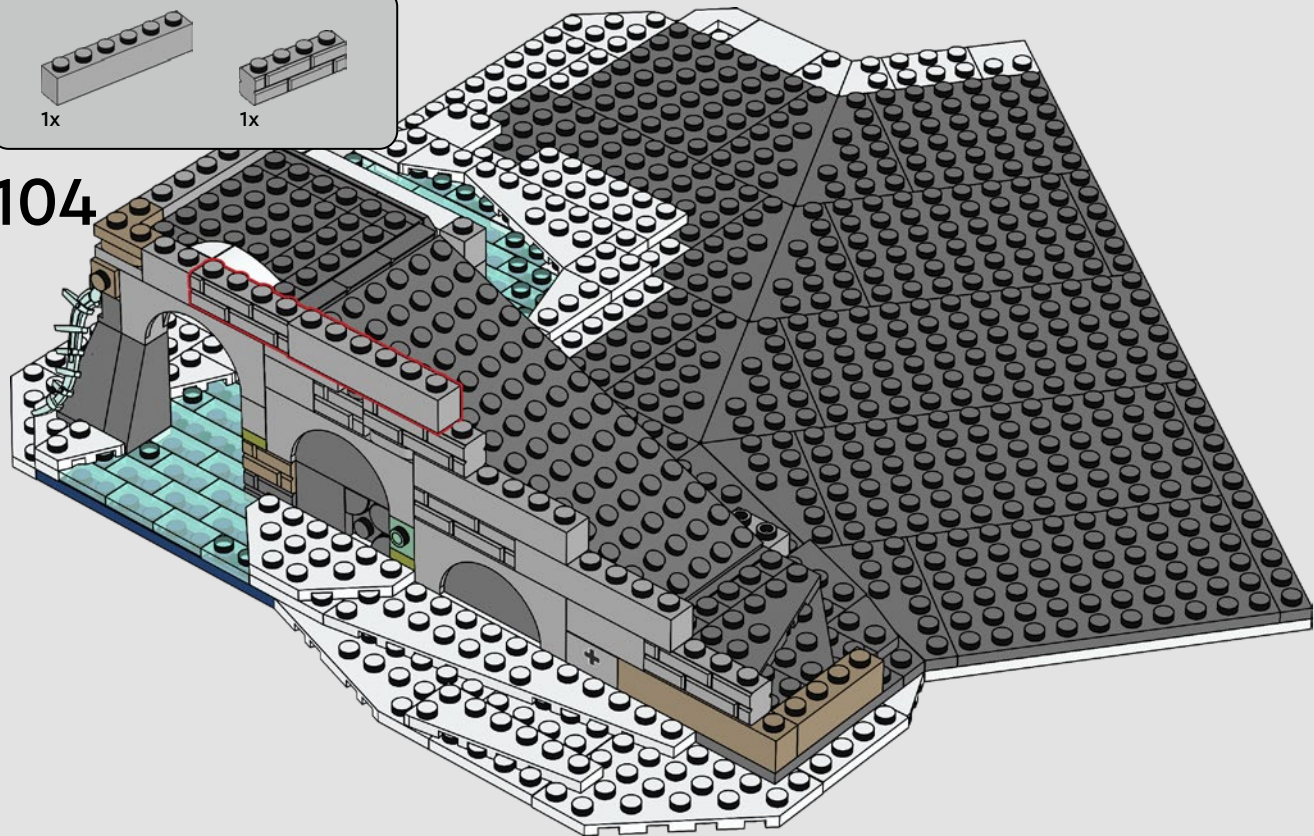

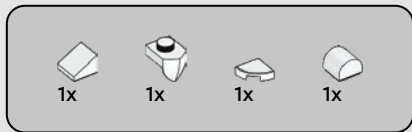

105

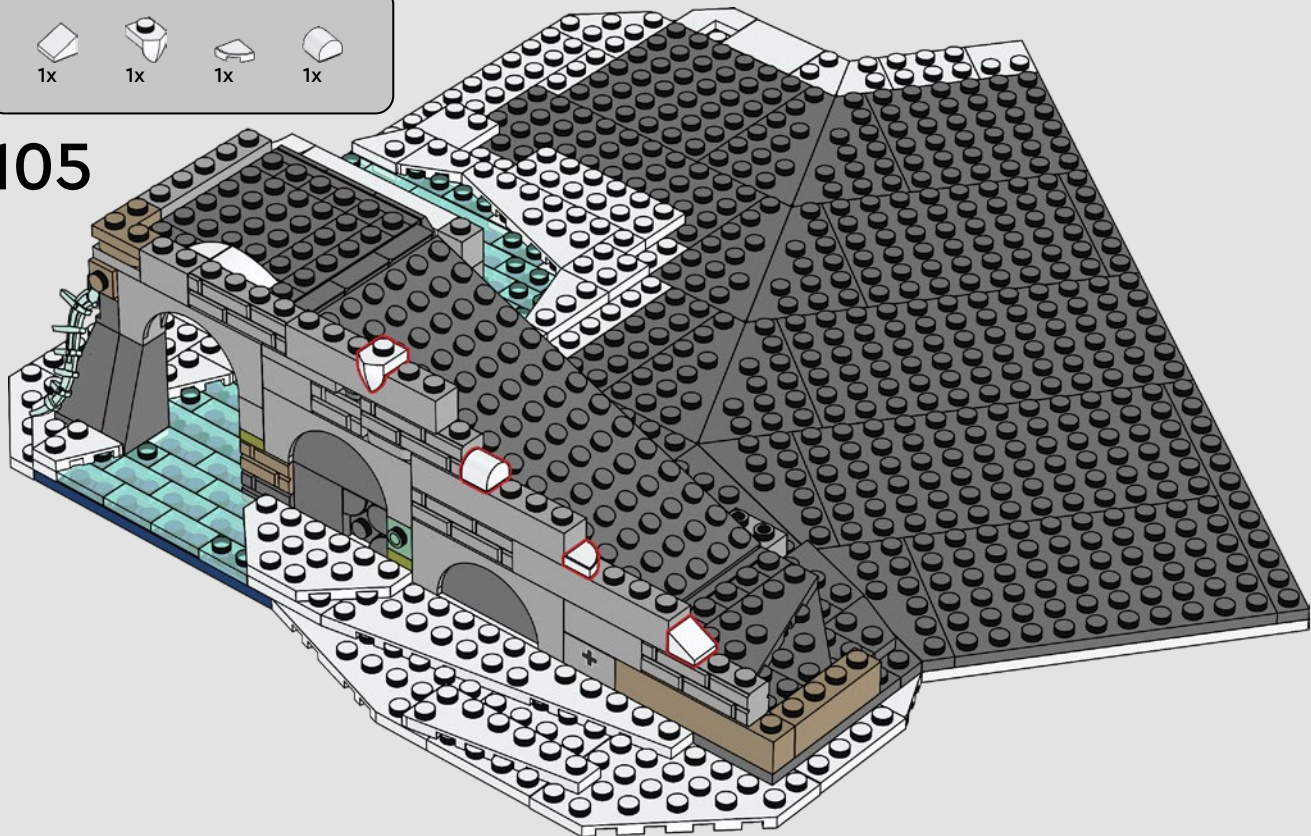



1x



1x

106

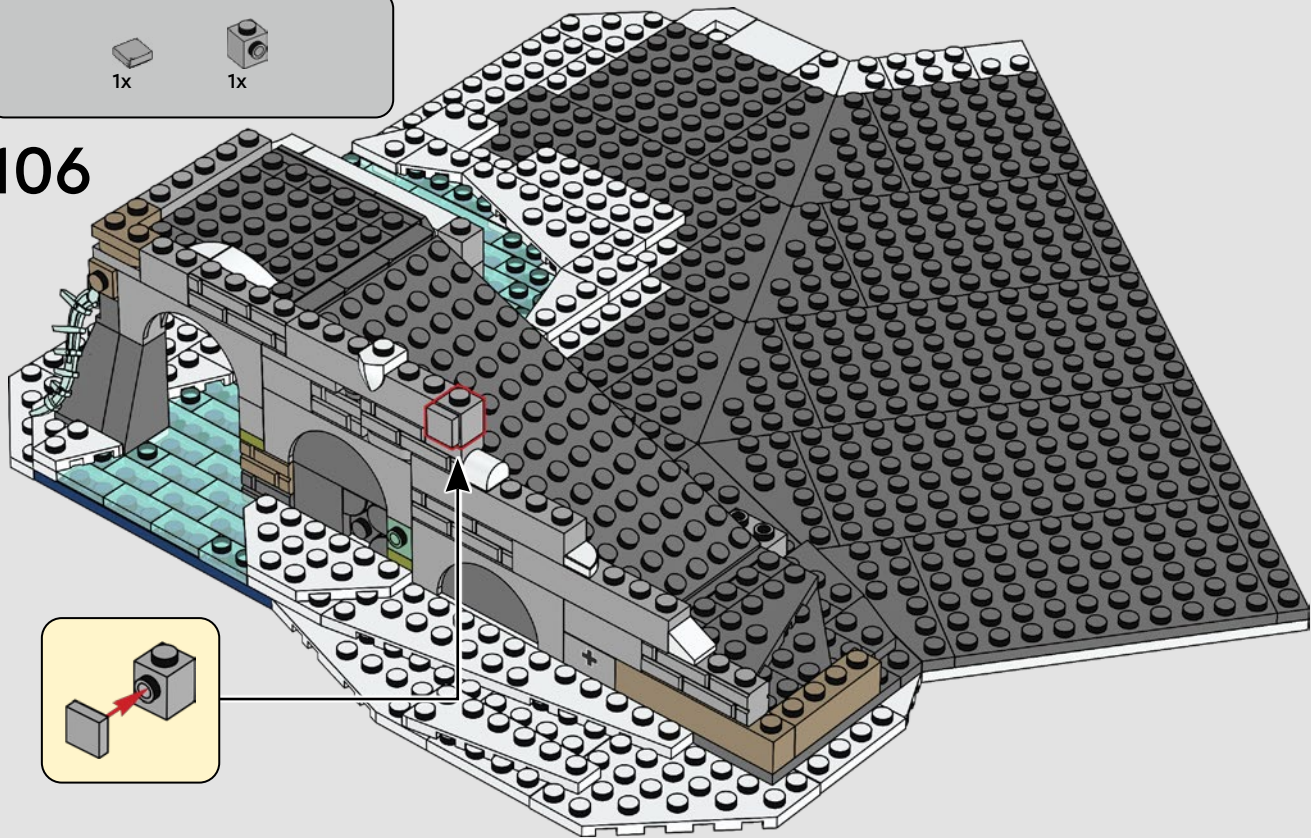

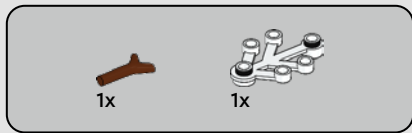

107

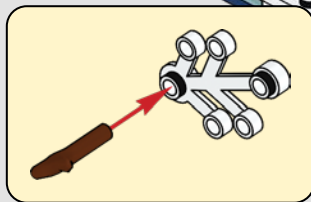
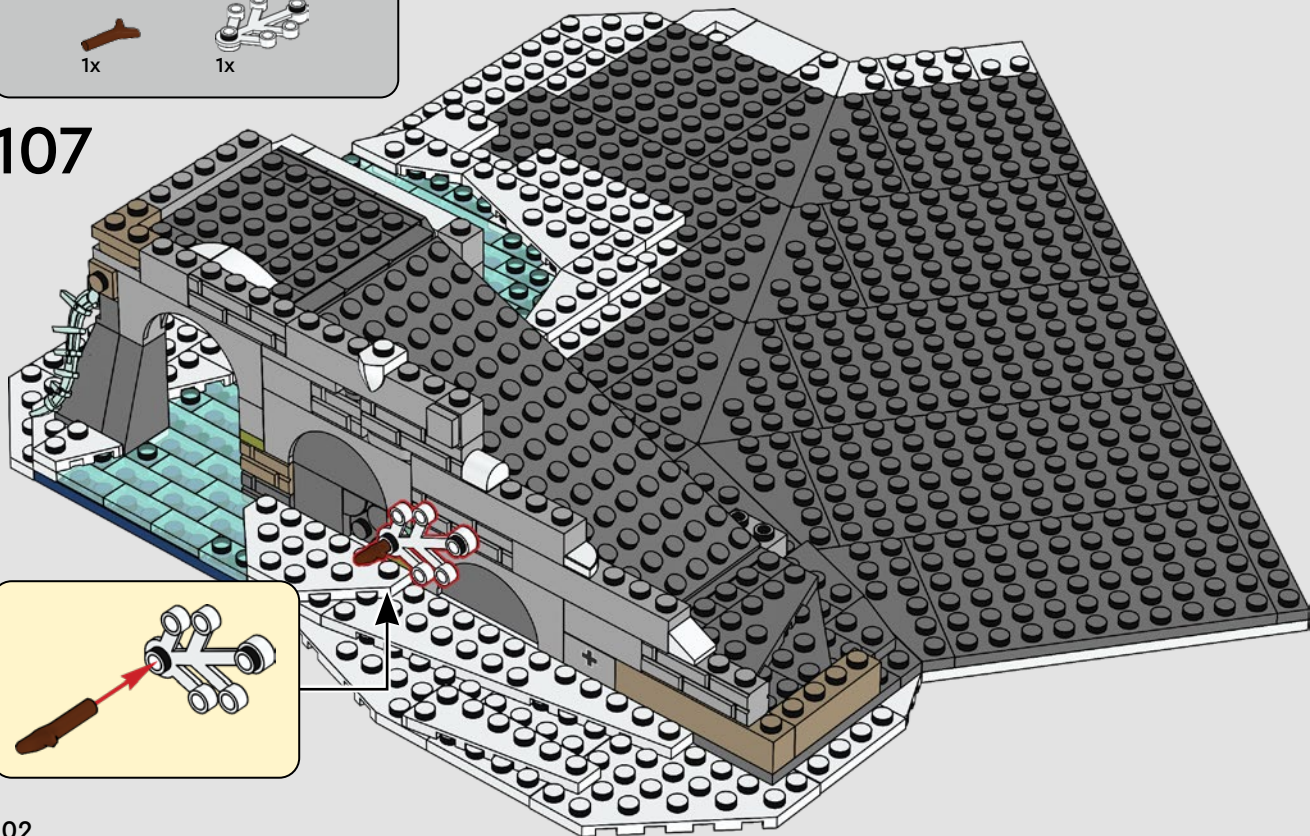

102



1x



1x

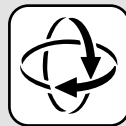

108

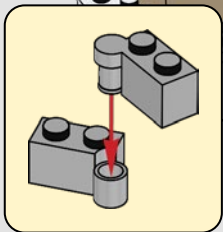
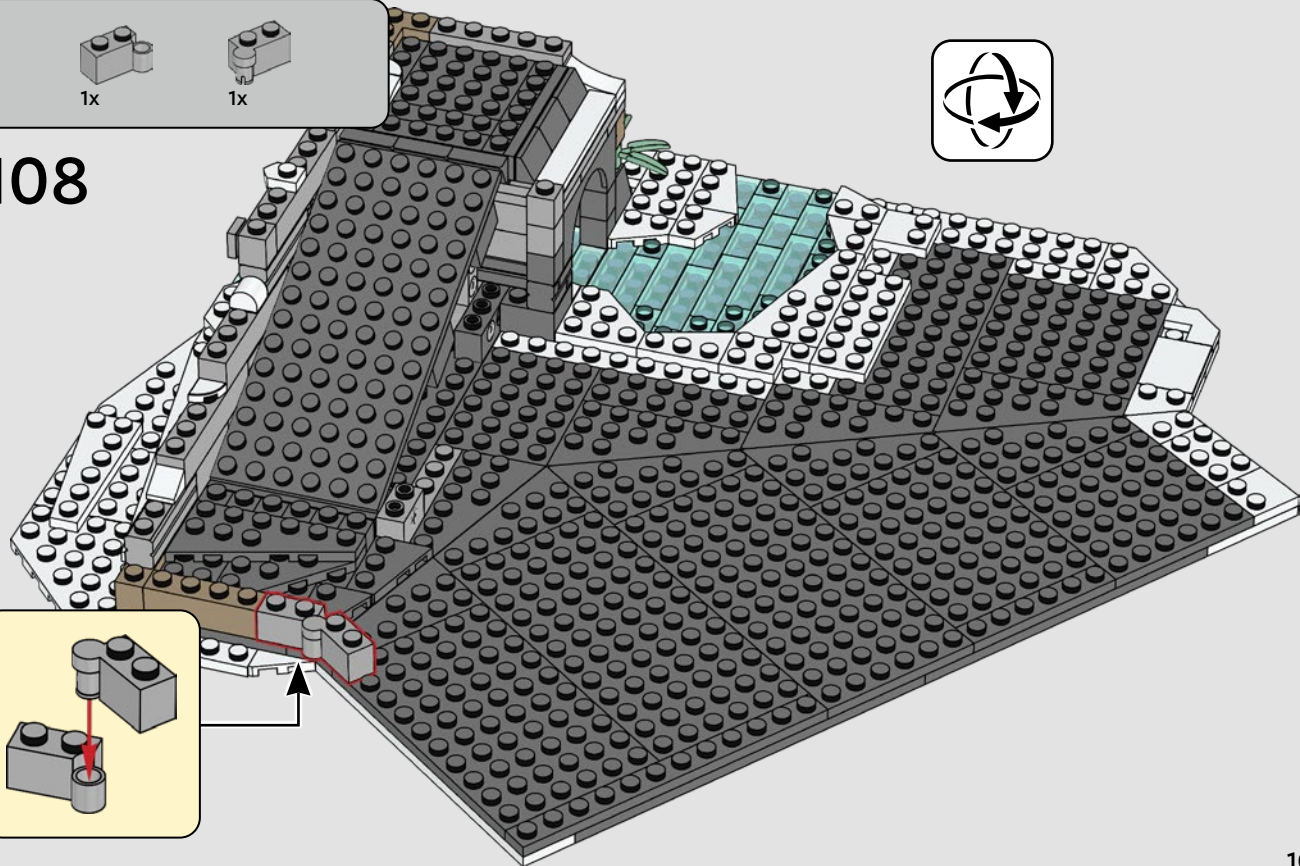

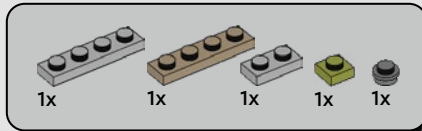

109

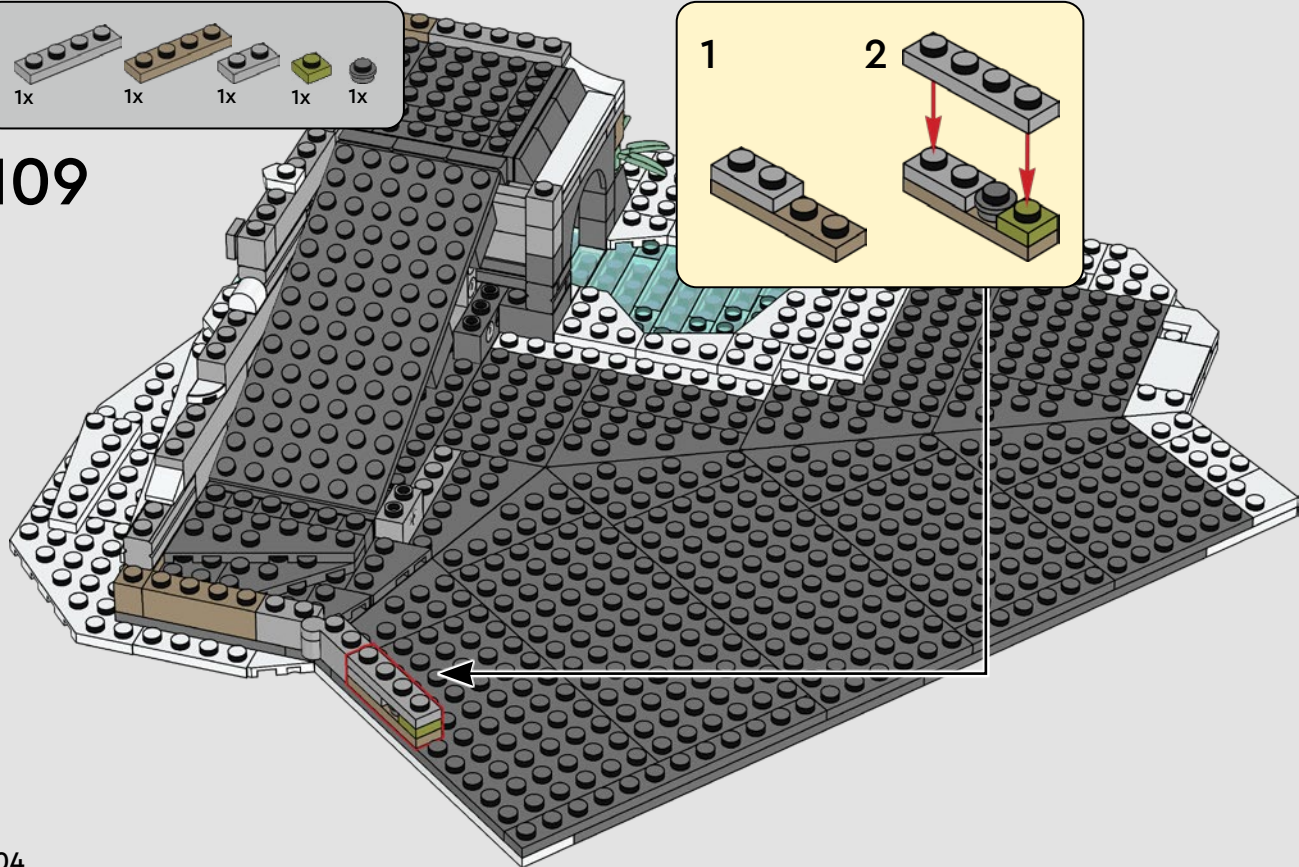
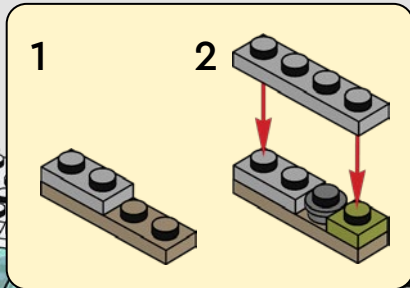

1x 1x 1x

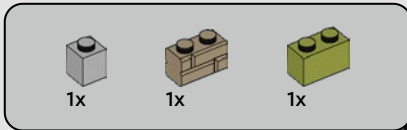

110

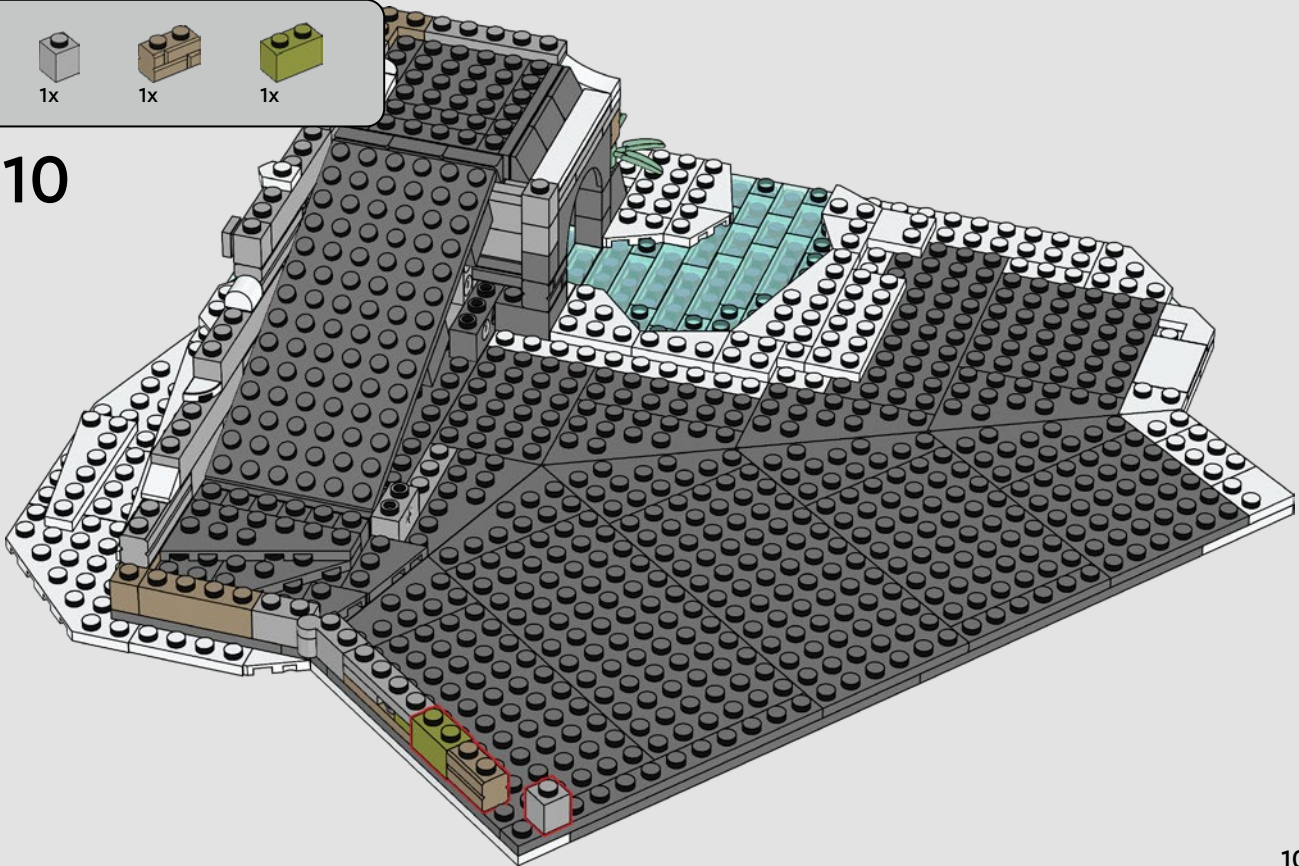

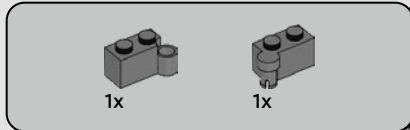

111

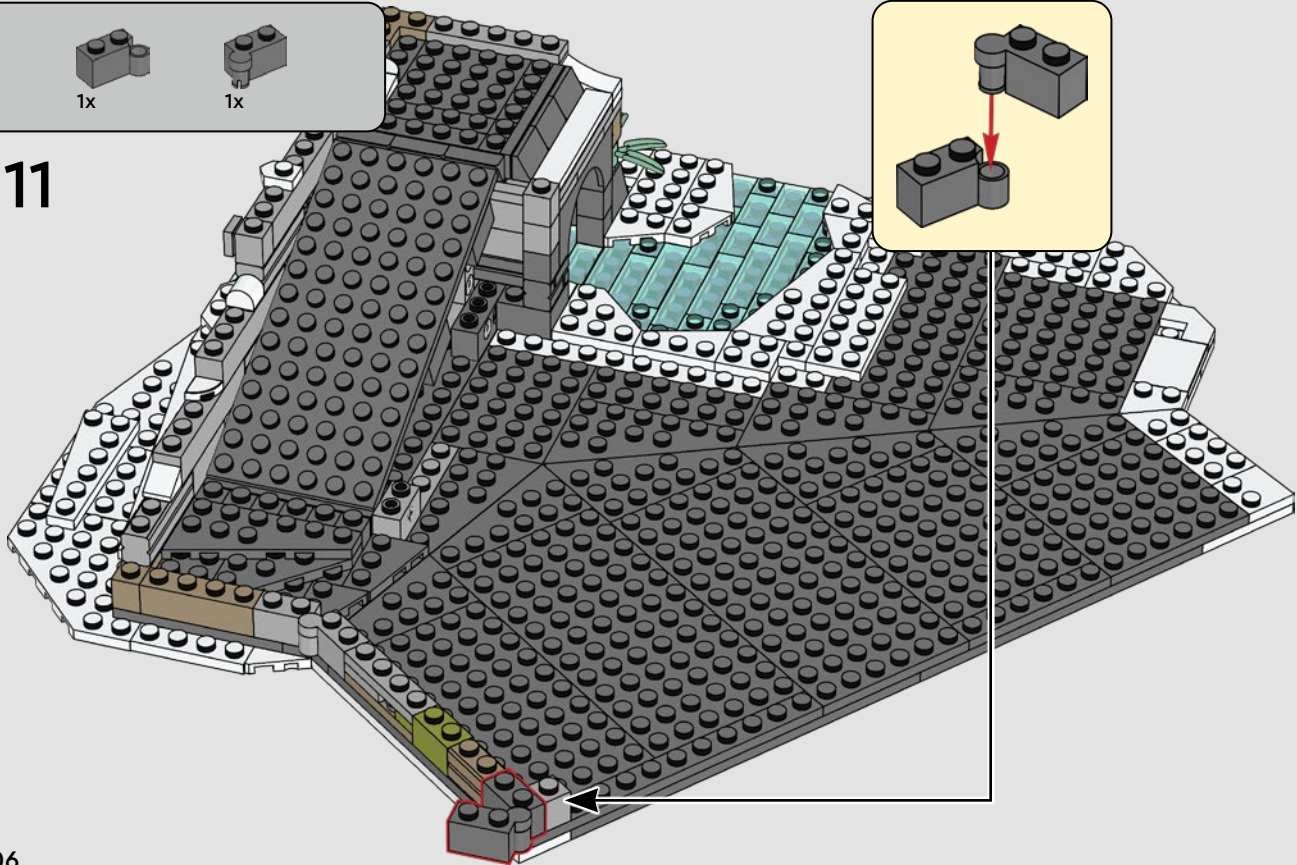
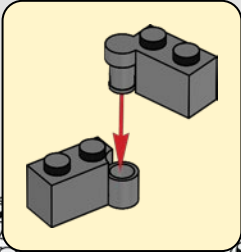



1x

112

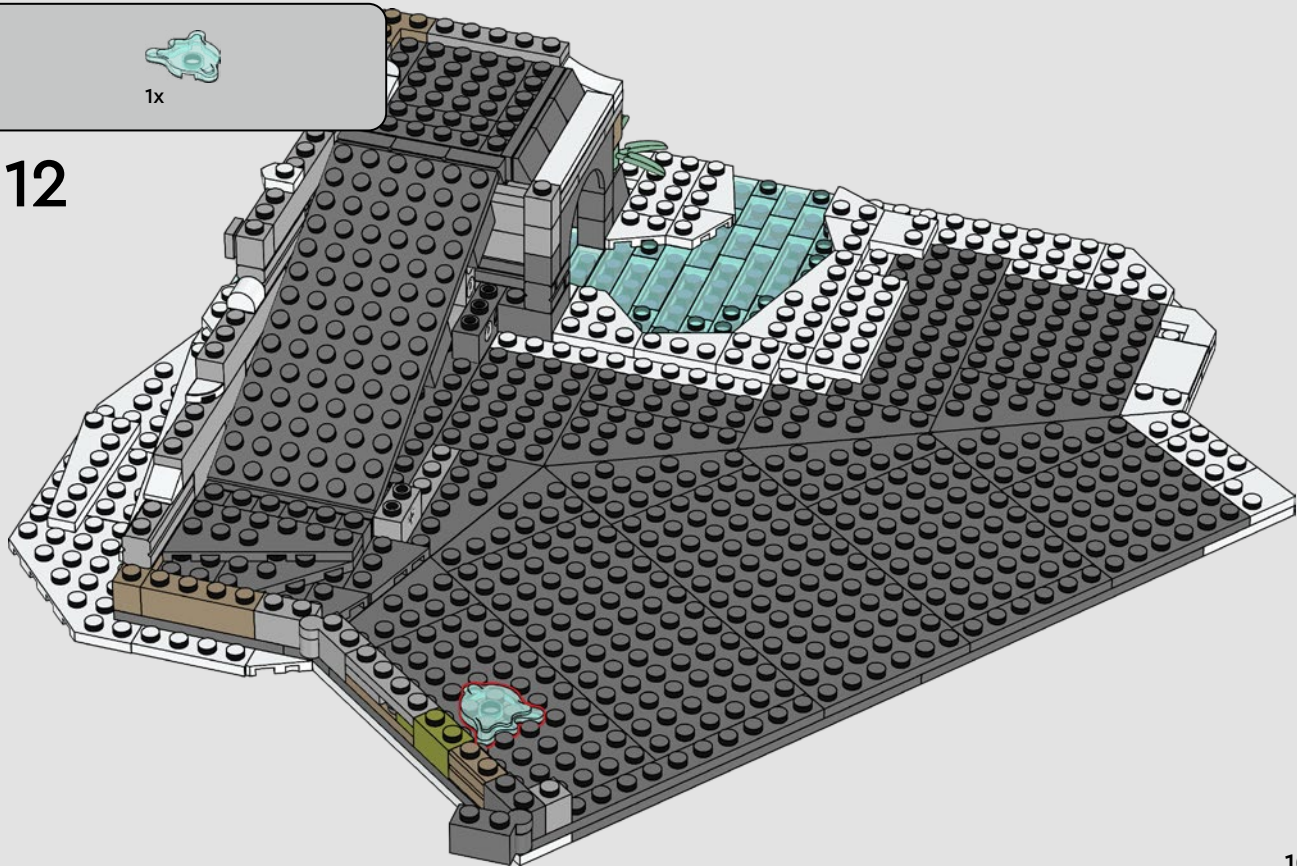

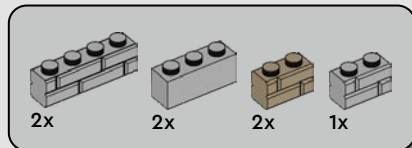

113

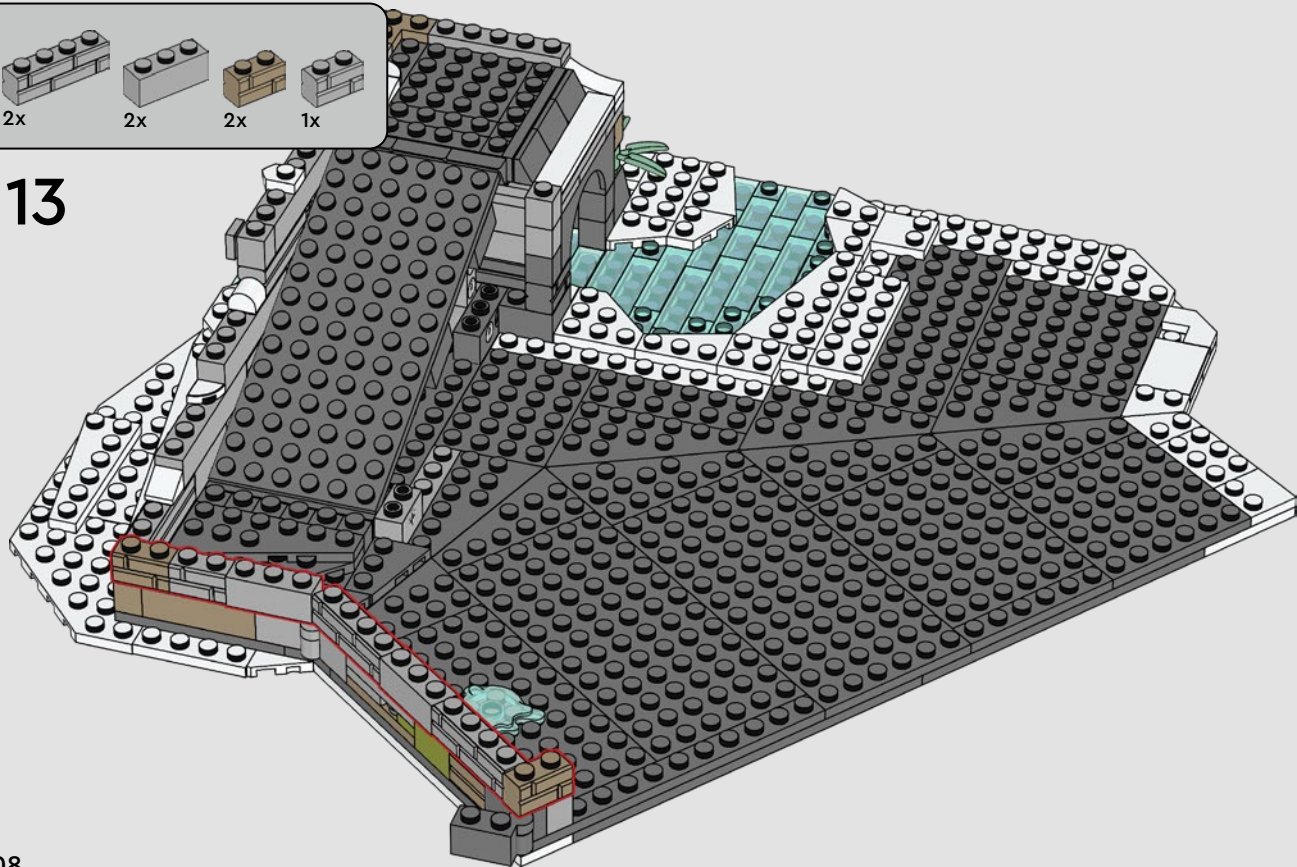

1x 1x 1x 1x

114

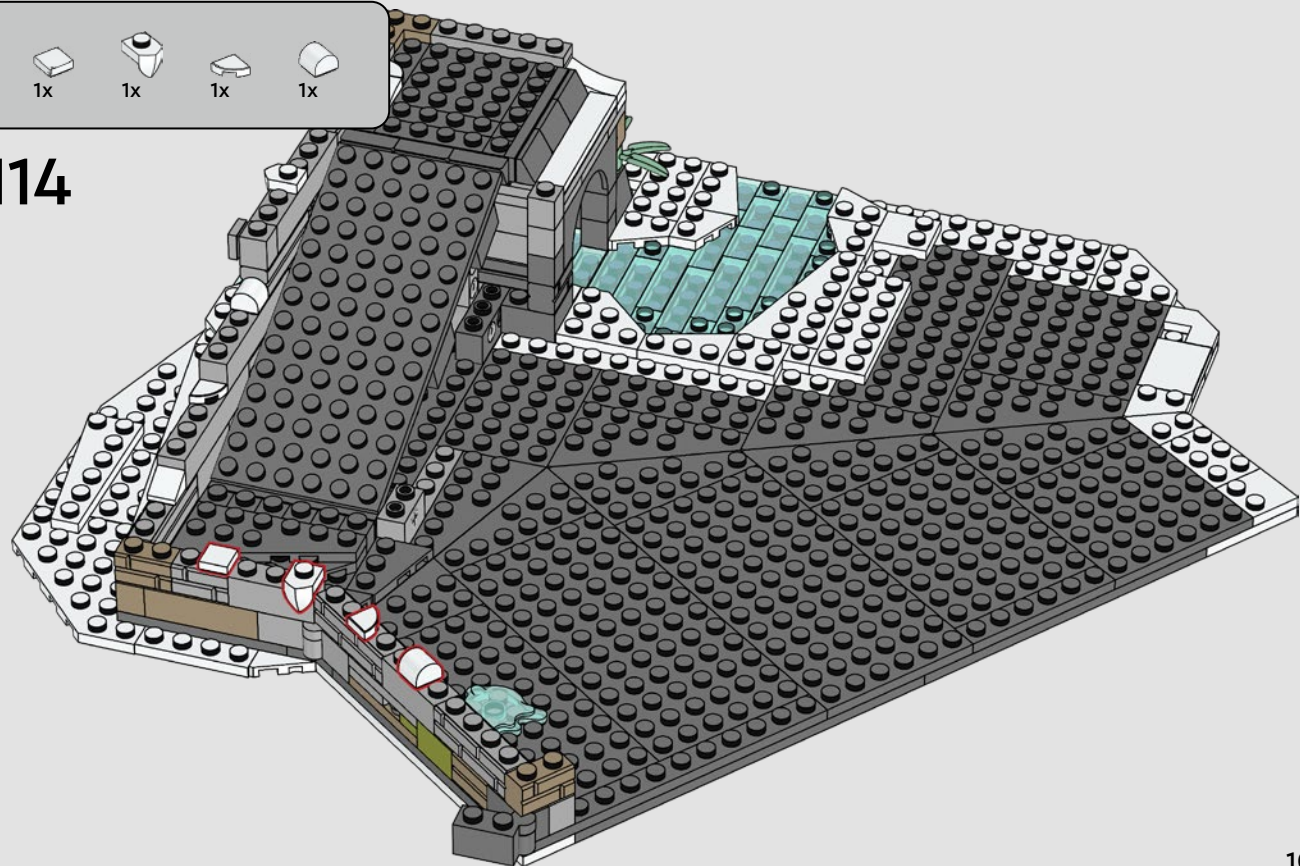



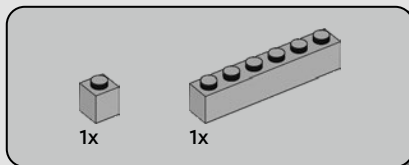

115

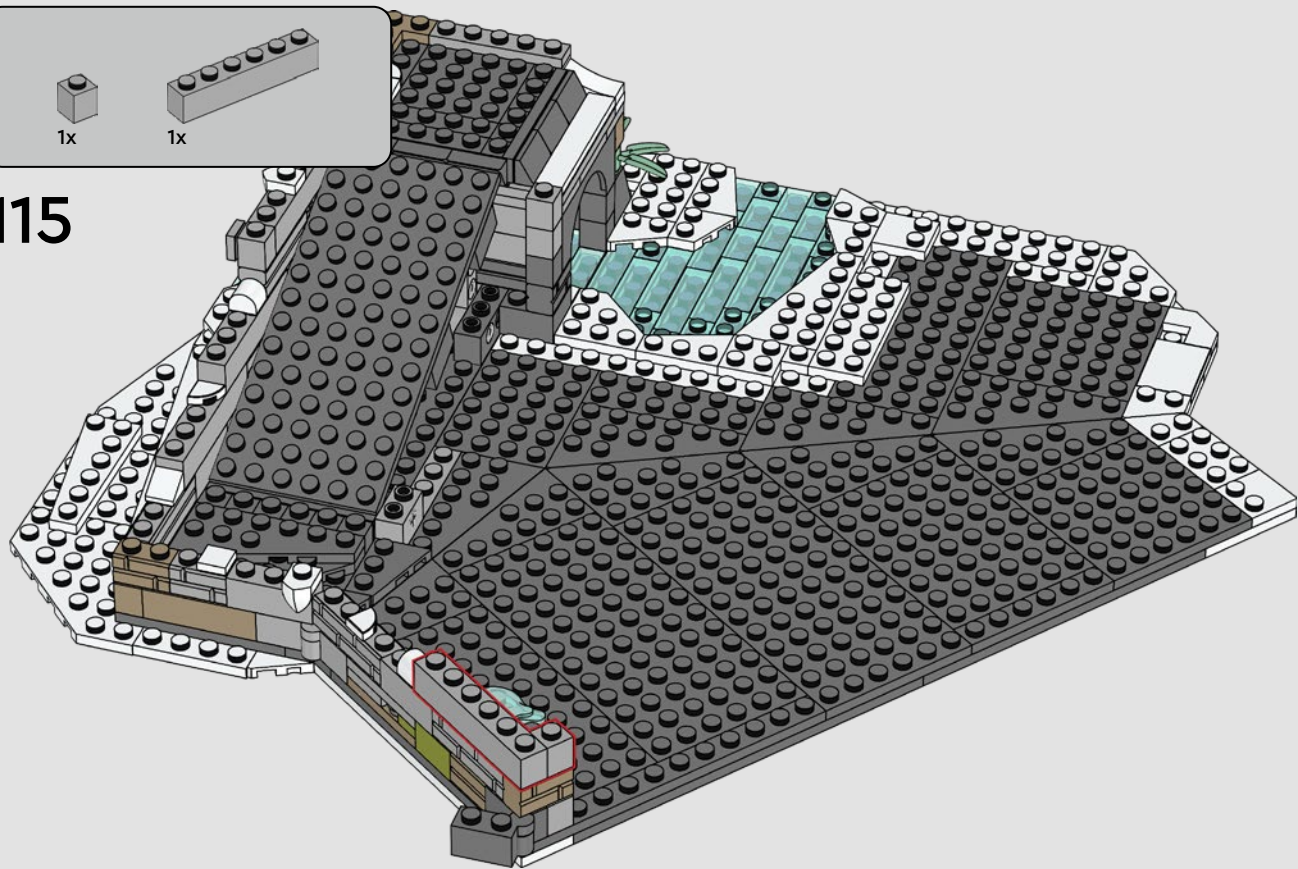

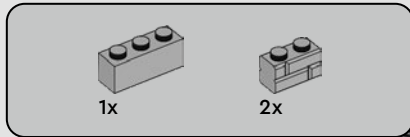

116

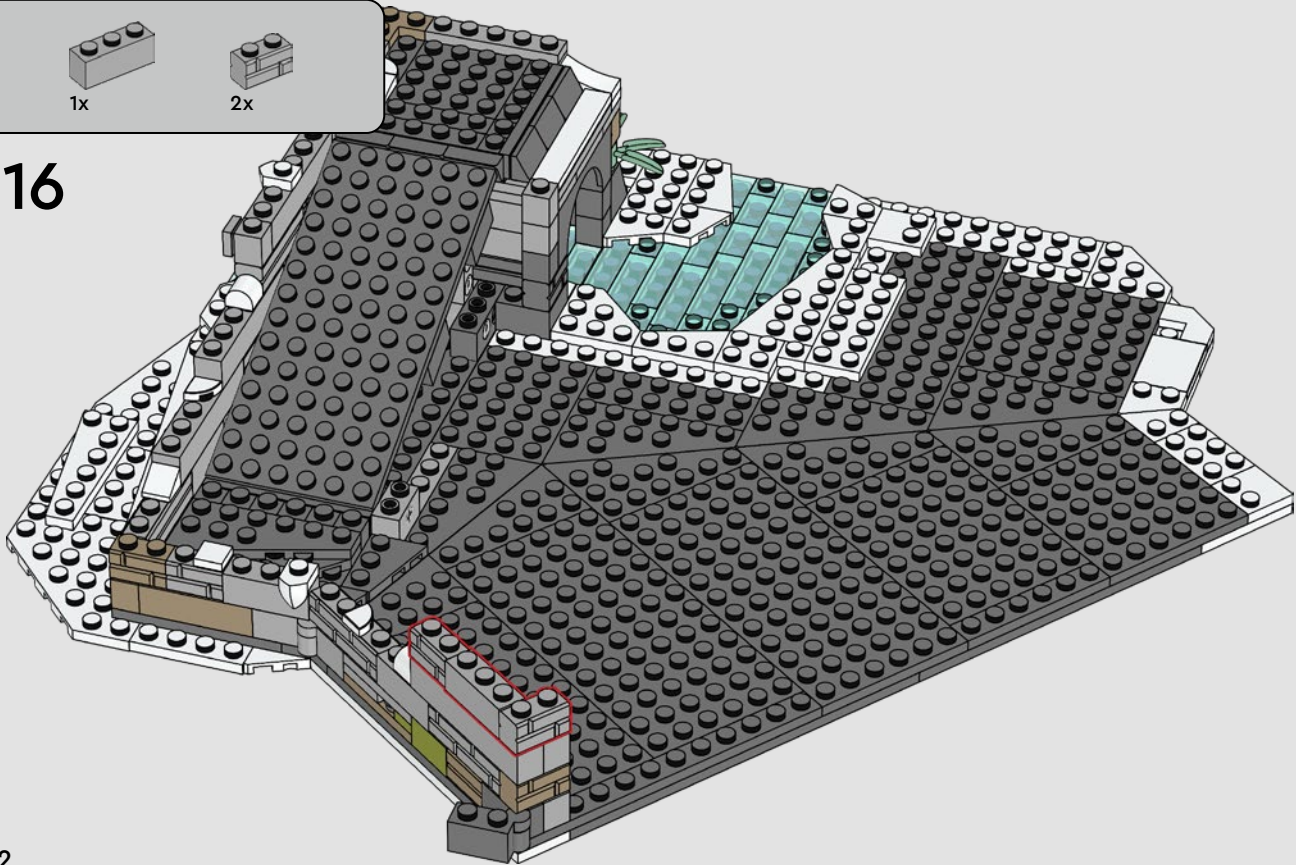



1x

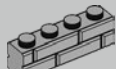

1x

117

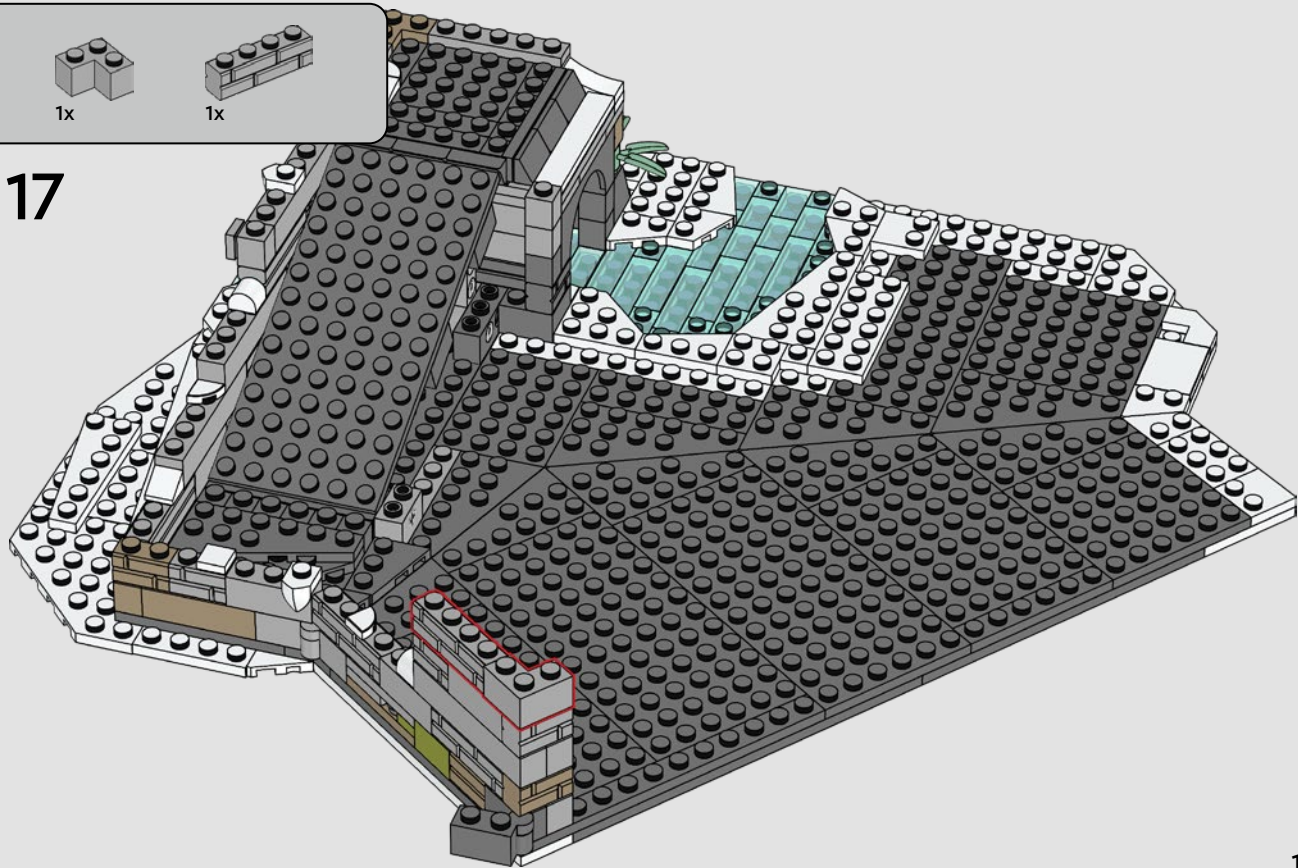



1x



1x

118

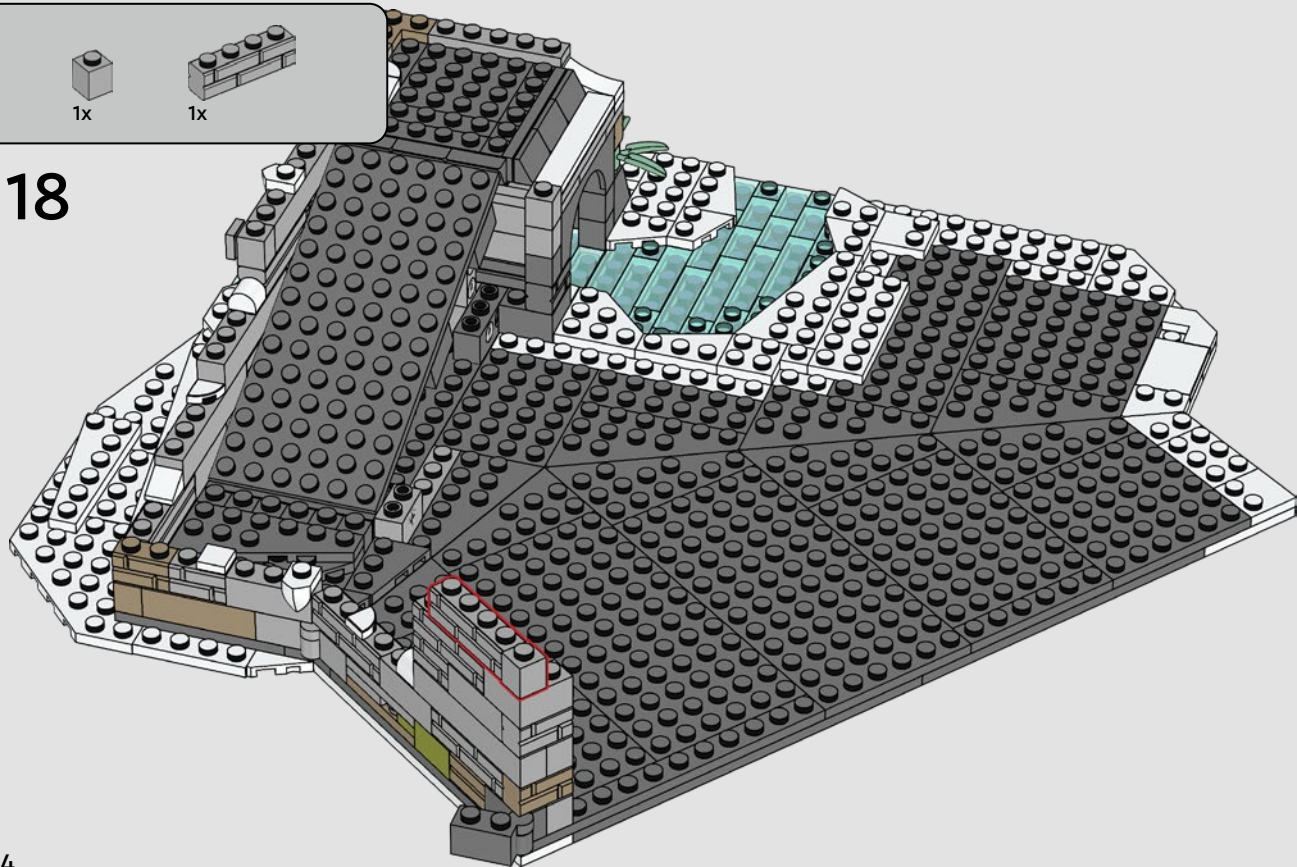

114

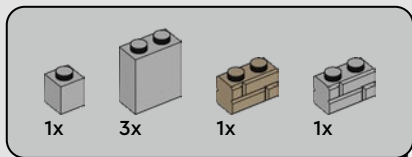

119

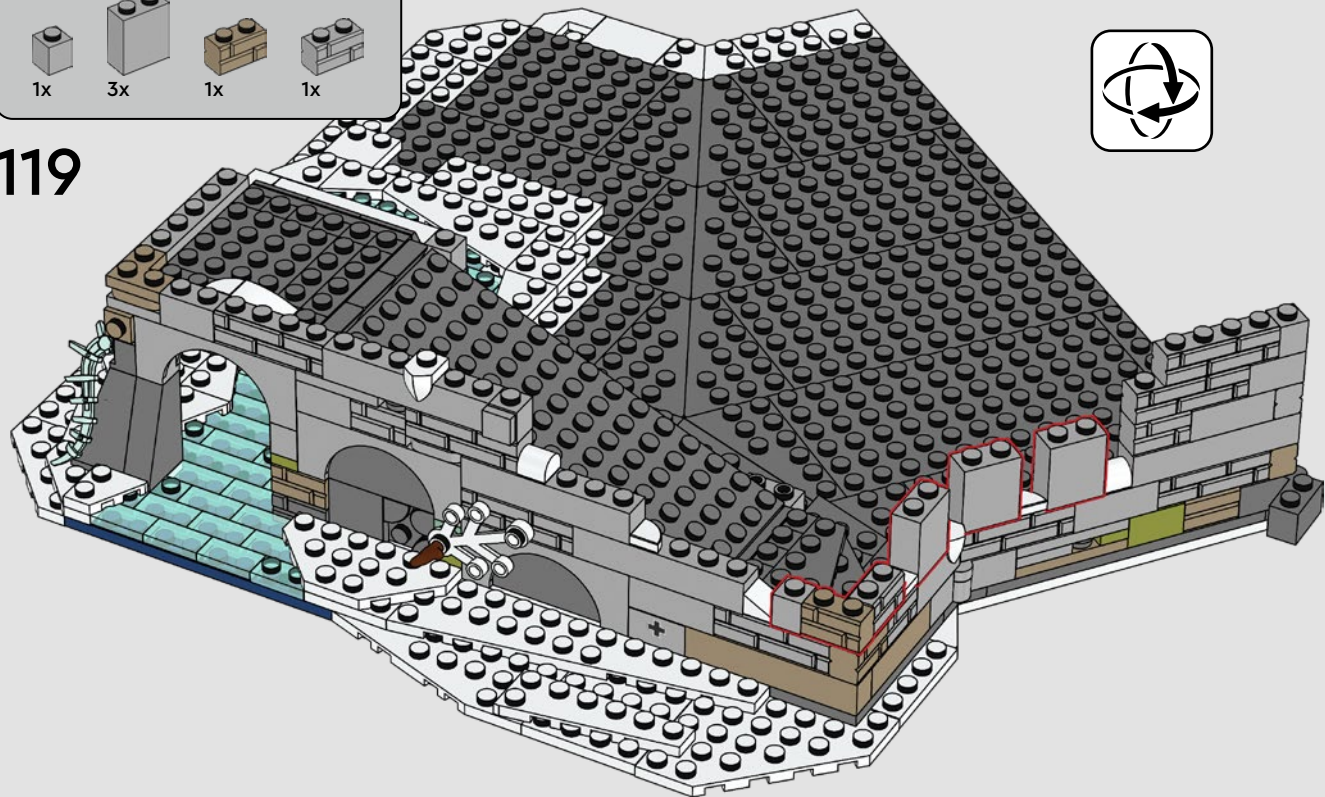



1x



1x

120

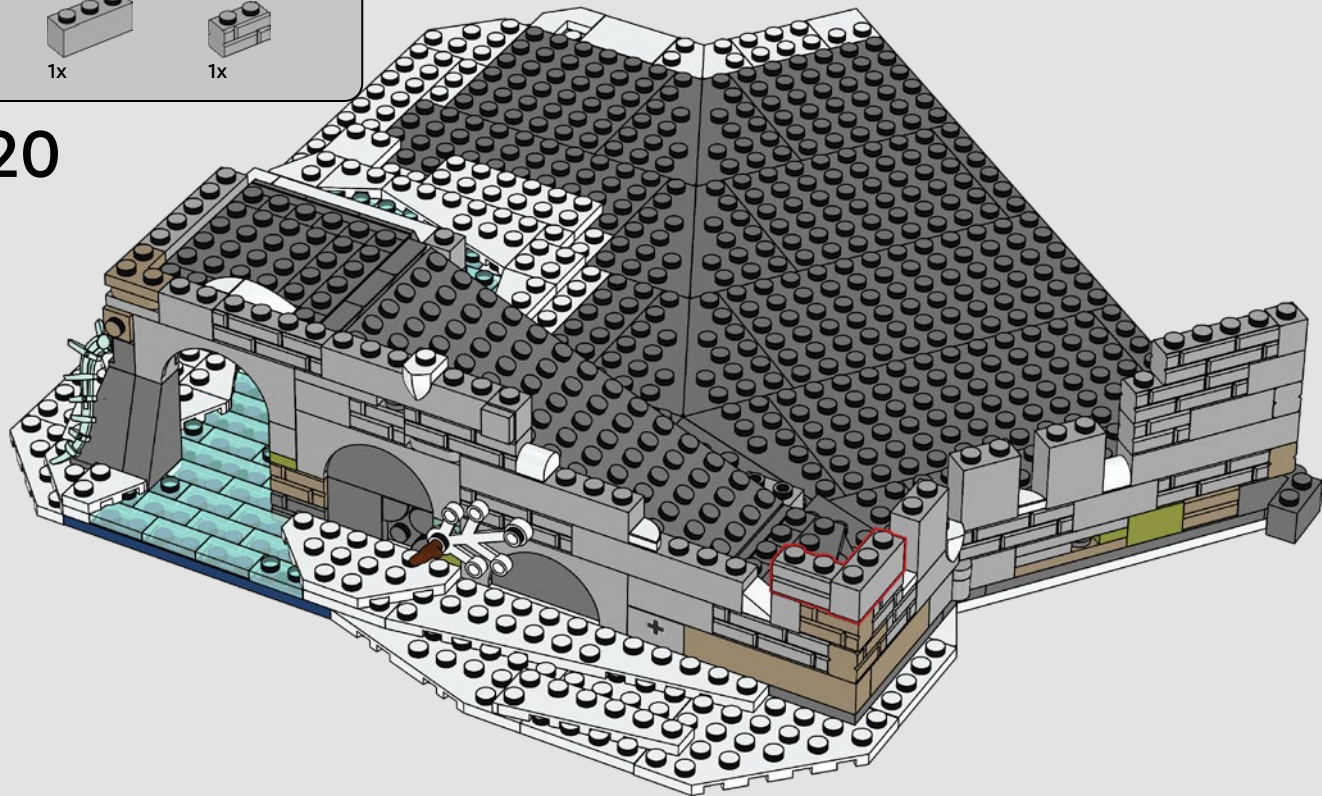

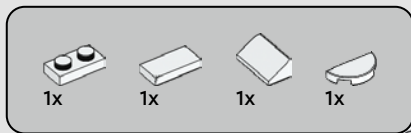

121

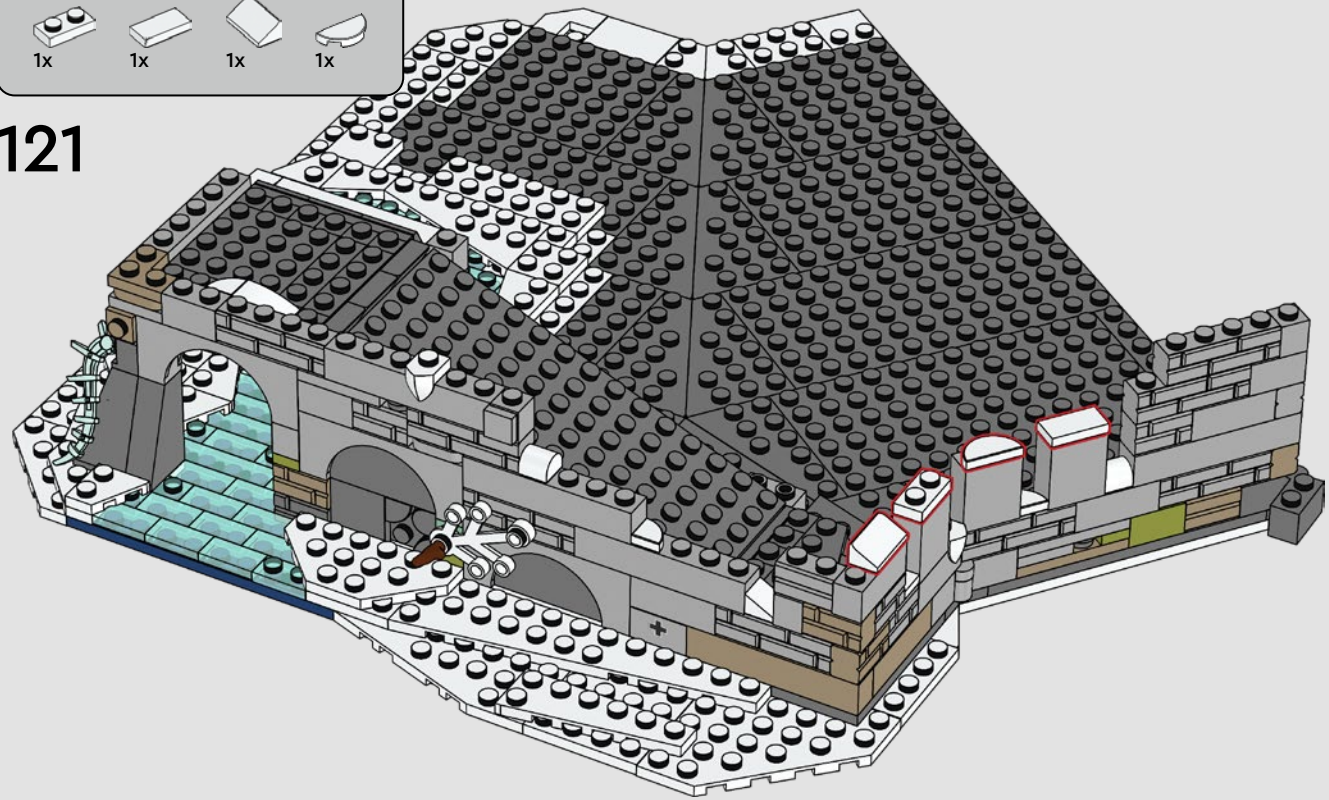

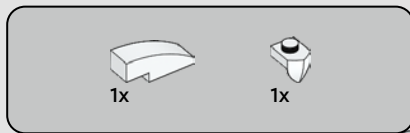

122

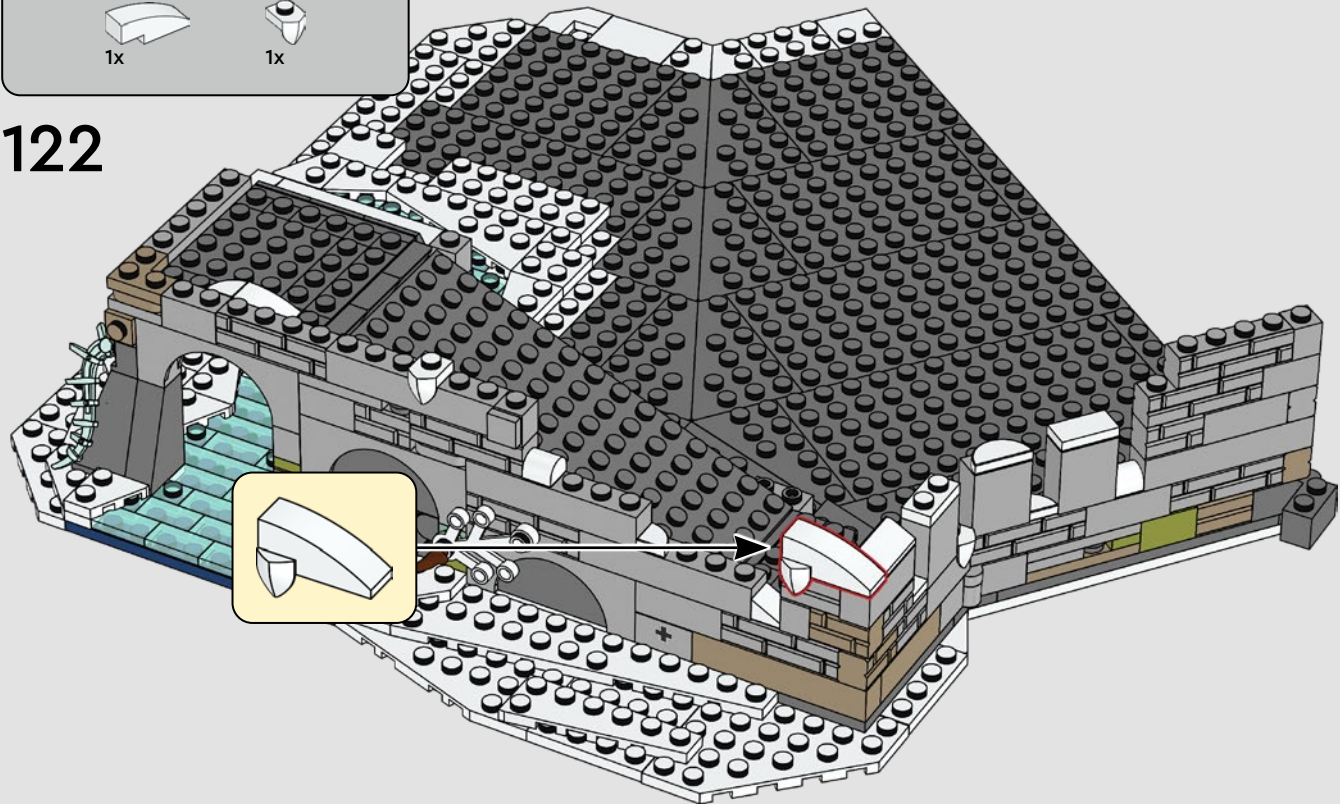

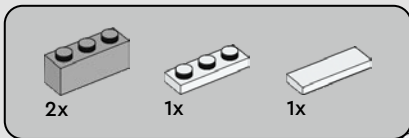

123

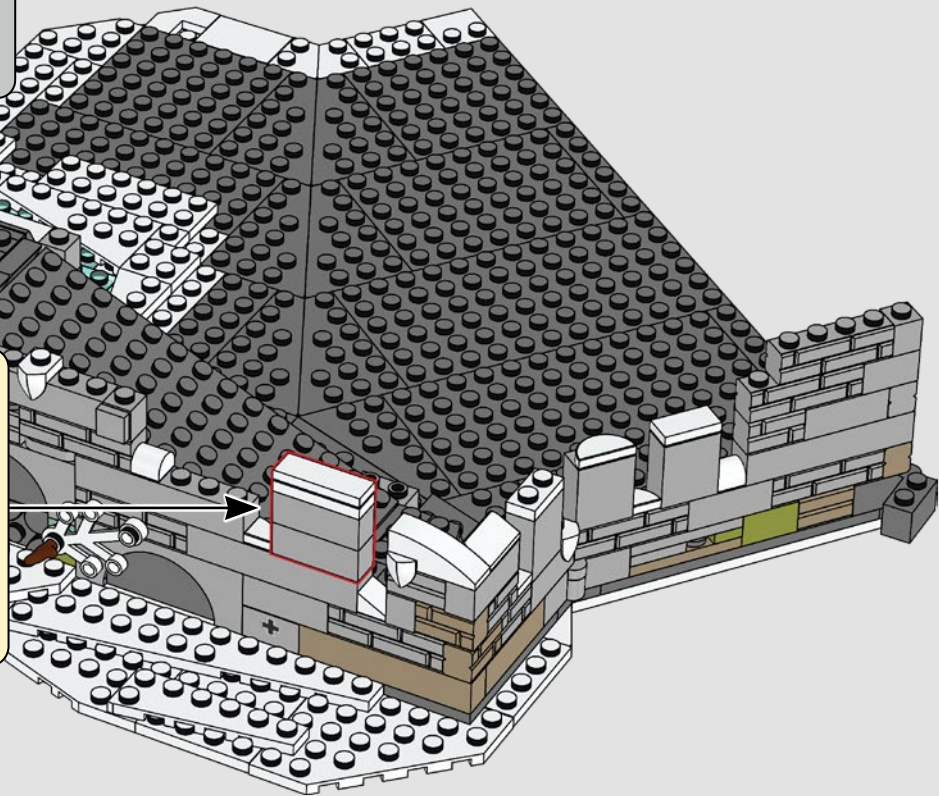
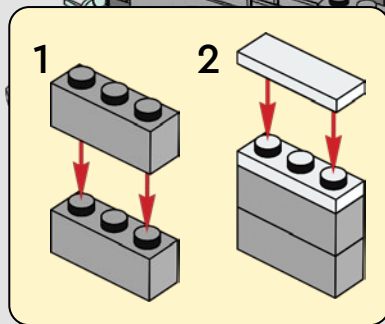

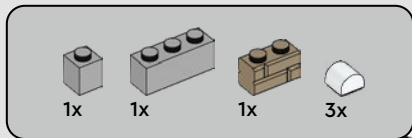

124

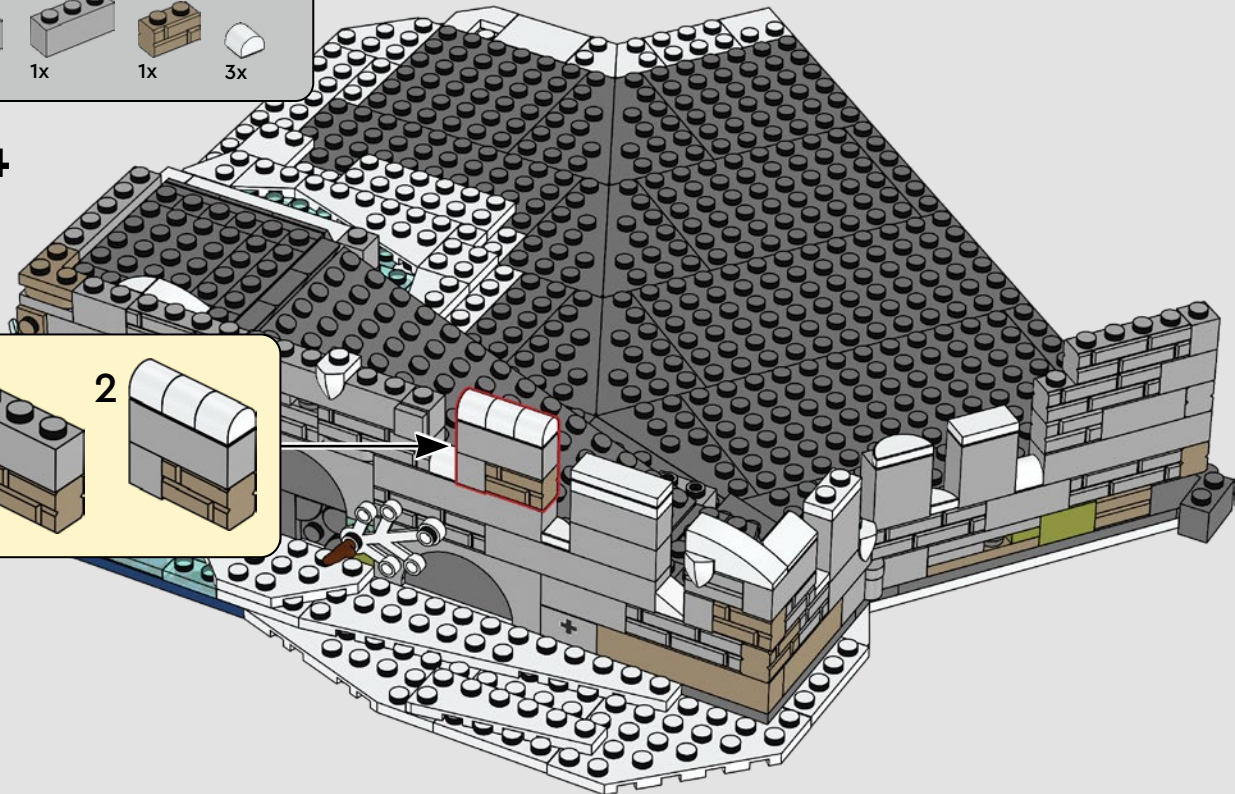
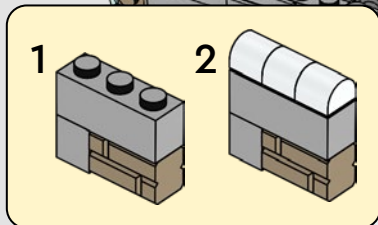

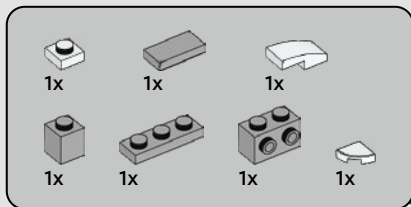

125

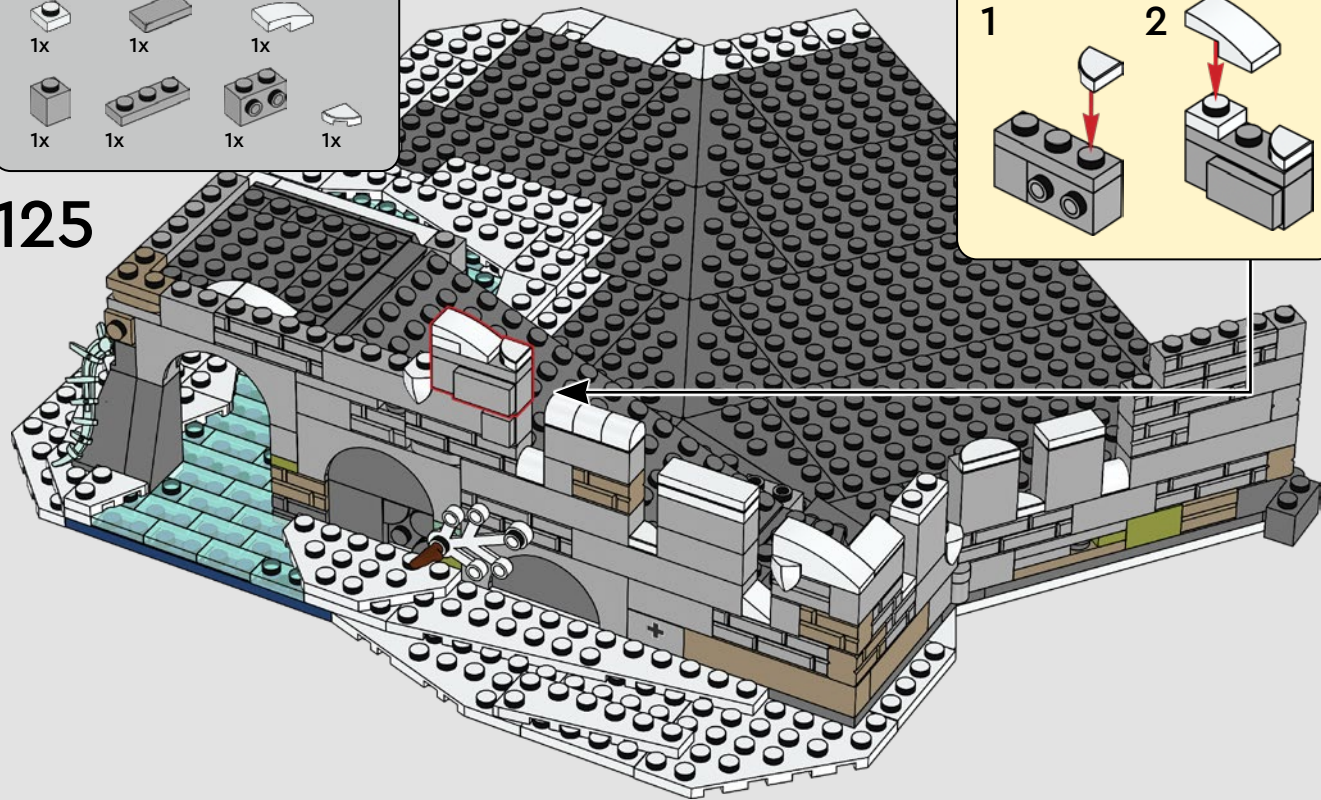
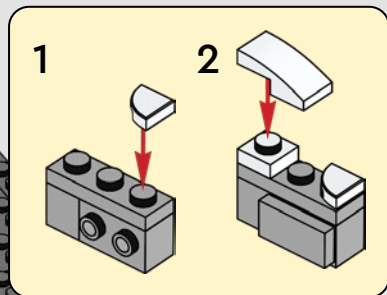

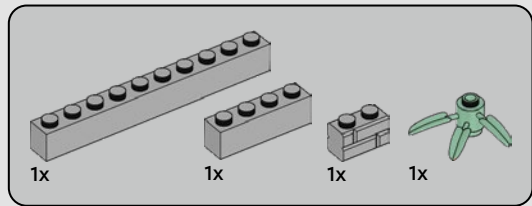

126

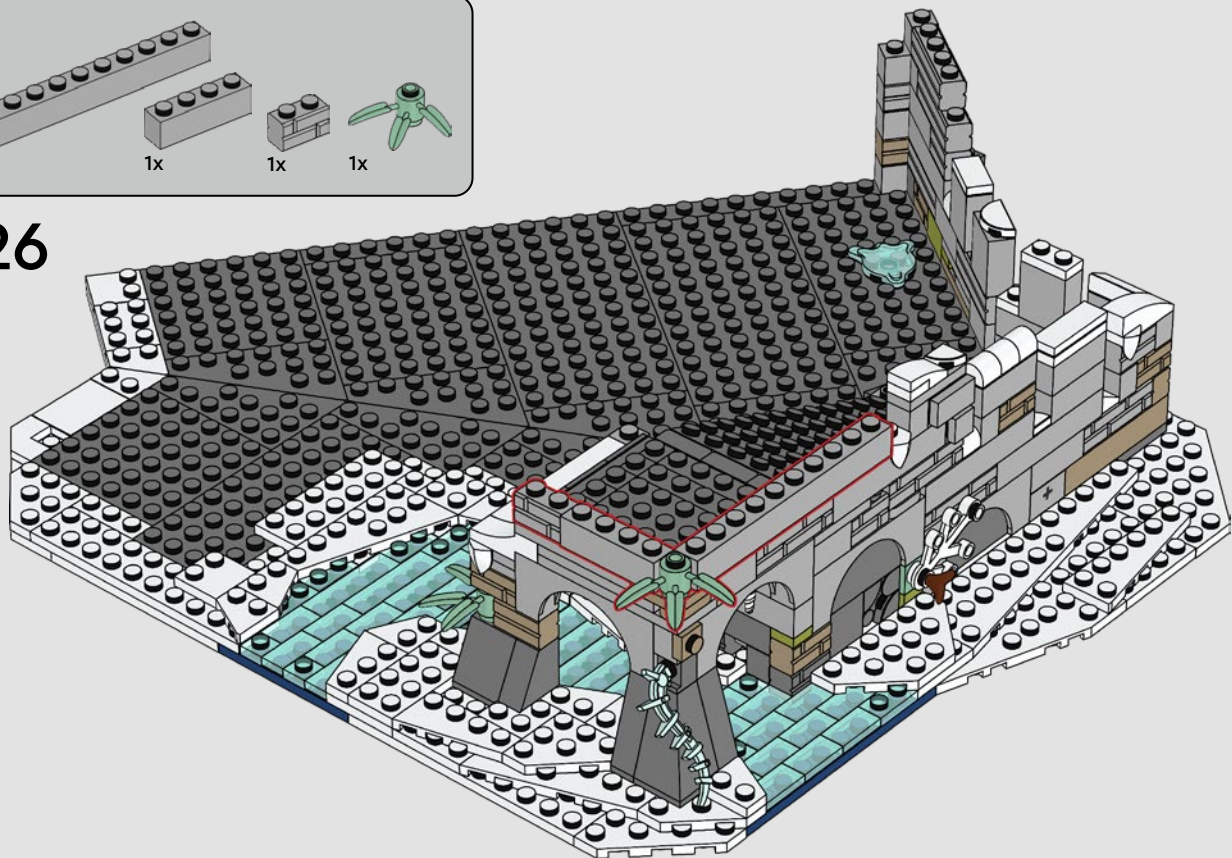



1x



1x



1x

127

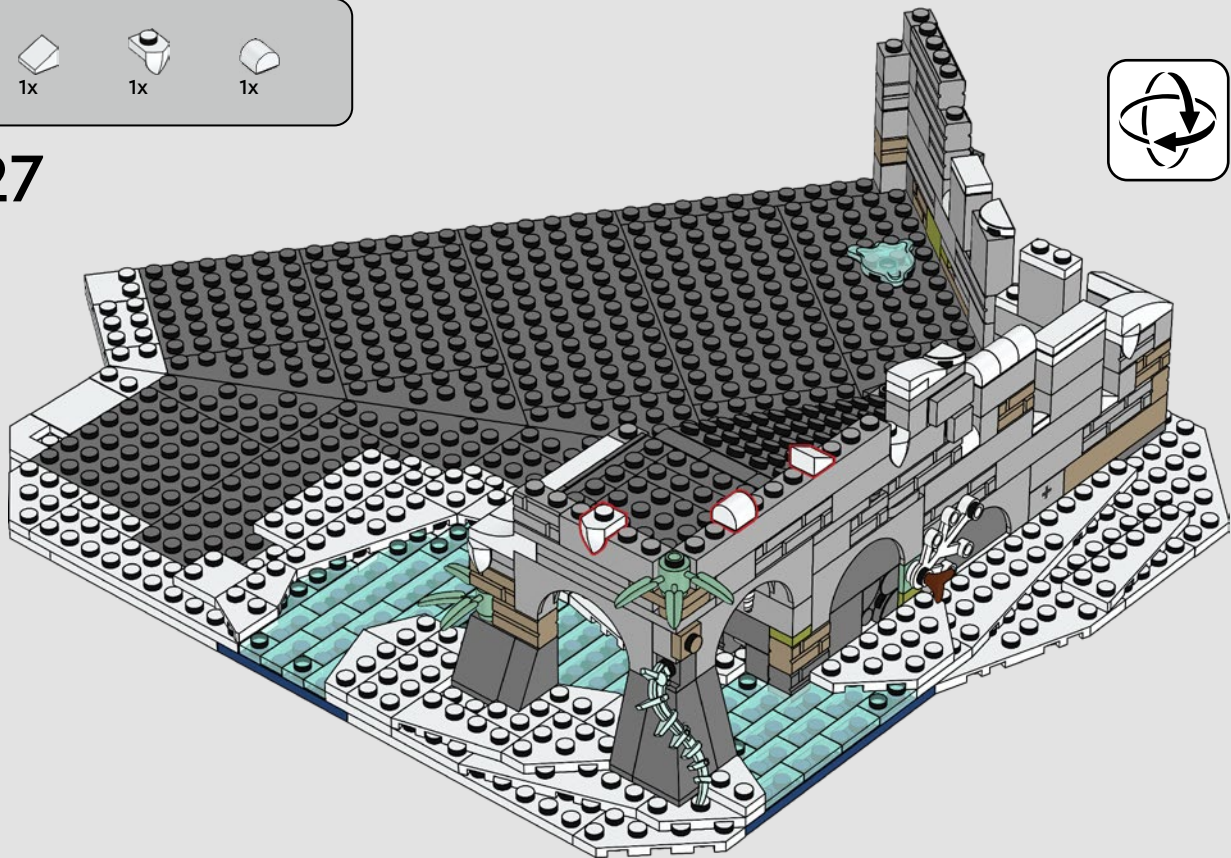

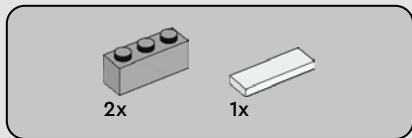

128

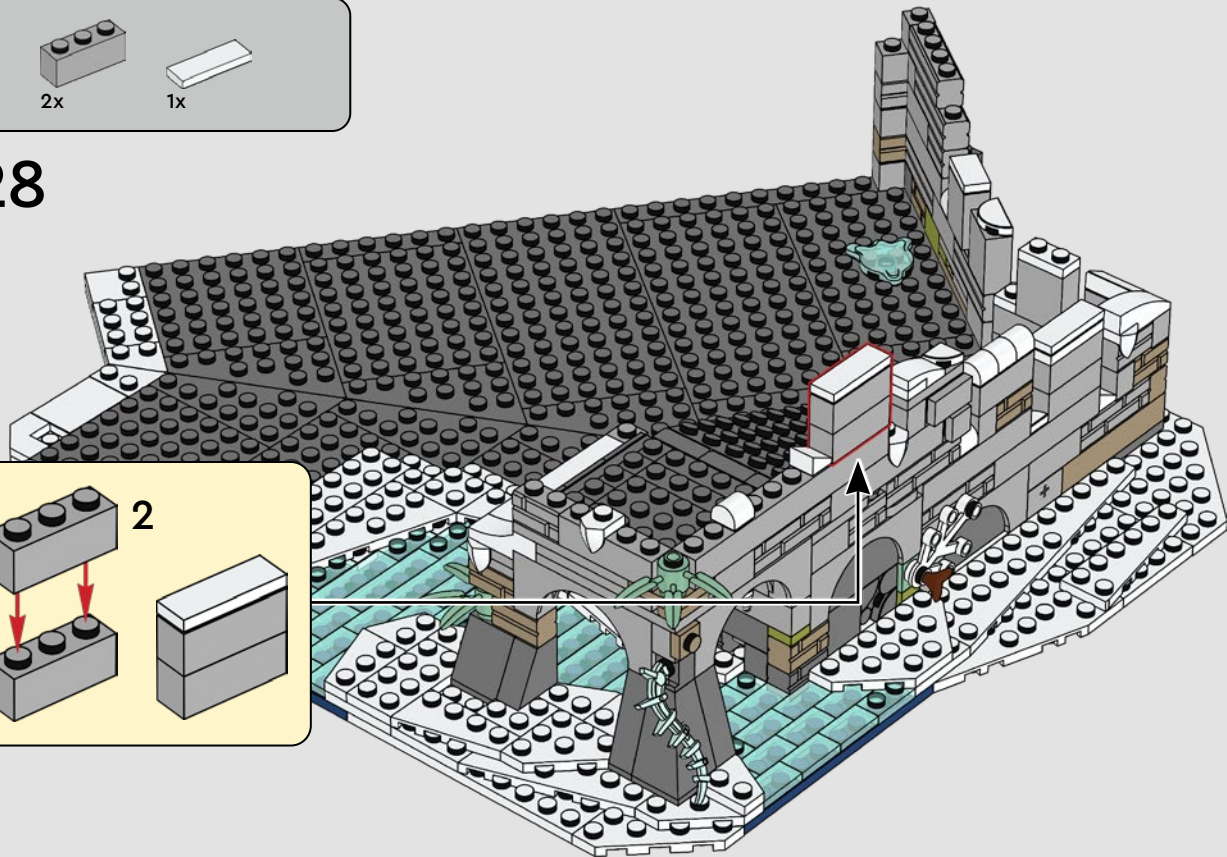
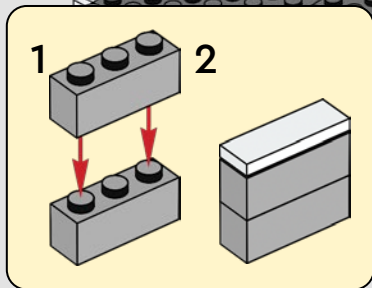

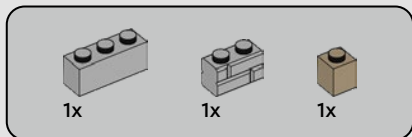

129

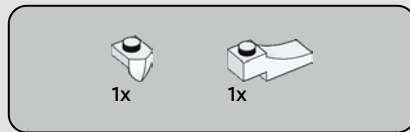
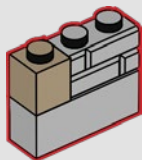

130

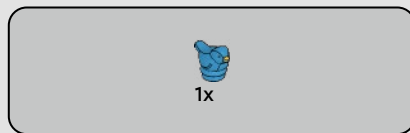
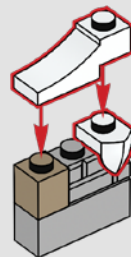

131

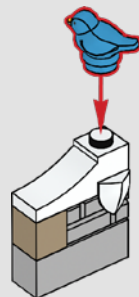

132

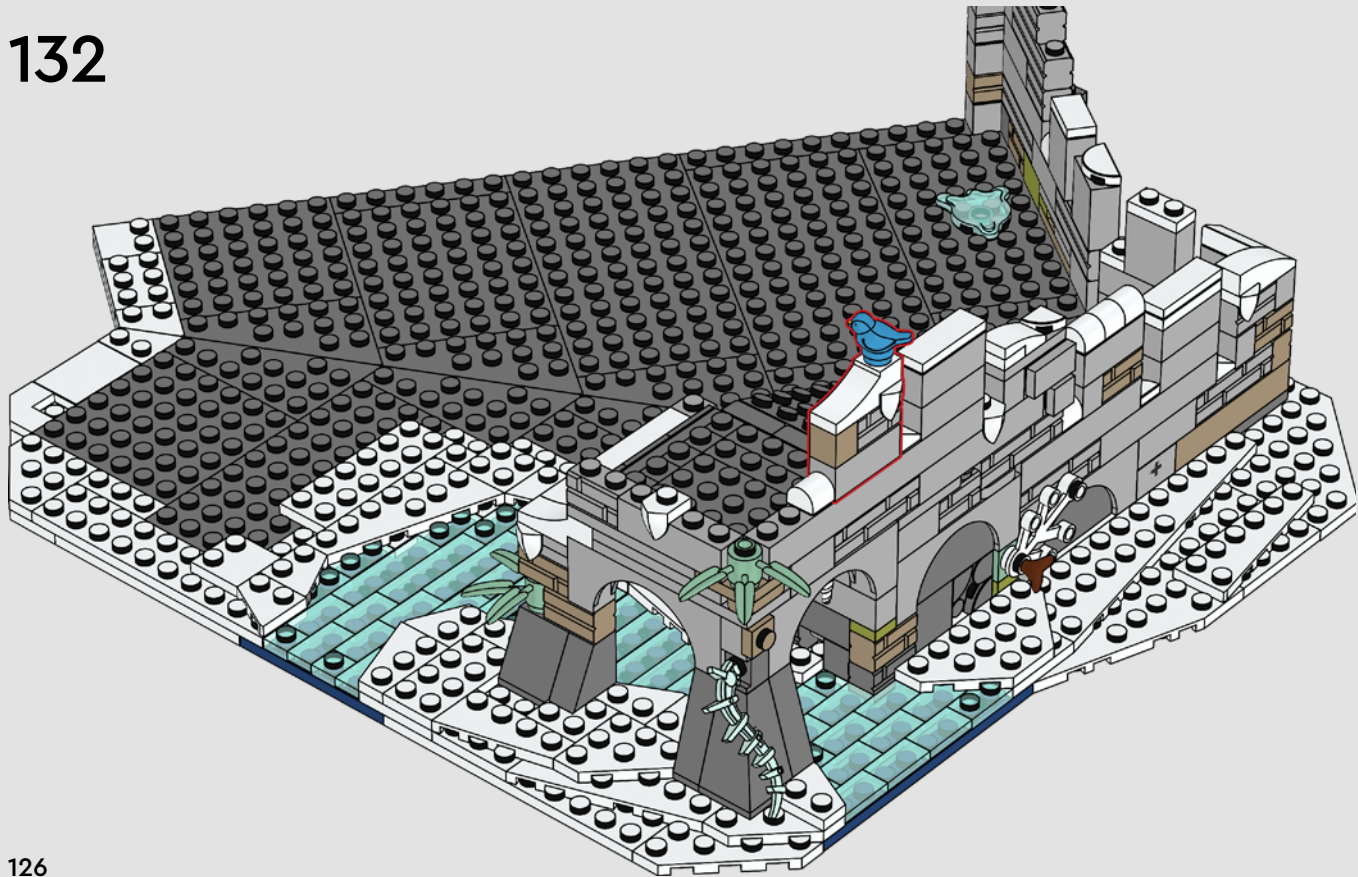

126

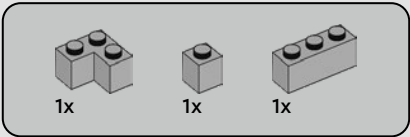

133

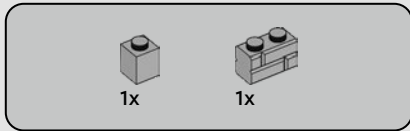
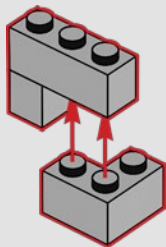

134

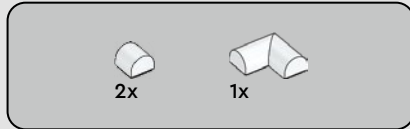
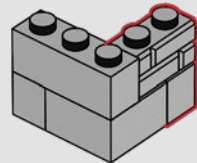

135

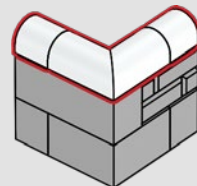

136

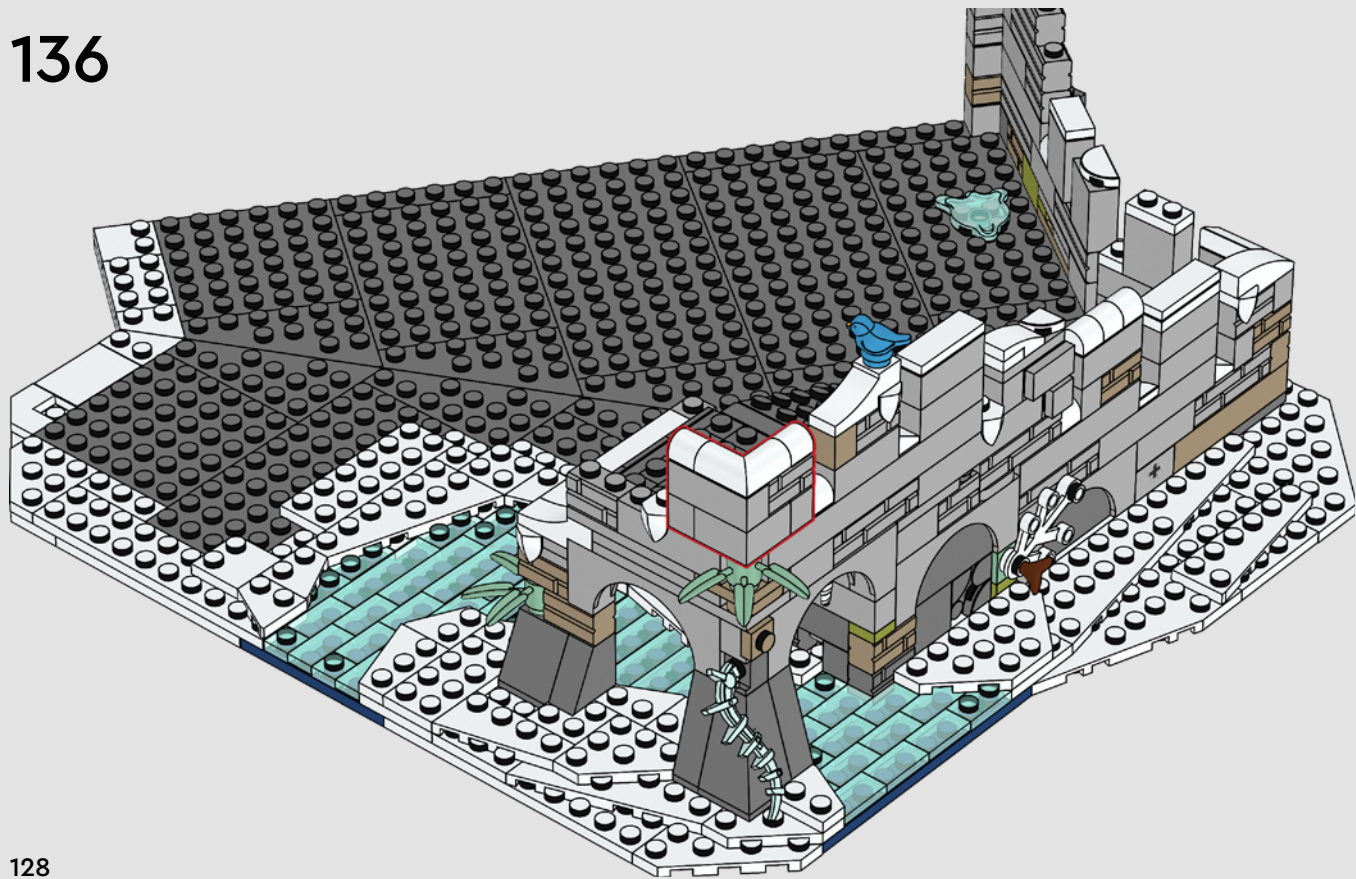

128

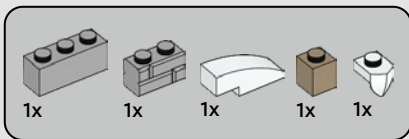

137

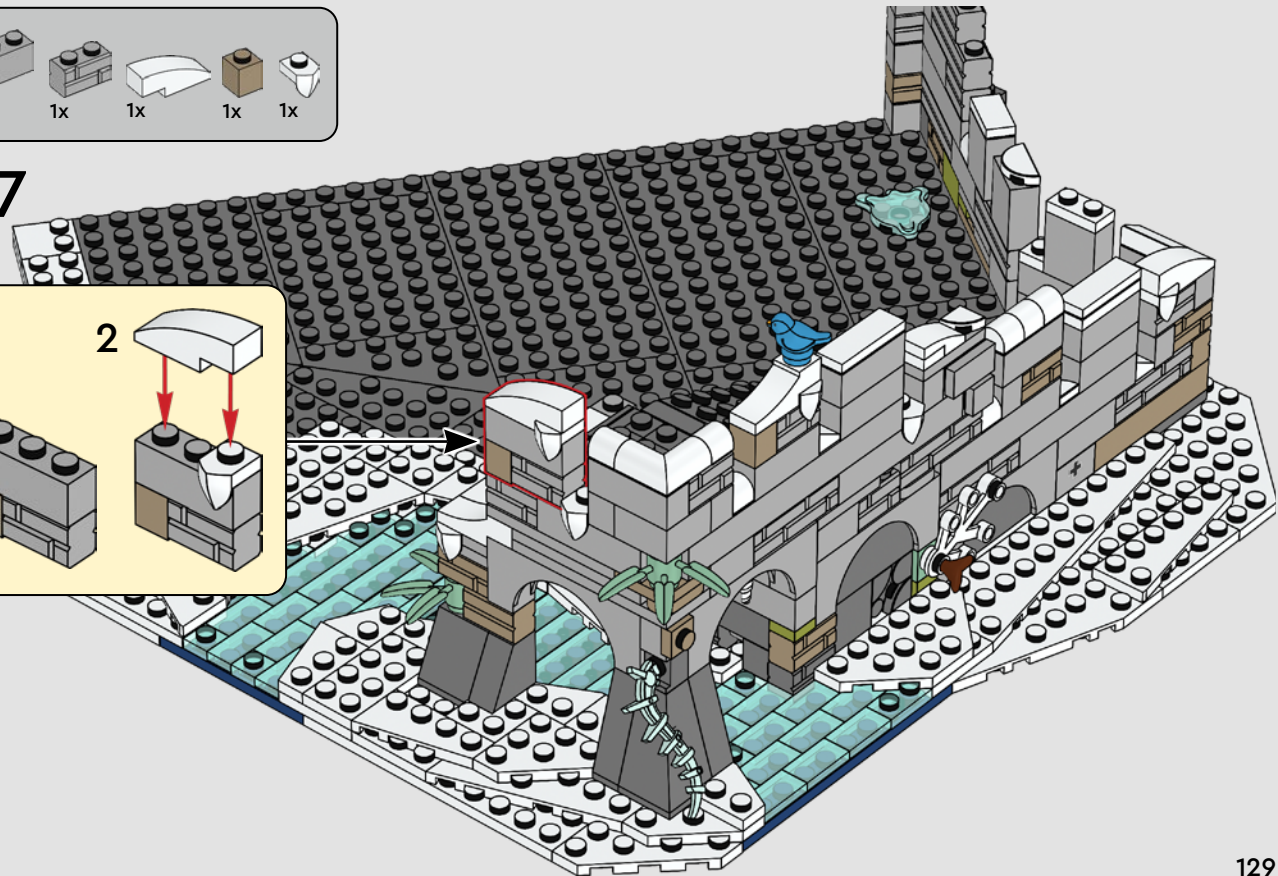
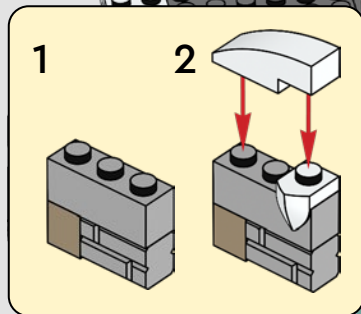

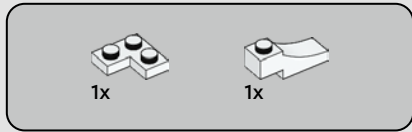

138

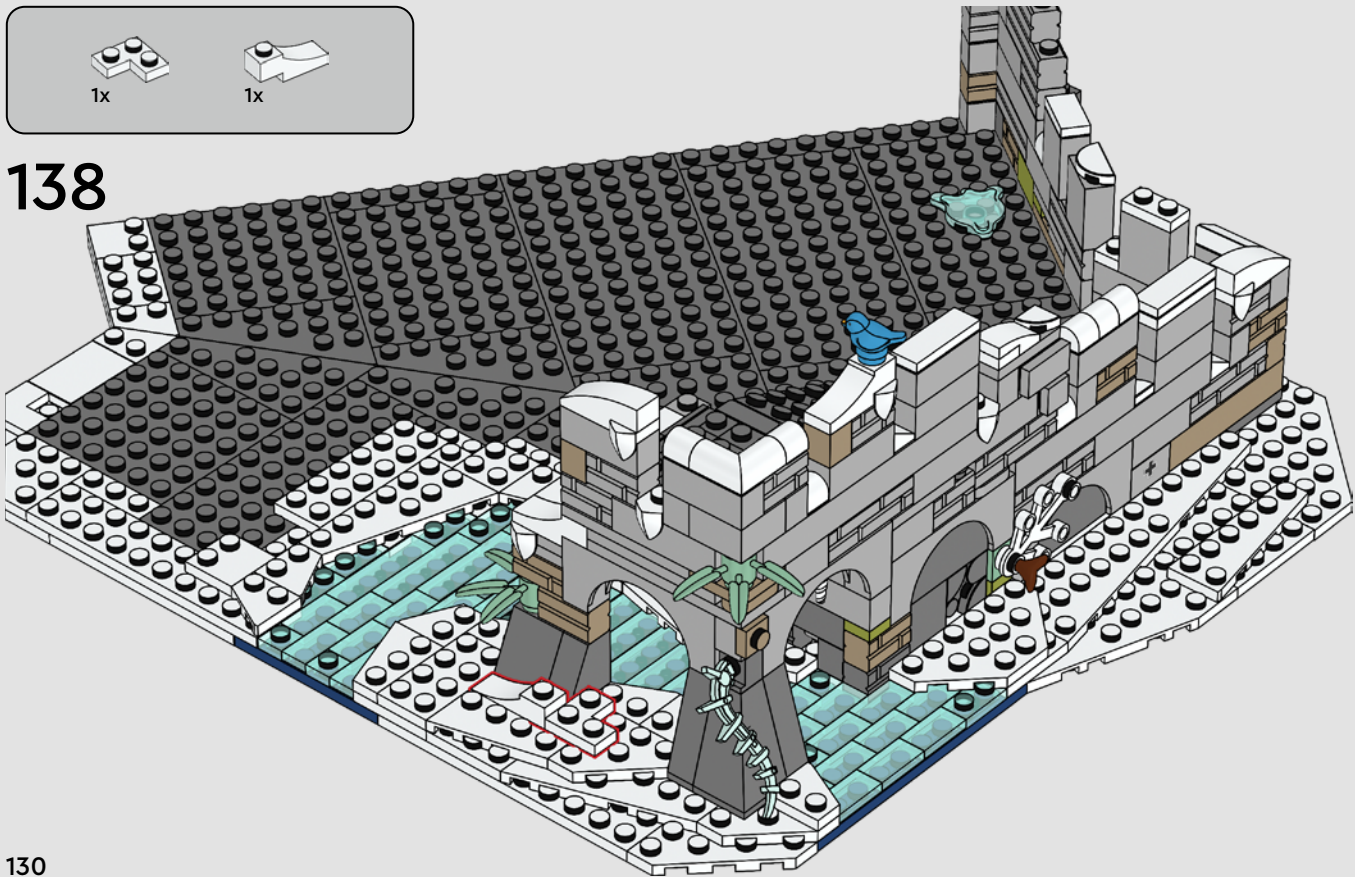

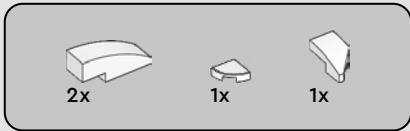

139

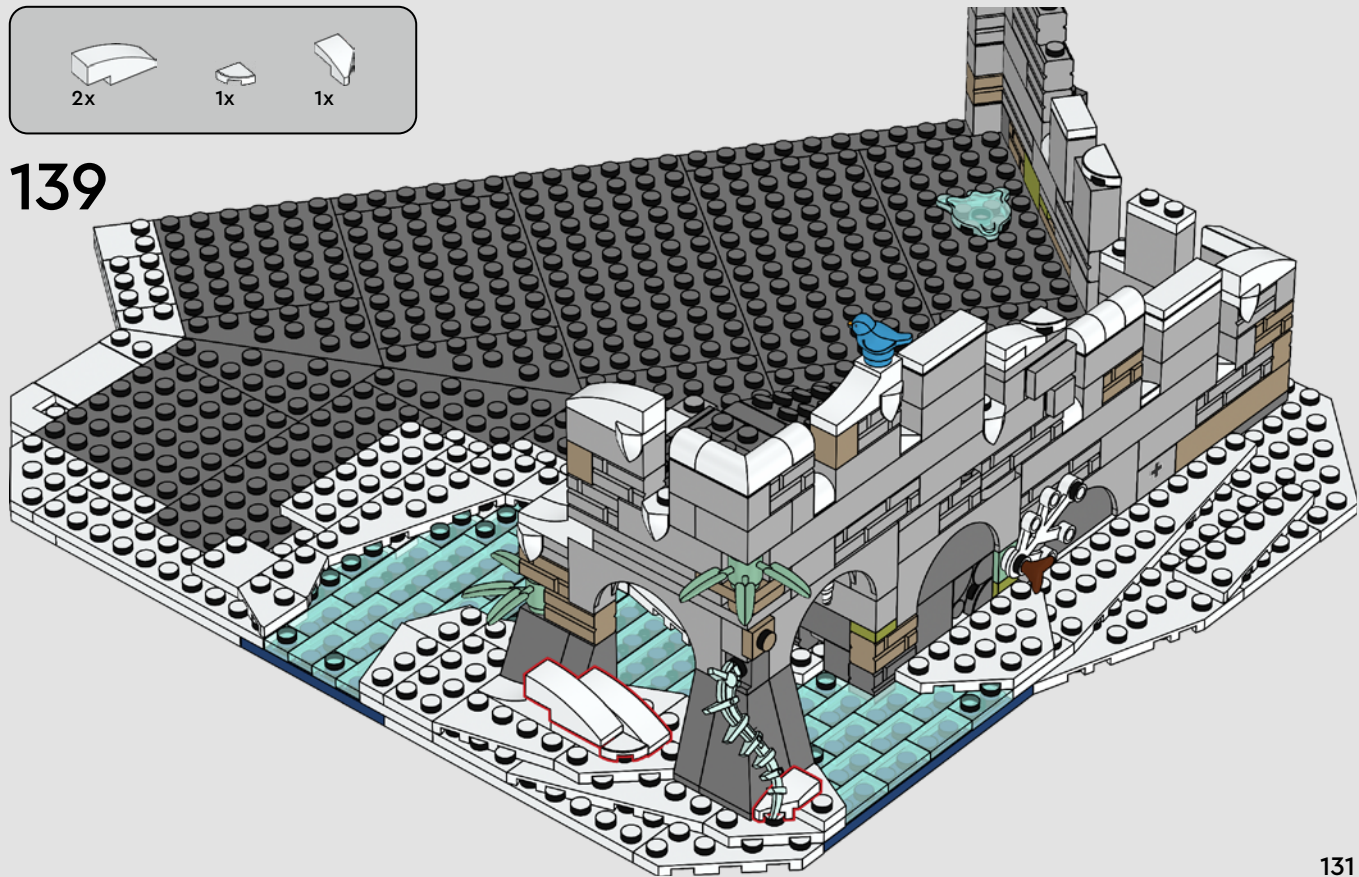

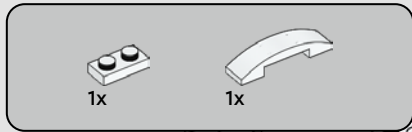

140

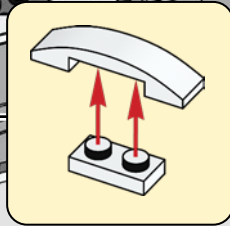
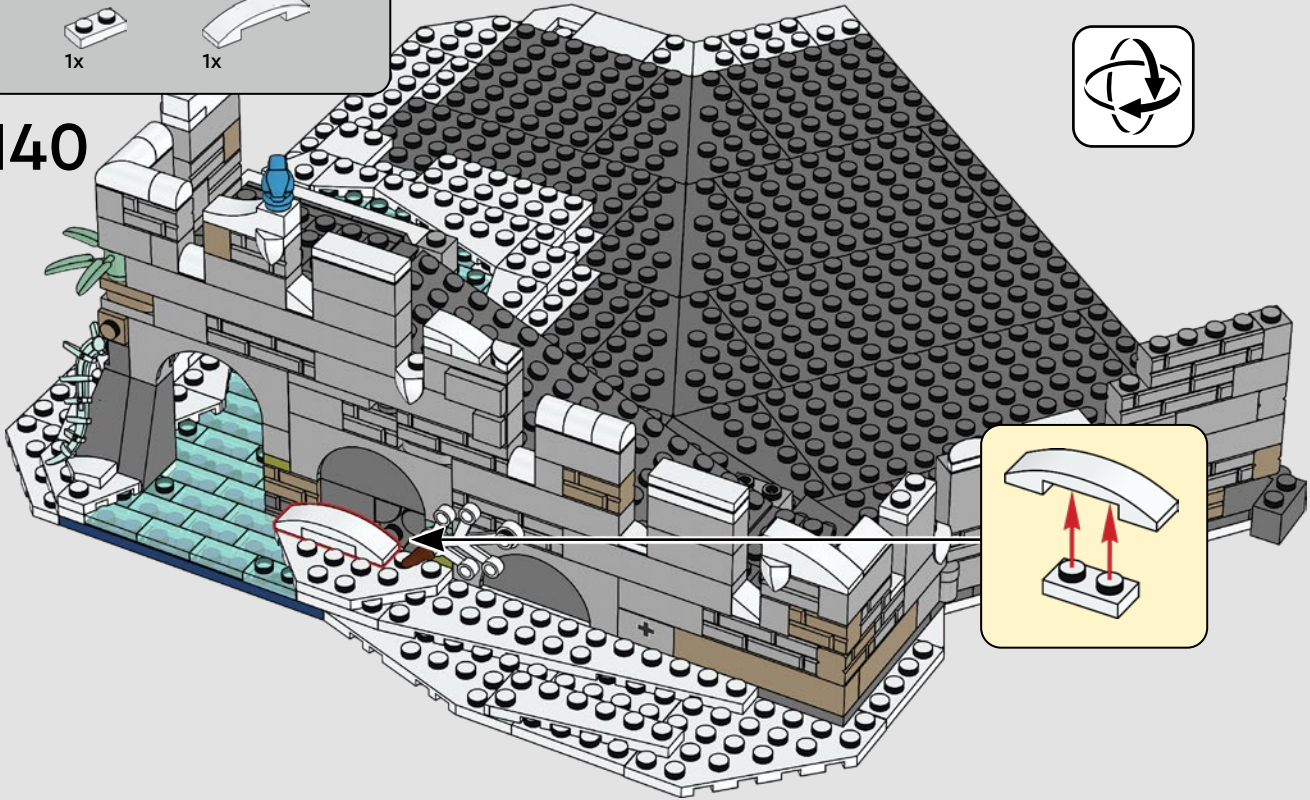

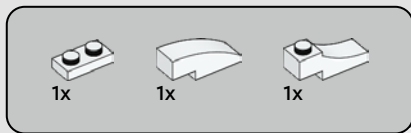

141

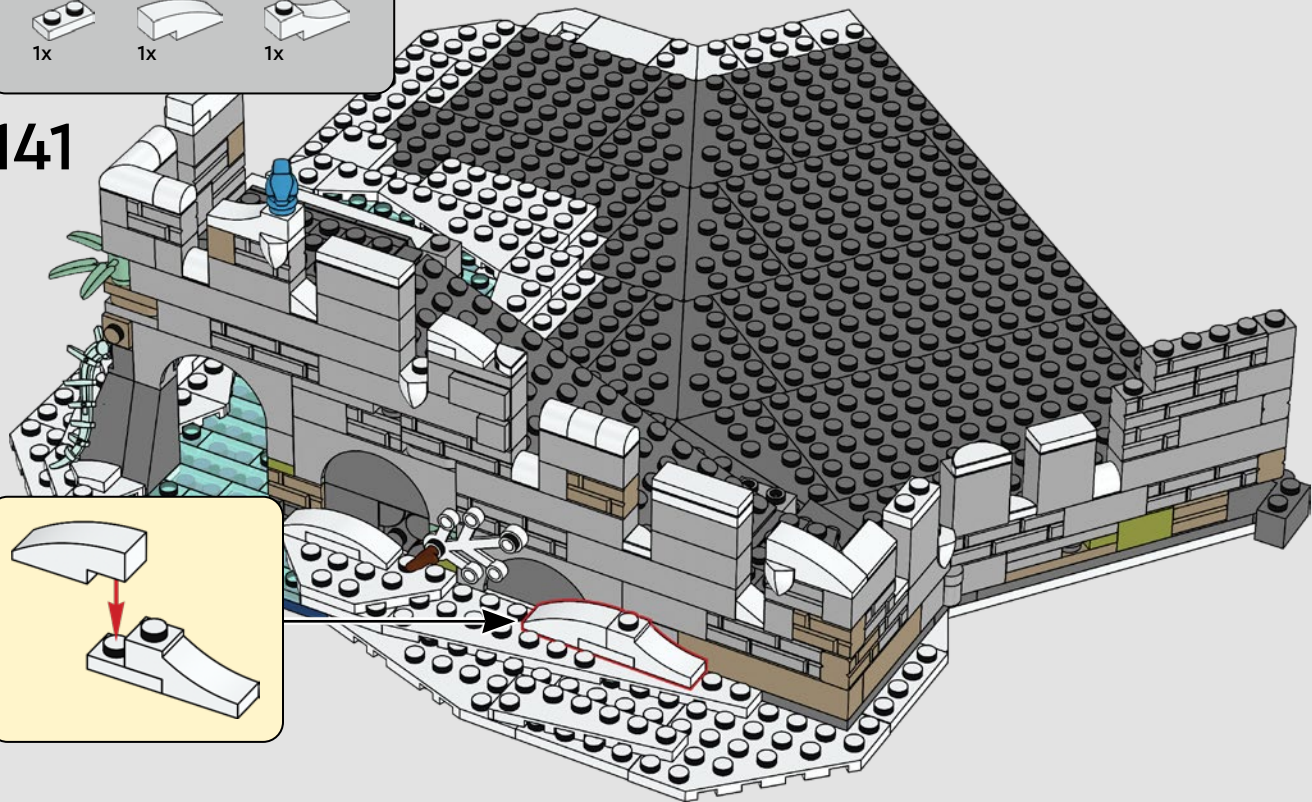
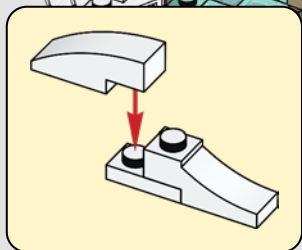

3x
2x
1x

142

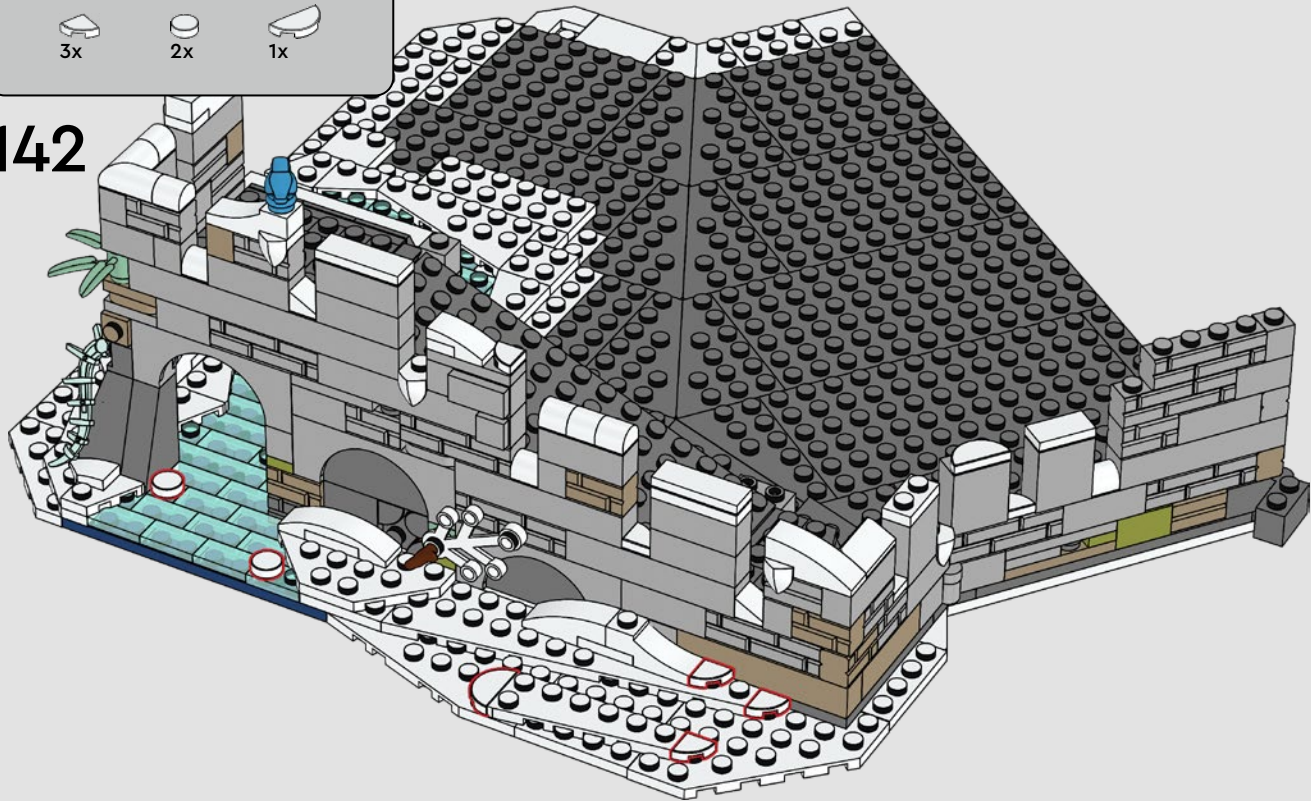





1x

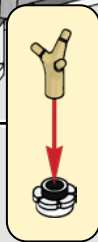
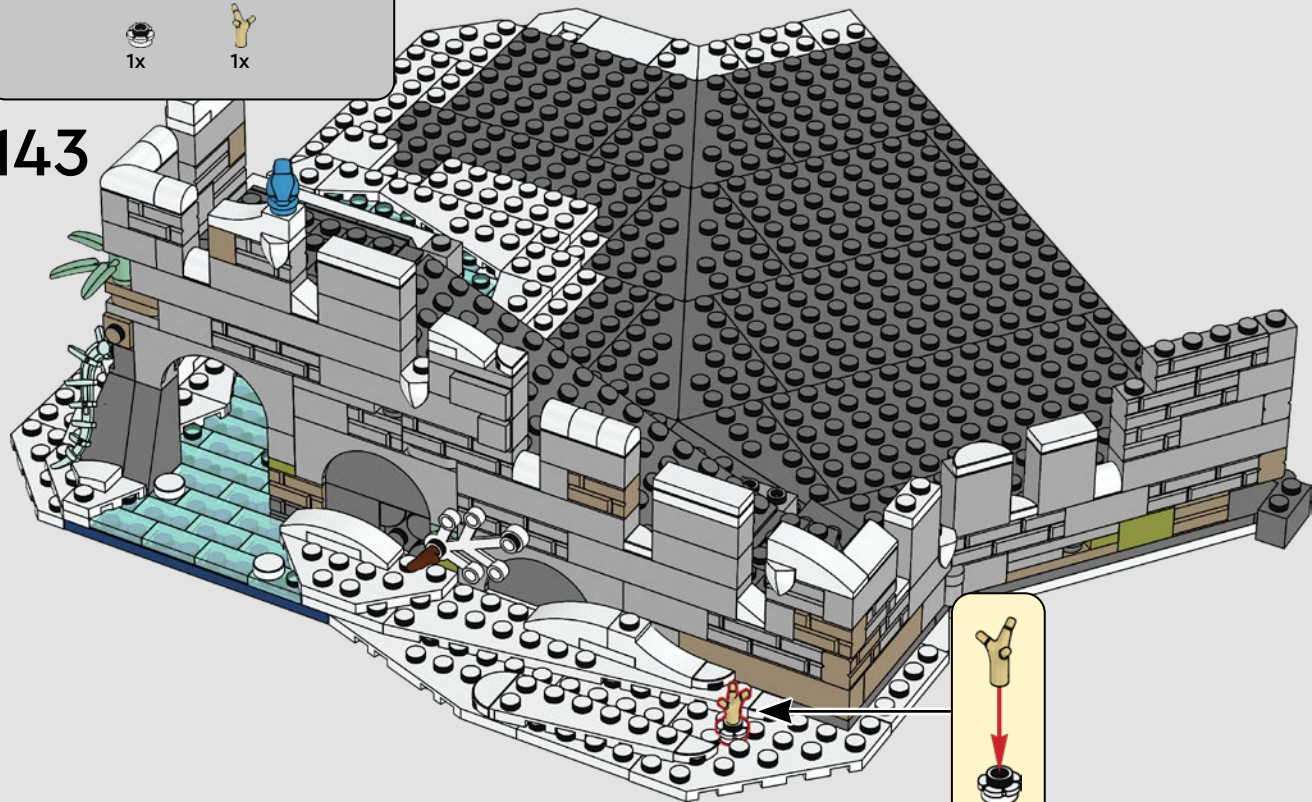

1x

143



1x  1x 

144

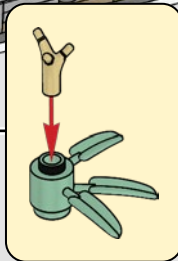
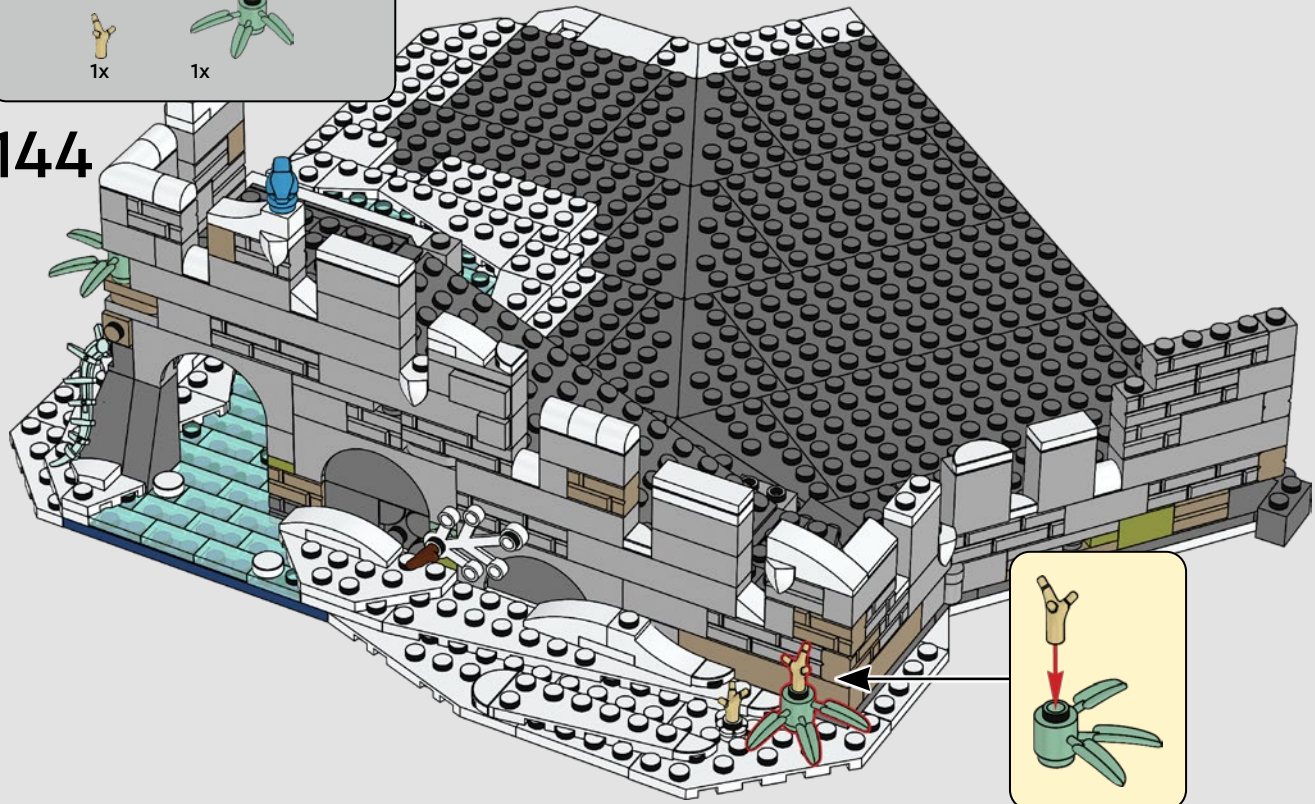

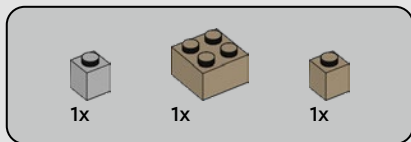

145



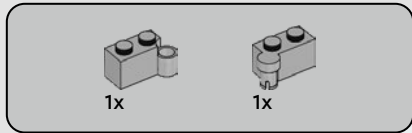

146

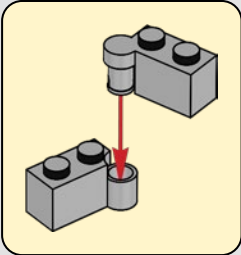

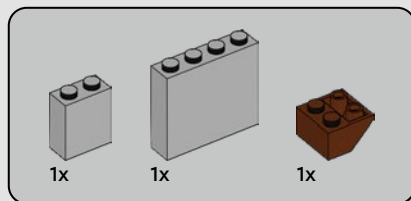

147

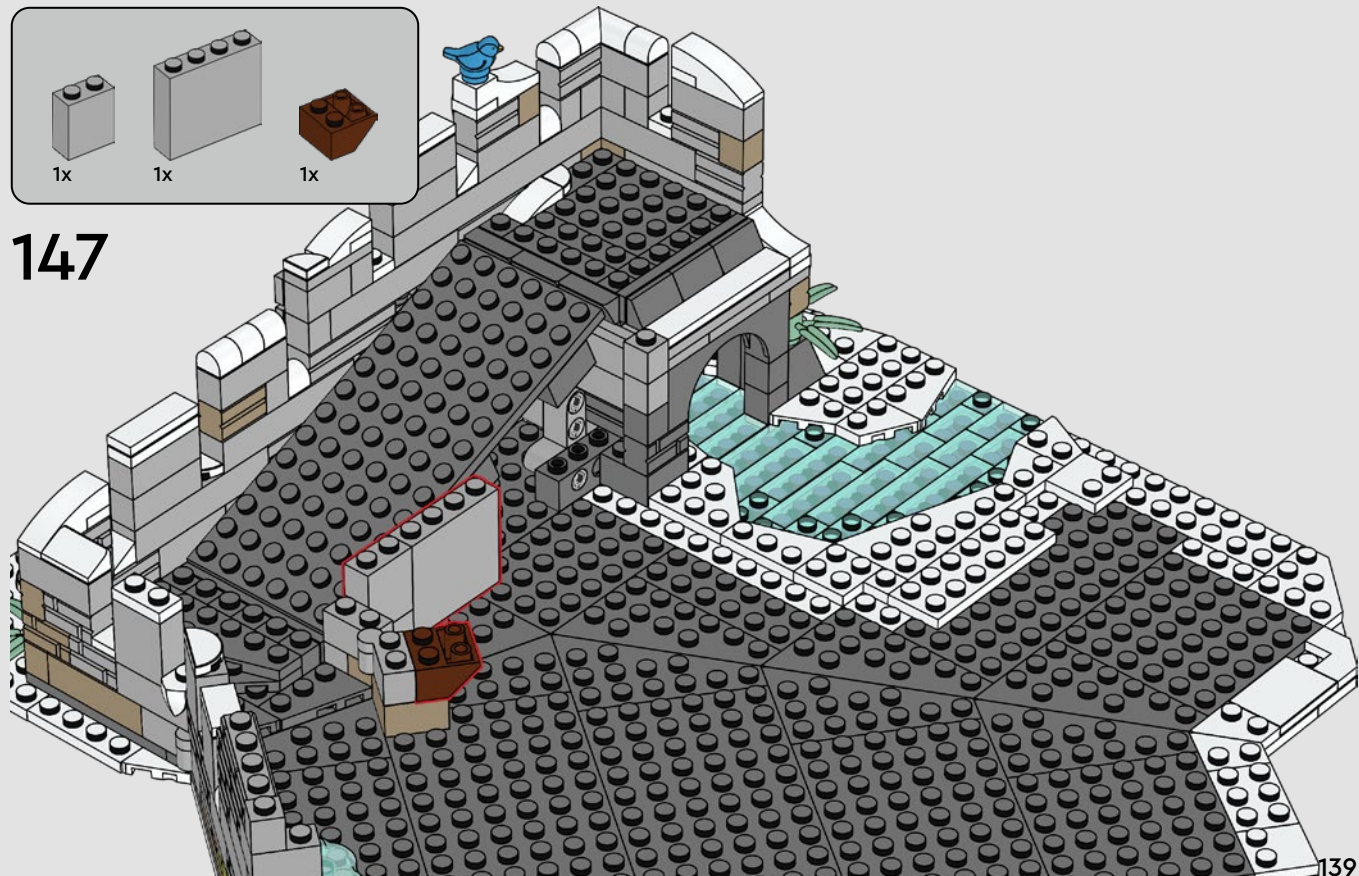

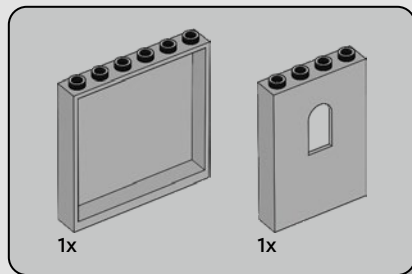

148

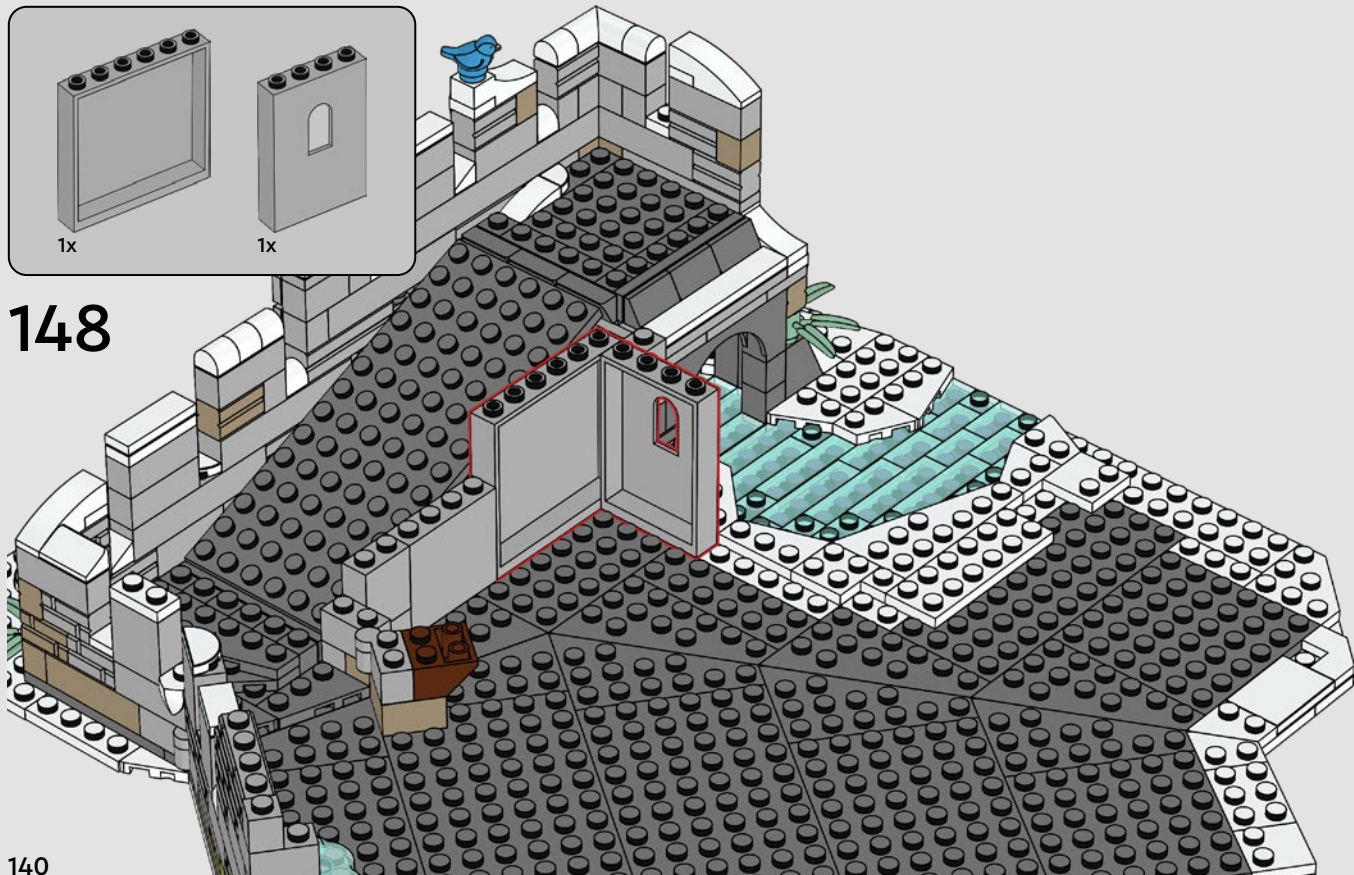

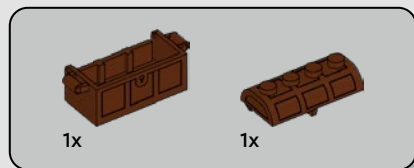

149

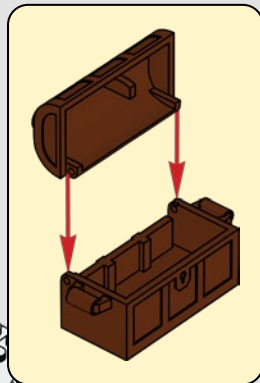
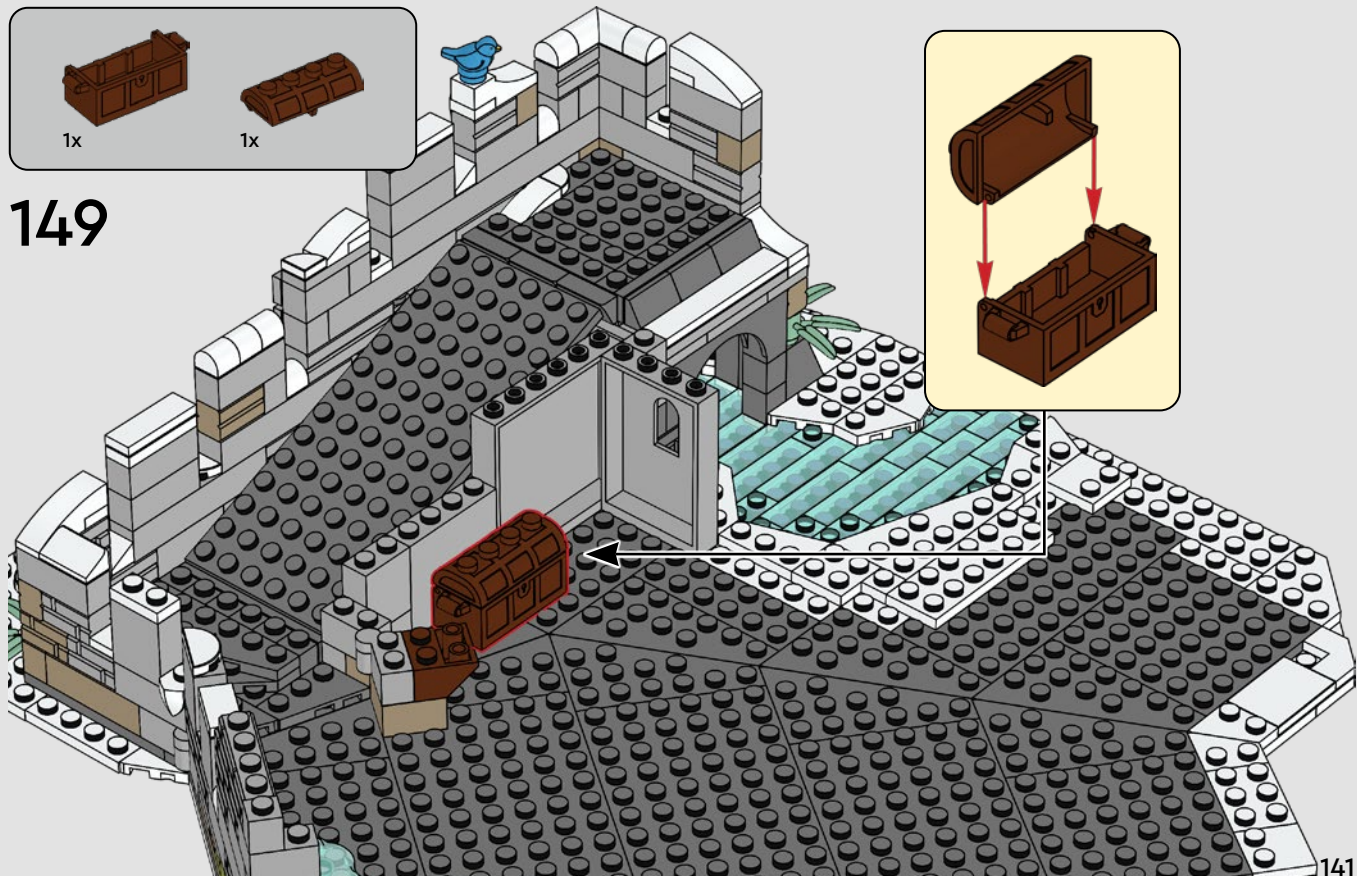

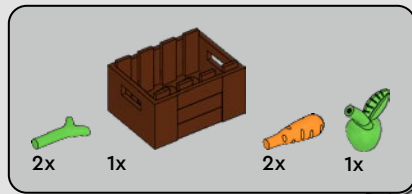

150

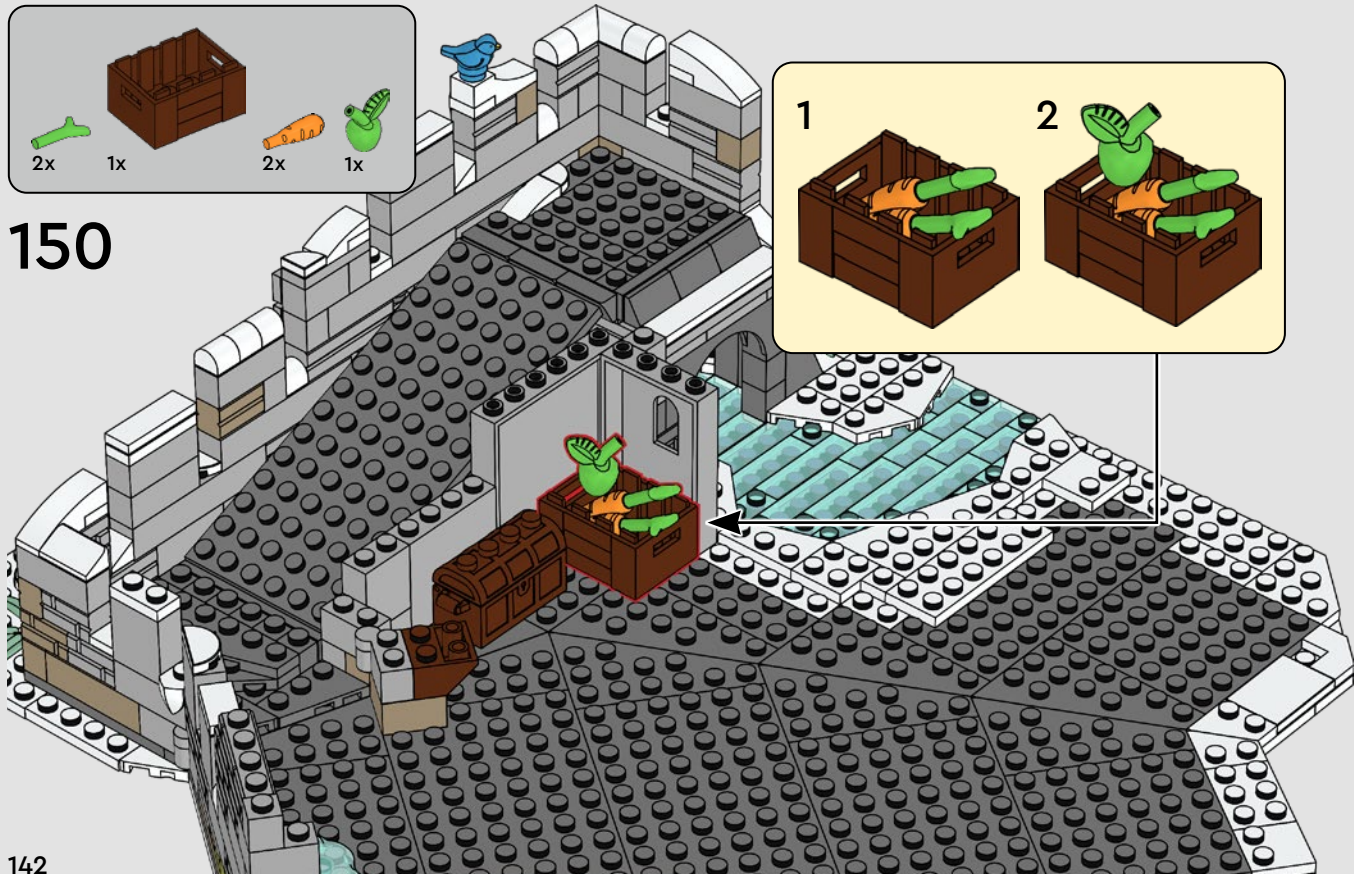
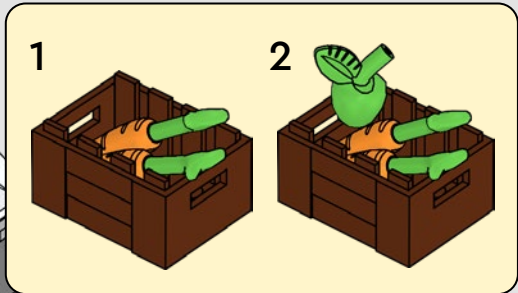

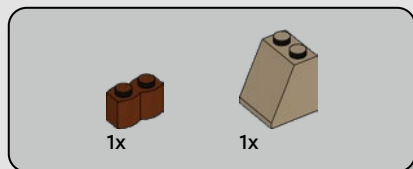

151



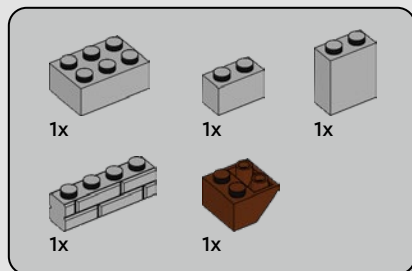

152





1x



1x

153

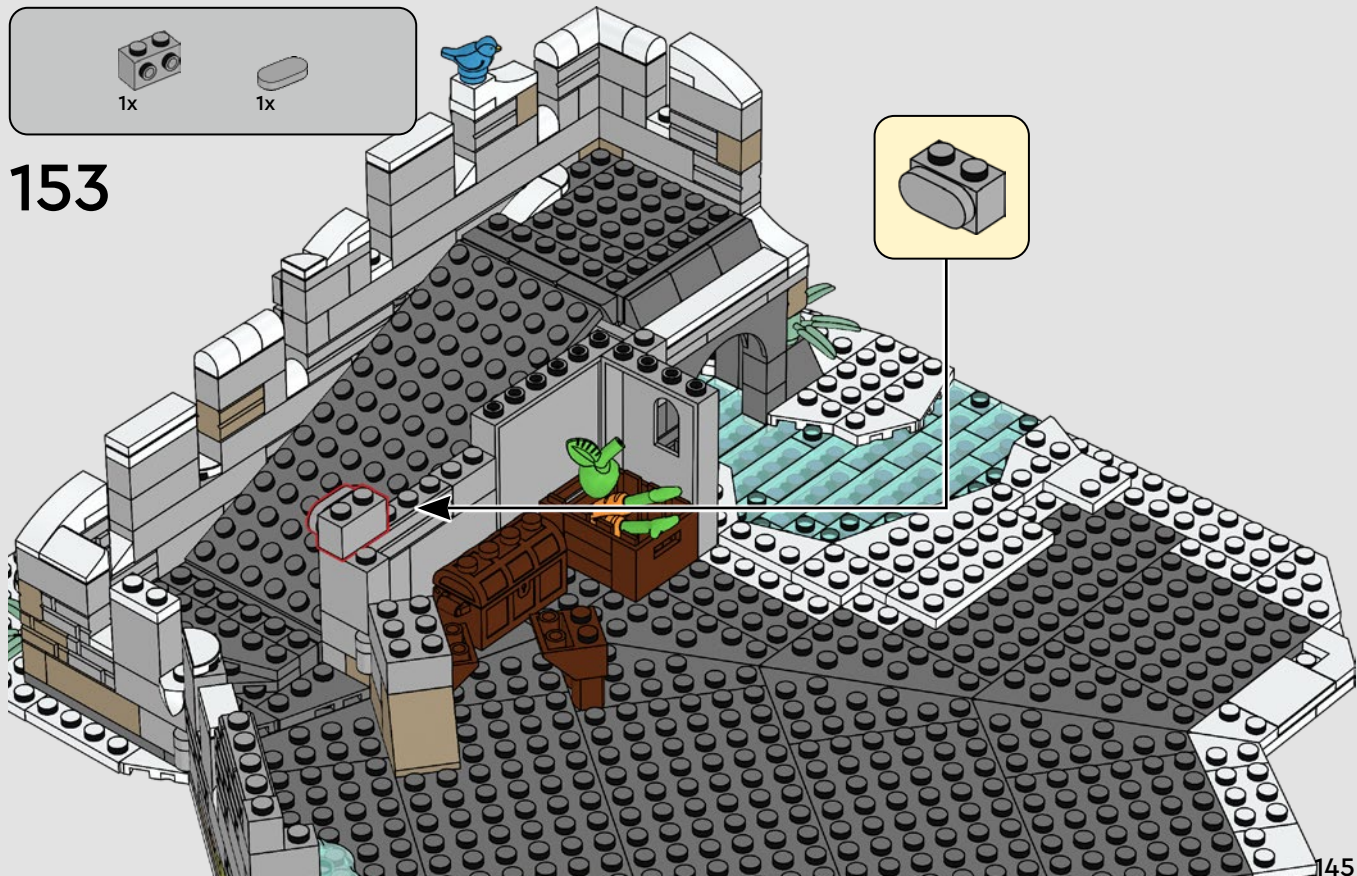
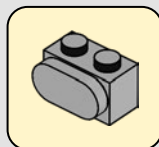

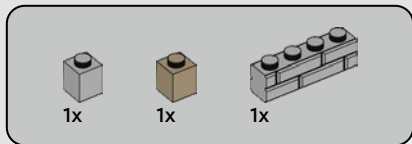

154

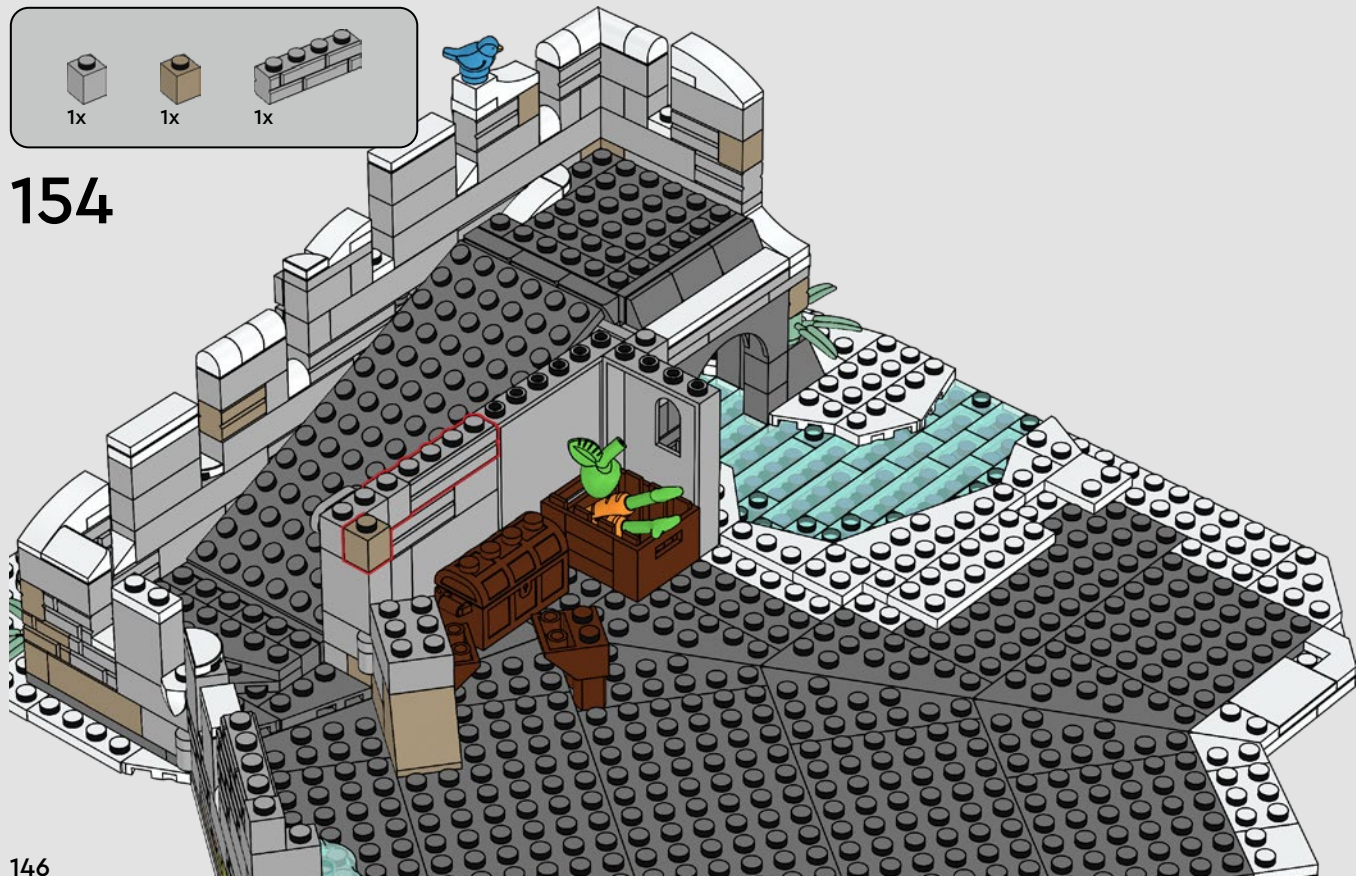



2x

155

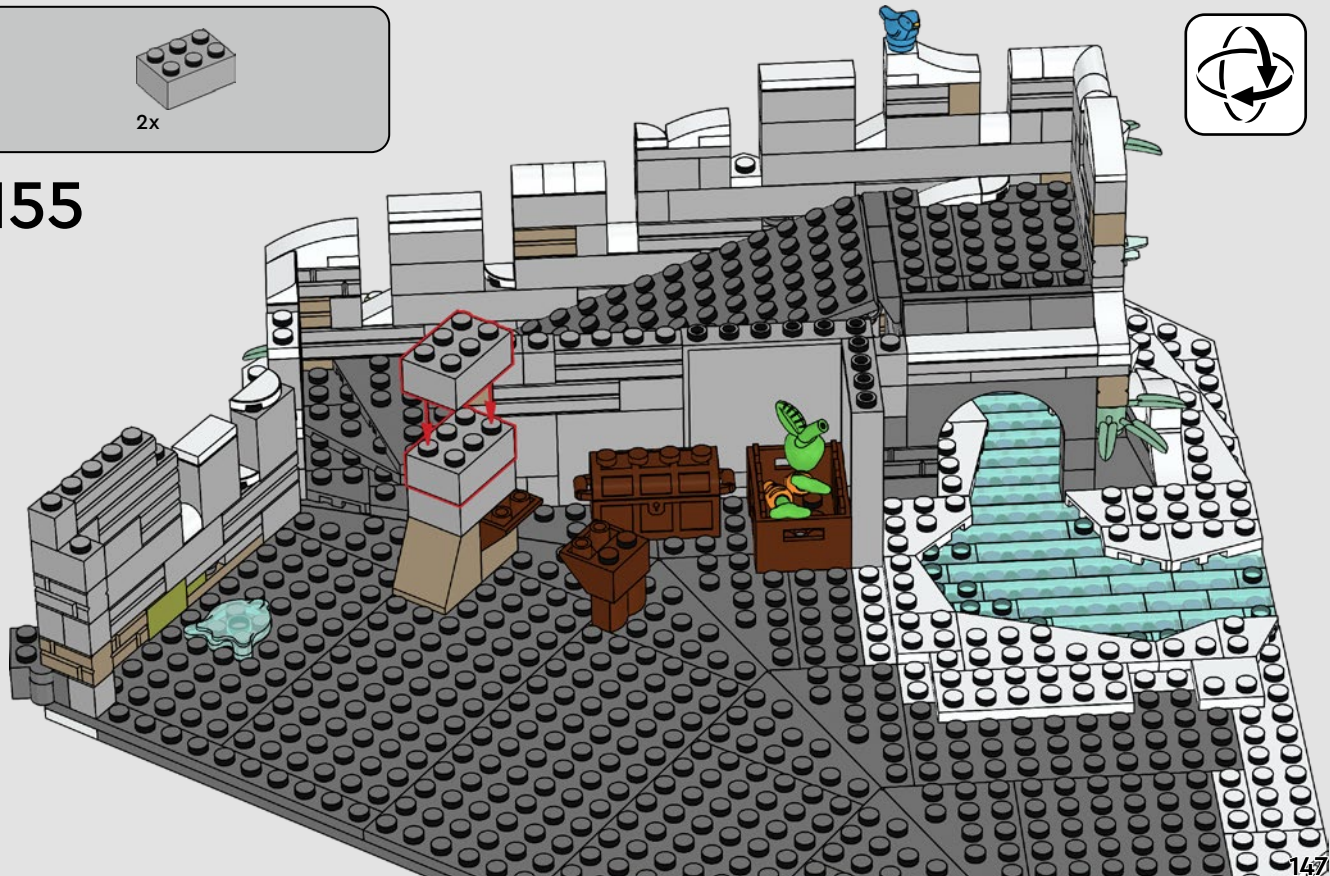



156

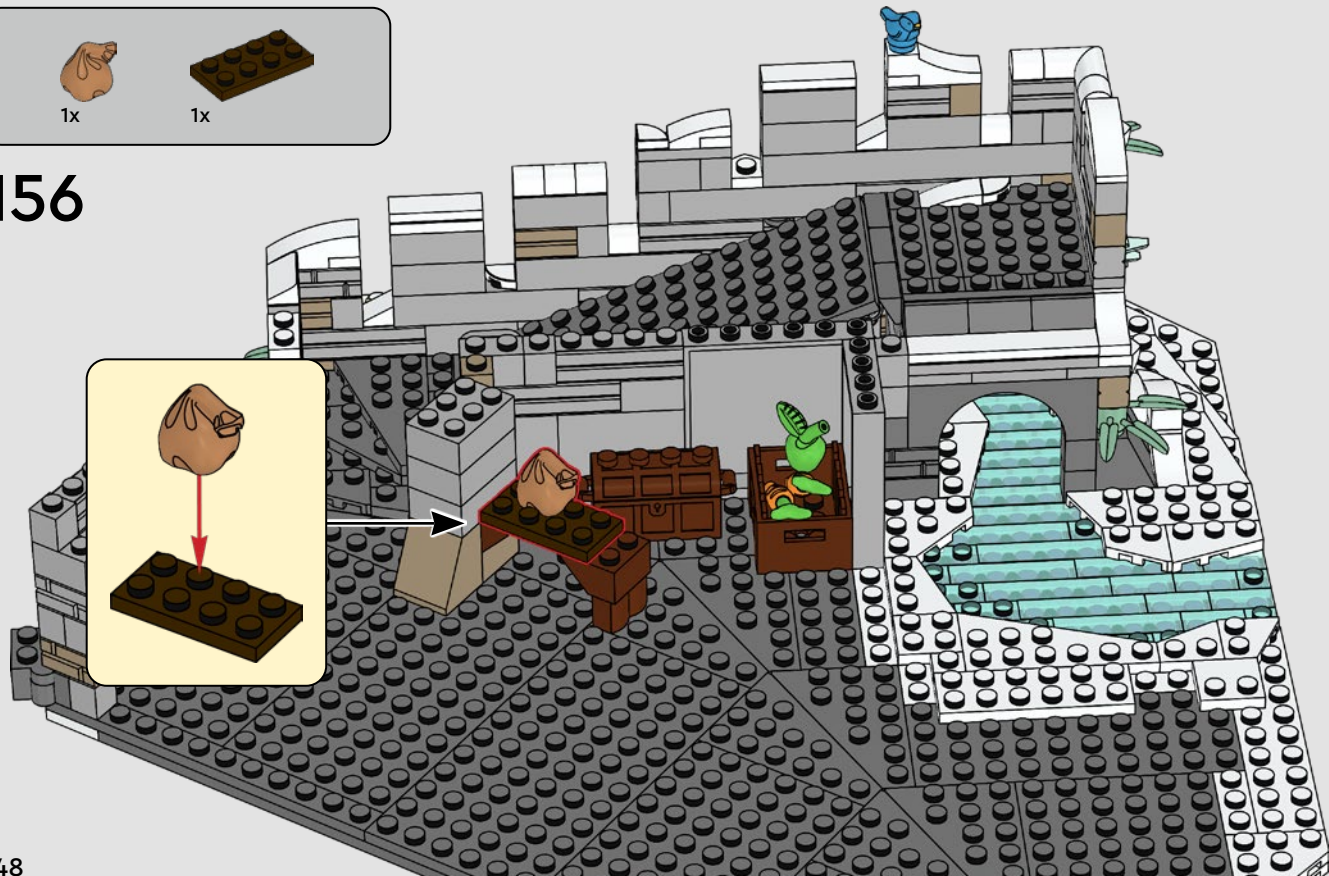



3x

157

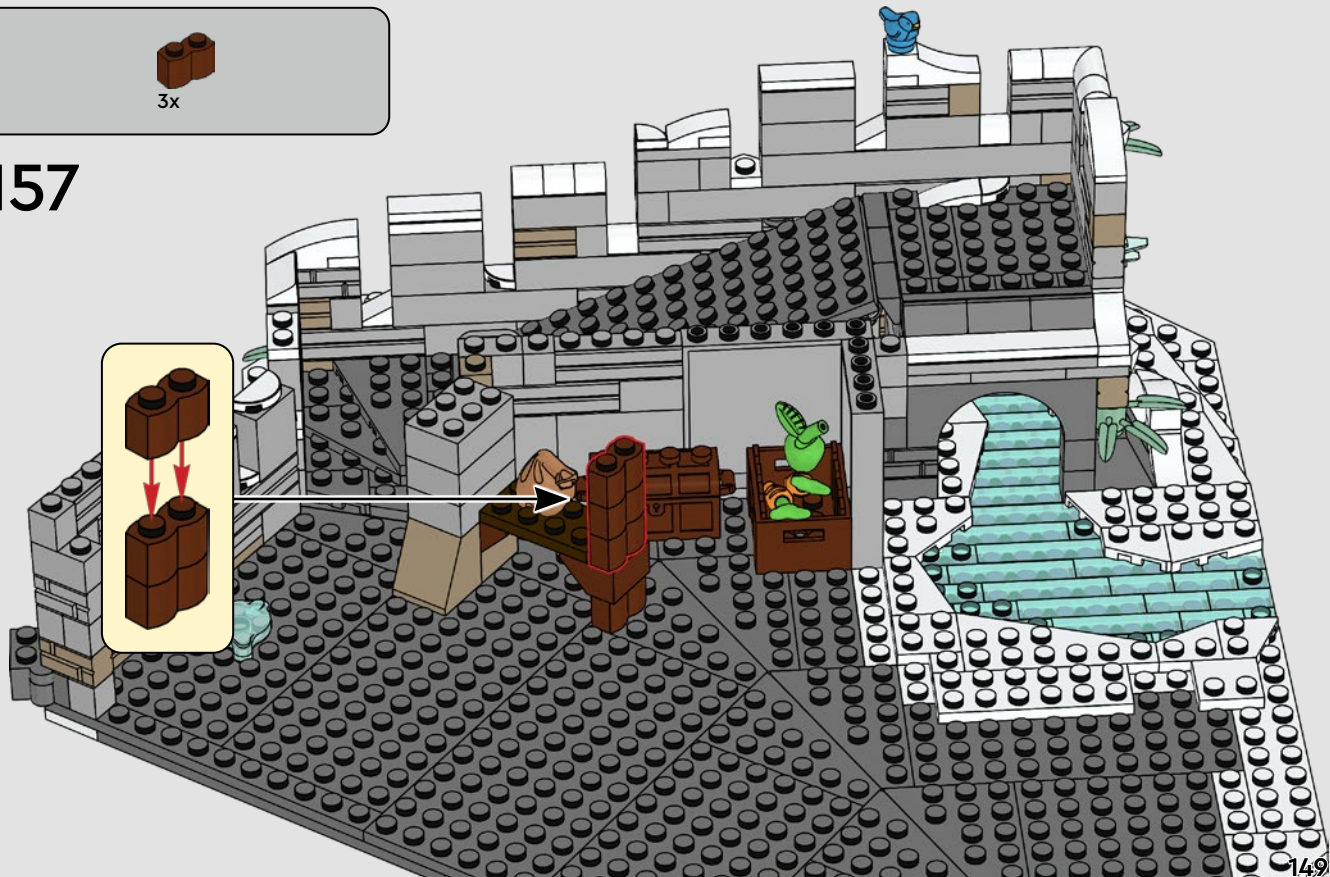



158

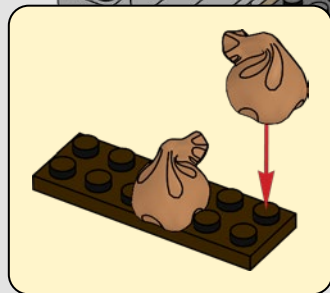

150

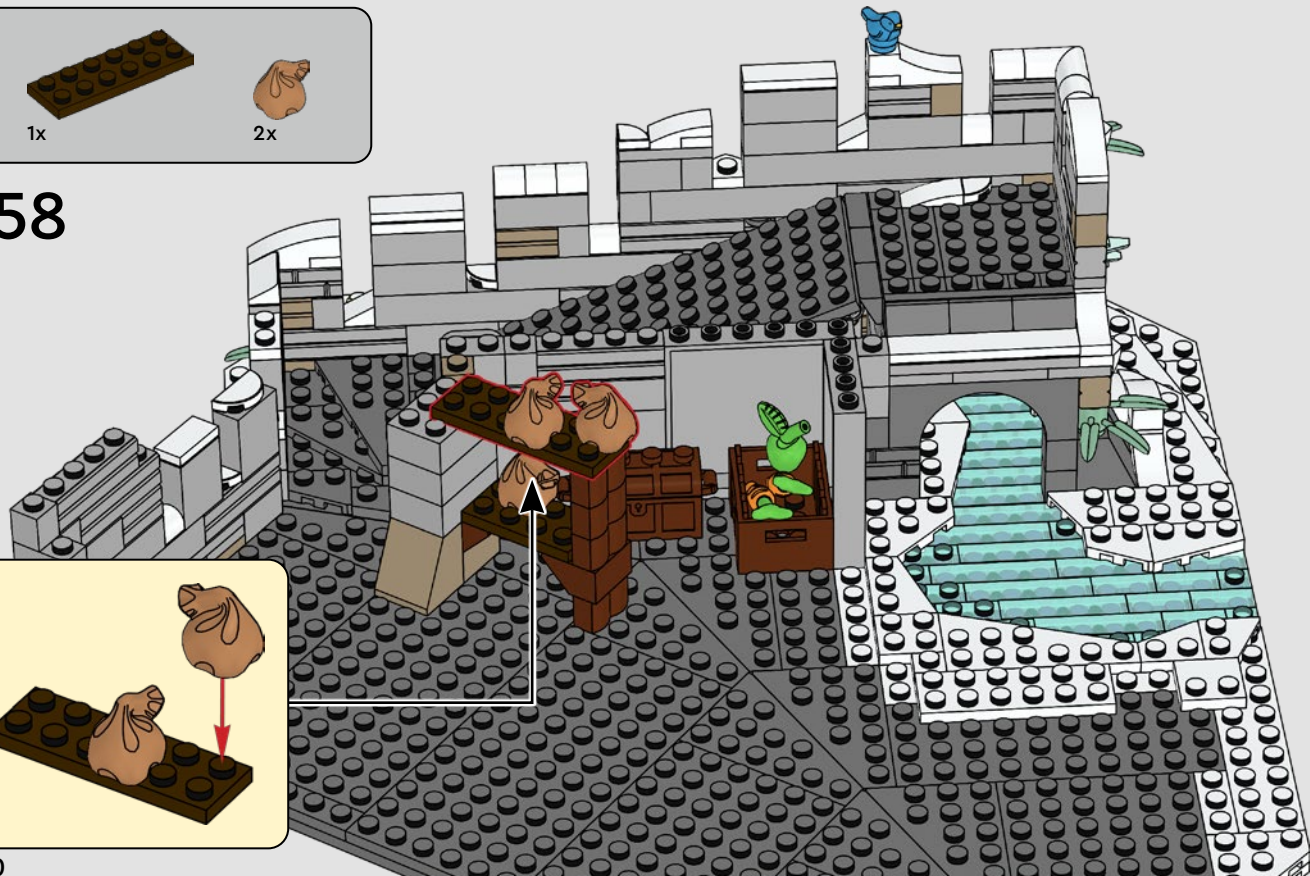

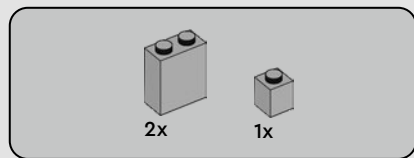

159

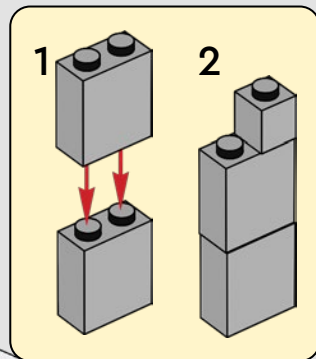

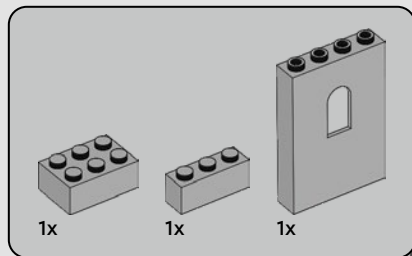

160



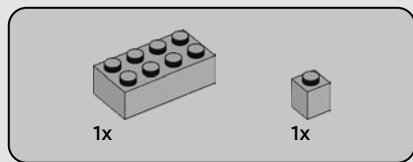

161



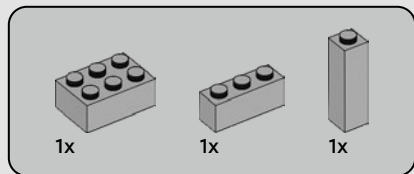

162



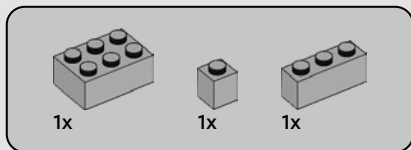

163



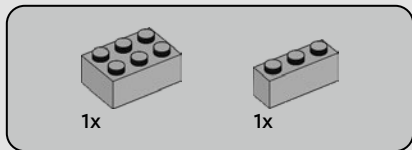

164





165





166



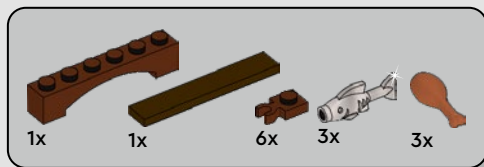

167

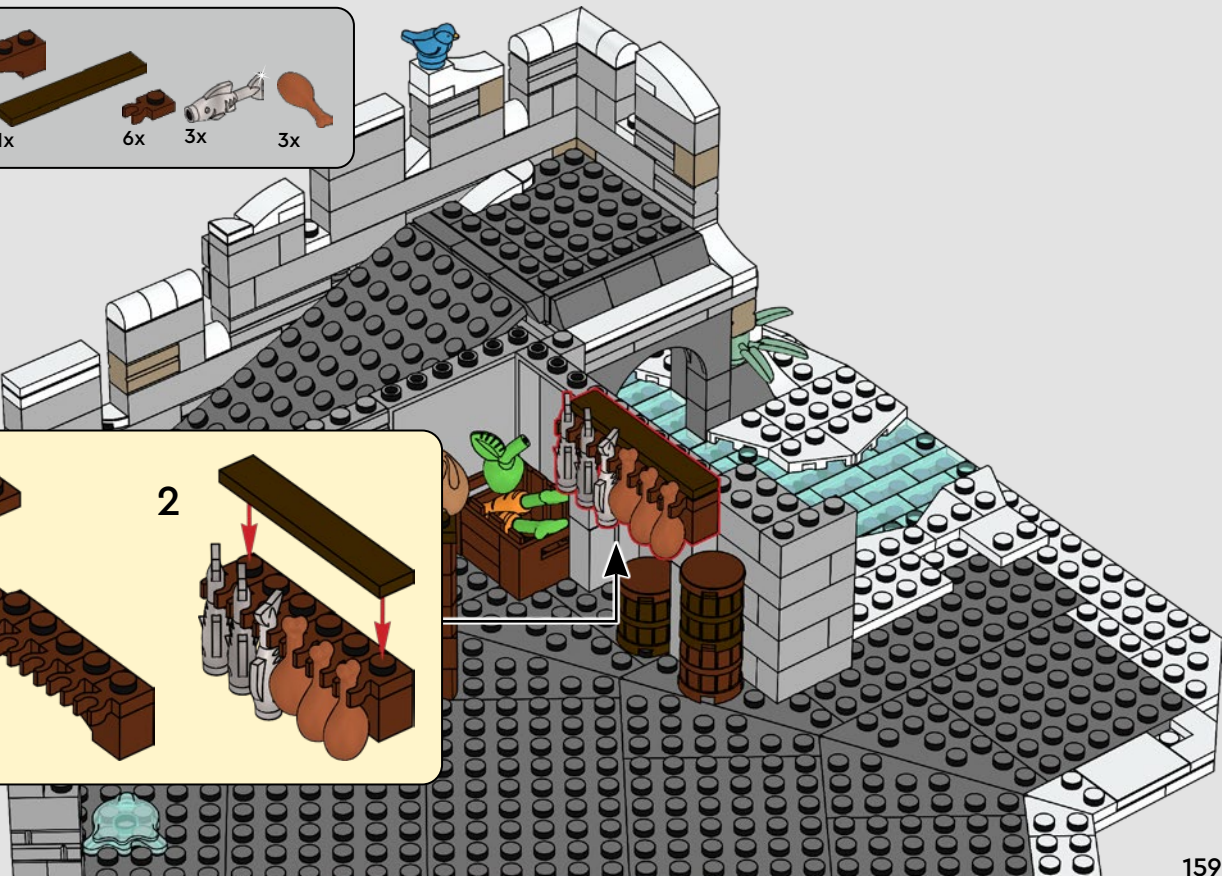
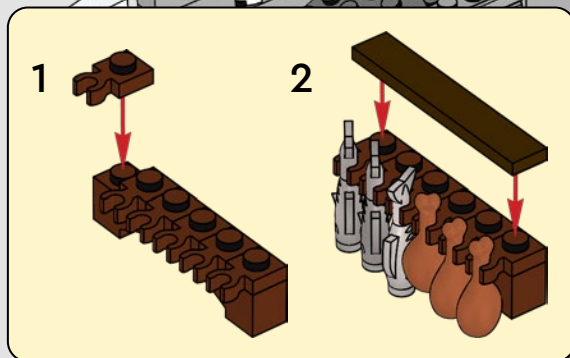

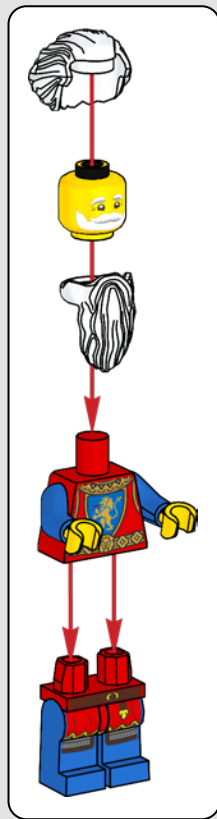



168

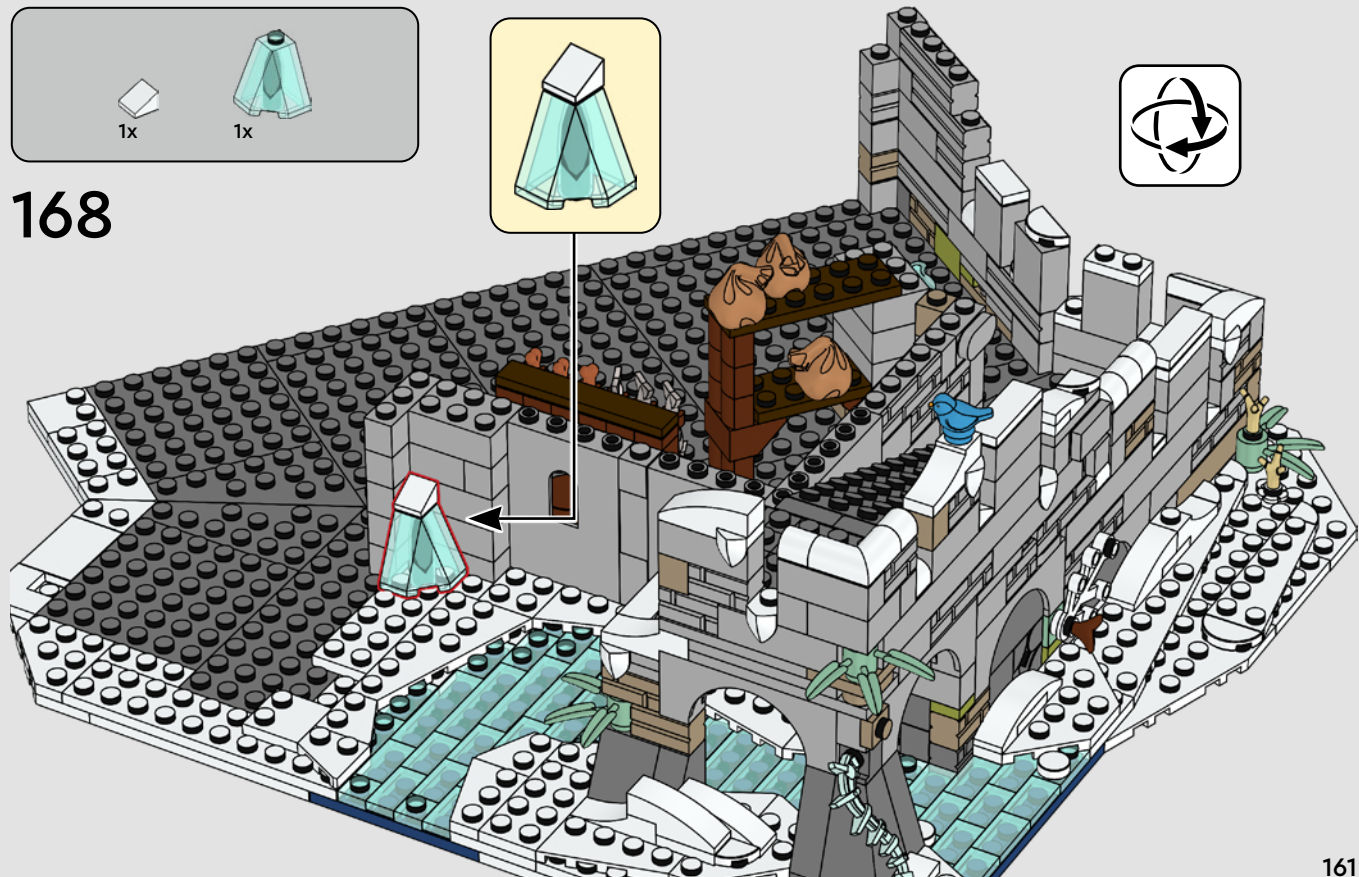

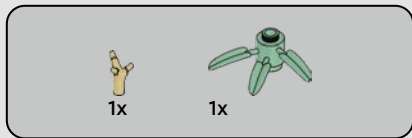

169

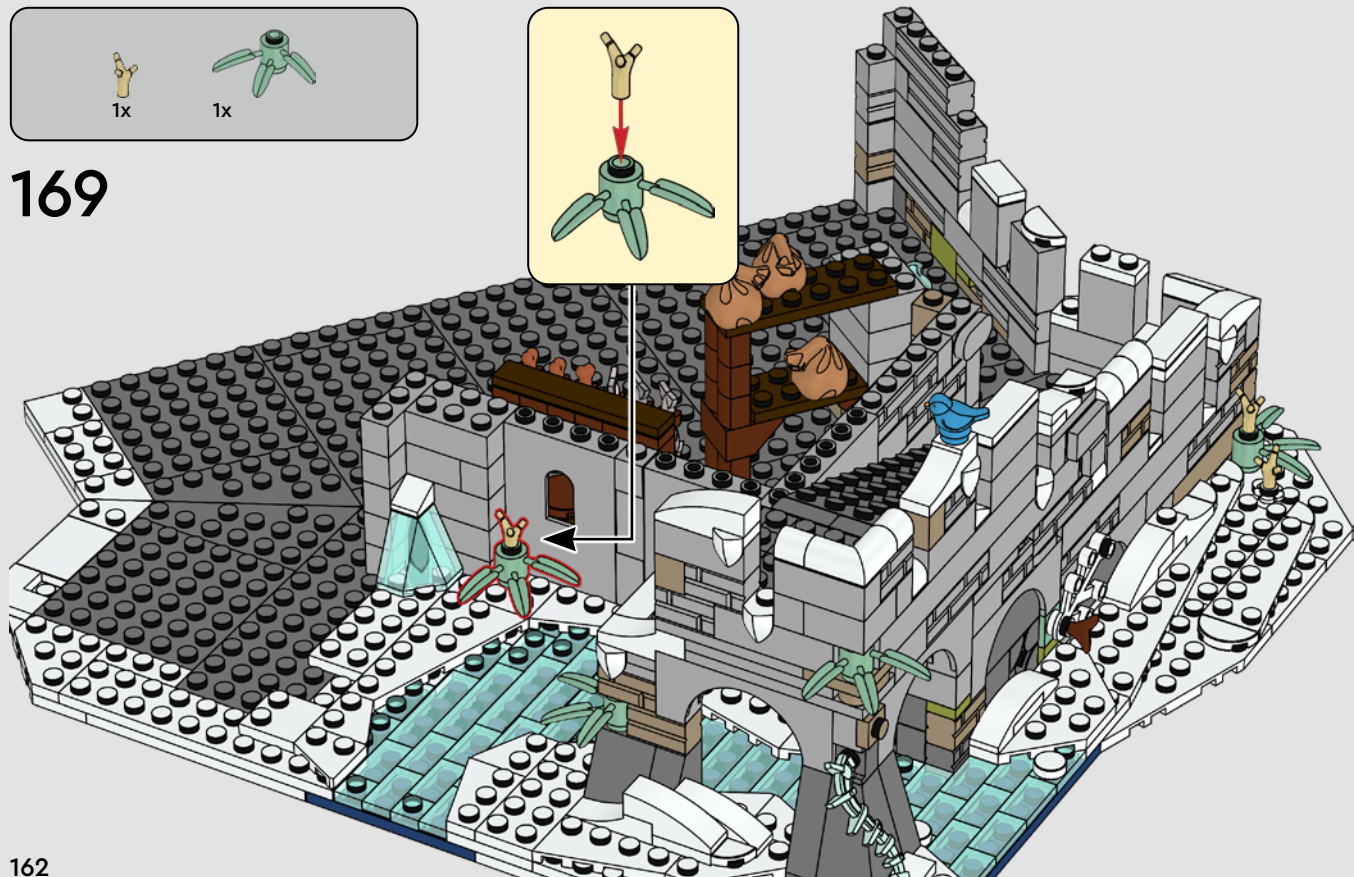
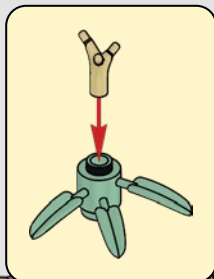

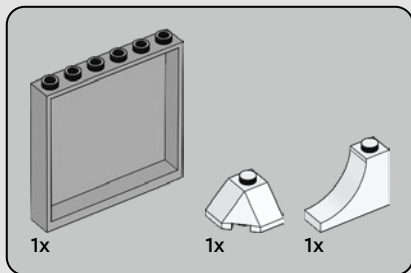

170

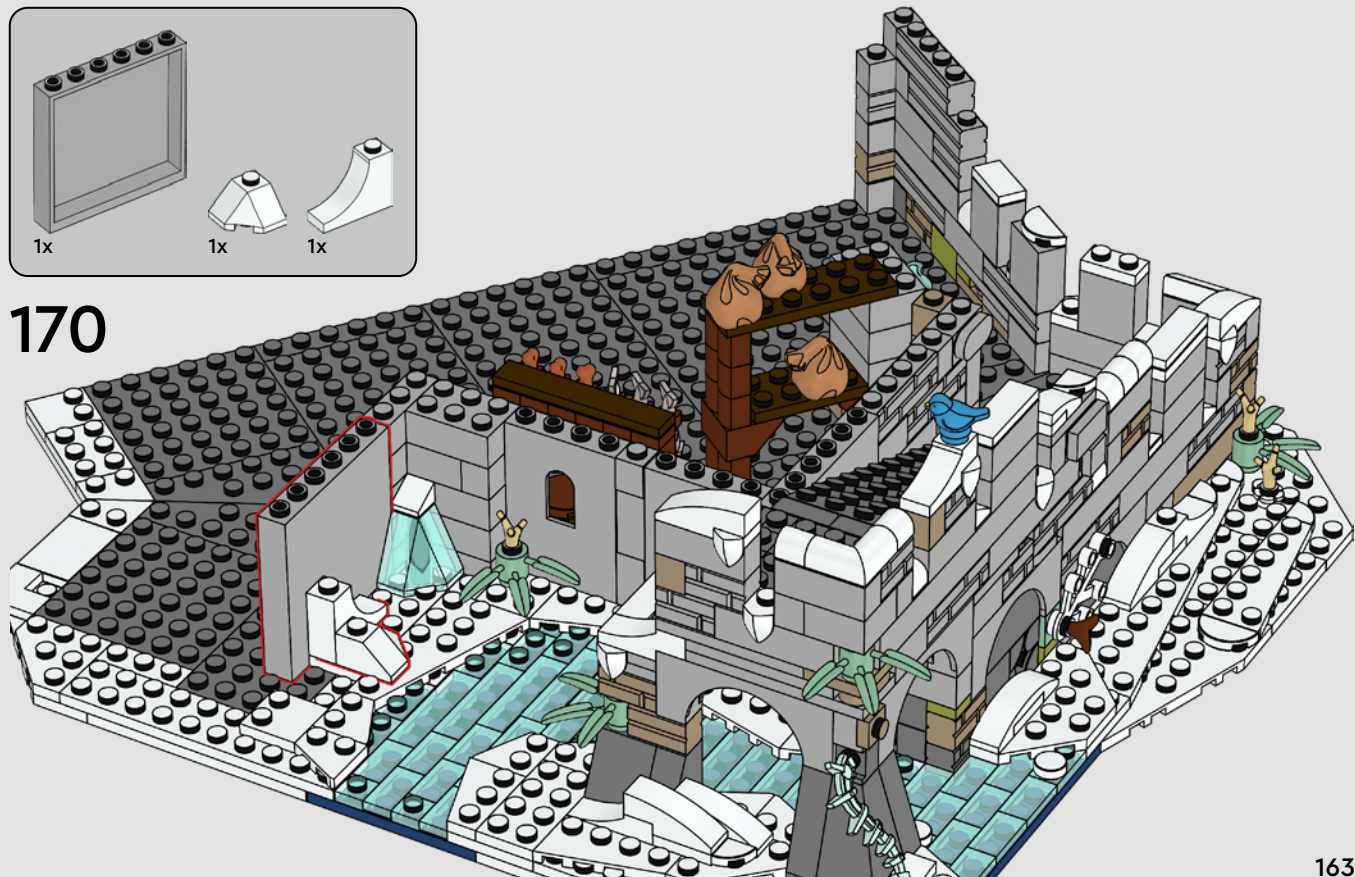



1x



1x

171





1x



1x



172

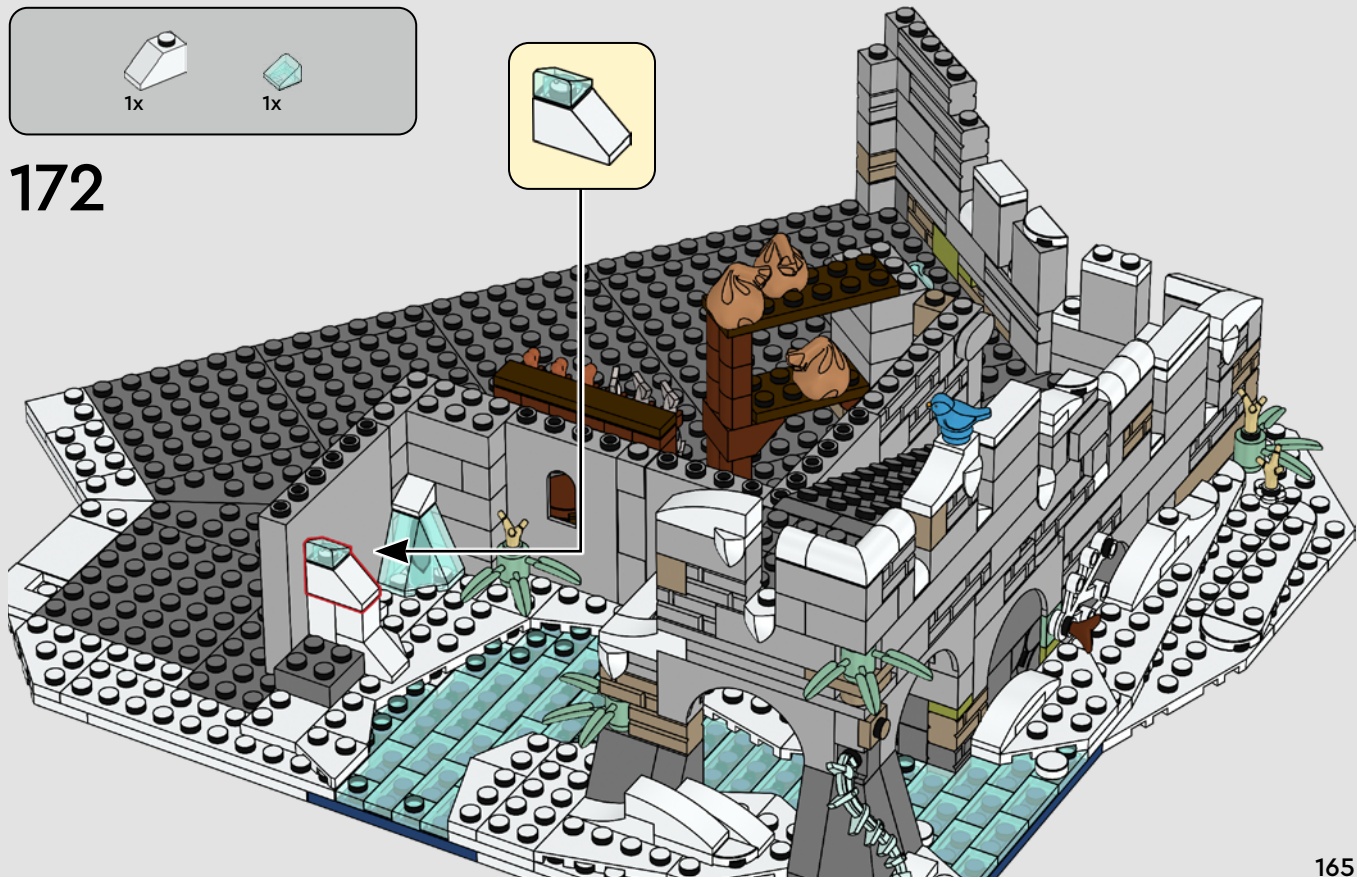

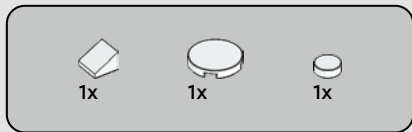

173



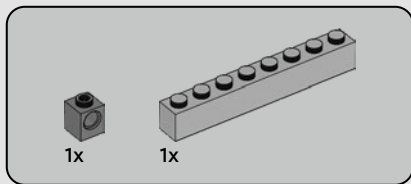

174



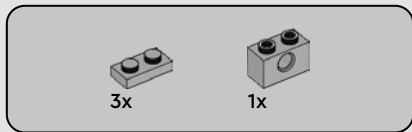

175

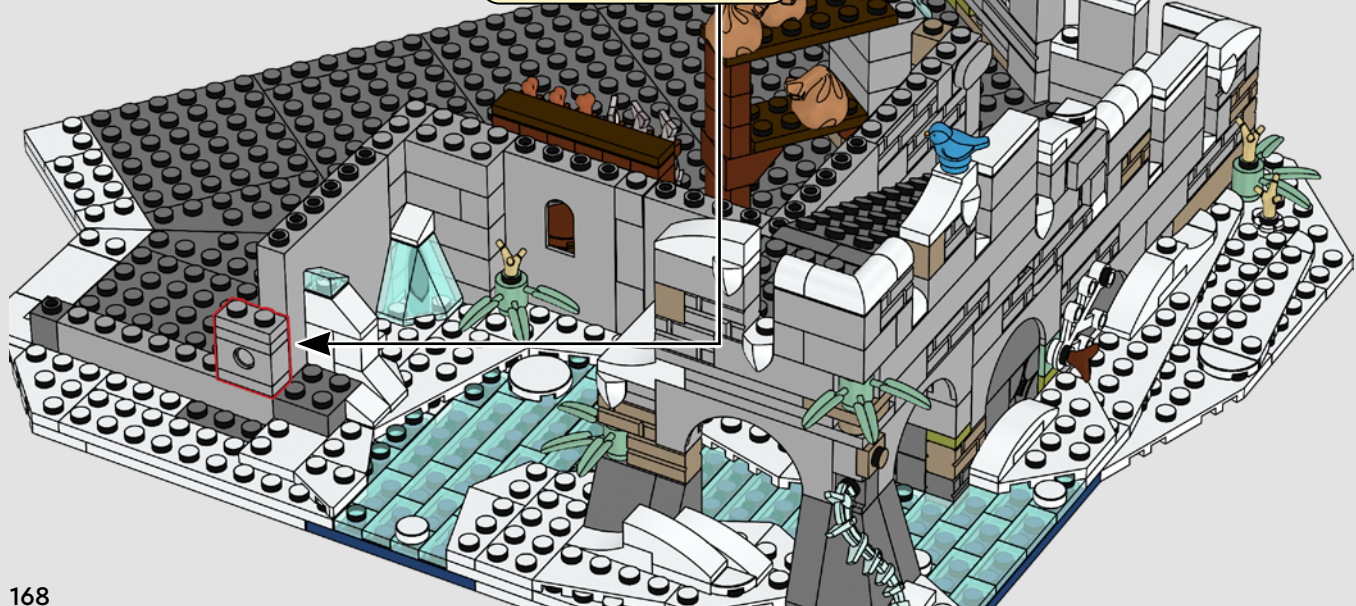
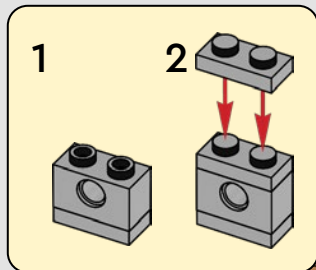

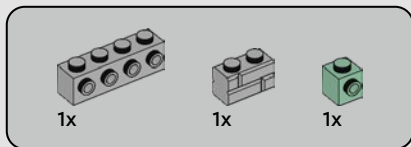

176



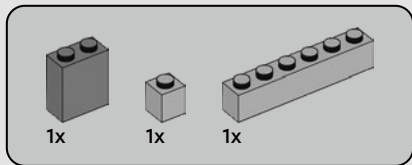

177

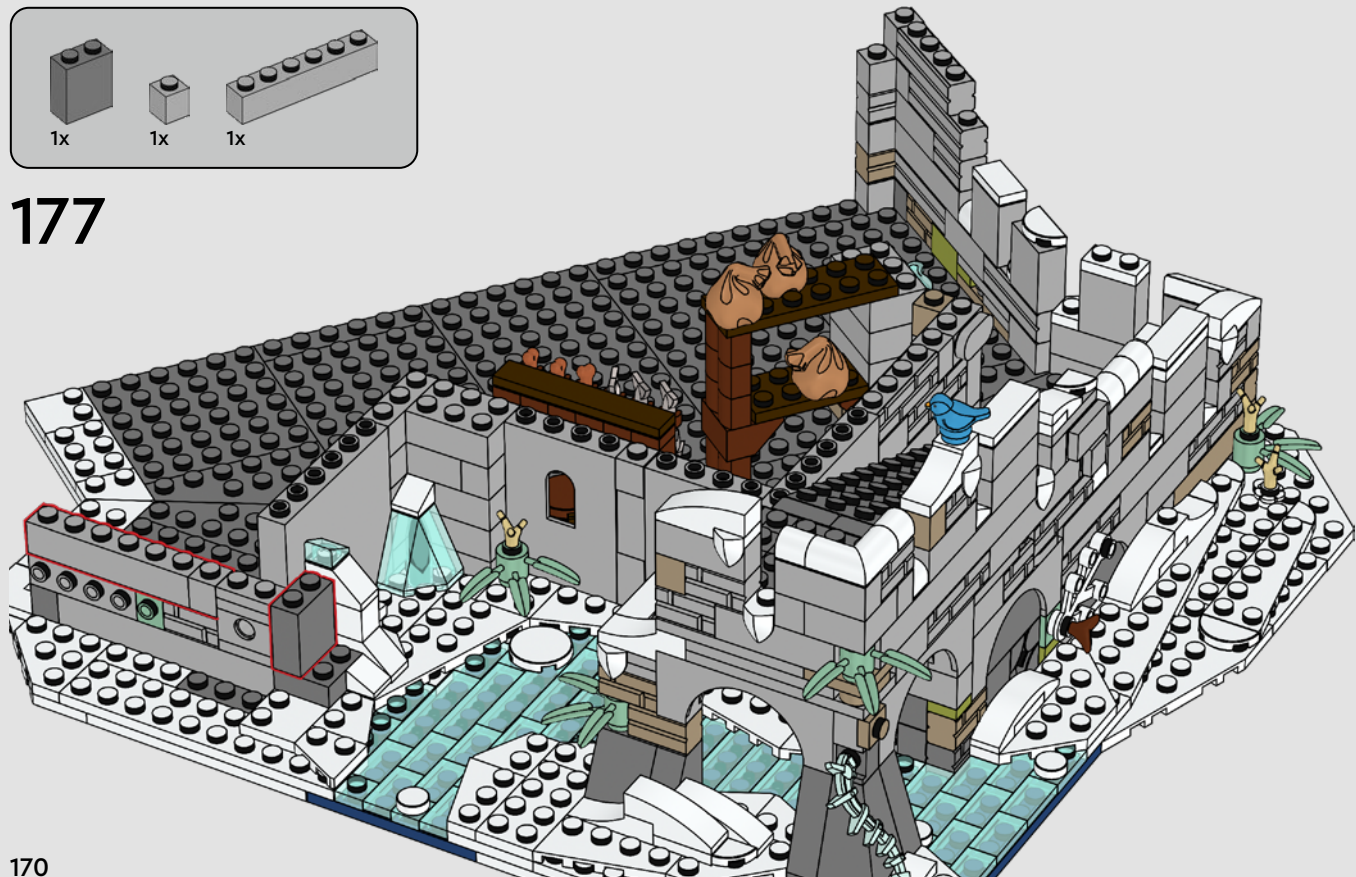

170

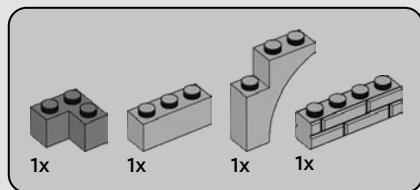

178

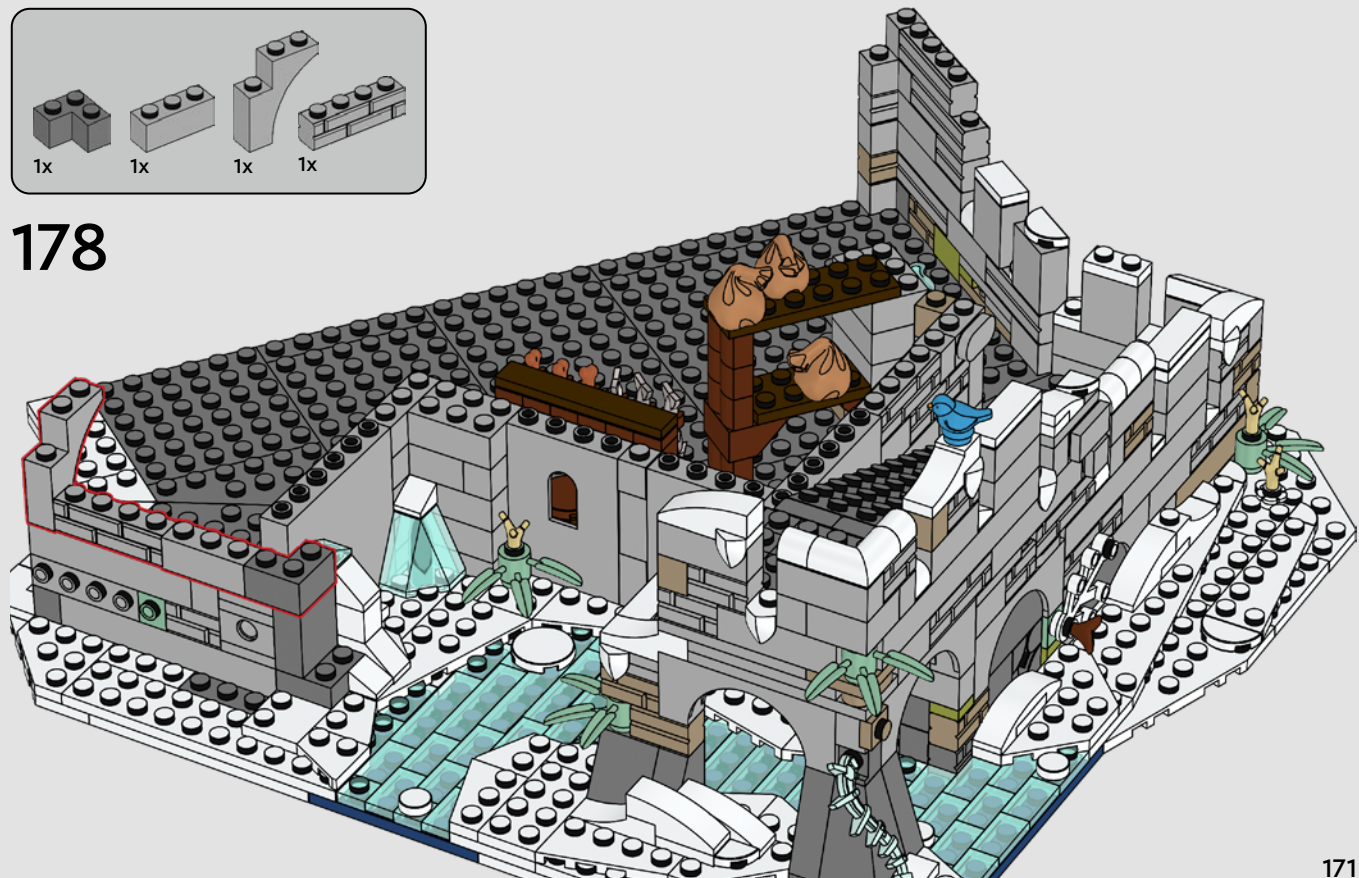



2x

179



172

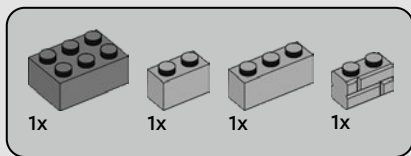

180





2x

181

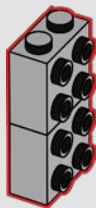

1x



1x

182

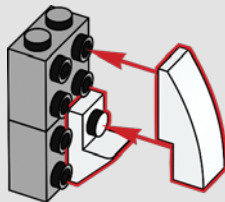



1x



1x



1x

183

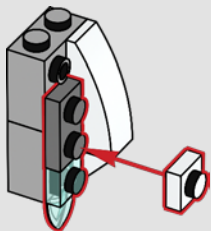

1x



1x

184

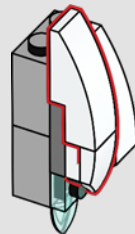

185

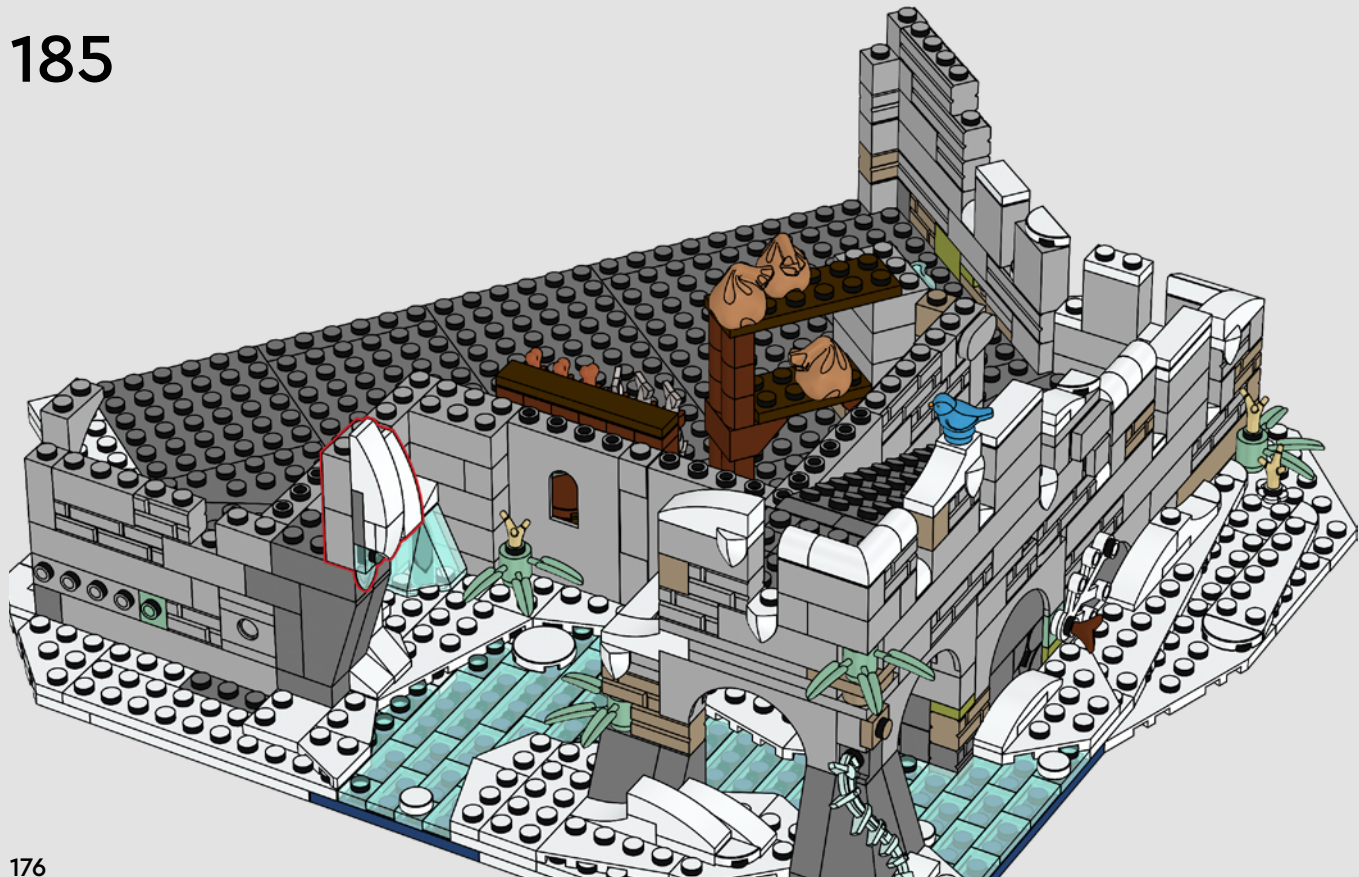

176

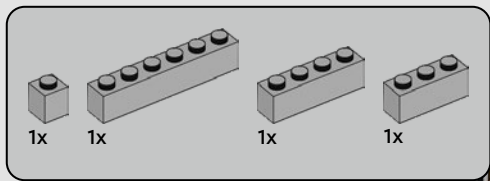

186



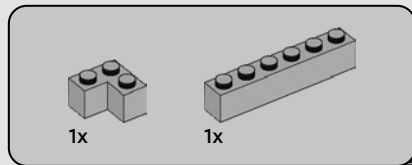

187

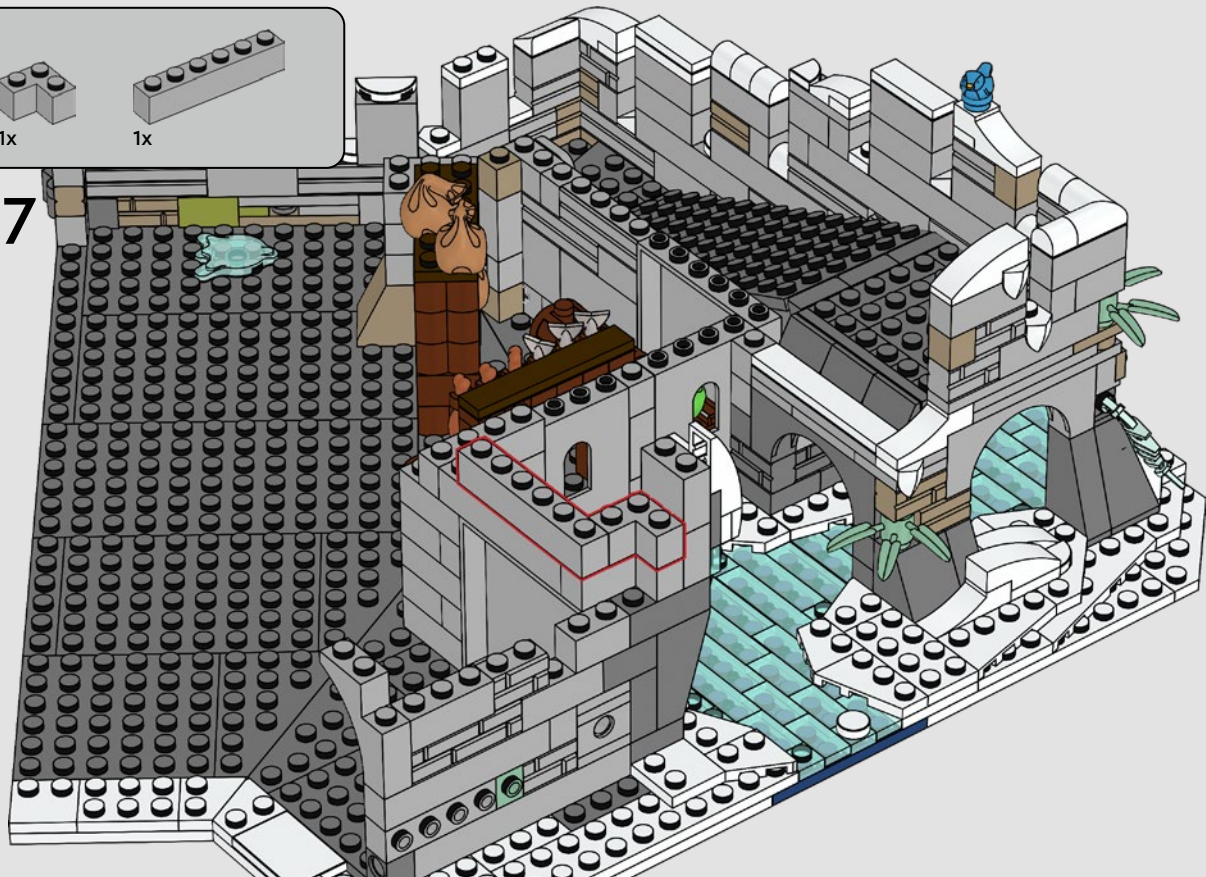

178

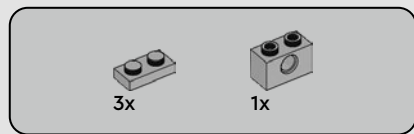

188

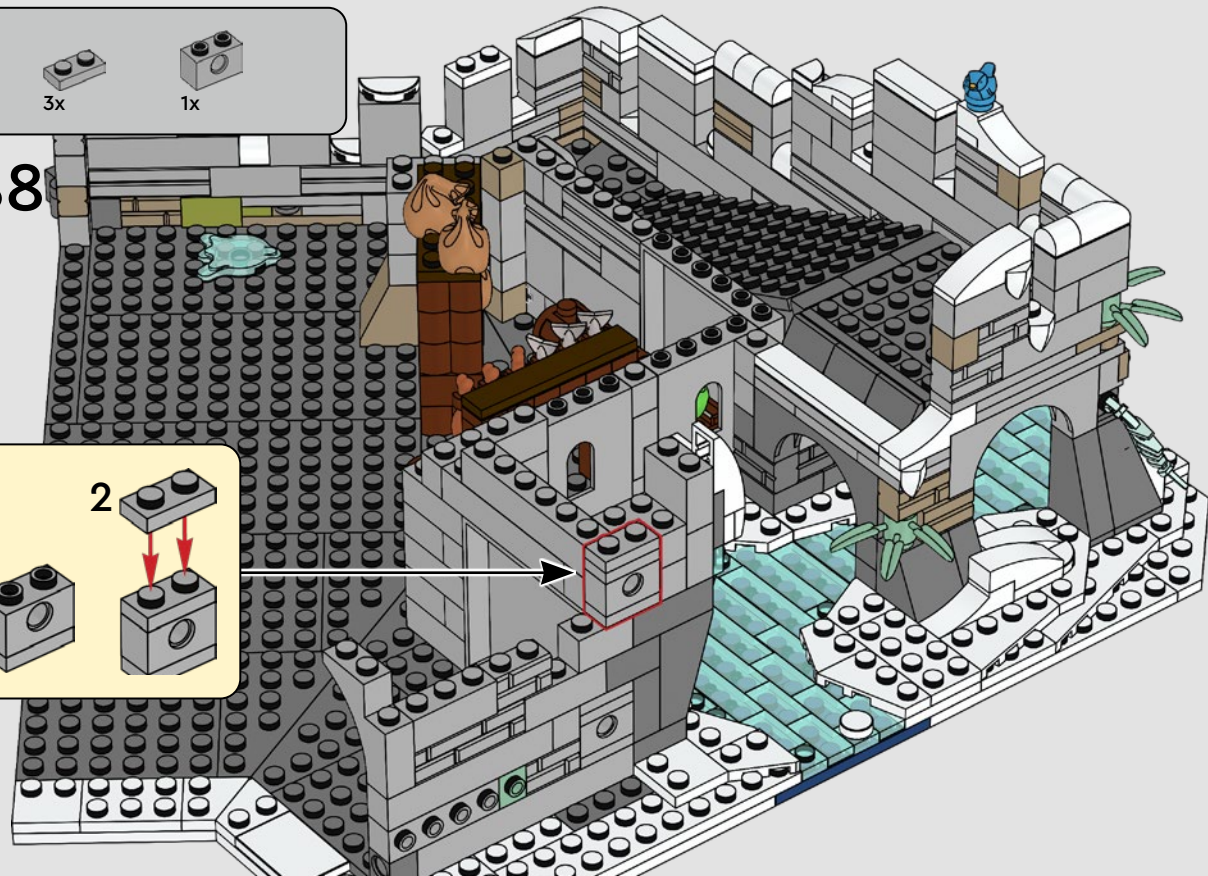
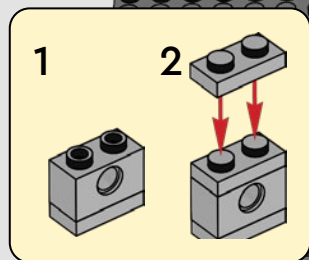

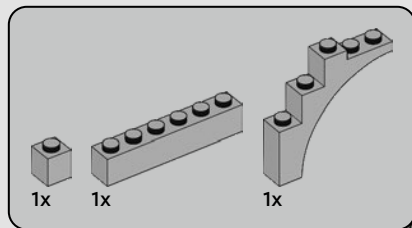

189

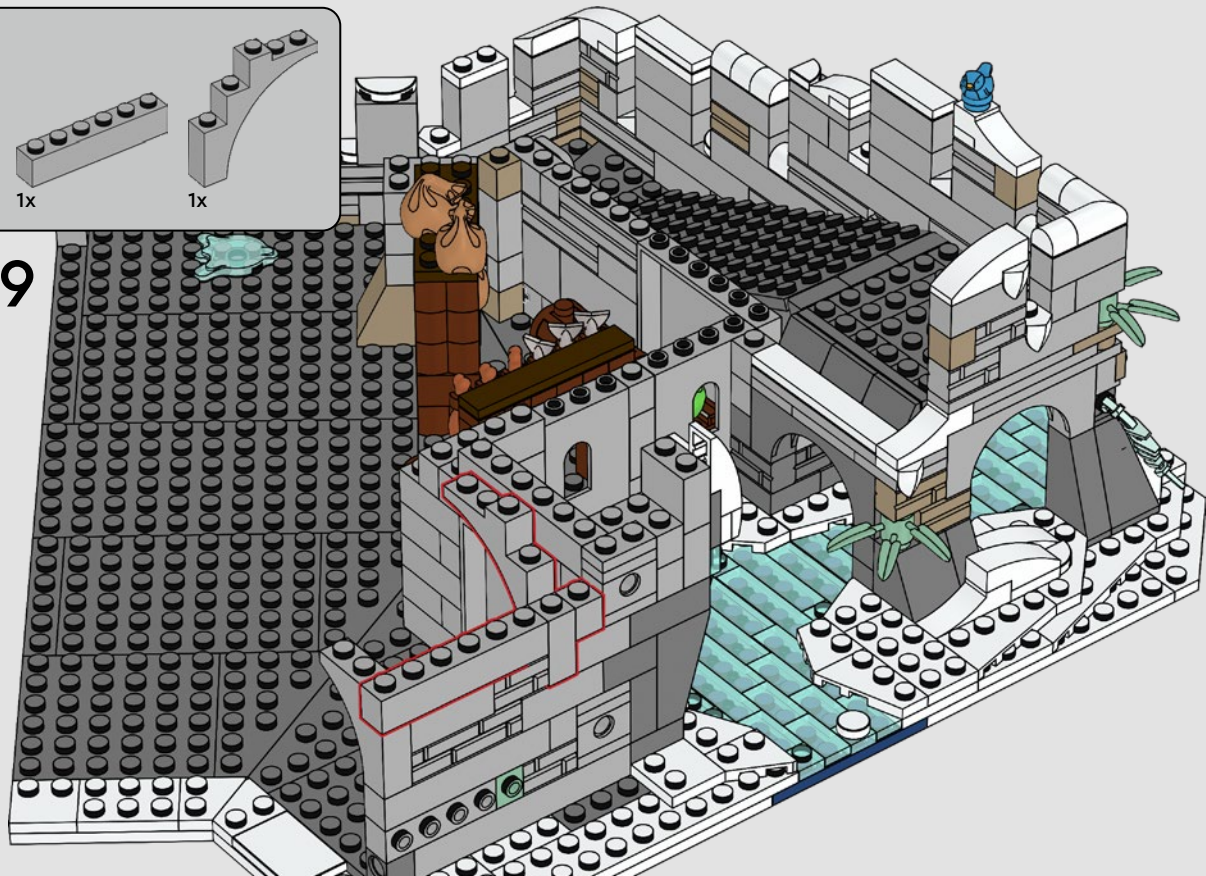

180

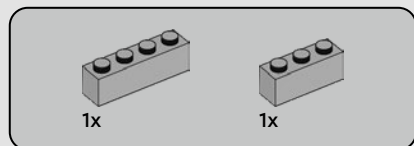

190

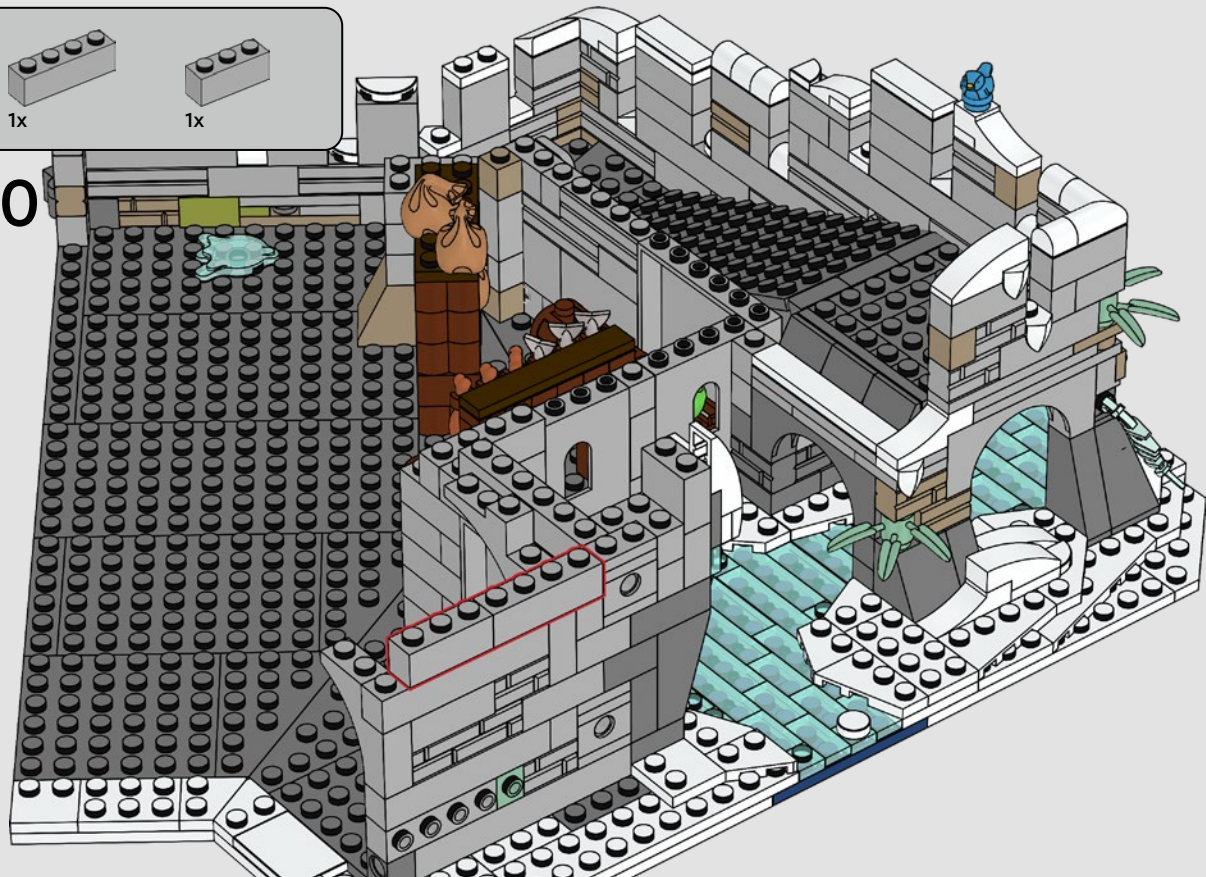

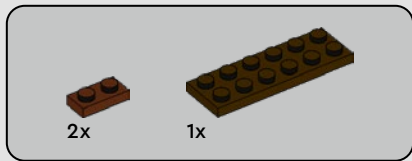

191

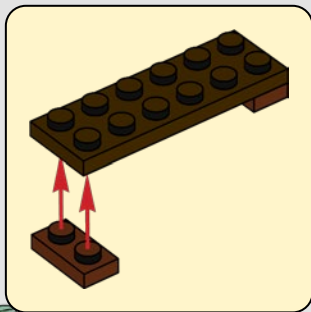



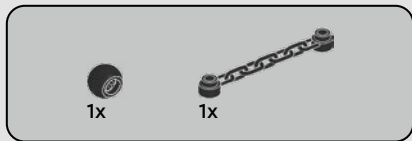

193

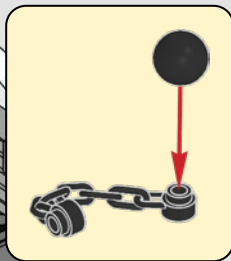



1x



1x

194

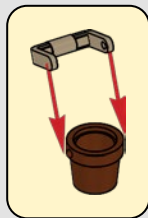

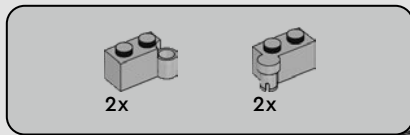

195

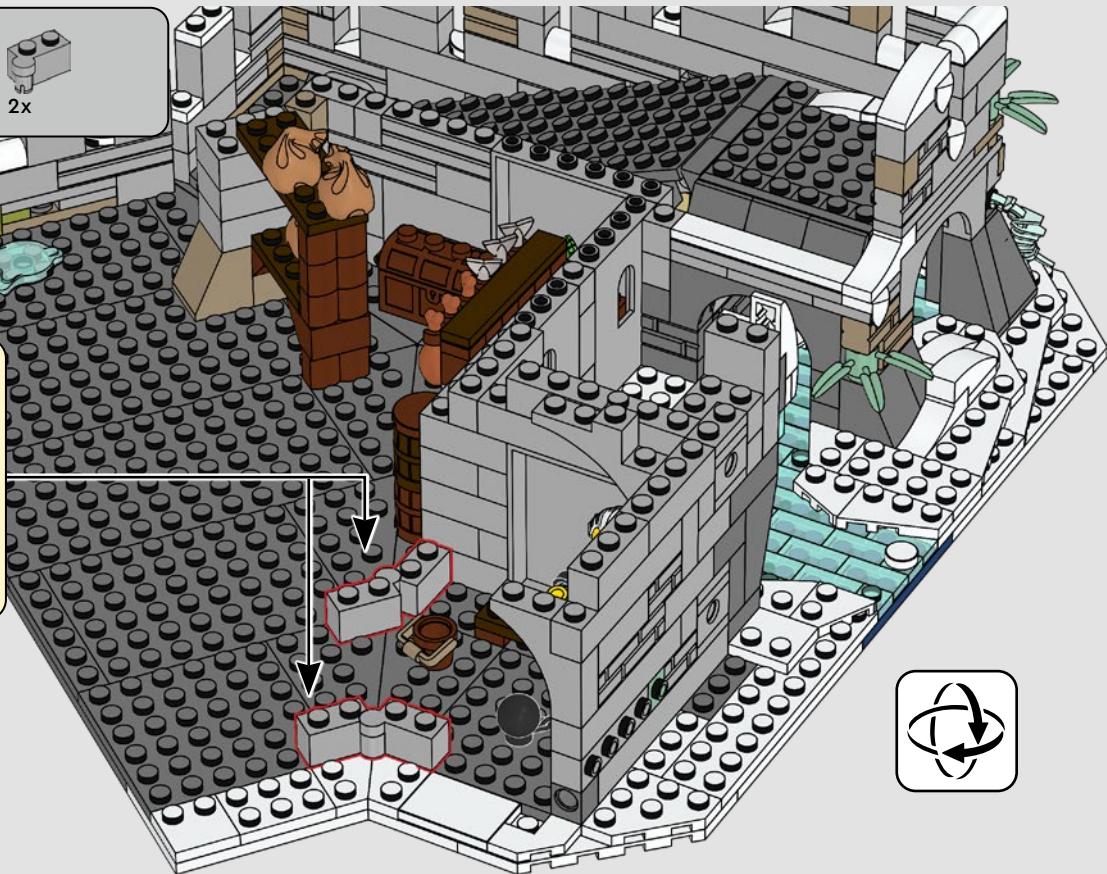
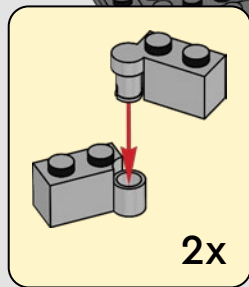

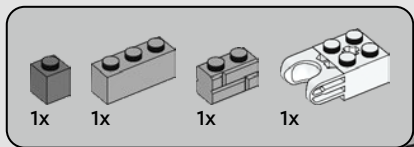

196

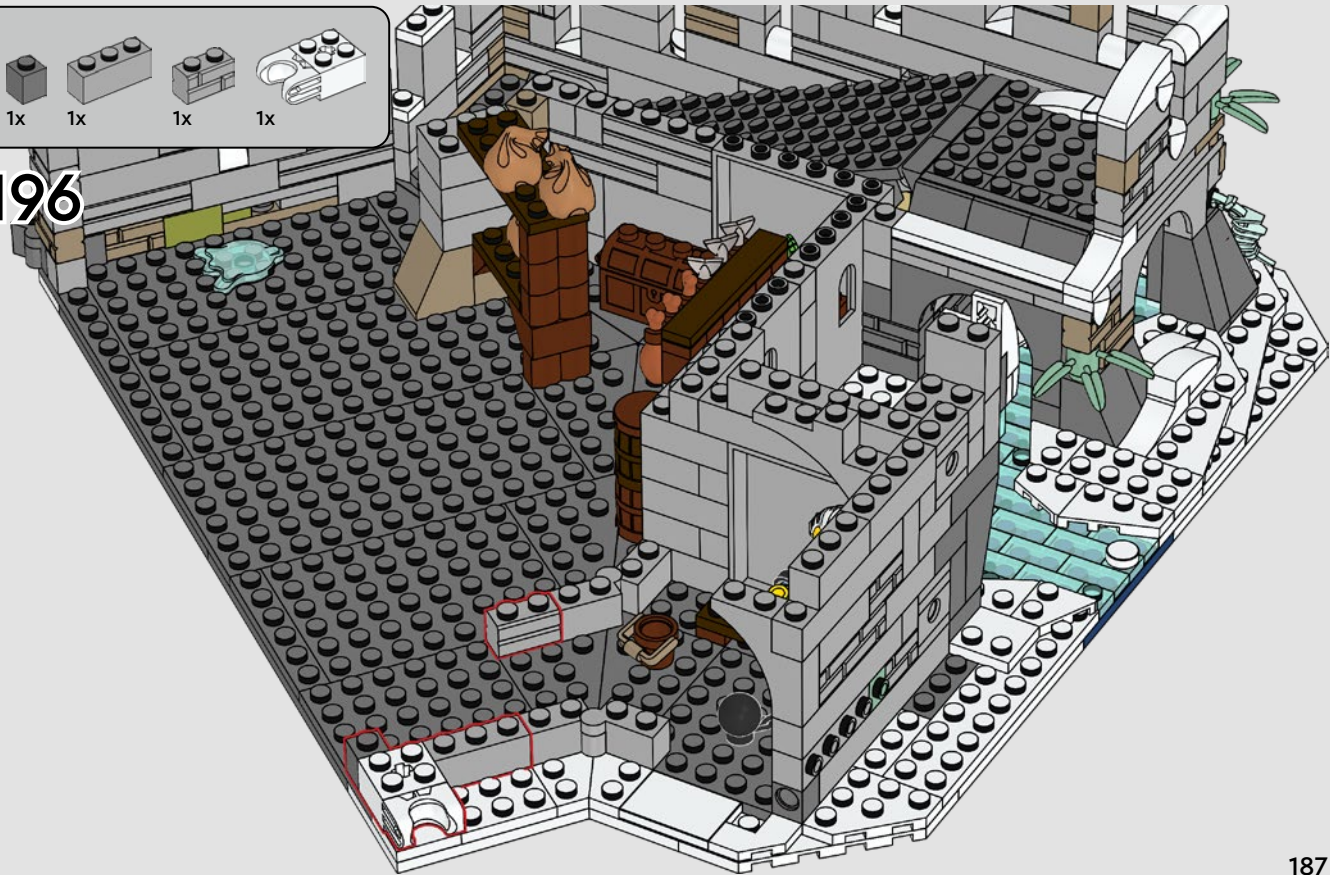

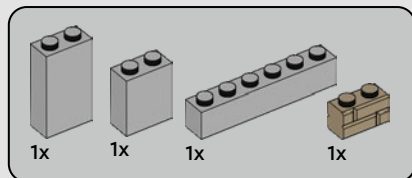

197

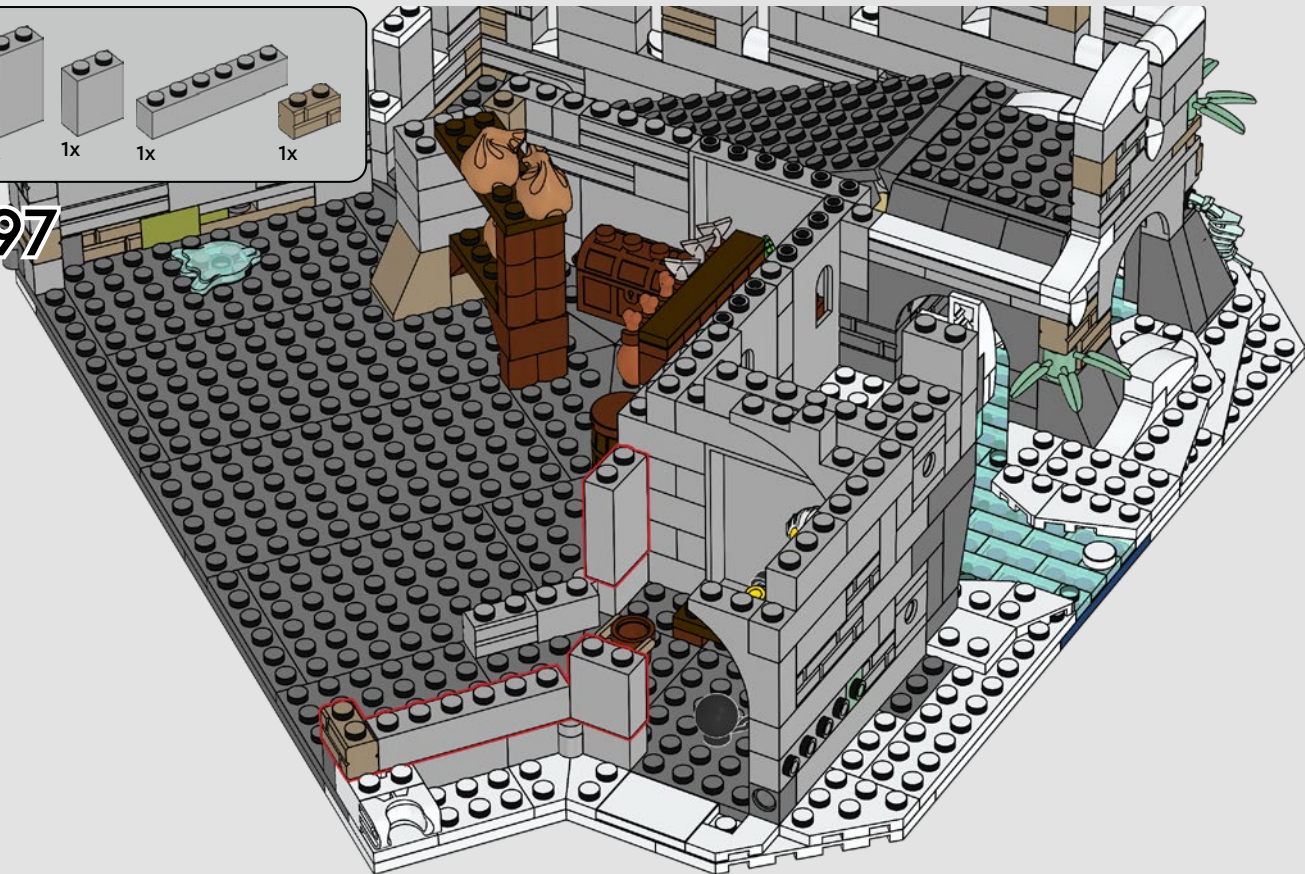

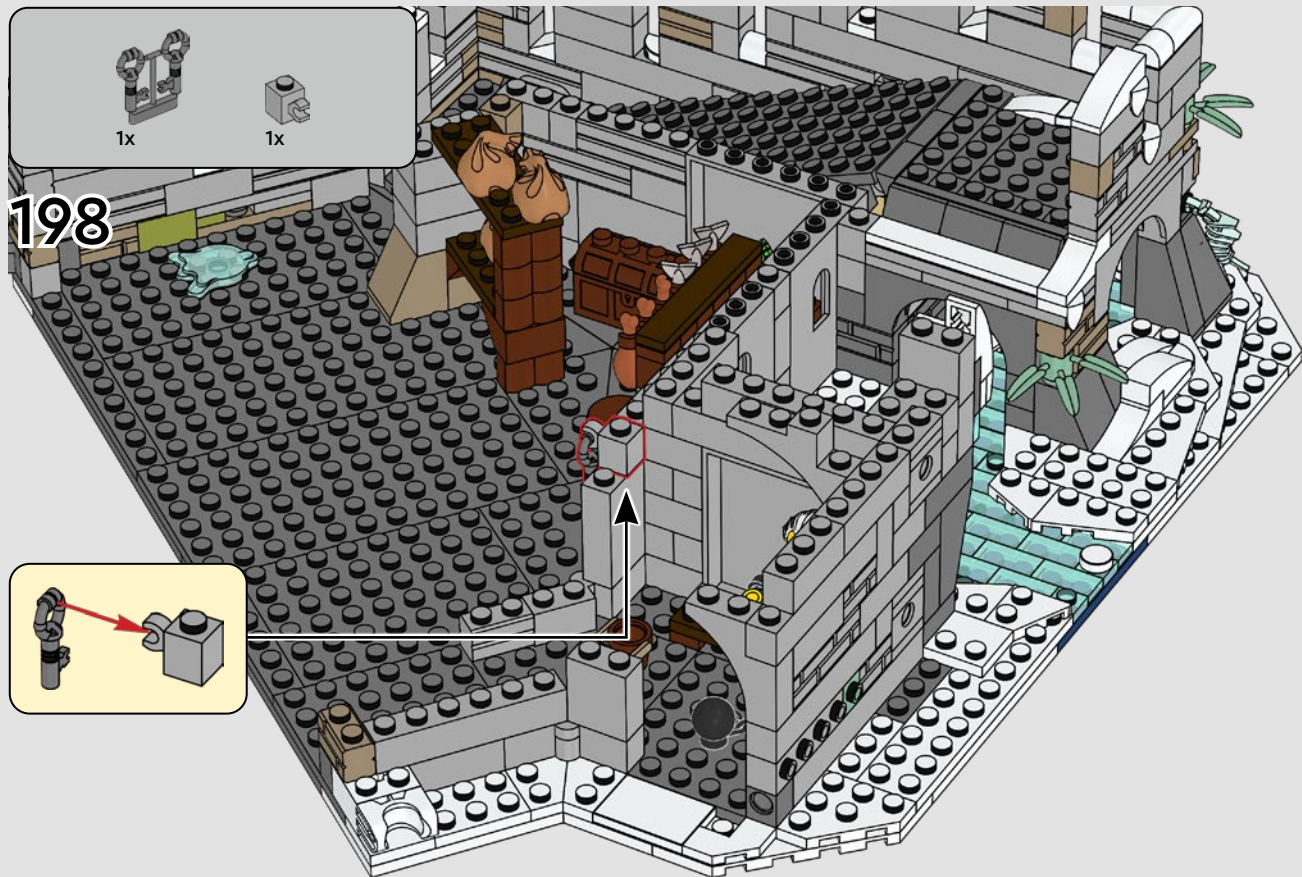

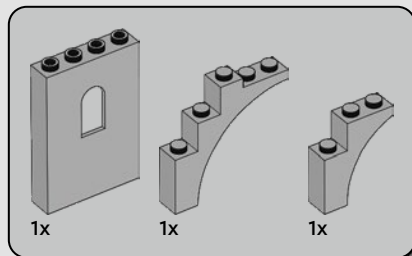

199

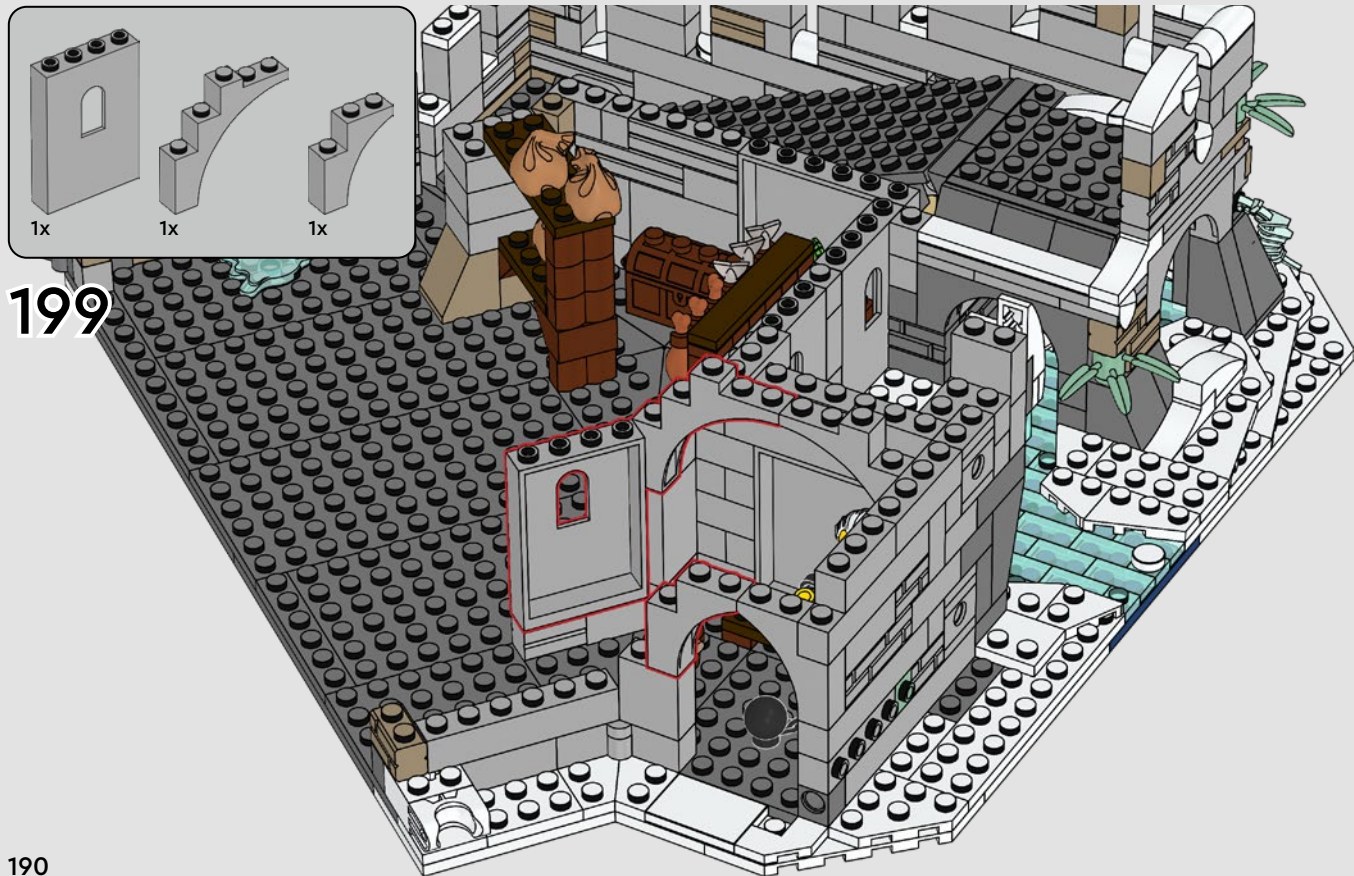

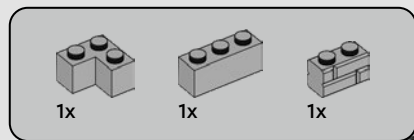

200

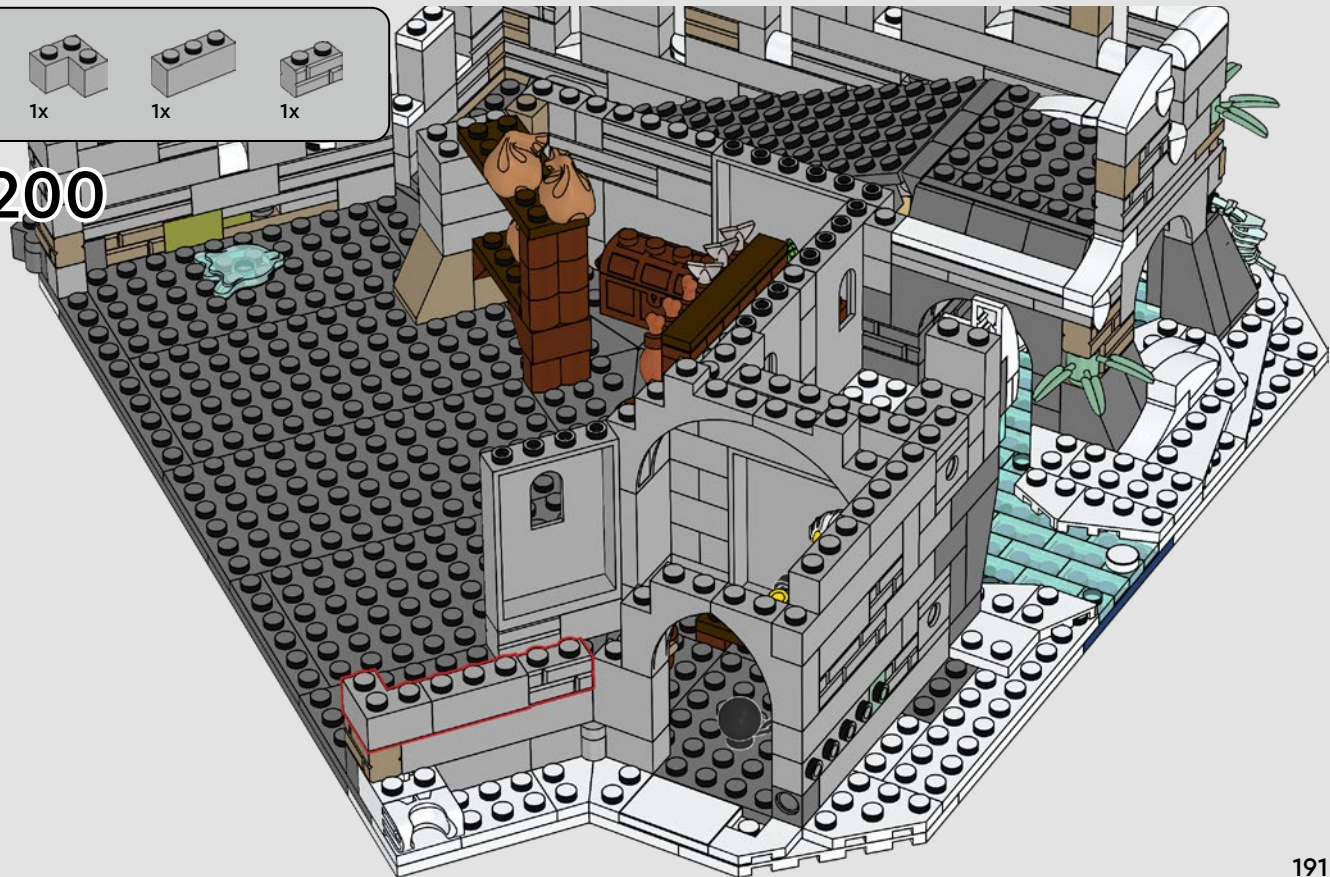

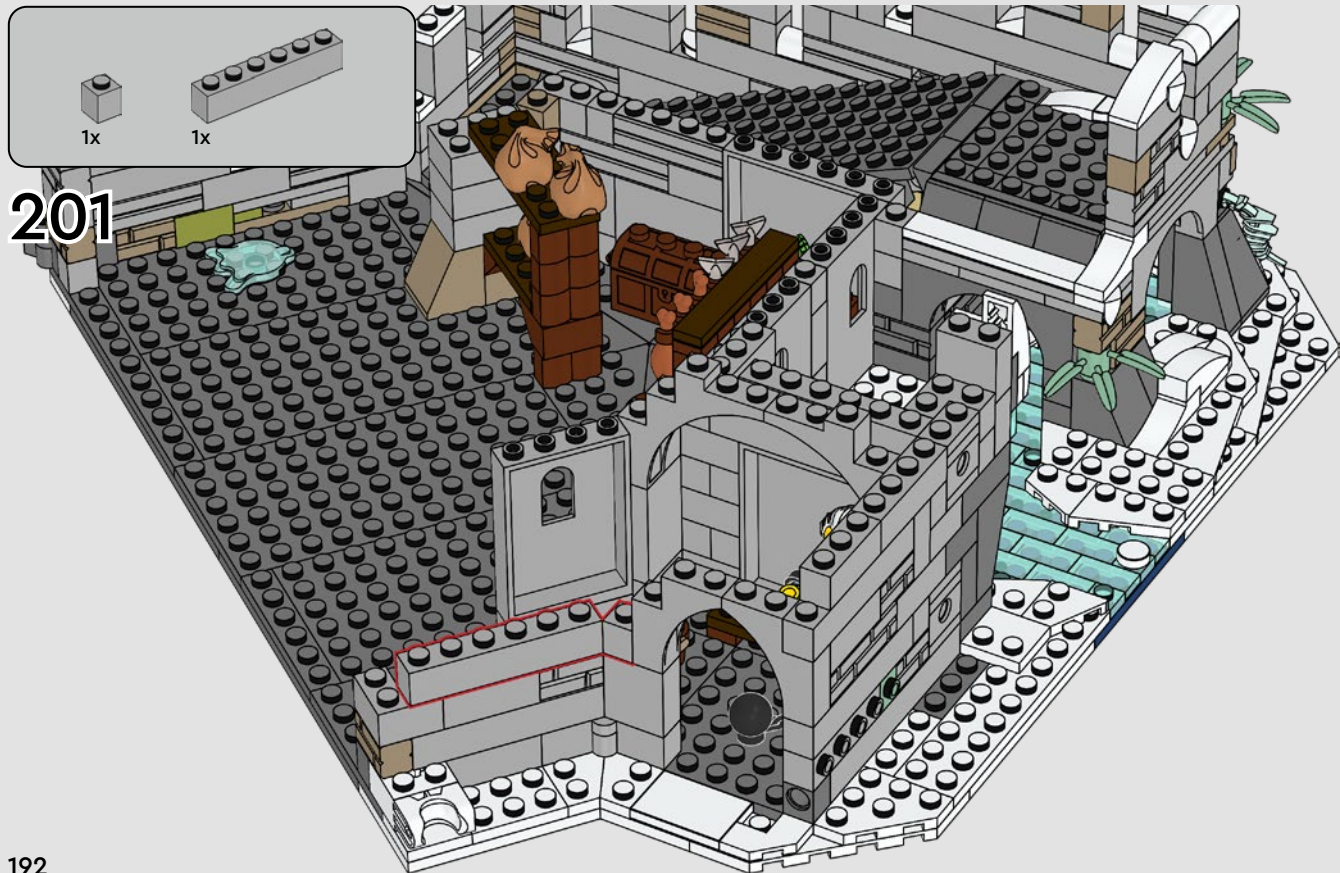

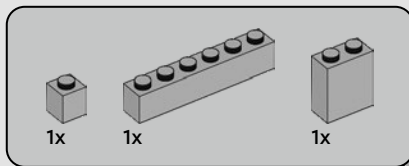

202

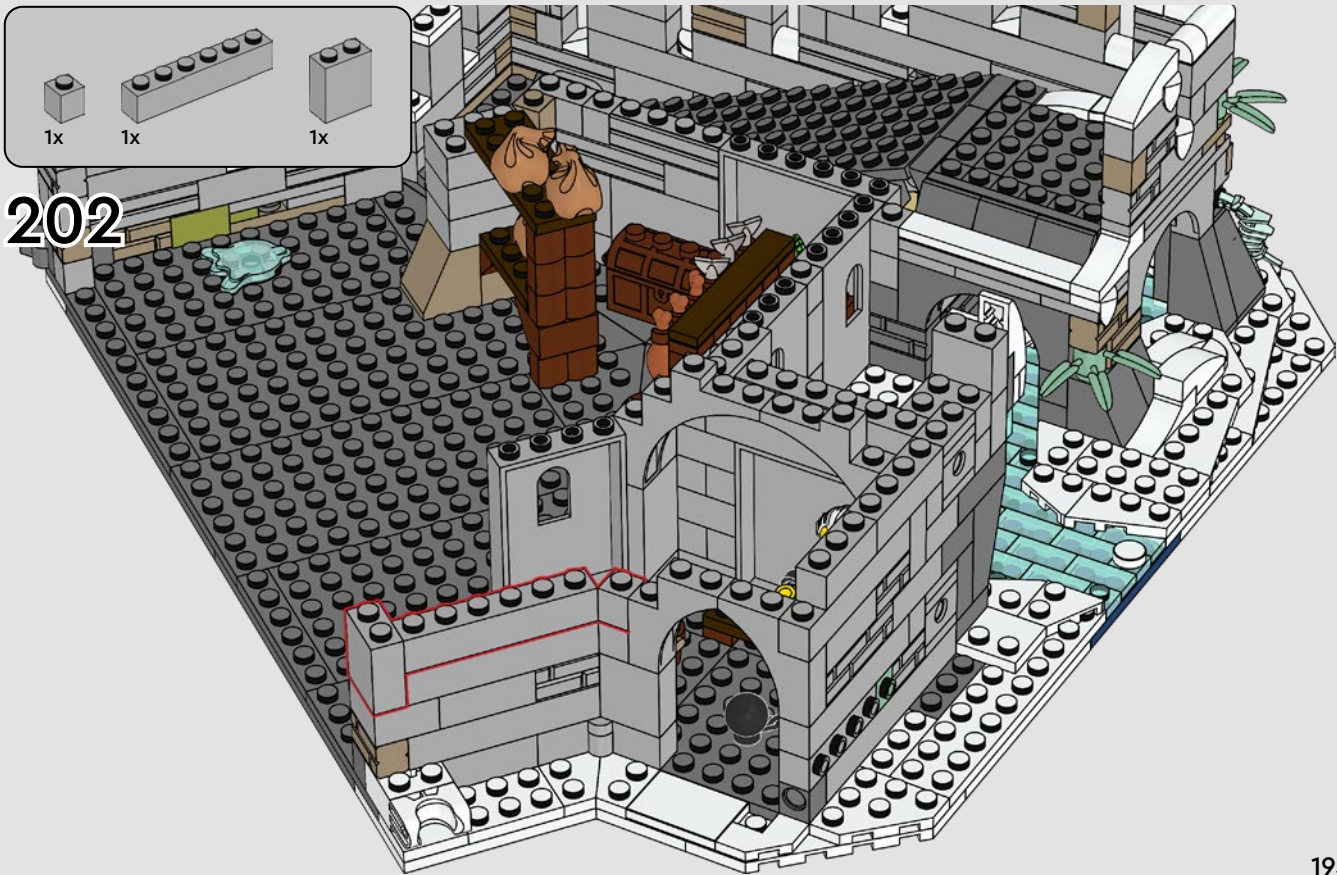

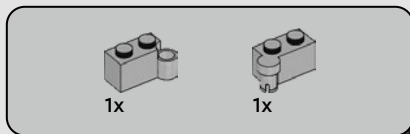

203

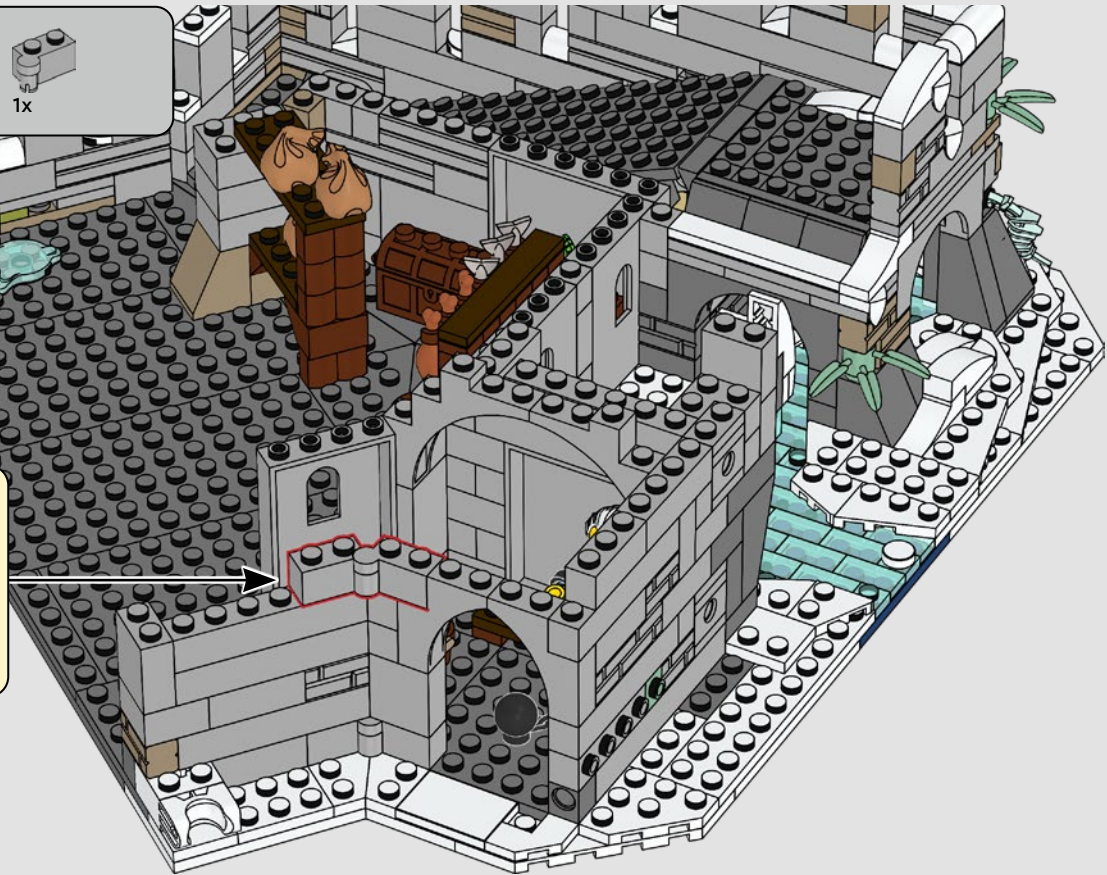
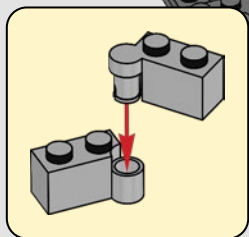

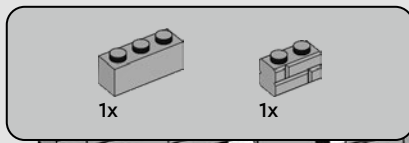

204

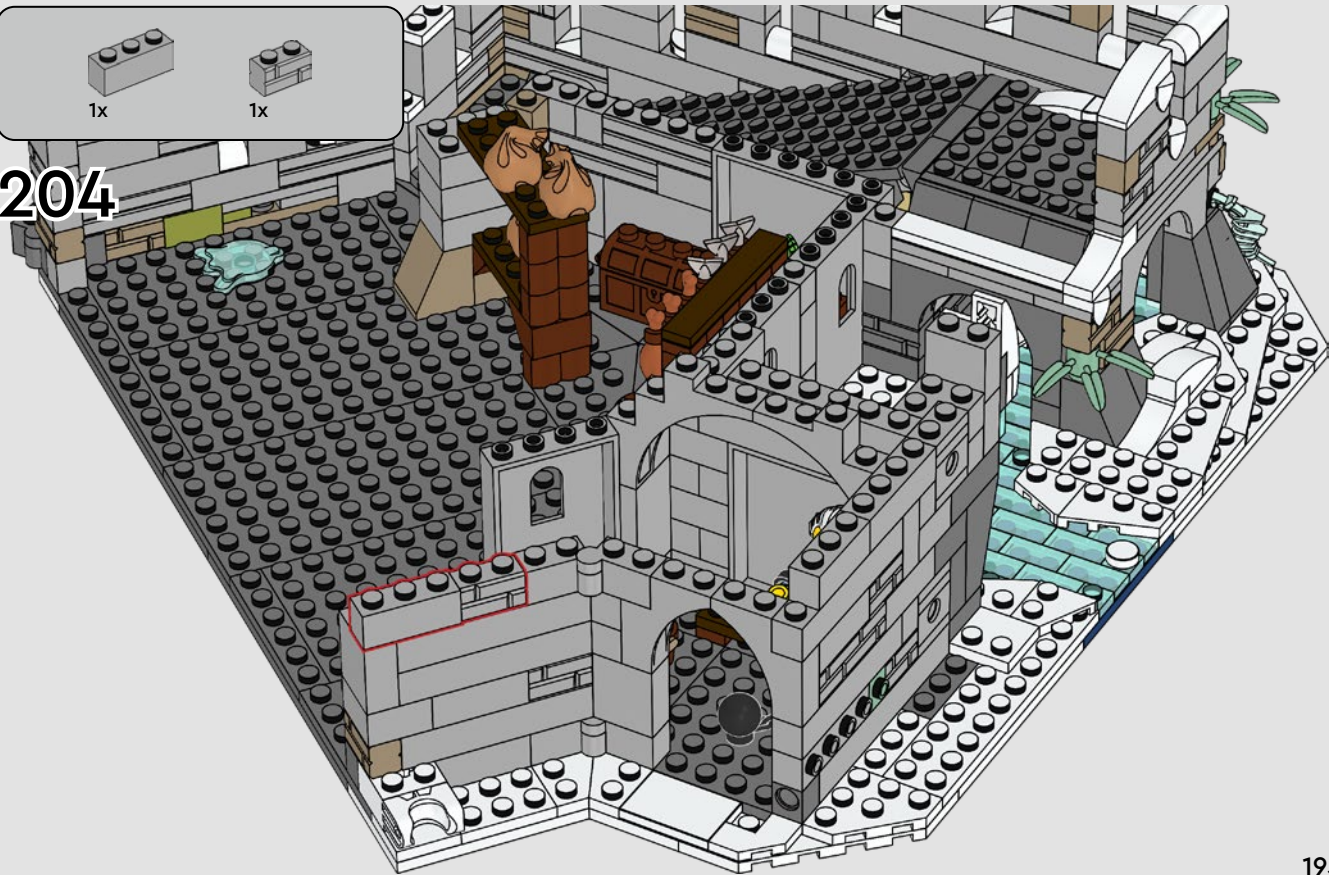

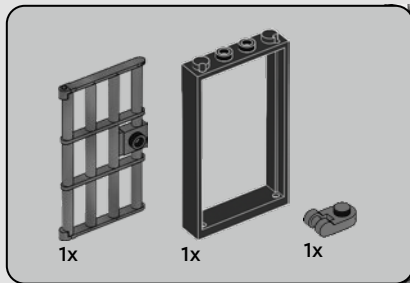

205

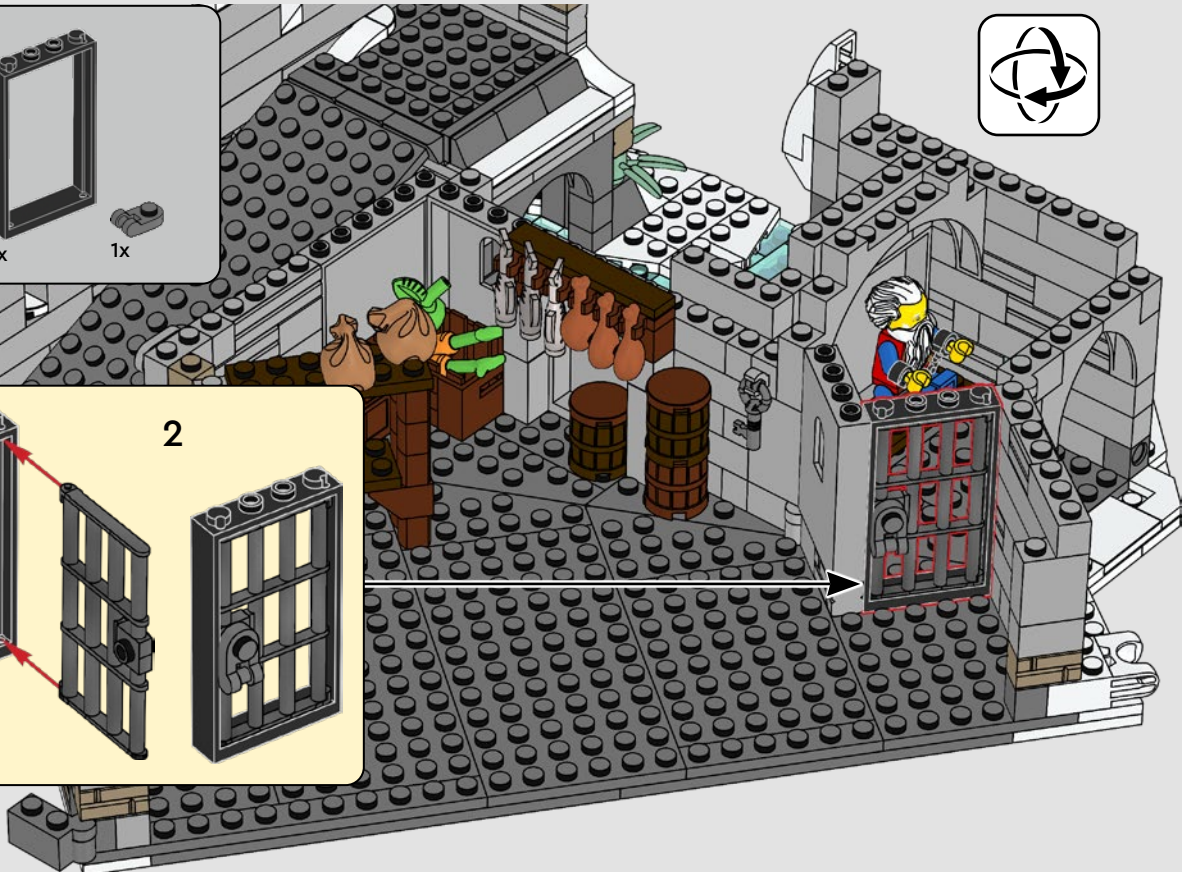
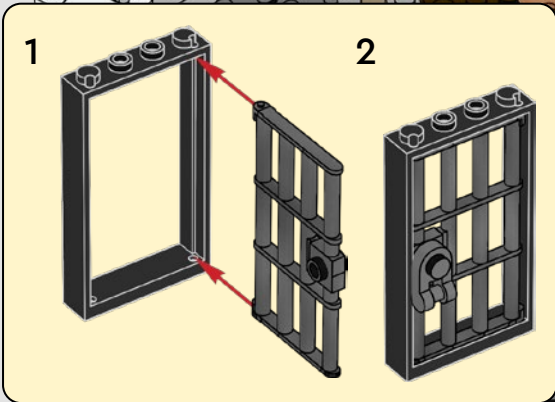

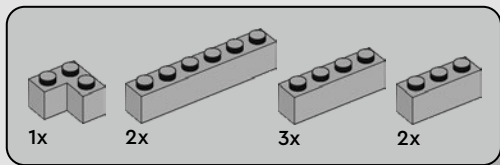

206

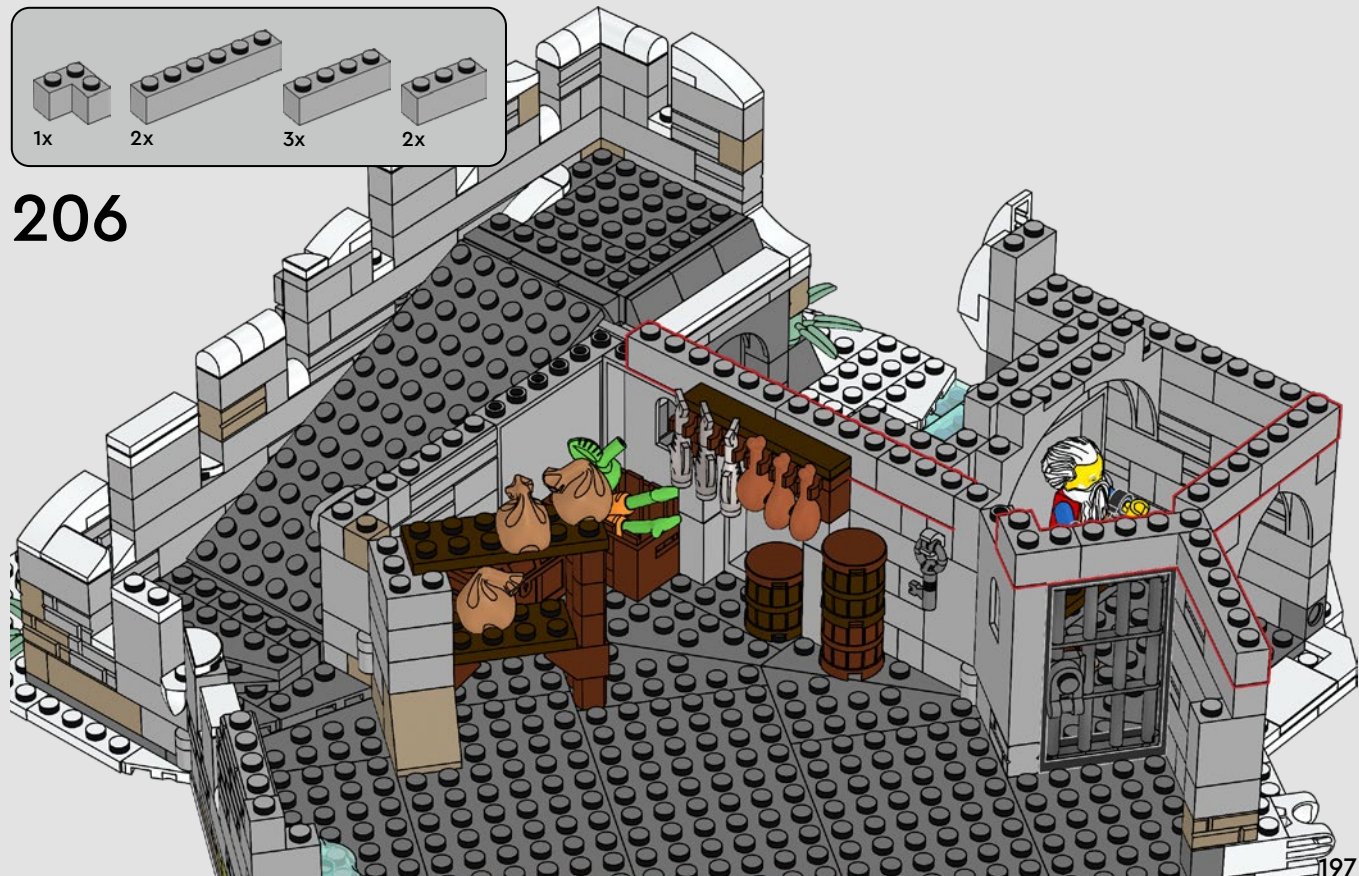

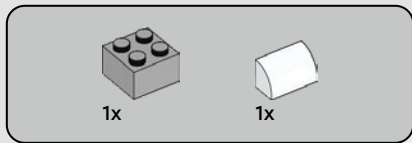

207

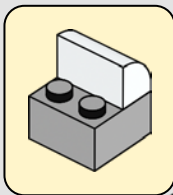

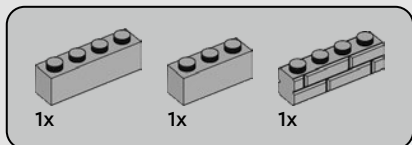

208

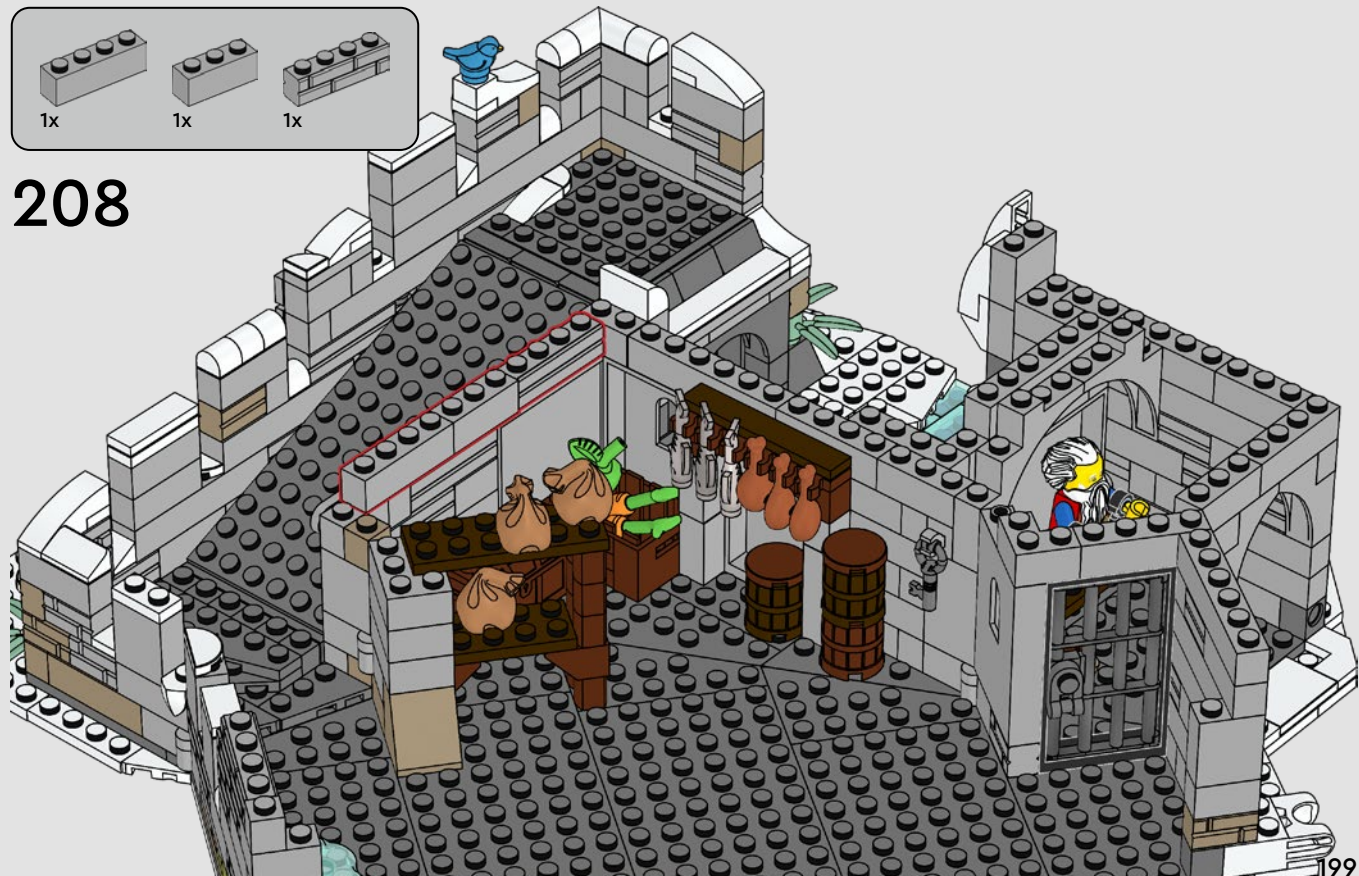

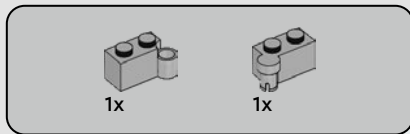

209

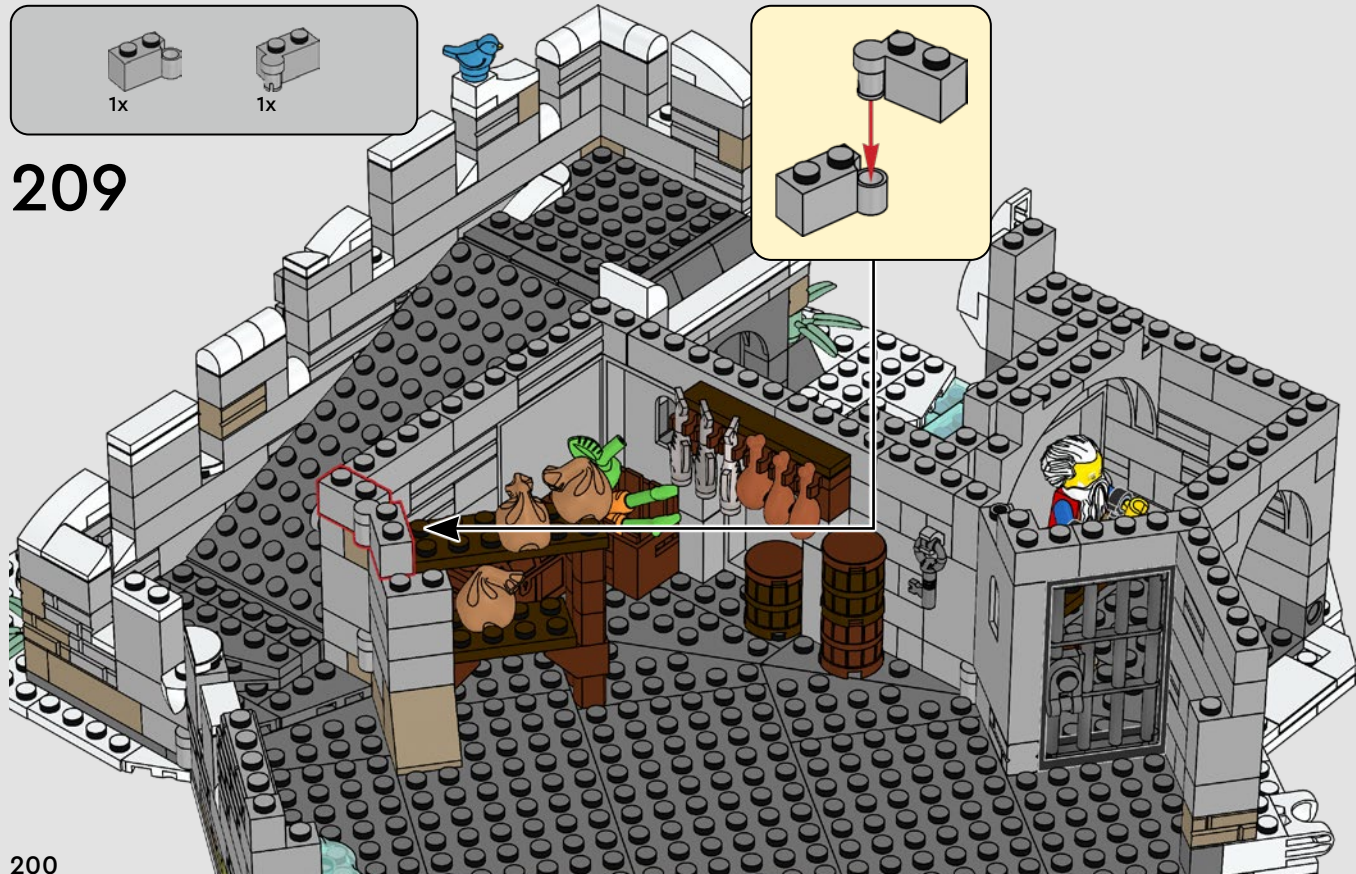
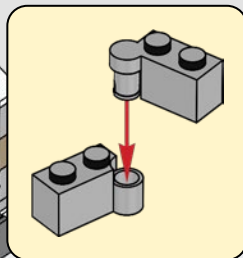

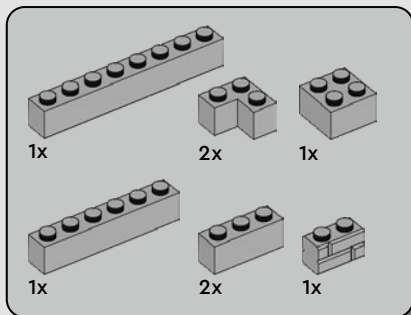

210

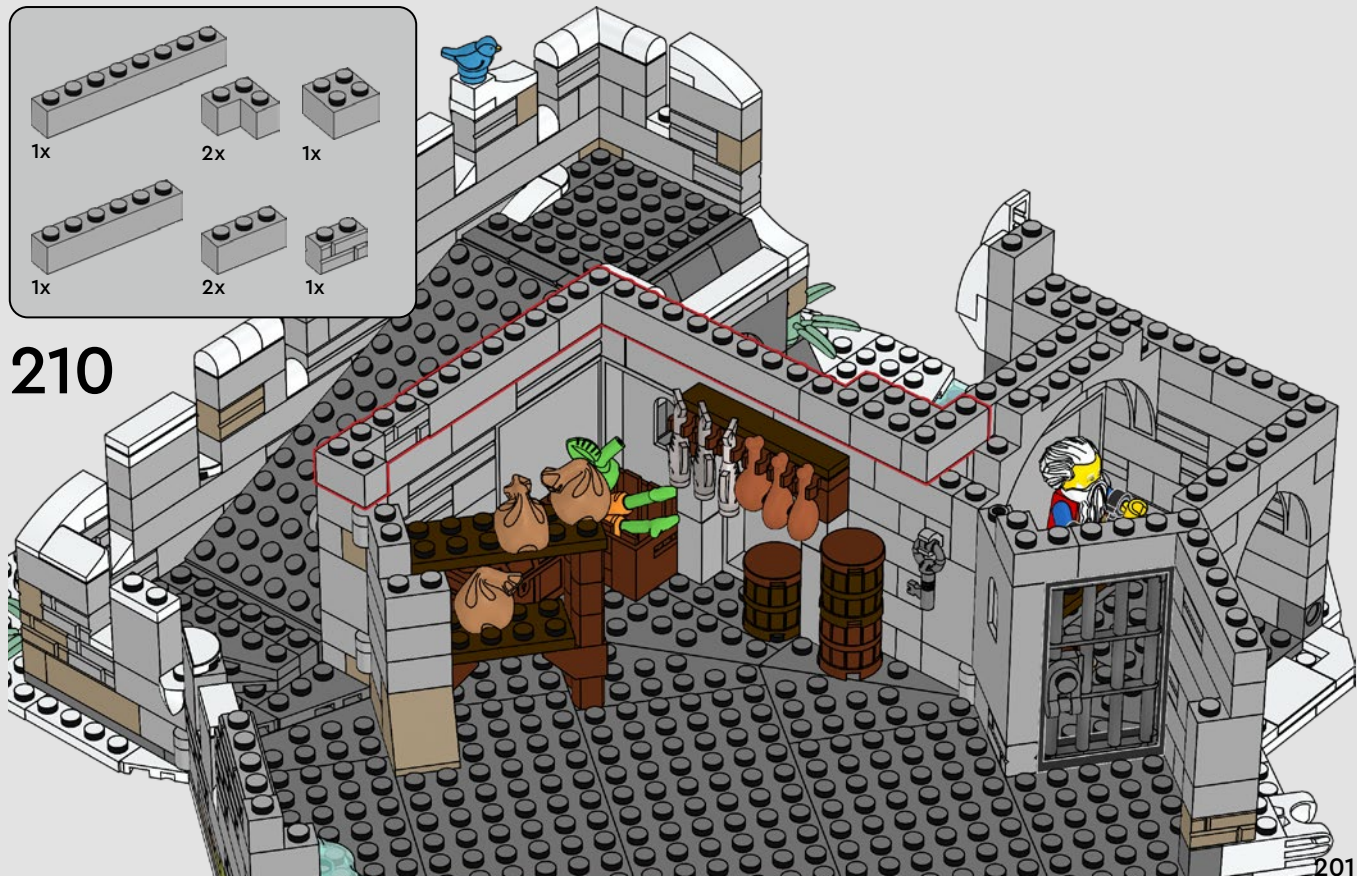

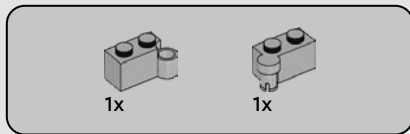

211

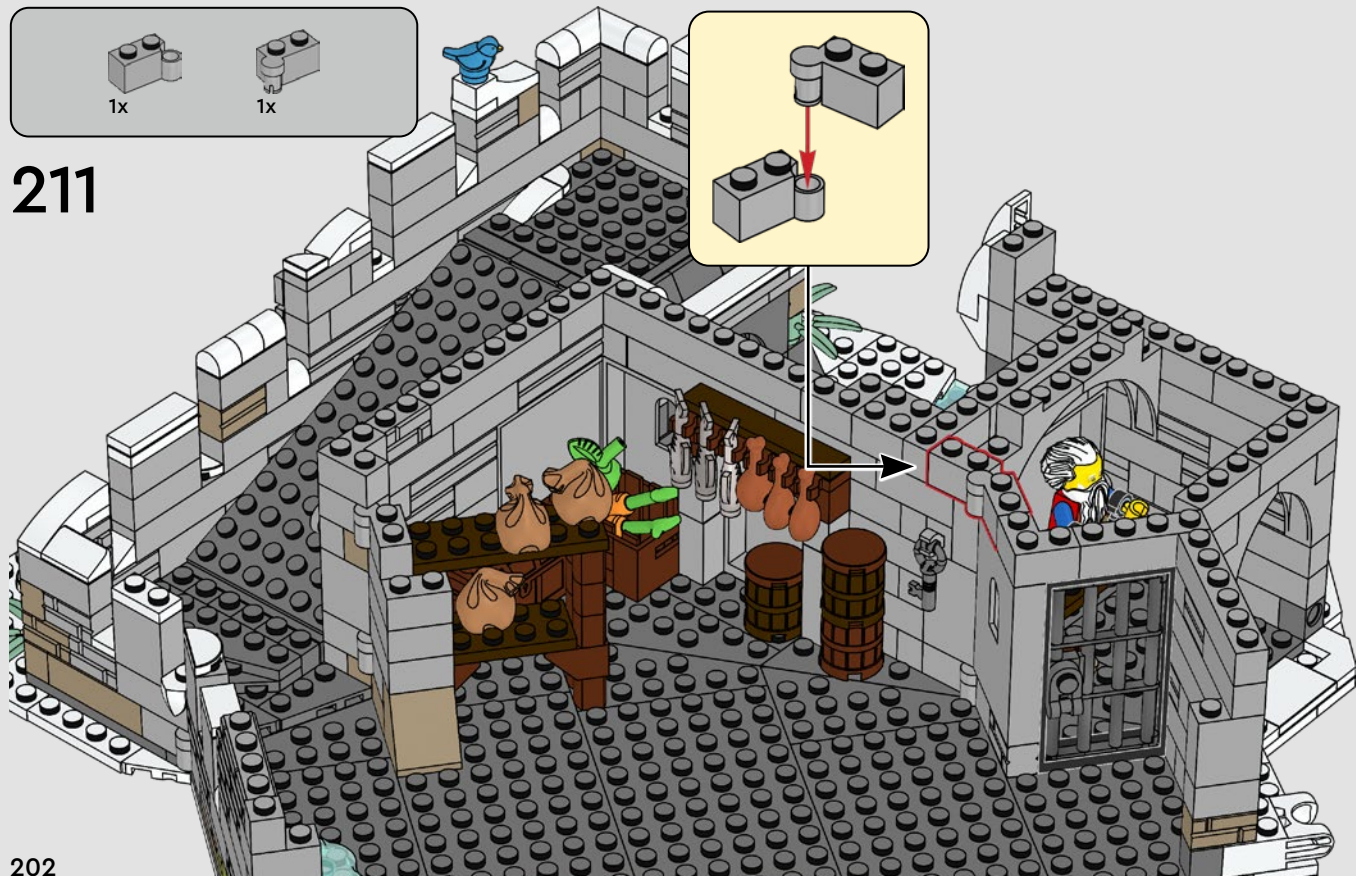
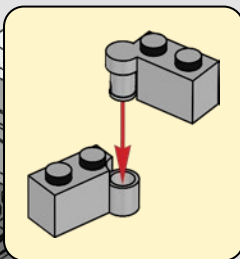

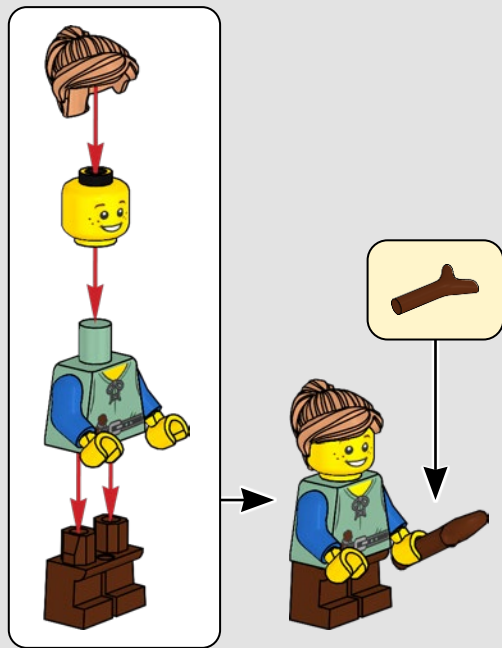

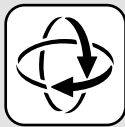
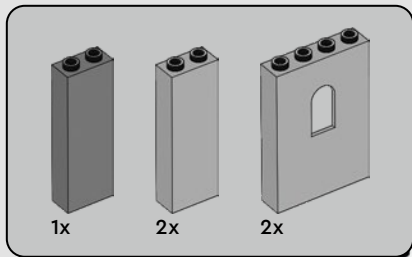

212



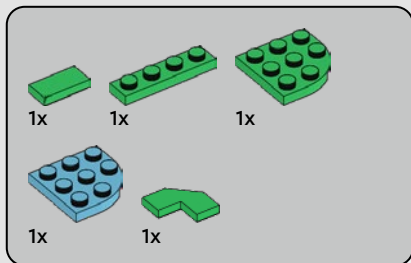

213



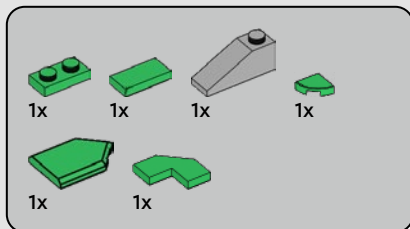

214

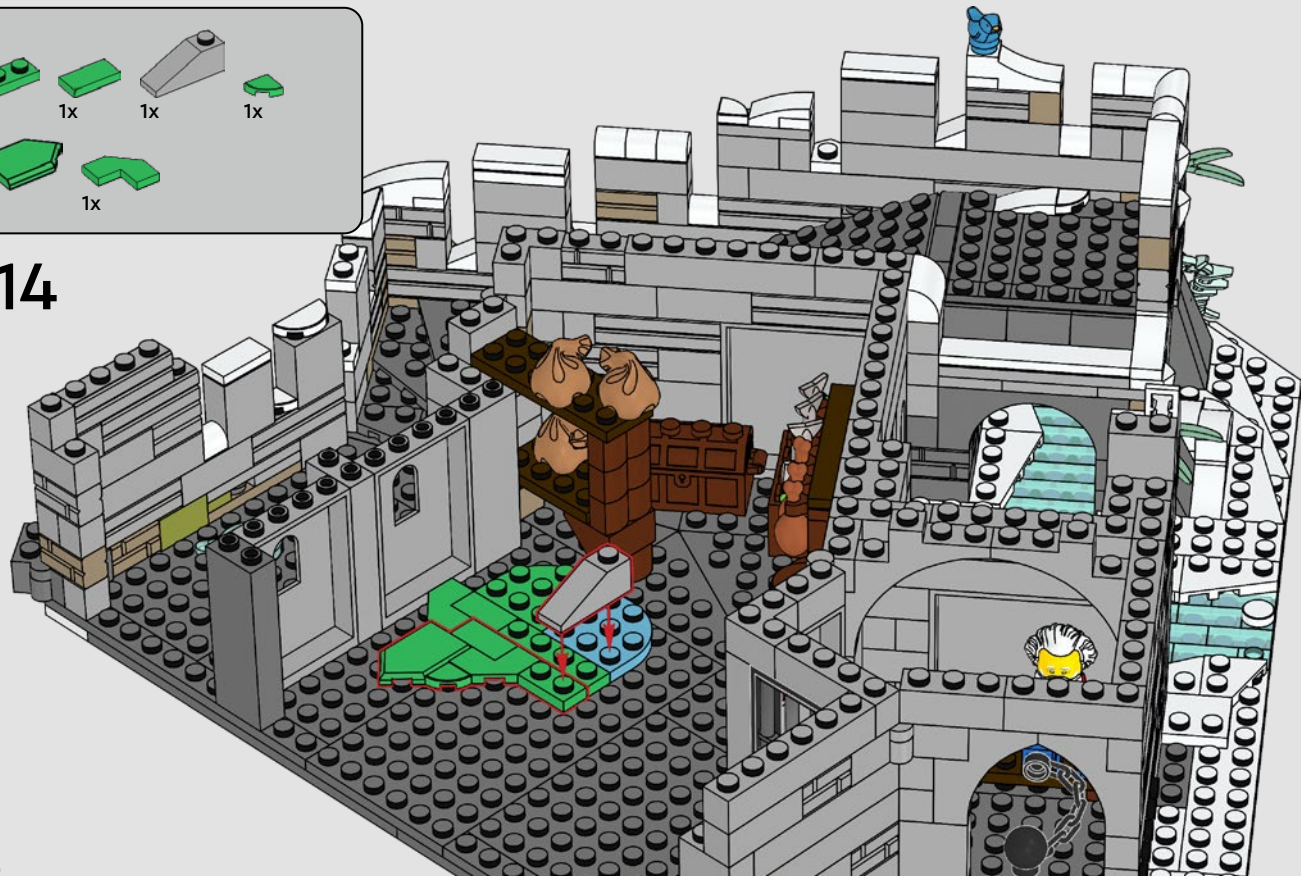

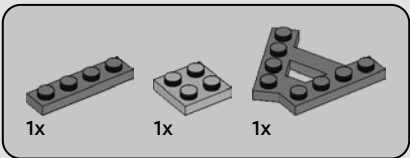
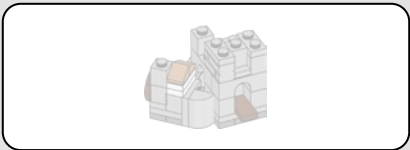

215

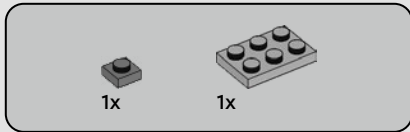
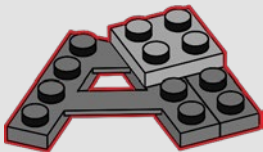

216

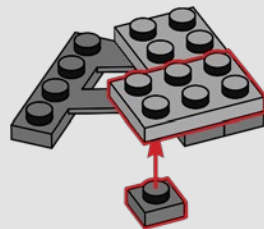



1x



1x

217

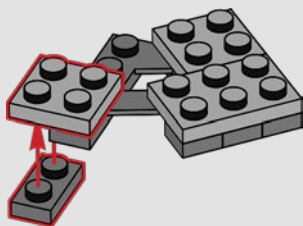

1x



1x

218

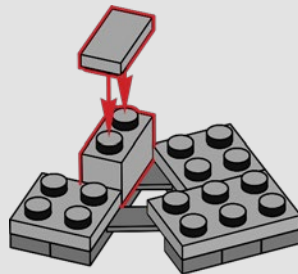

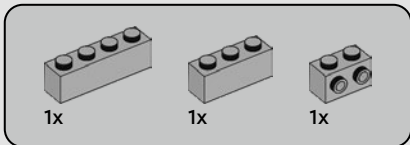

219

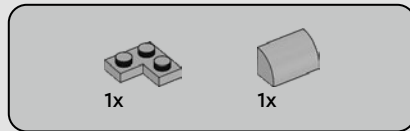
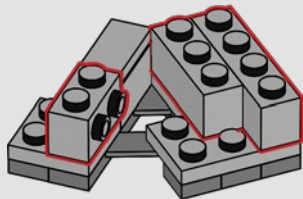

220

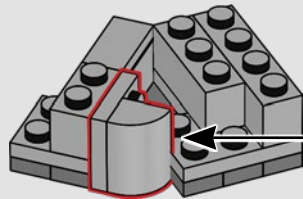
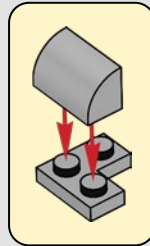



1x



1x



221

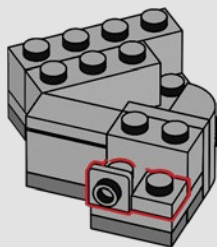

1x



1x

222

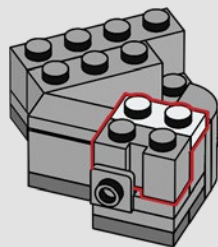



1x



2x

223

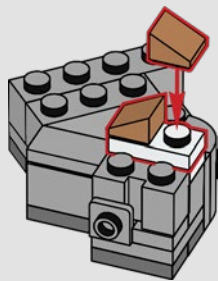

1x



1x

224

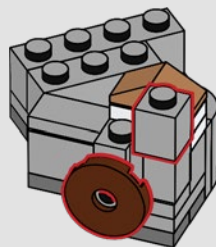

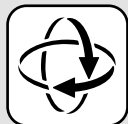
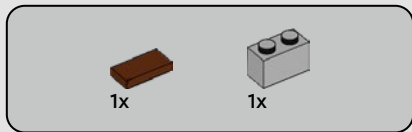

225

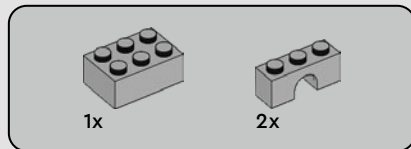
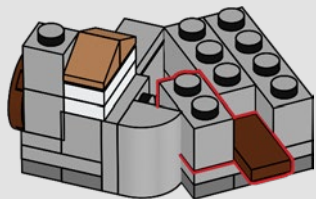

226

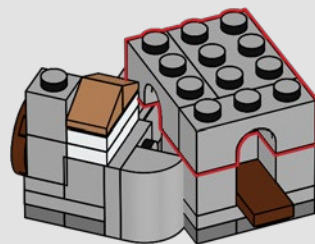



2x



1x

227

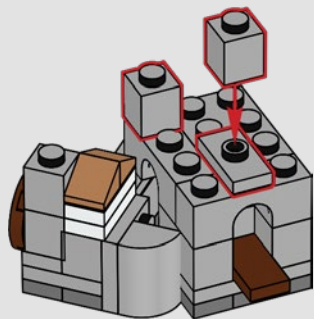

1x



1x

228

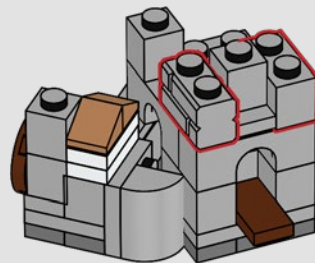

2x

229

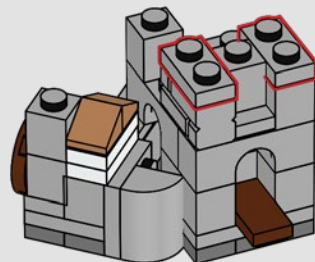

230

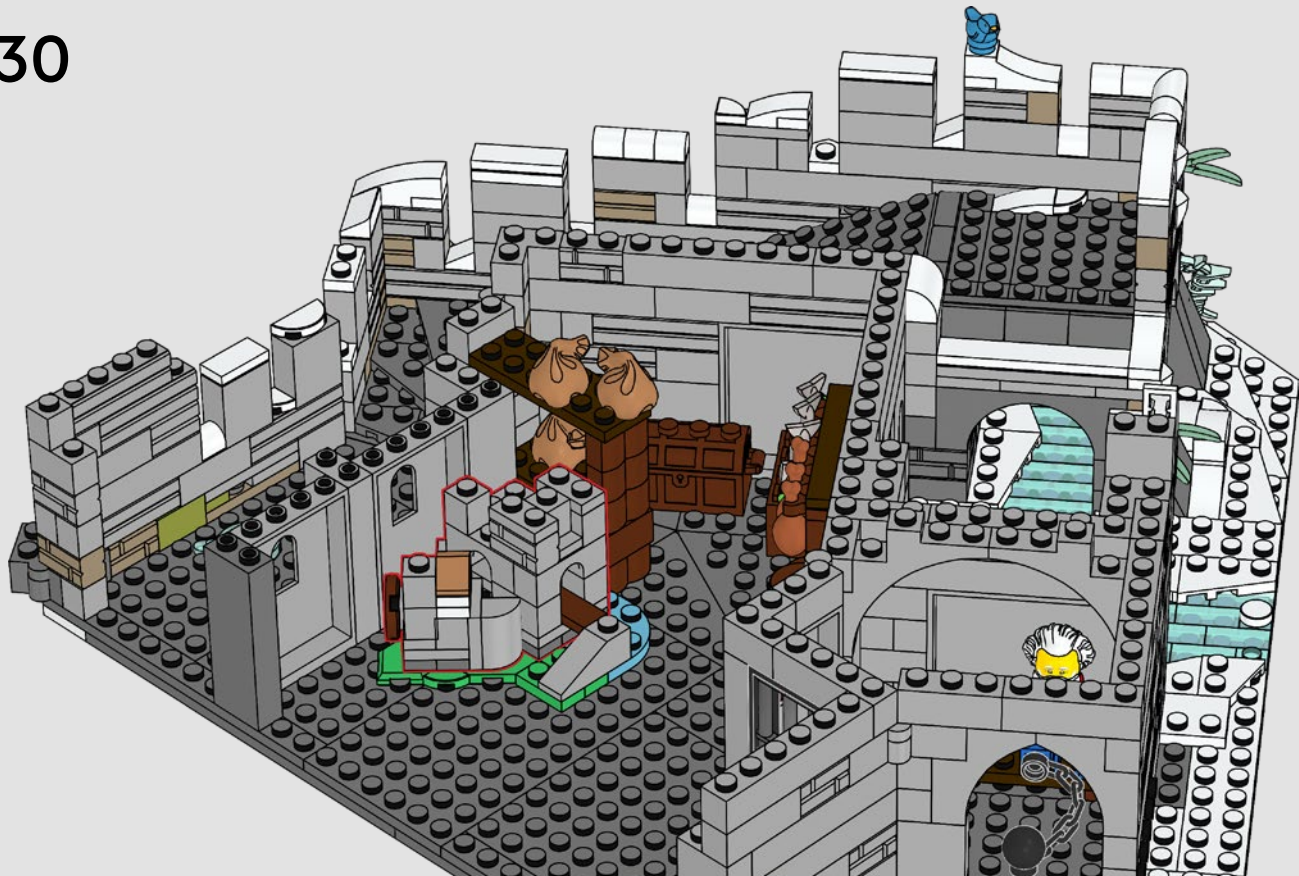

214

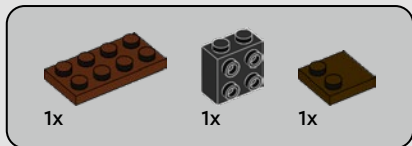

231

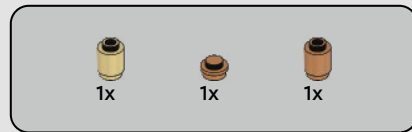
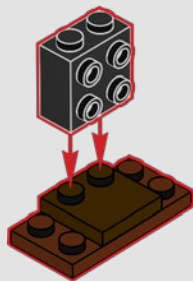

232

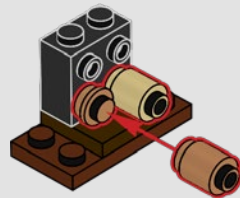



1x



1x

233



1x



2x

234

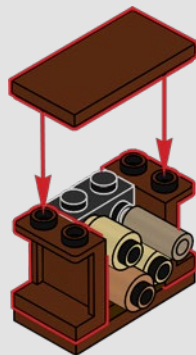

235

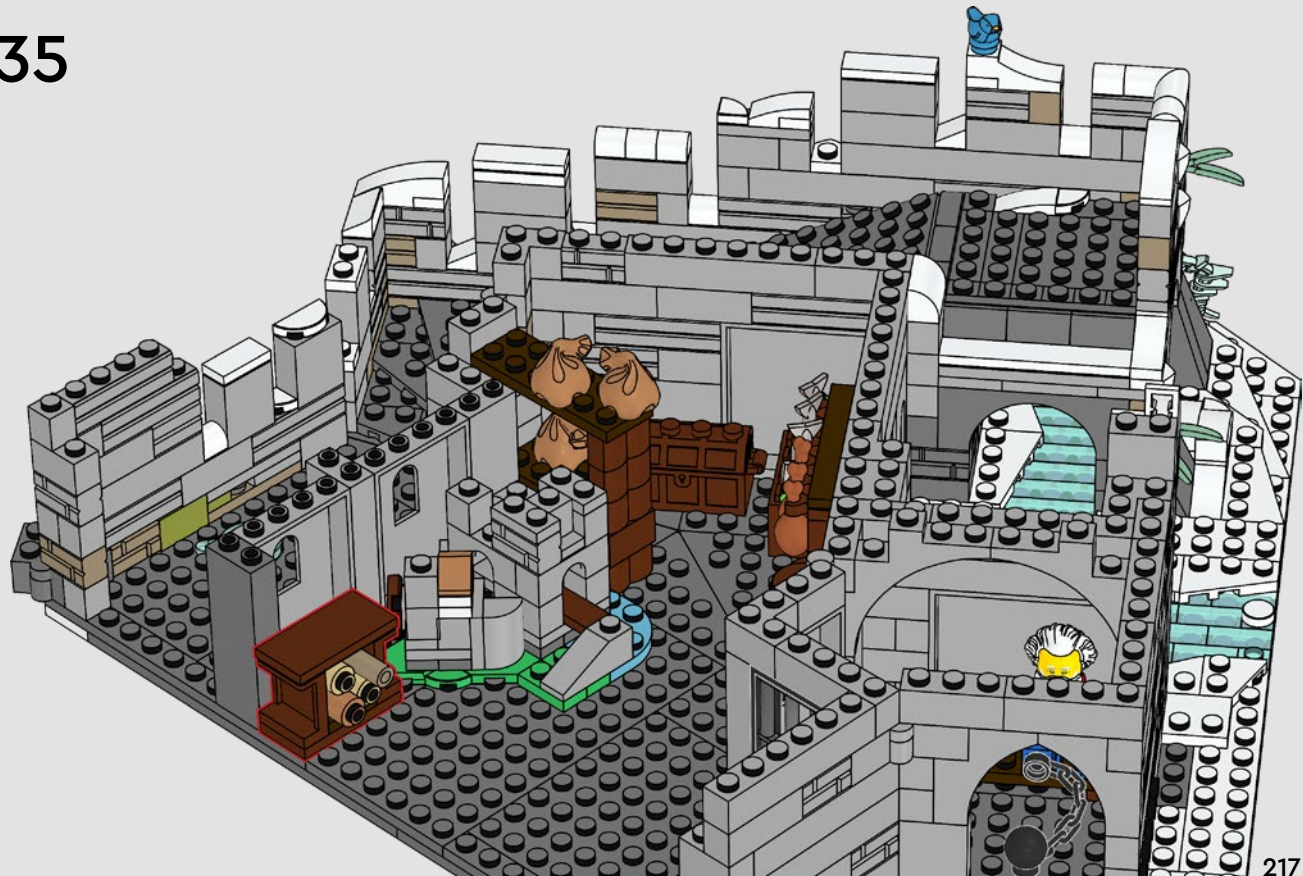

236

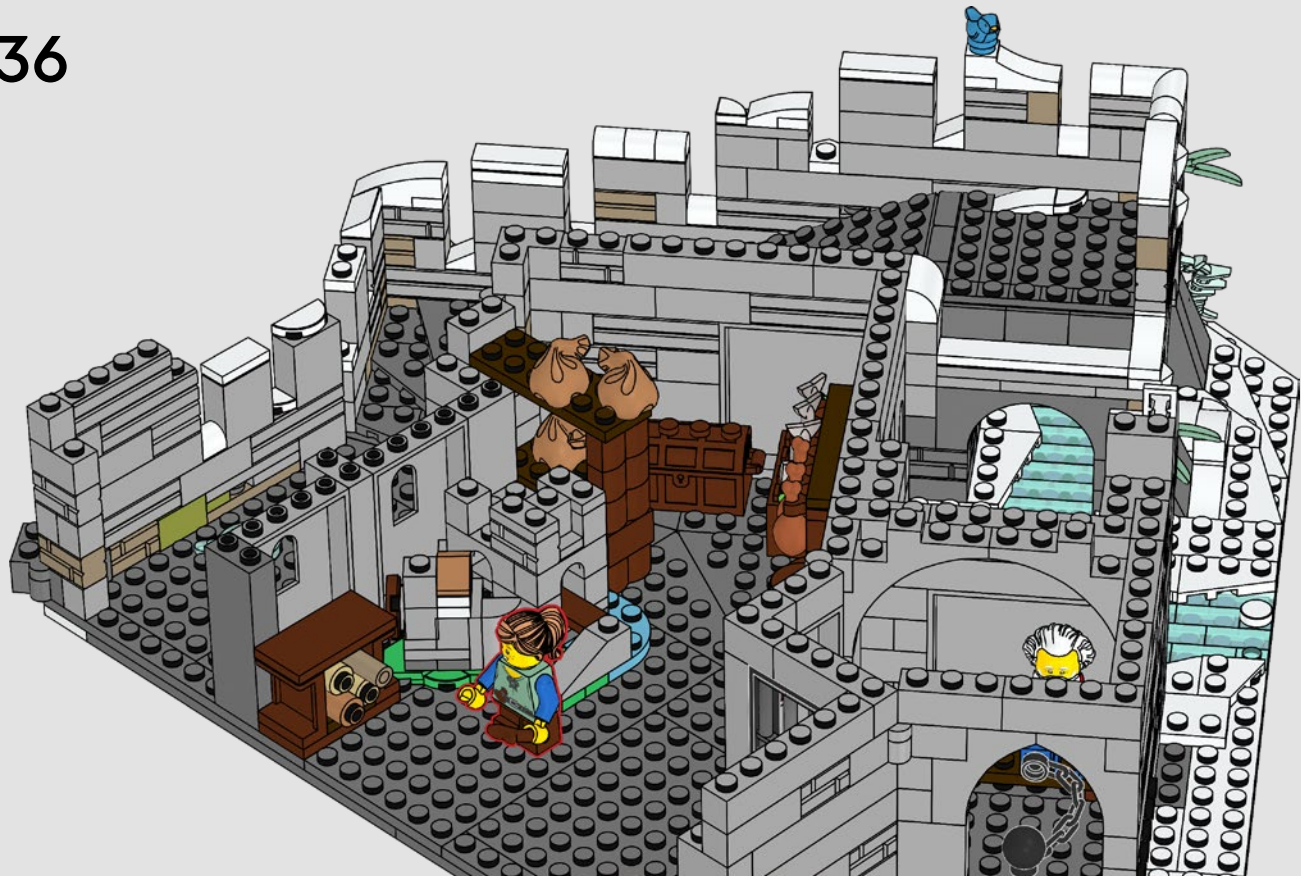



1x



1x



1x



2x

237

1

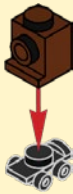

2



3

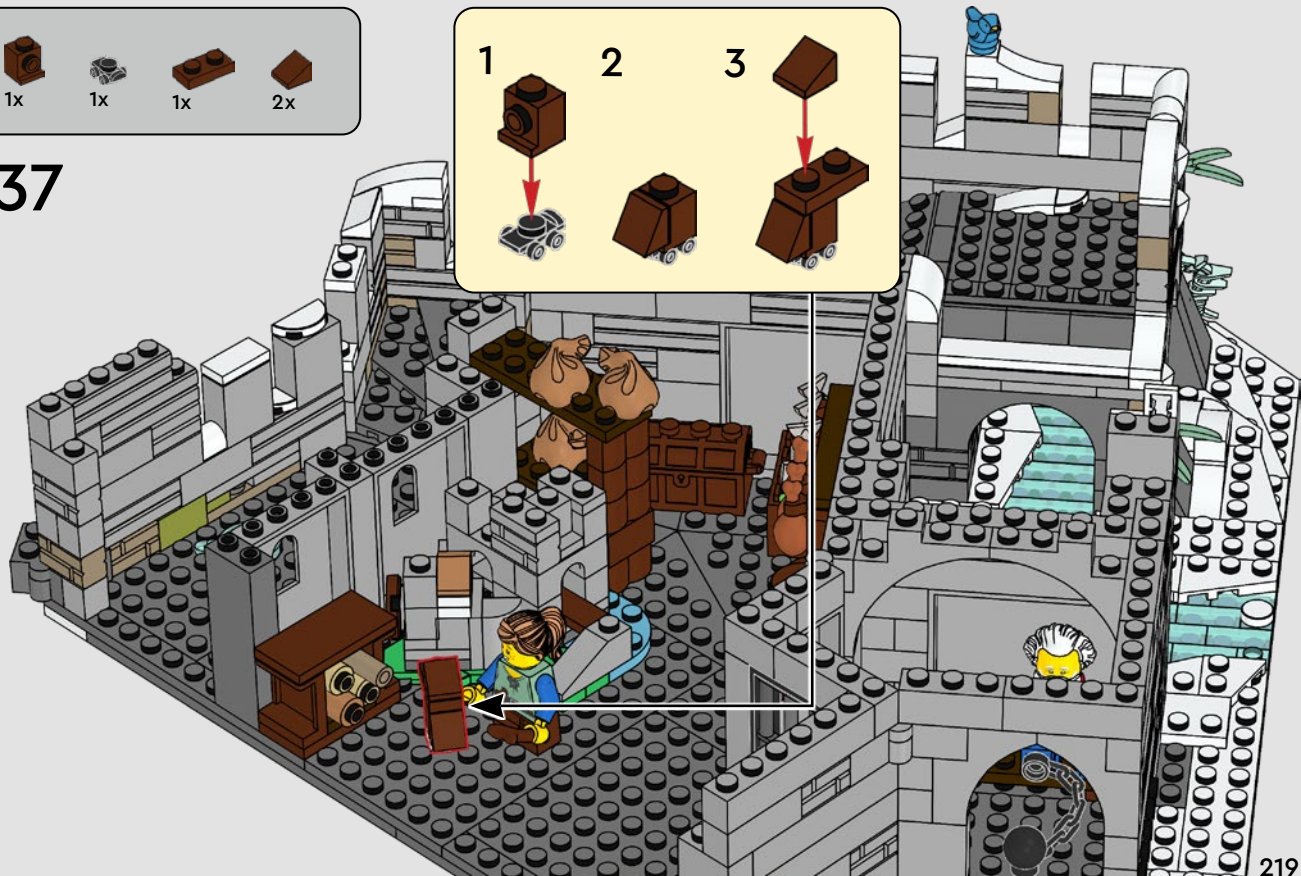

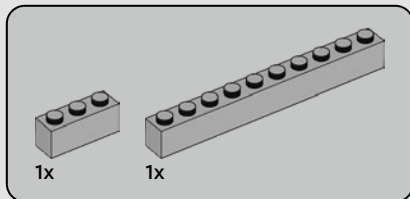

238

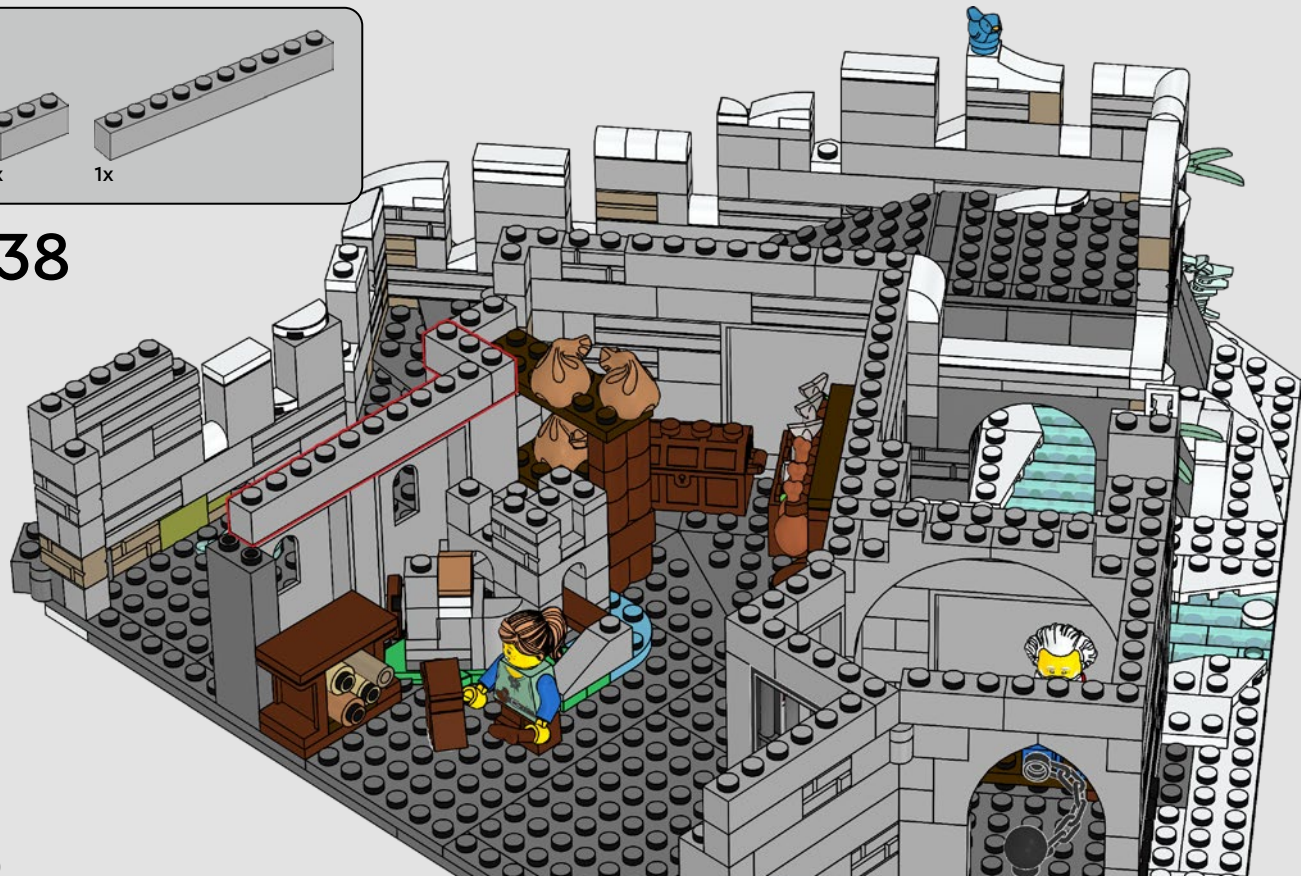

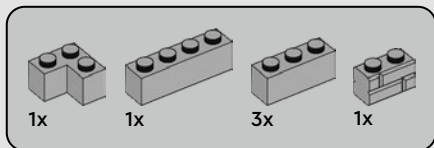

239

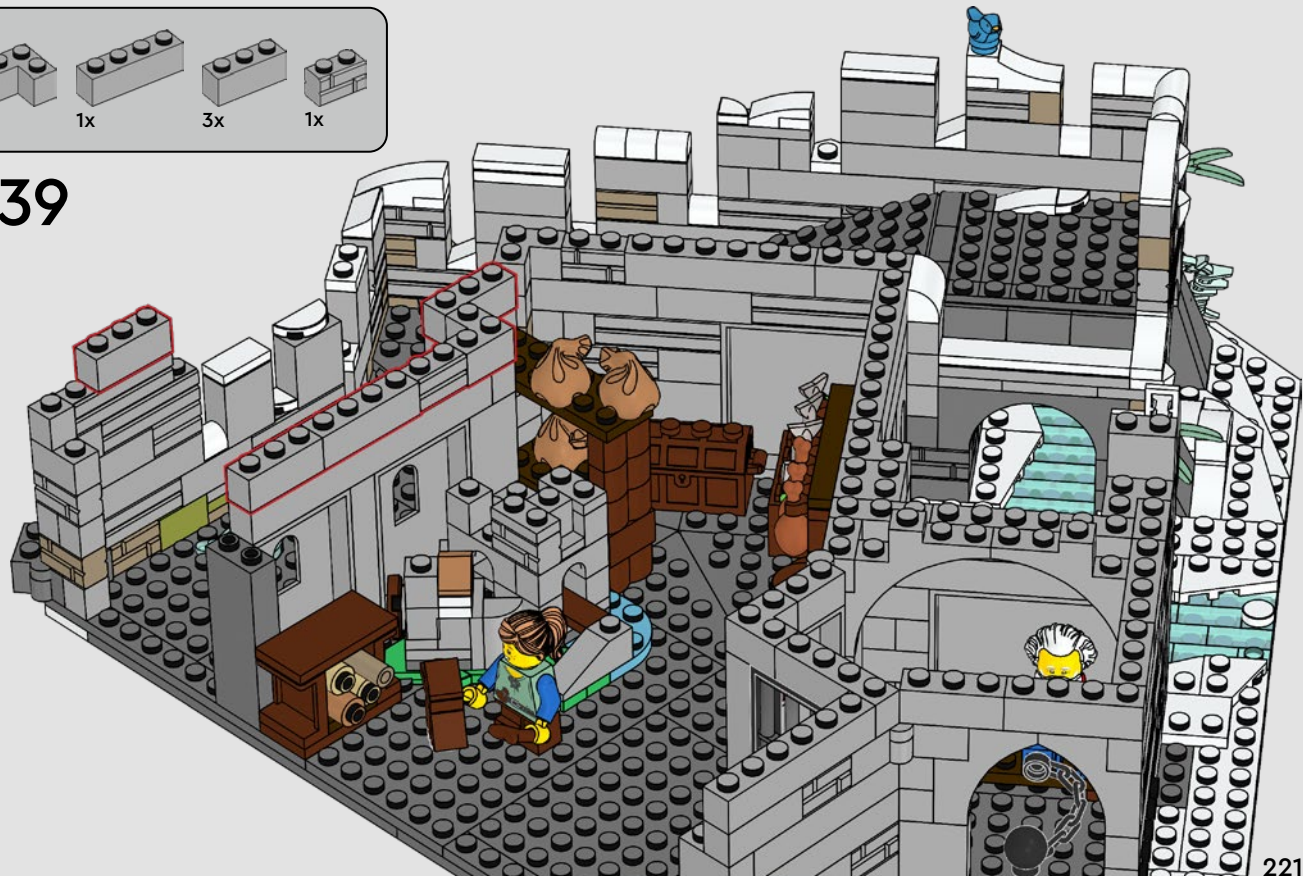

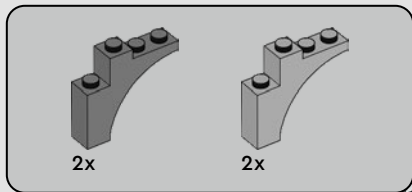

240

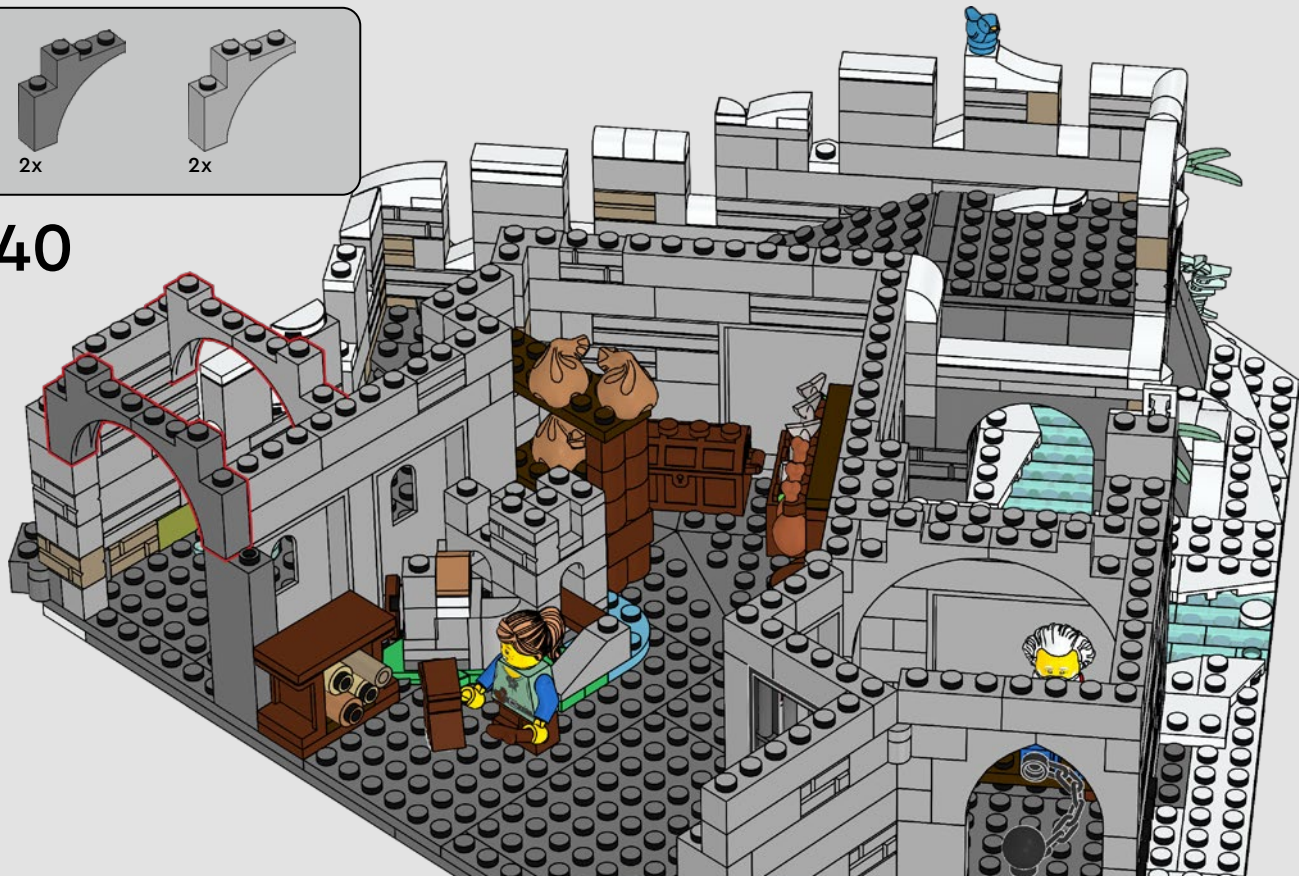



1x



1x

241

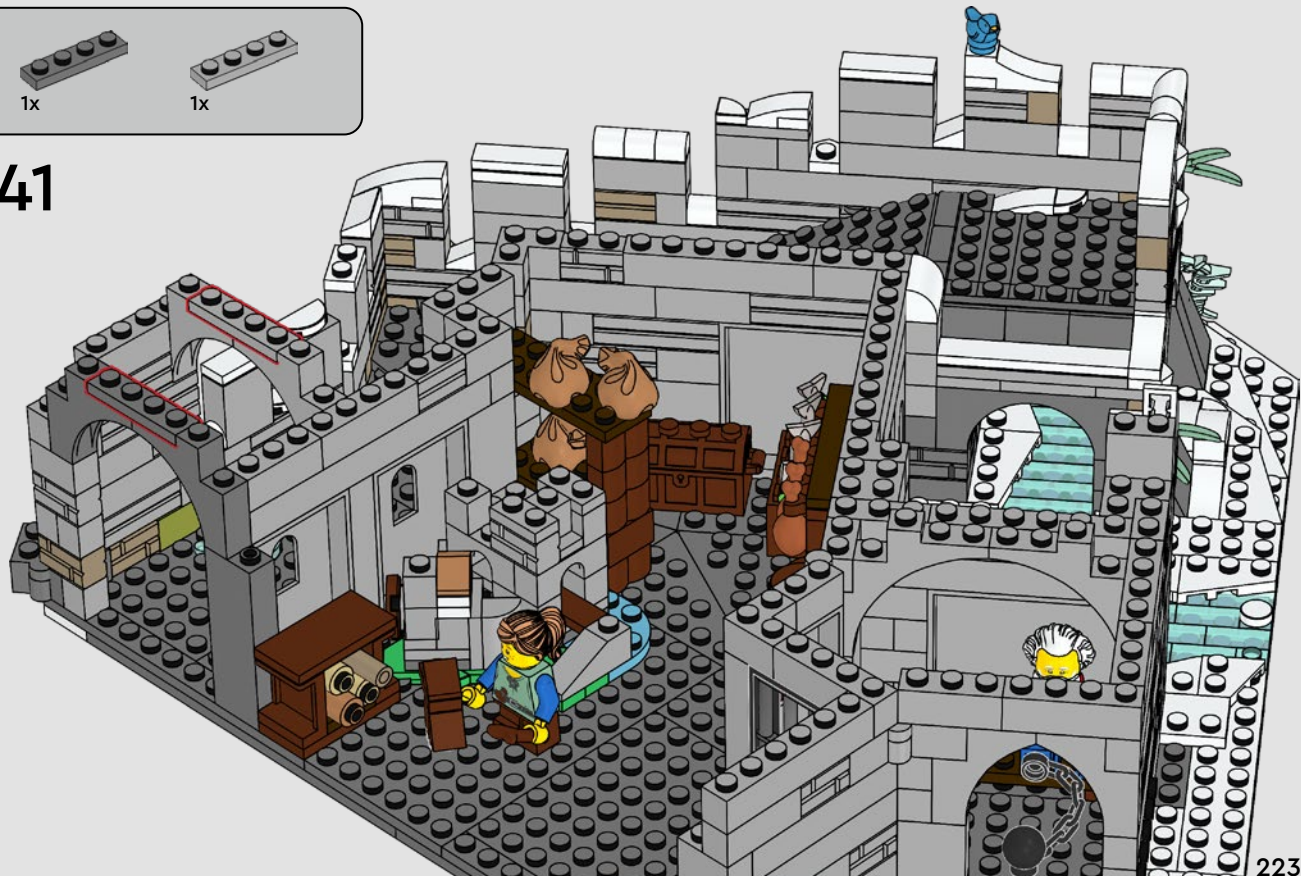



1x



1x

242

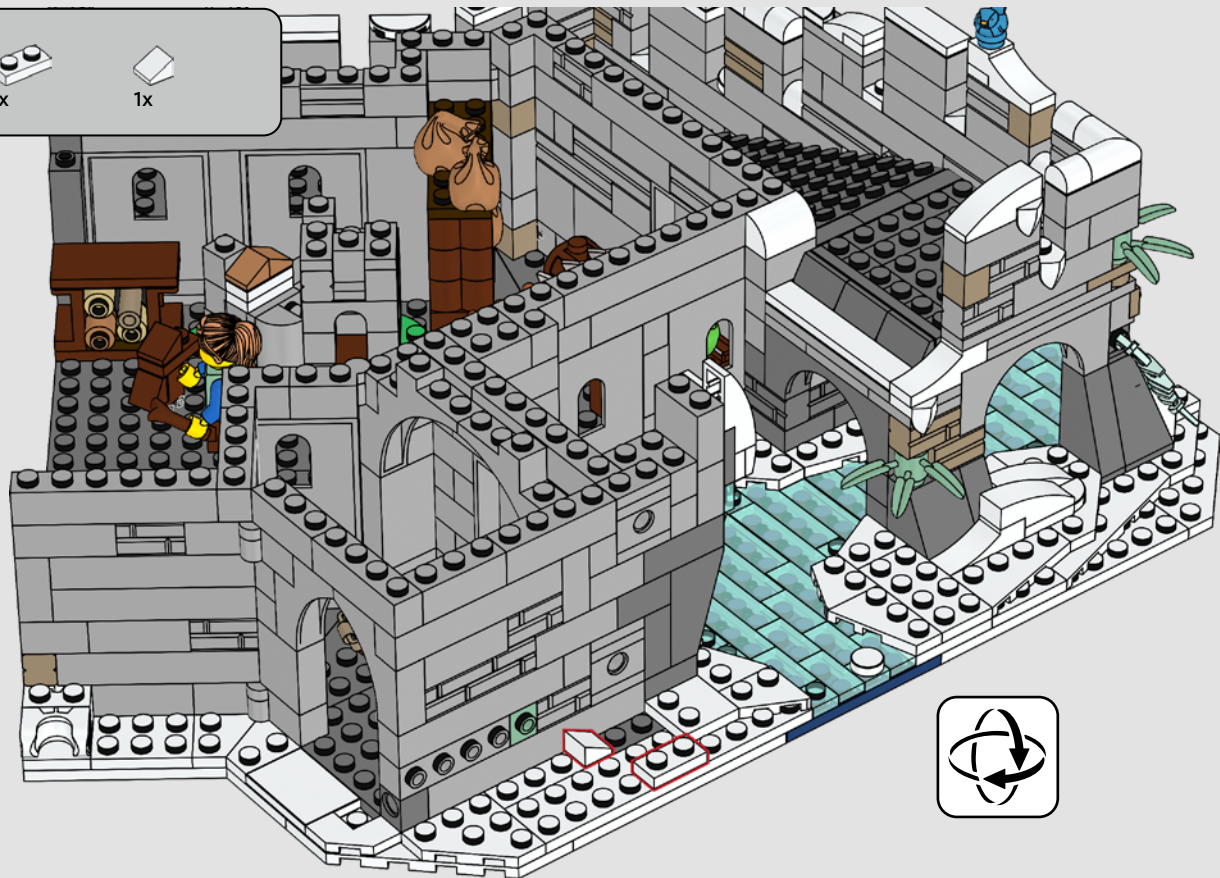

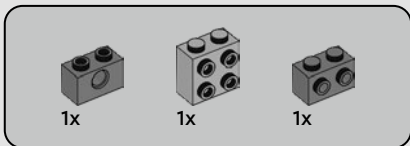
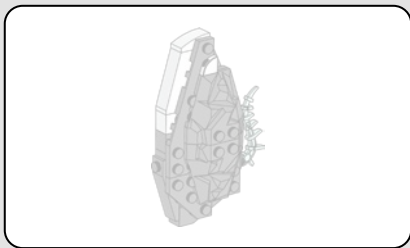

243

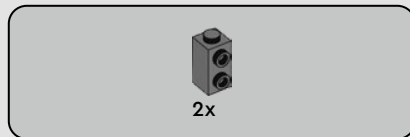
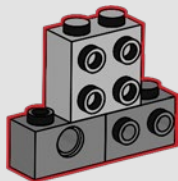

244

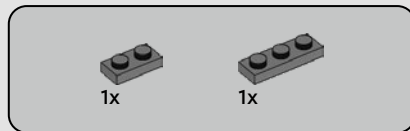
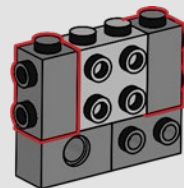

245

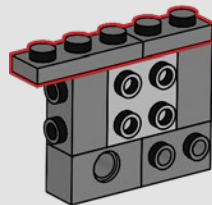

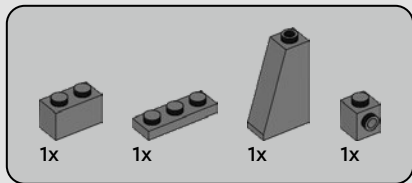

246

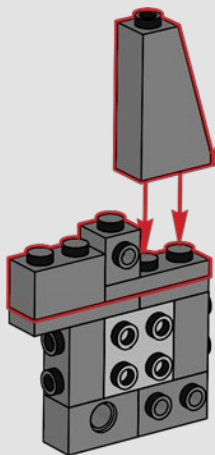

226

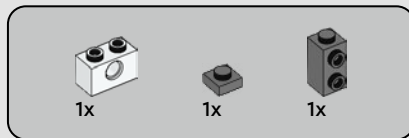

247

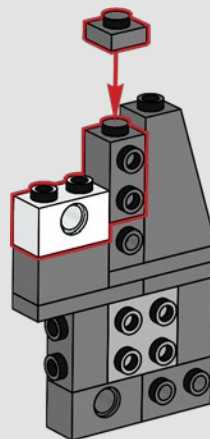

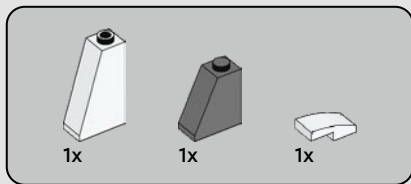

248

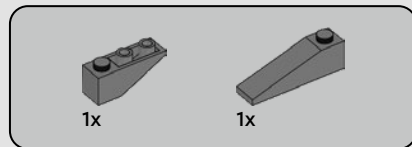
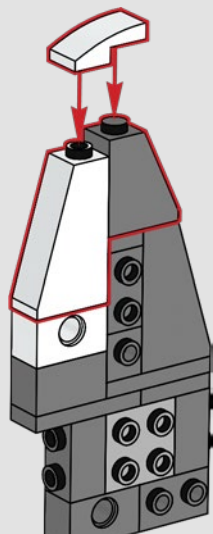

249

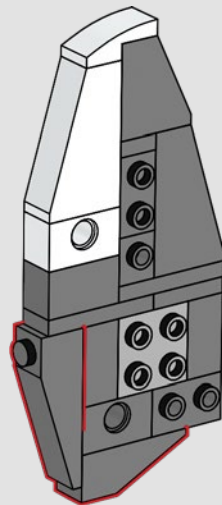

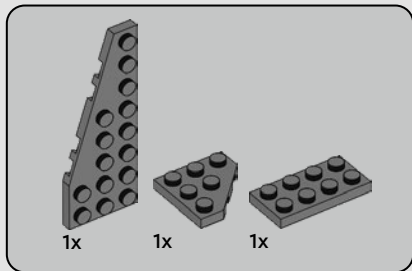

250

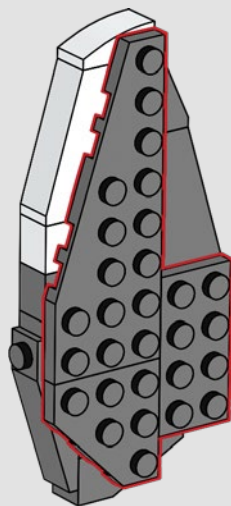

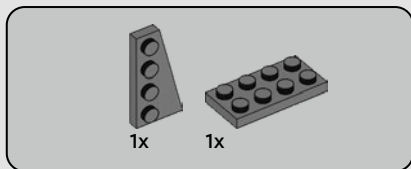

251

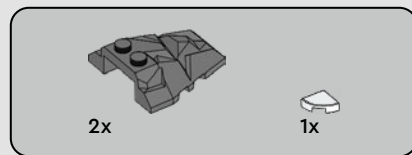
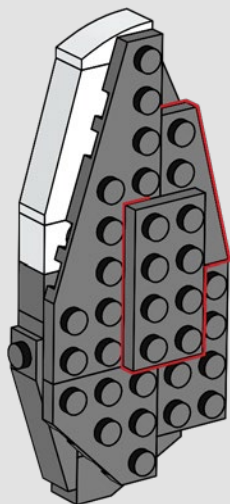
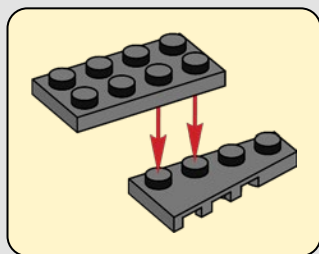

252

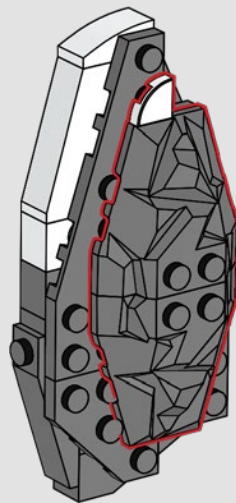

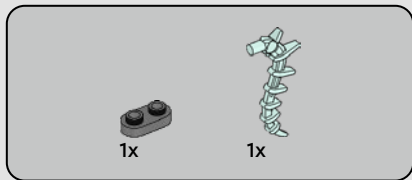

253

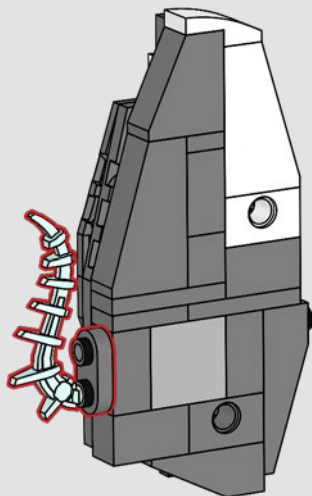

230



254

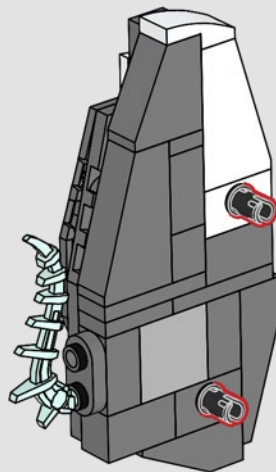

255

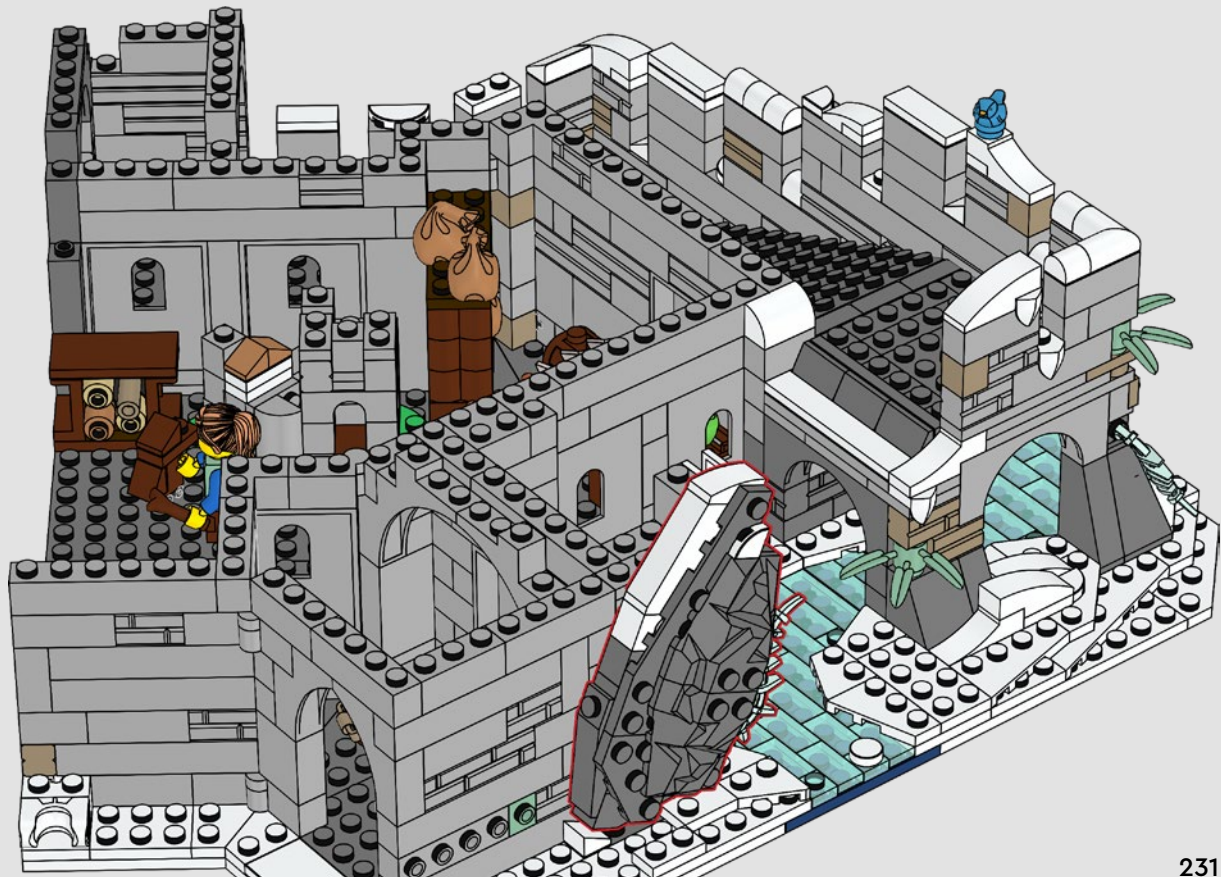



1x



1x

256

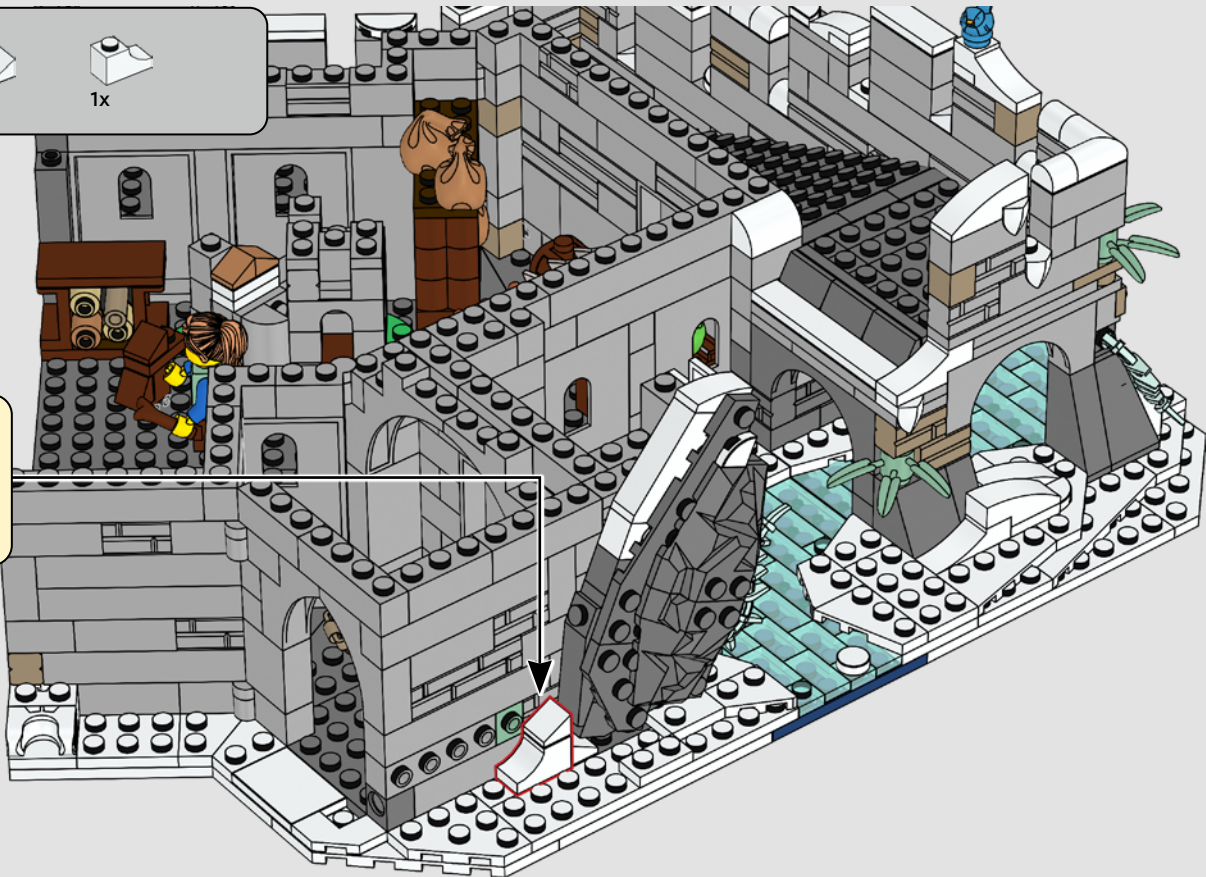
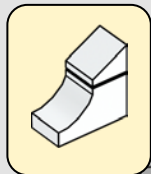



1x



1x



1x

257

1

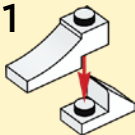

2

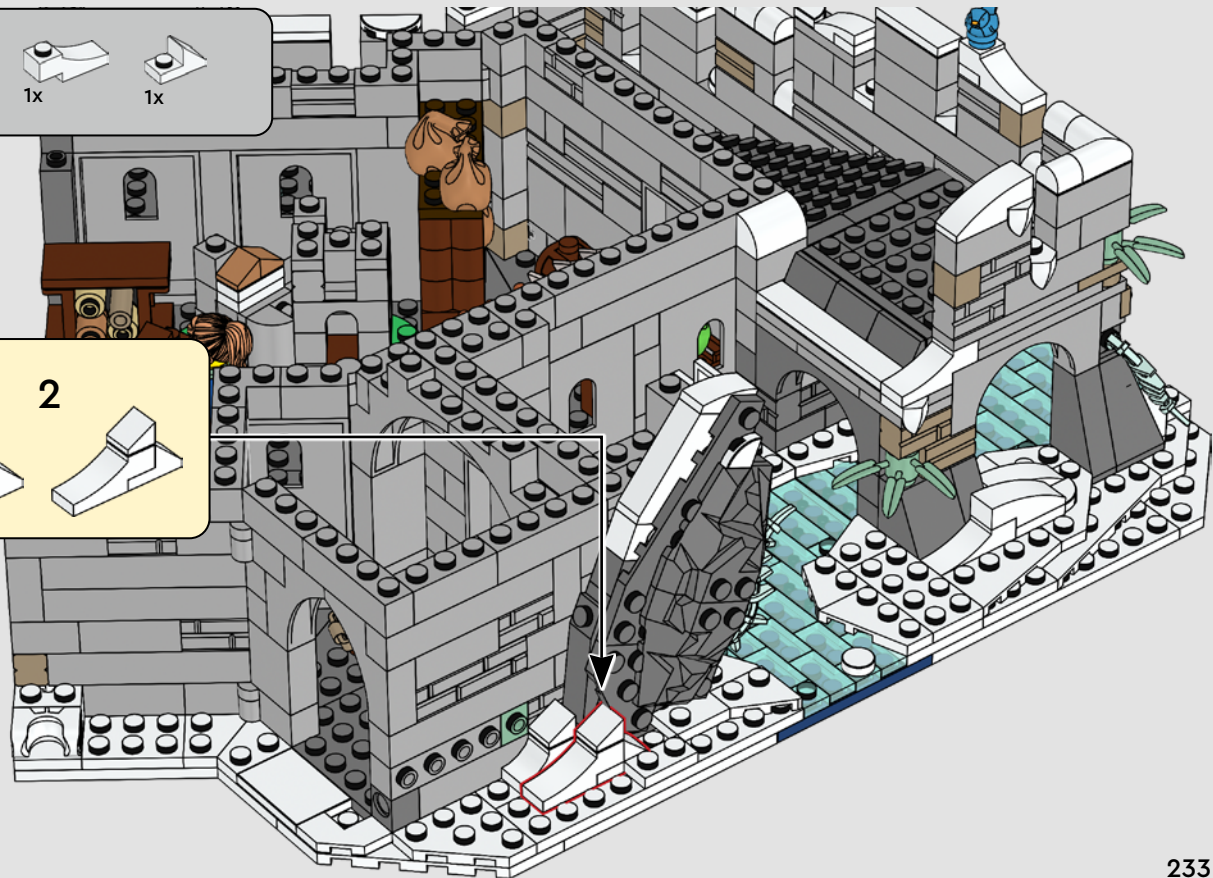
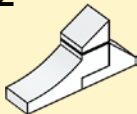

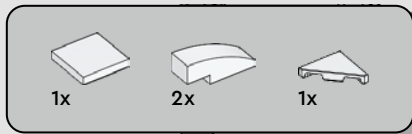

258

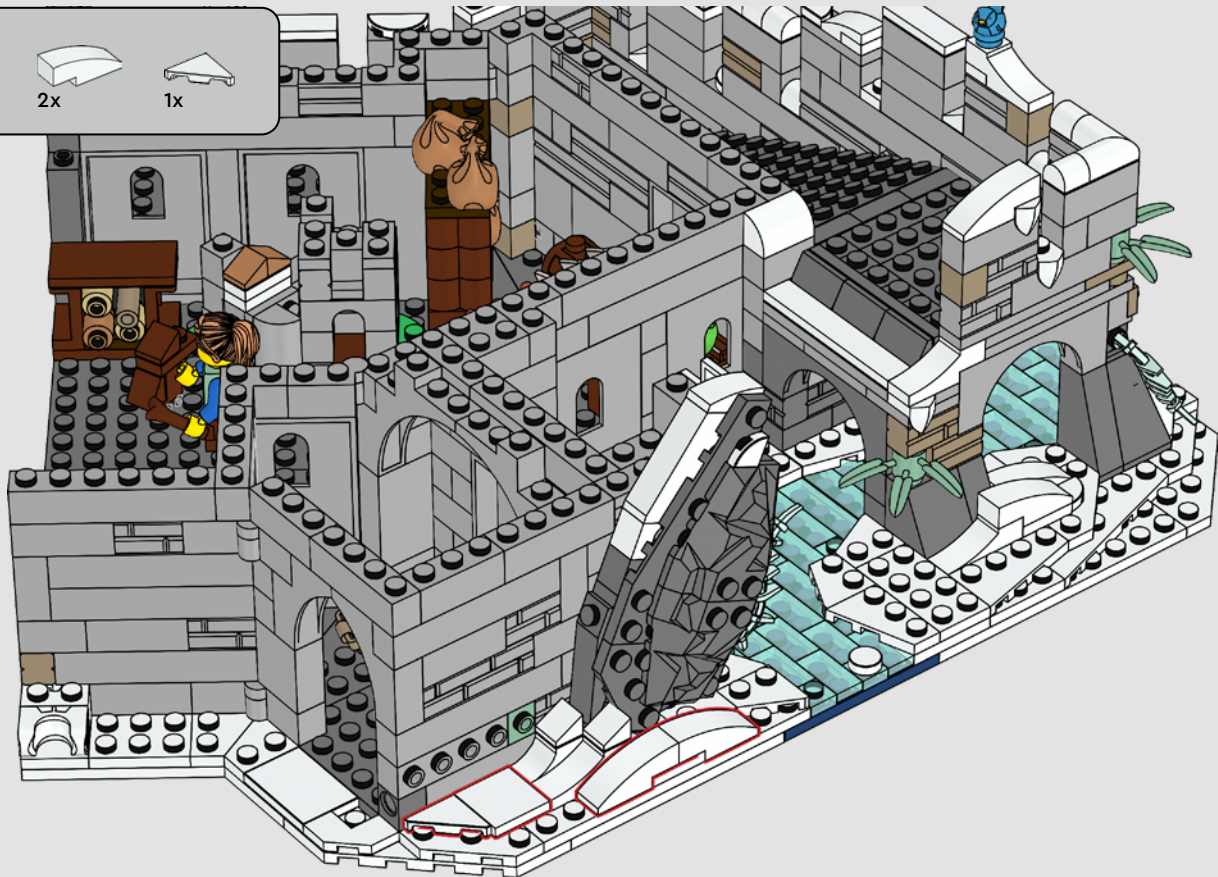



1x



1x

259

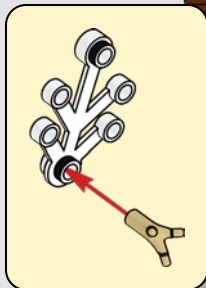

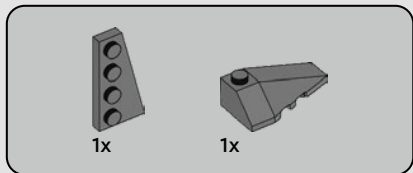

260

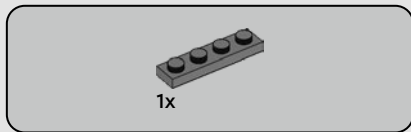
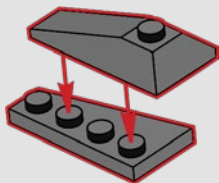

261

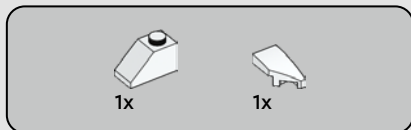
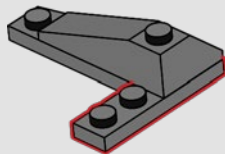

262

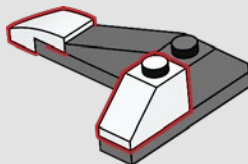

263

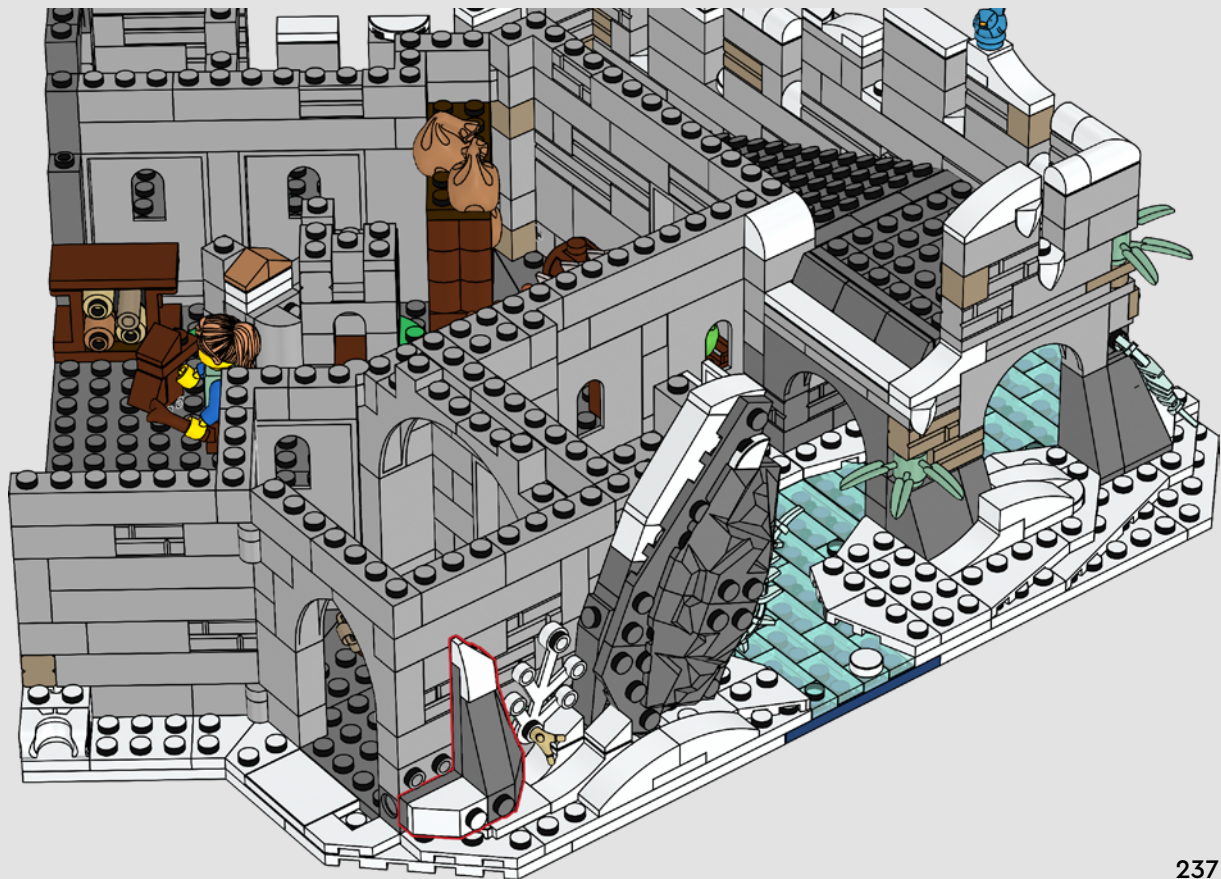

237

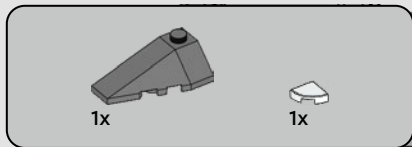

264

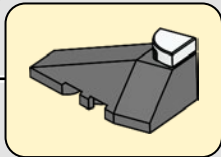
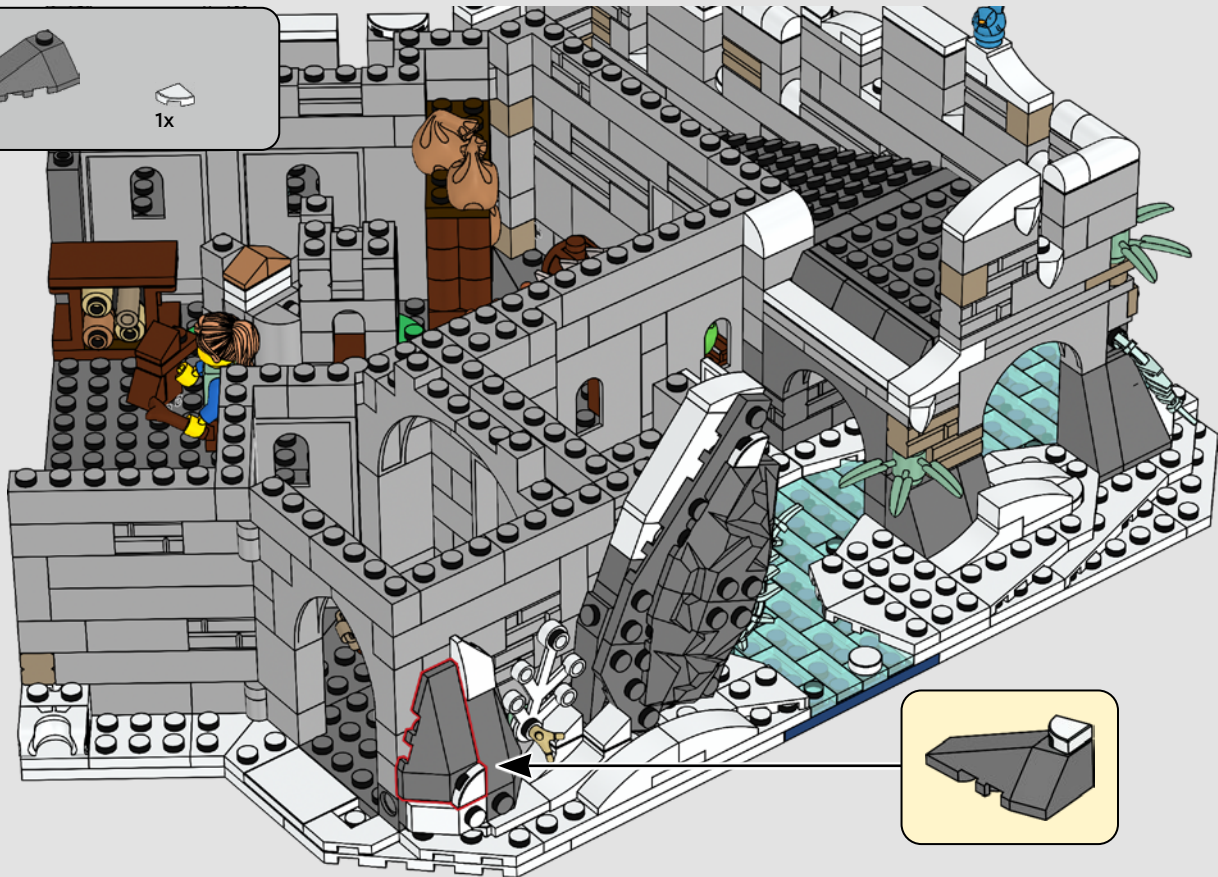

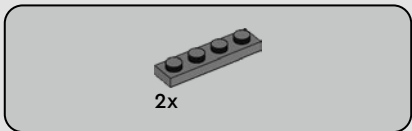
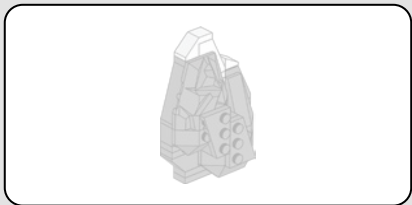

265

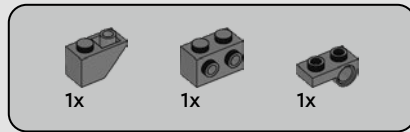
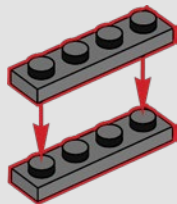

266

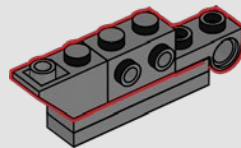



2x

267

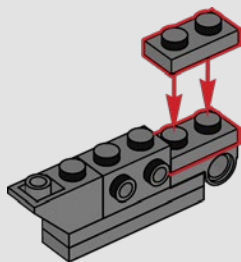

2x

268

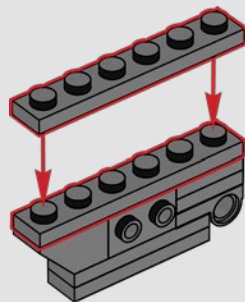

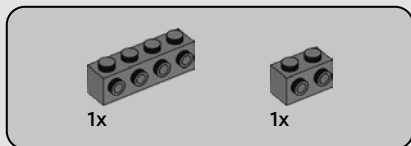

269

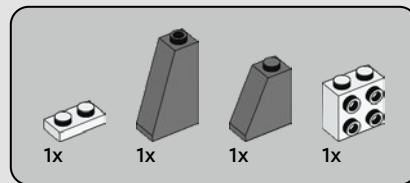
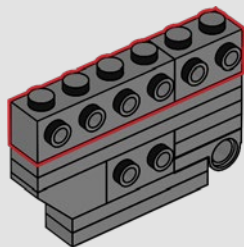

270

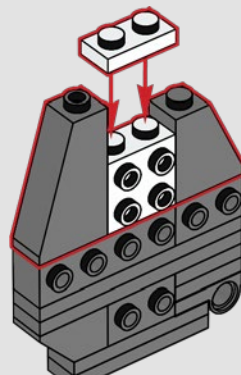

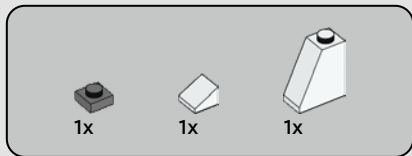

271

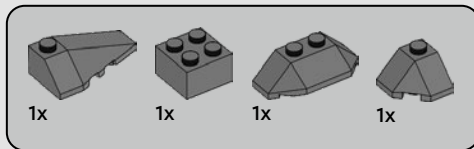
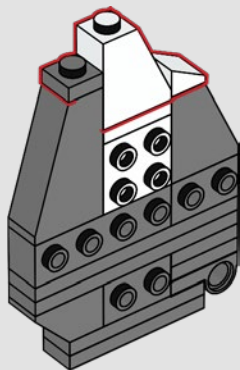

272

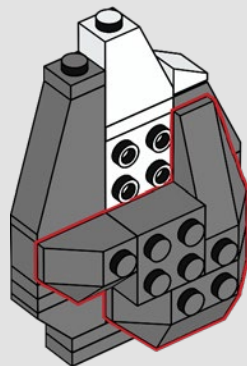

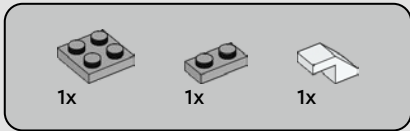

273

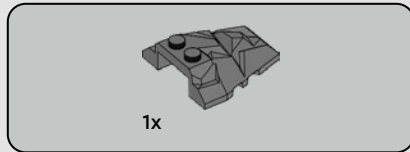
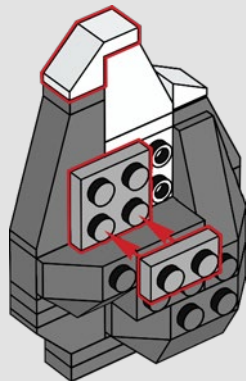

274

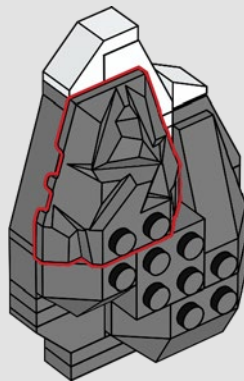



2x

275

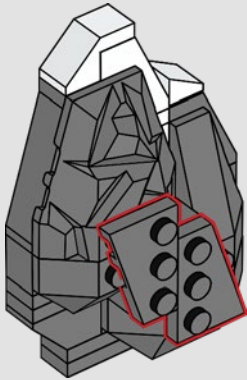

1x



276

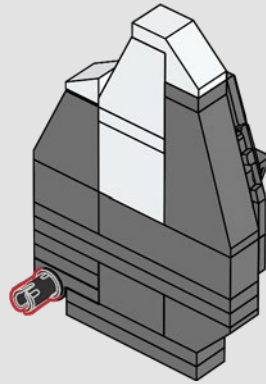

277

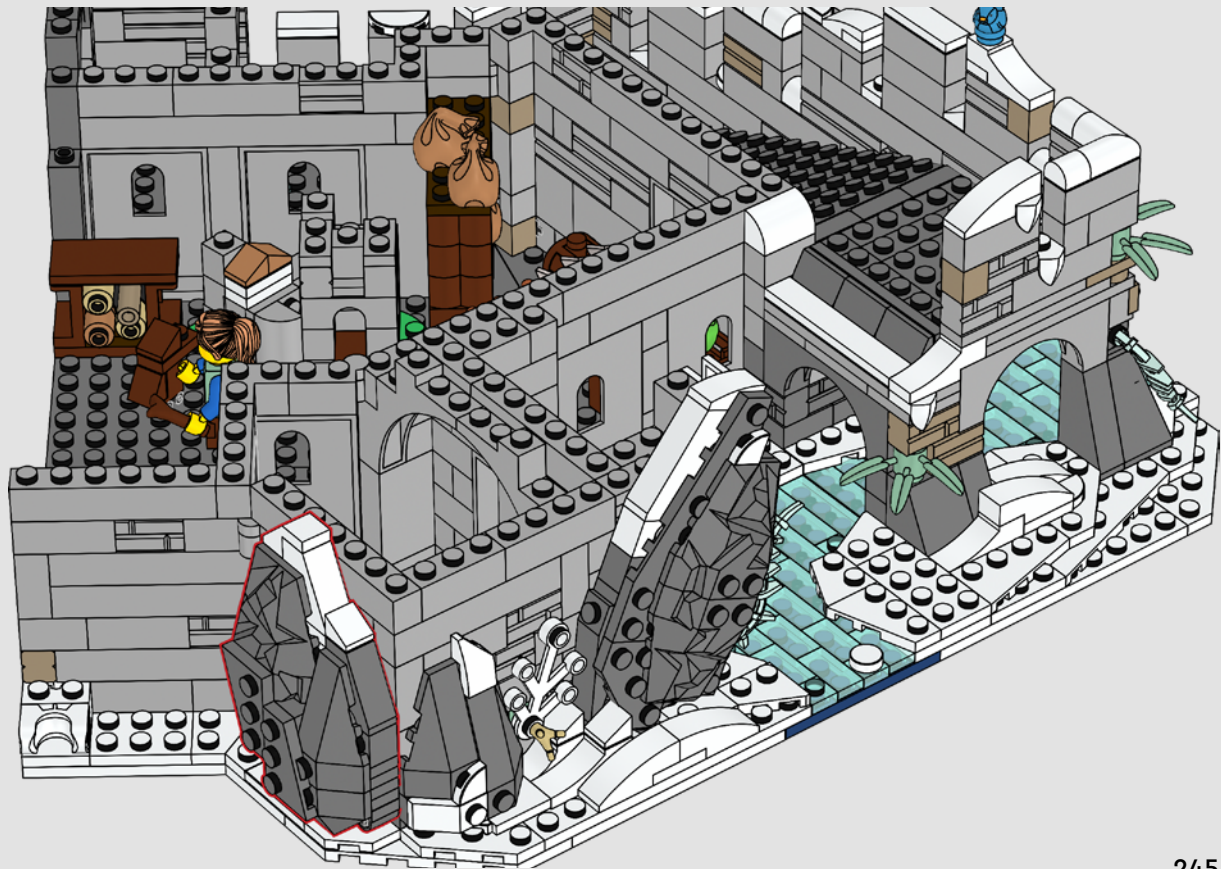



1x

278

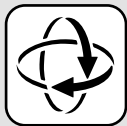
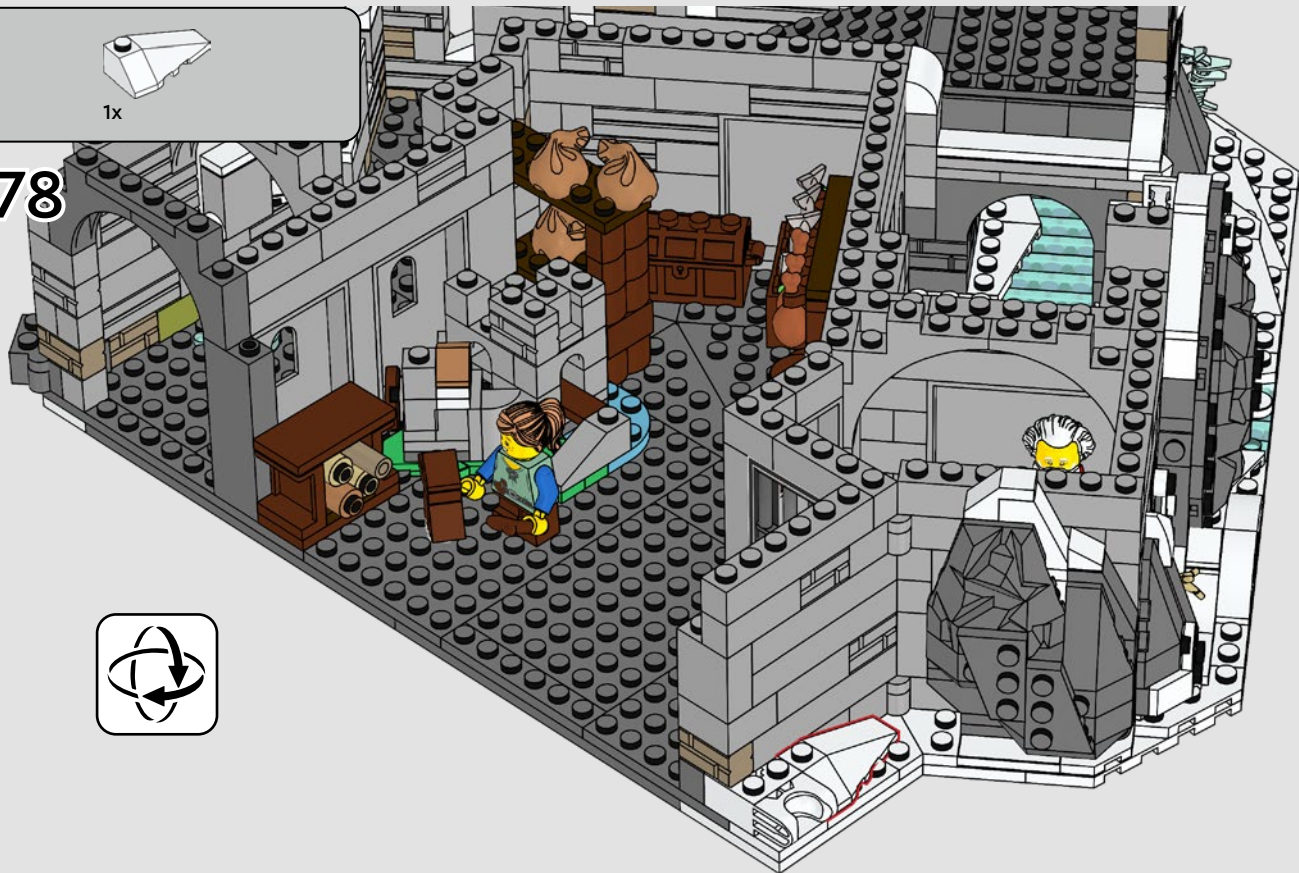

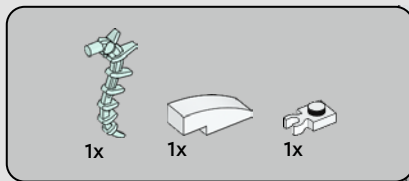

279

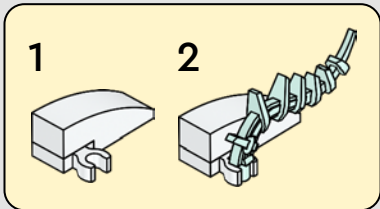
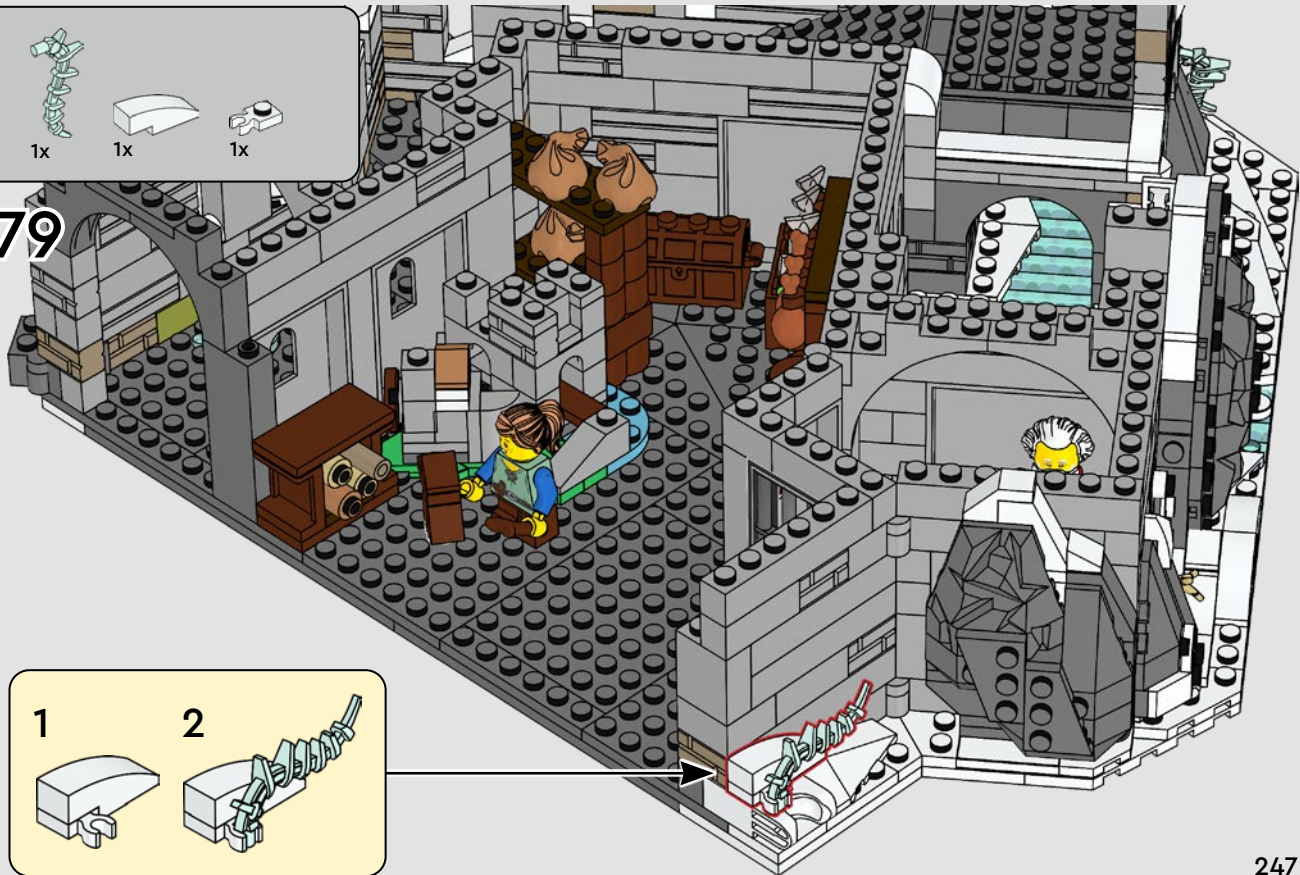

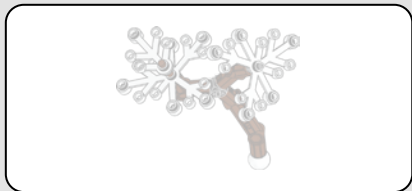

280

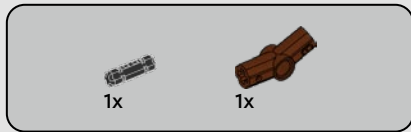

281





282



283

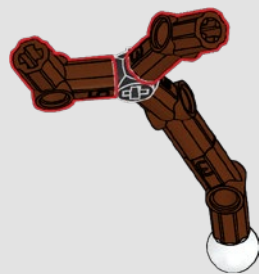



284

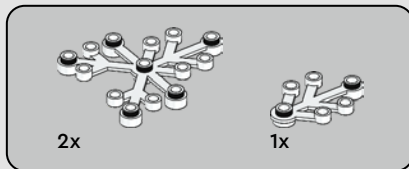
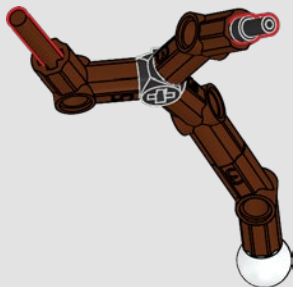

285



286



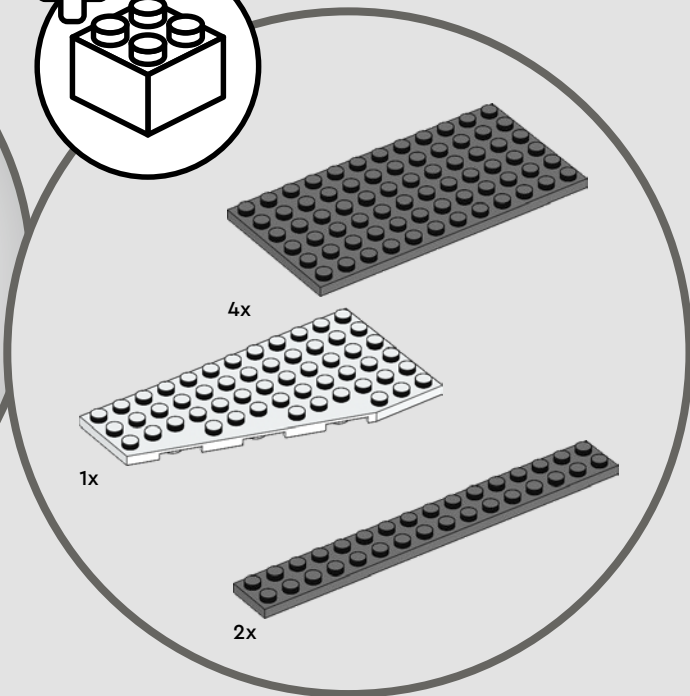
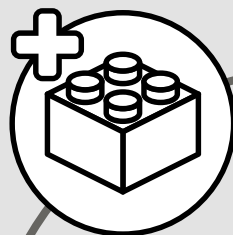
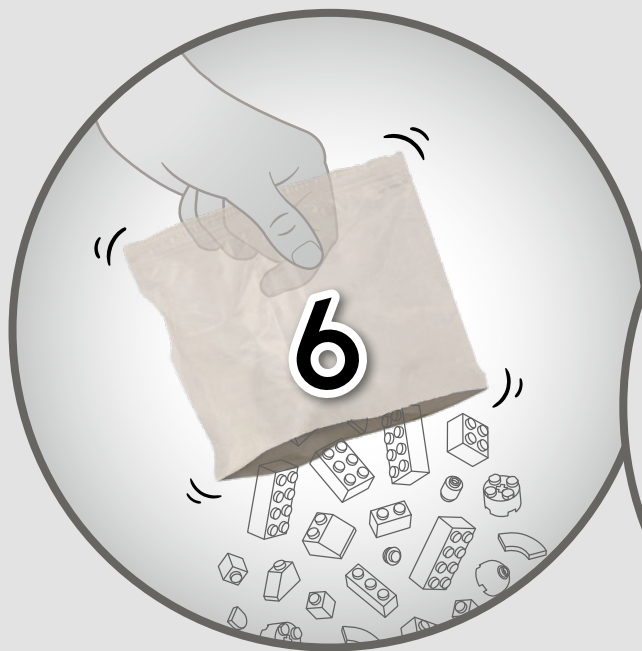

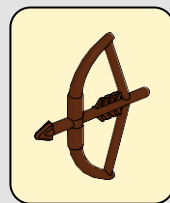
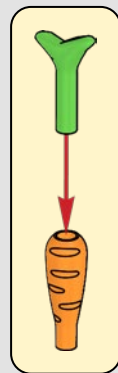
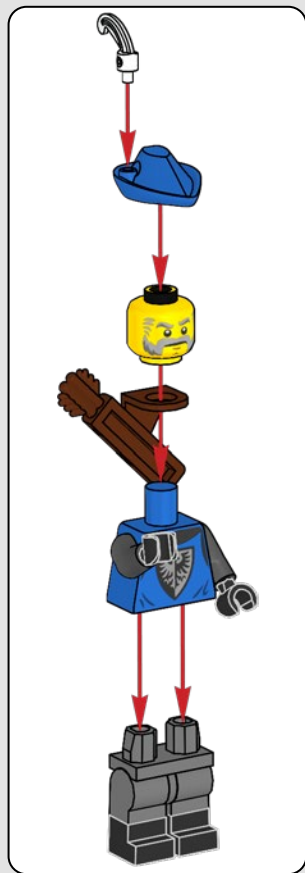

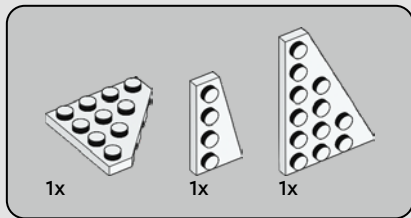
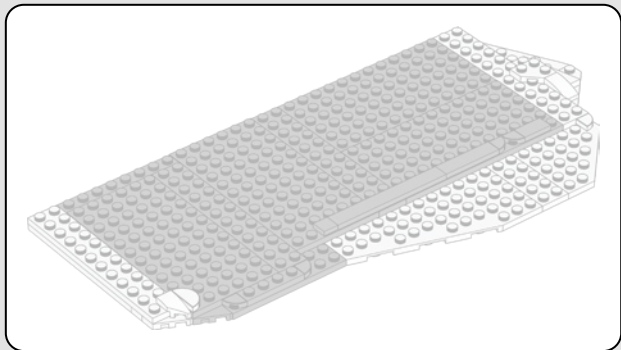

287

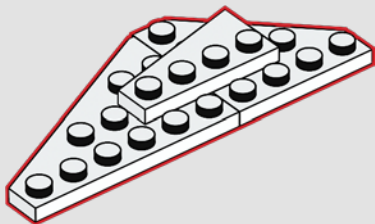

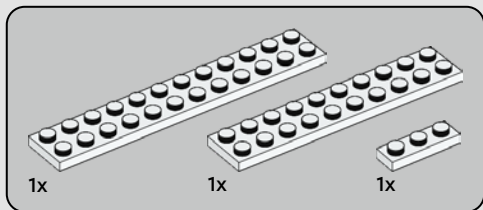

288

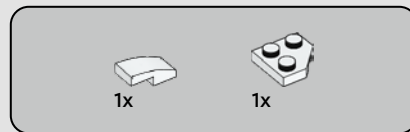
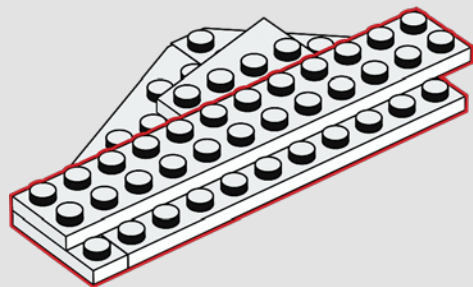

289

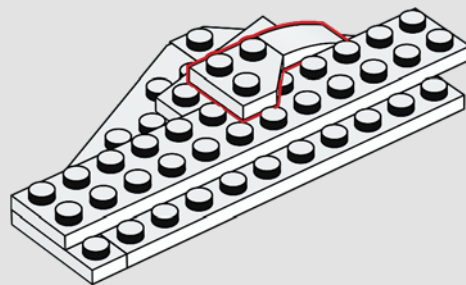

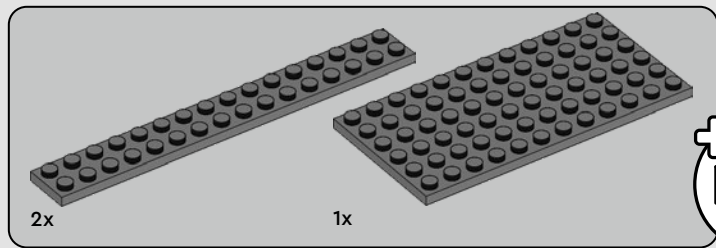

290

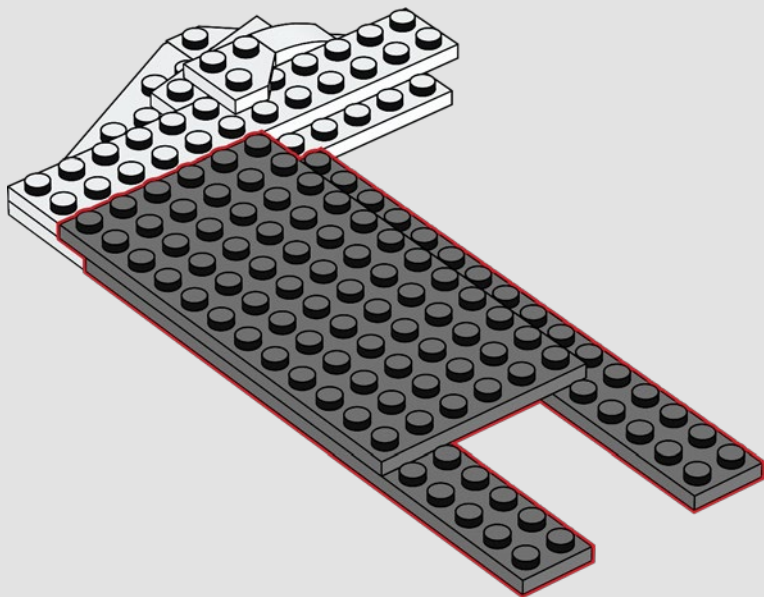

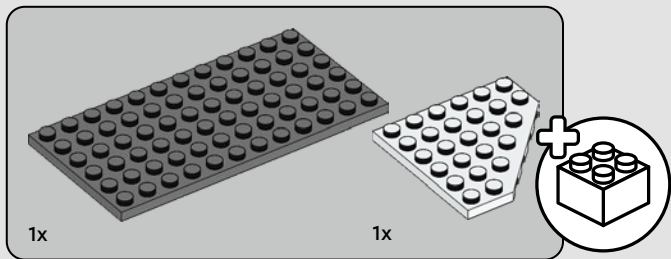

291

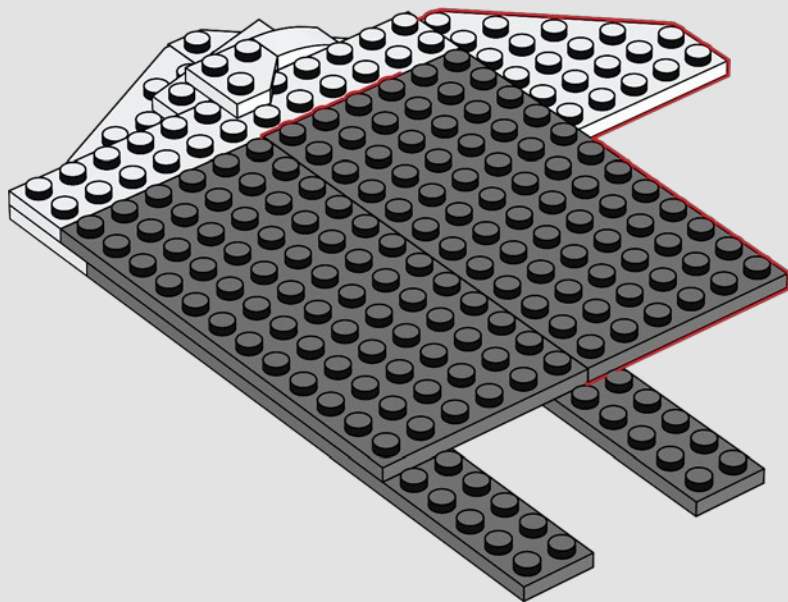

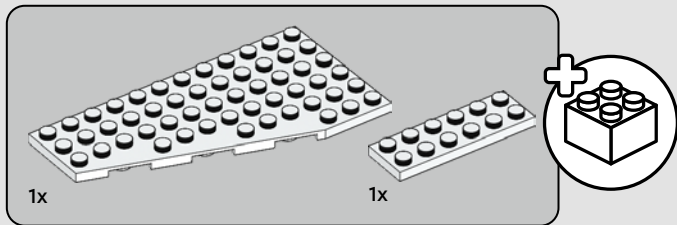

292

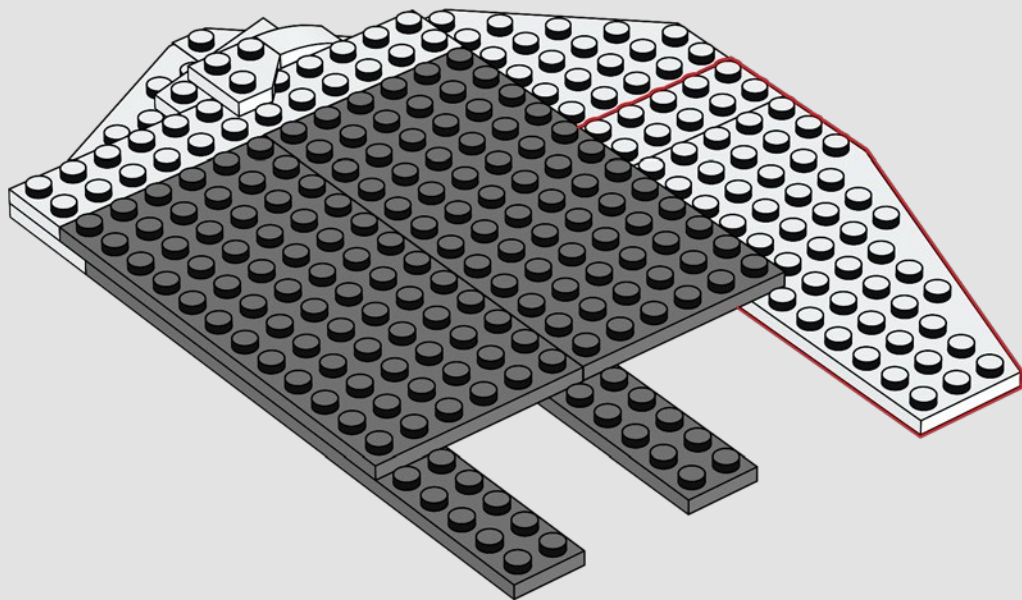

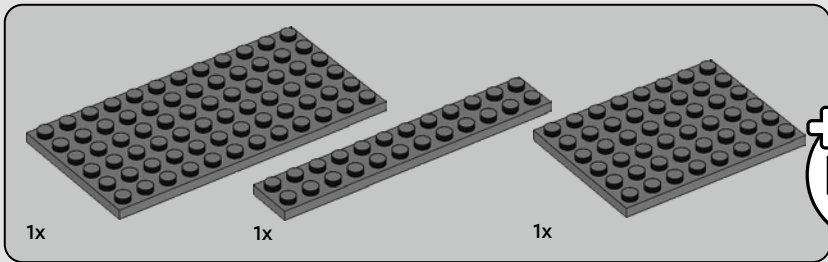

293

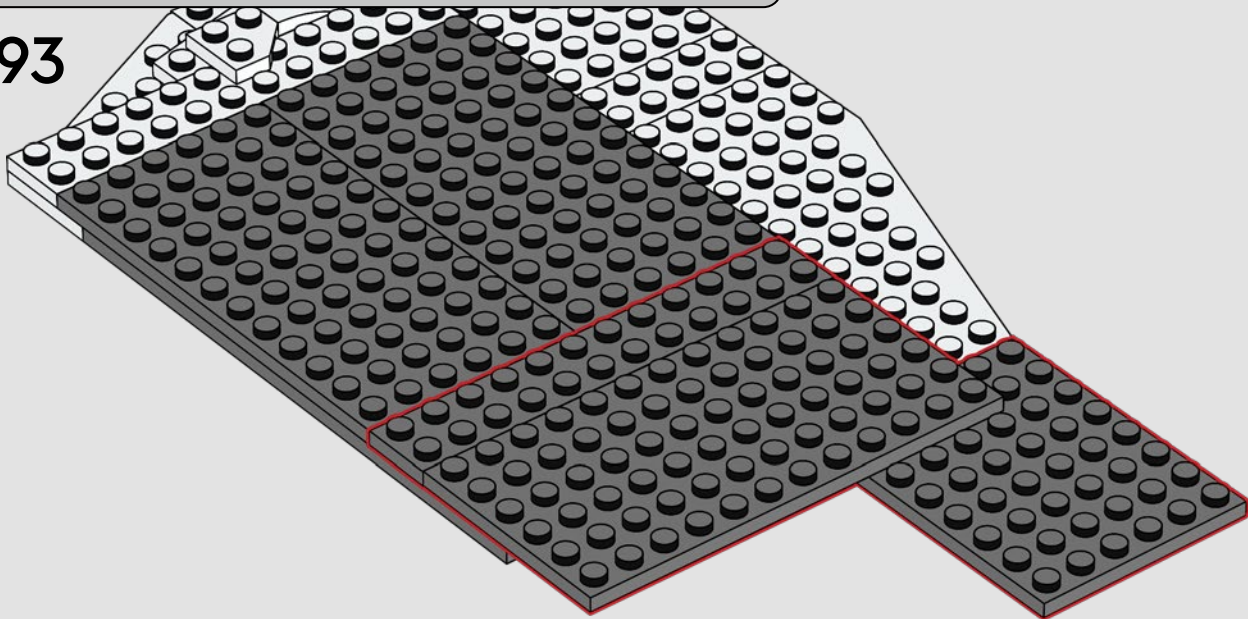

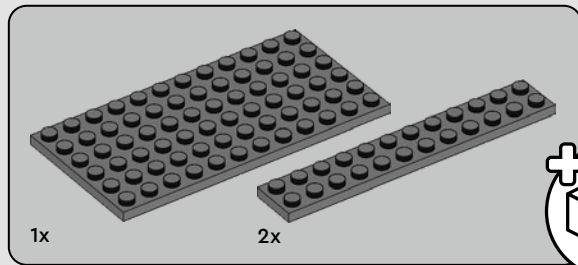

294

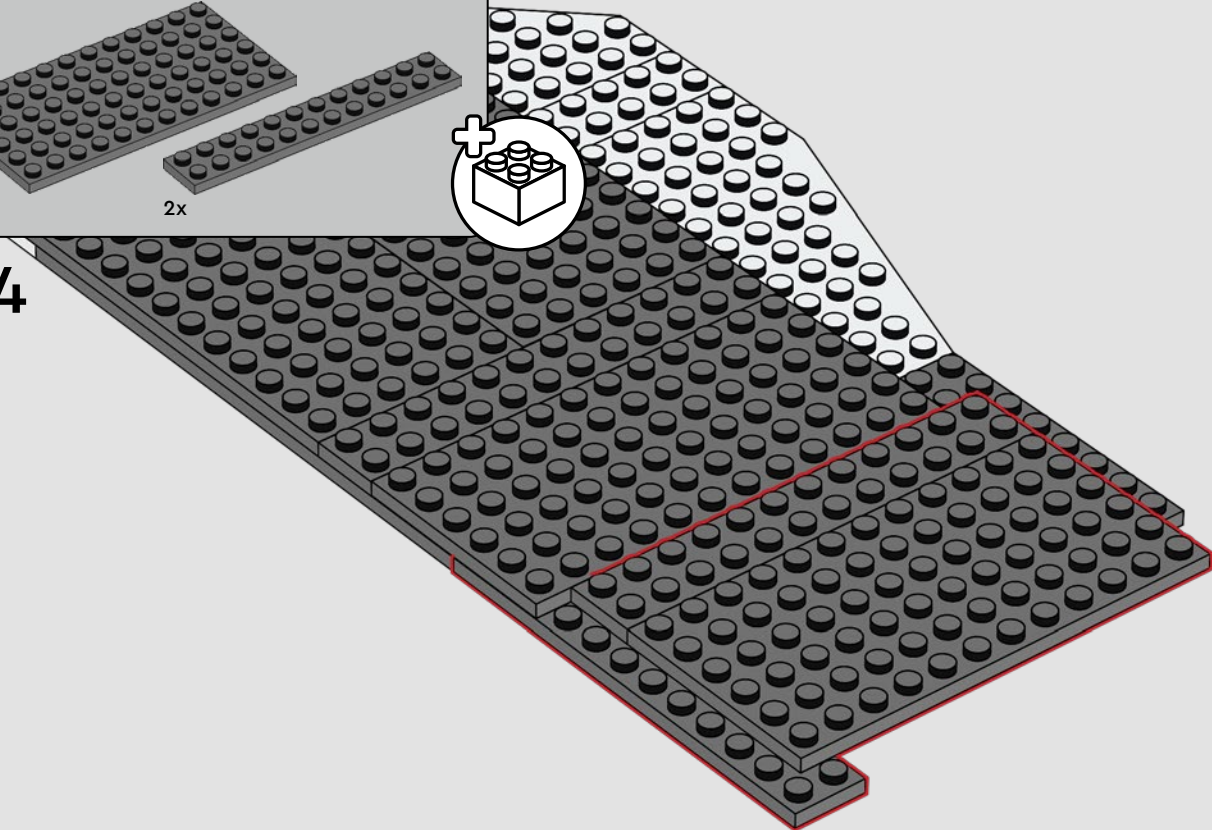

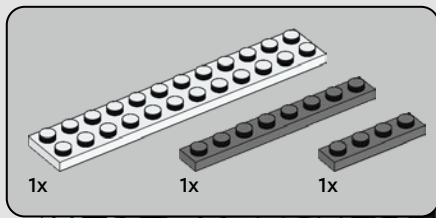

295

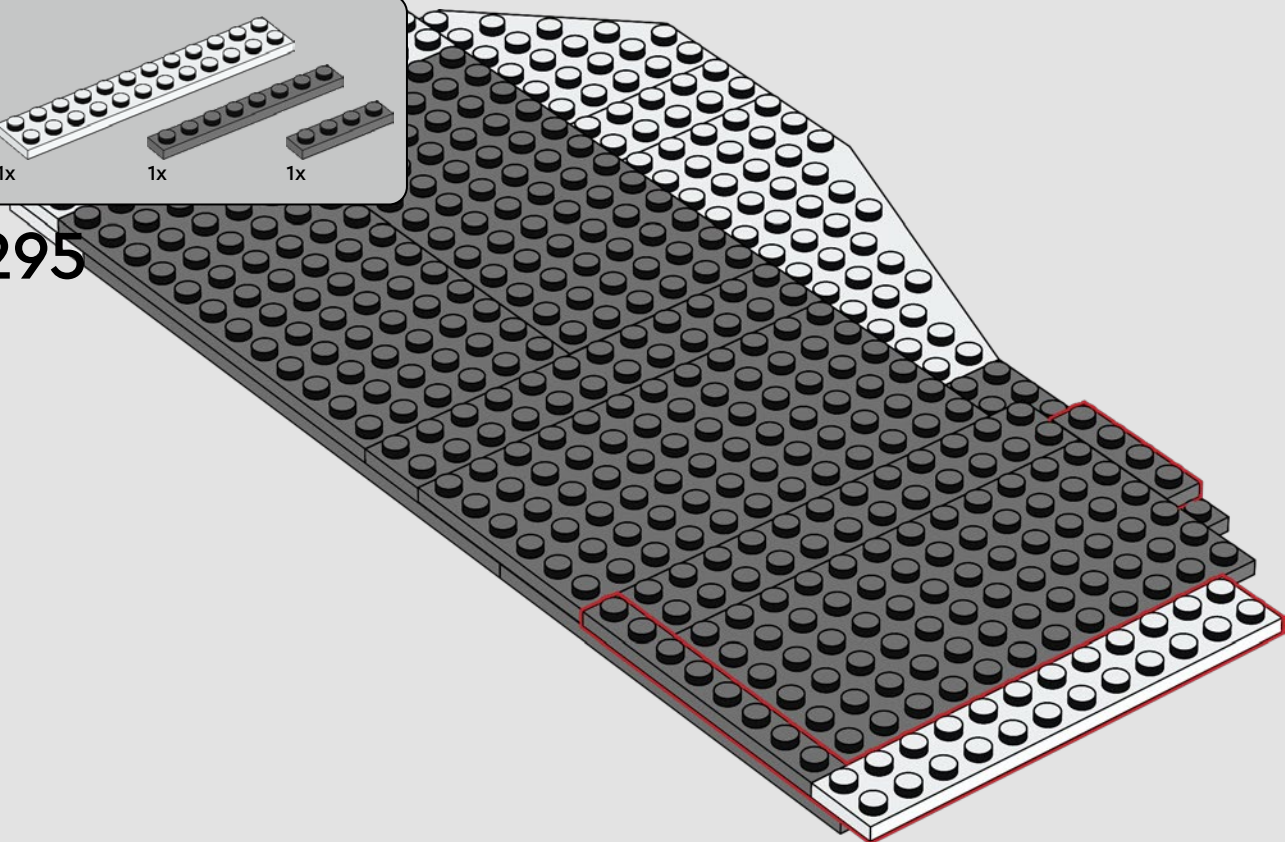

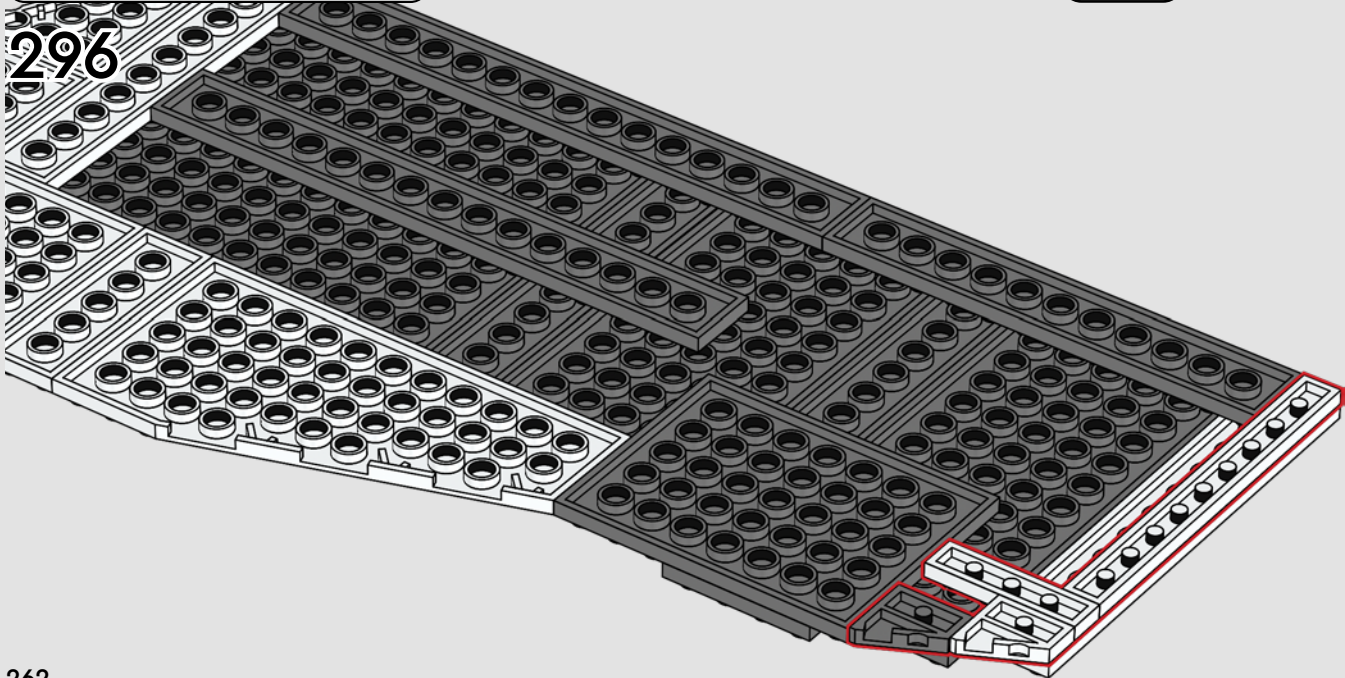
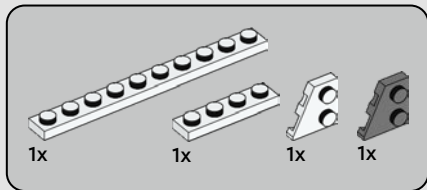

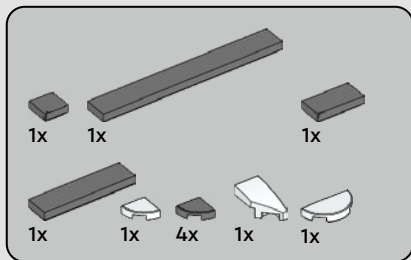

297

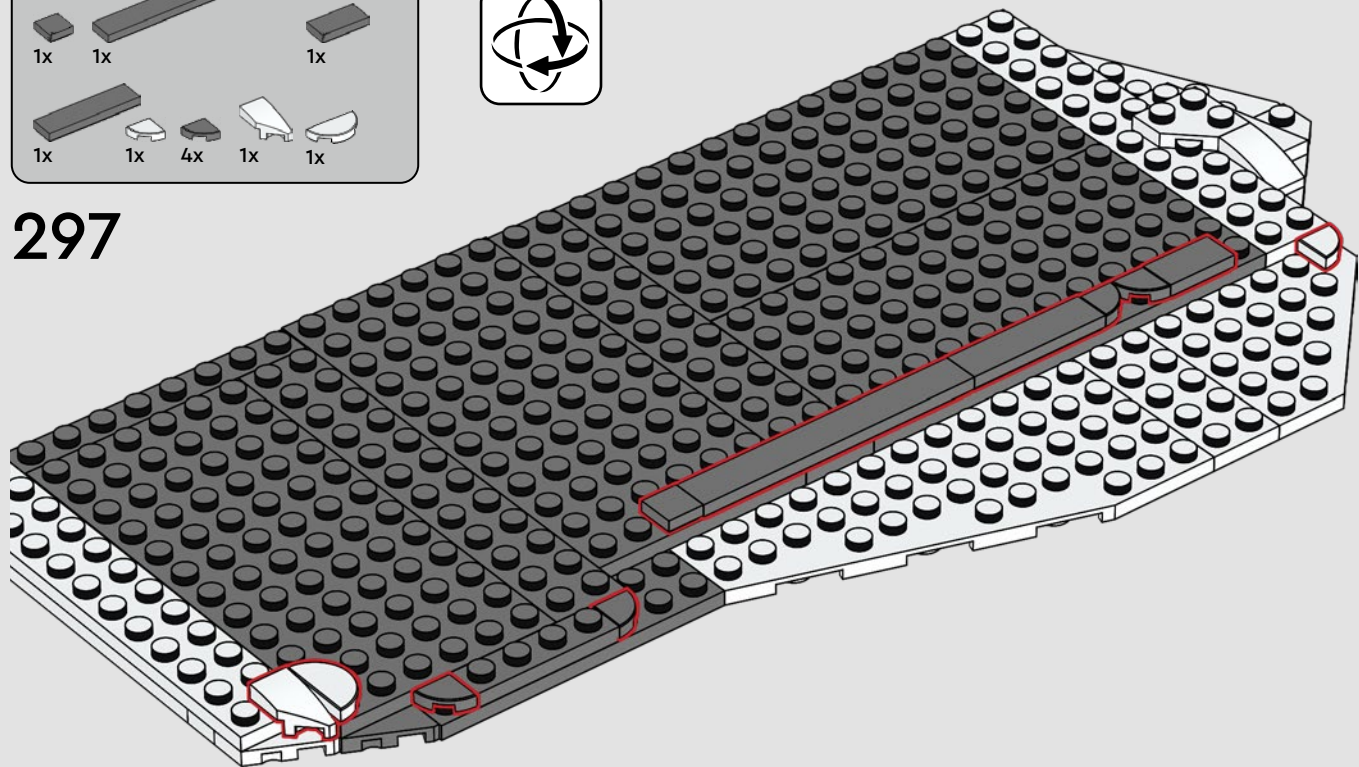

298

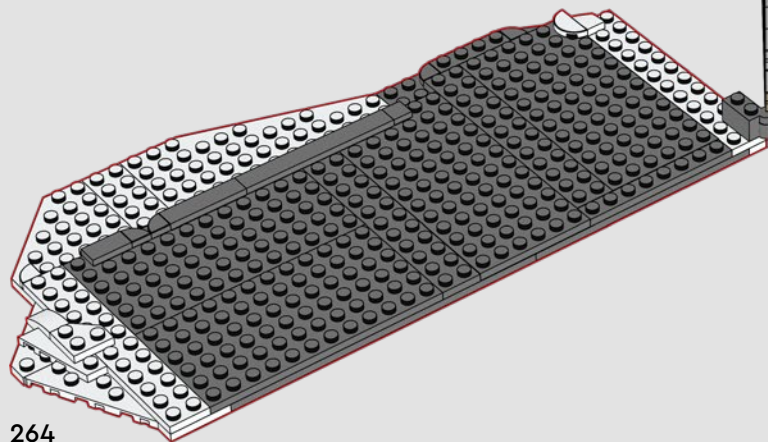
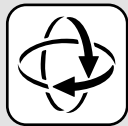

264



1x



1x

299

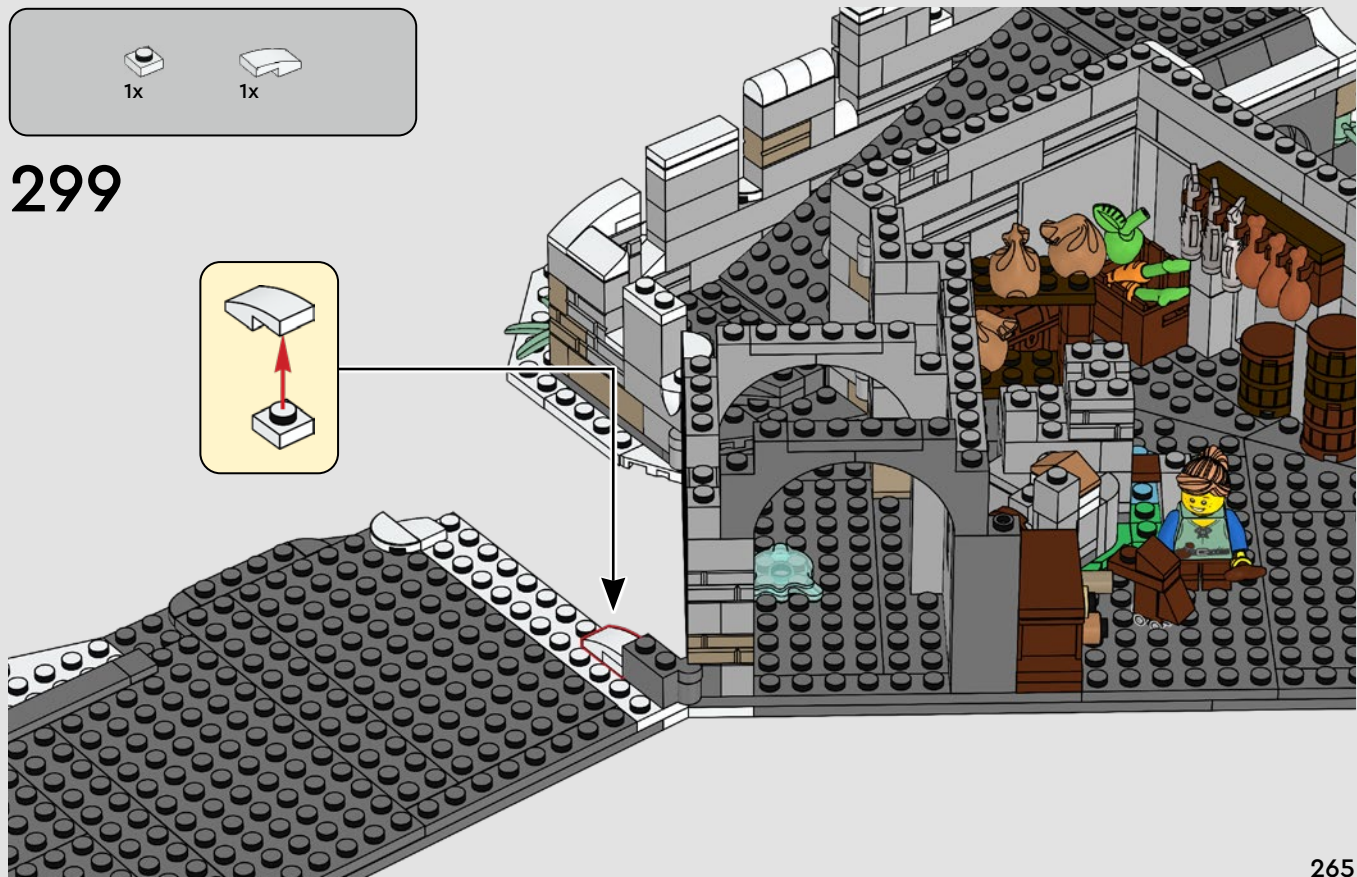
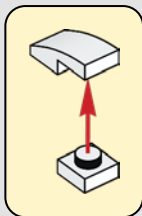



1x



2x

300

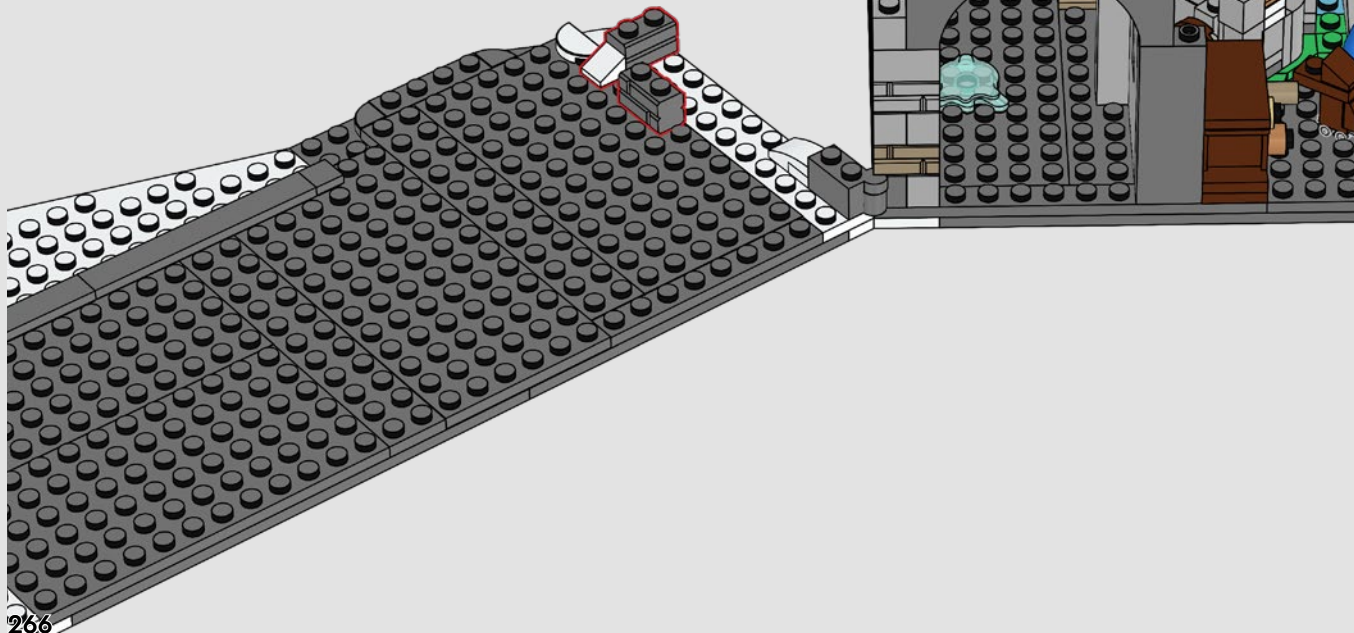

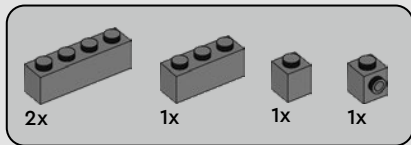

301

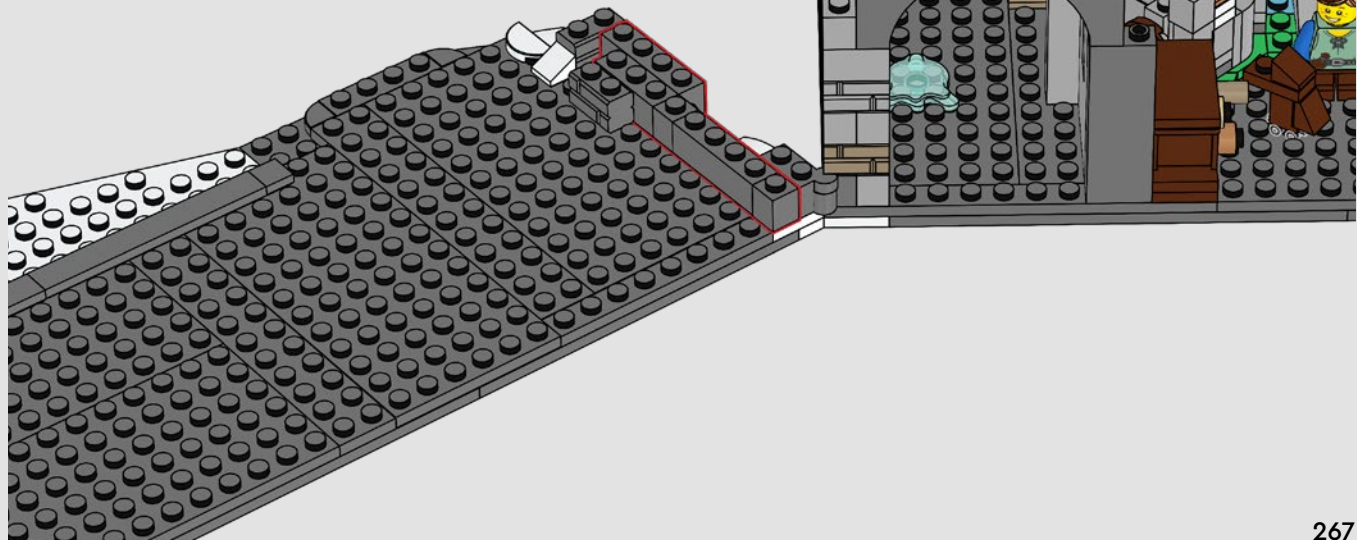

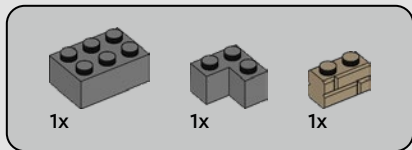

302

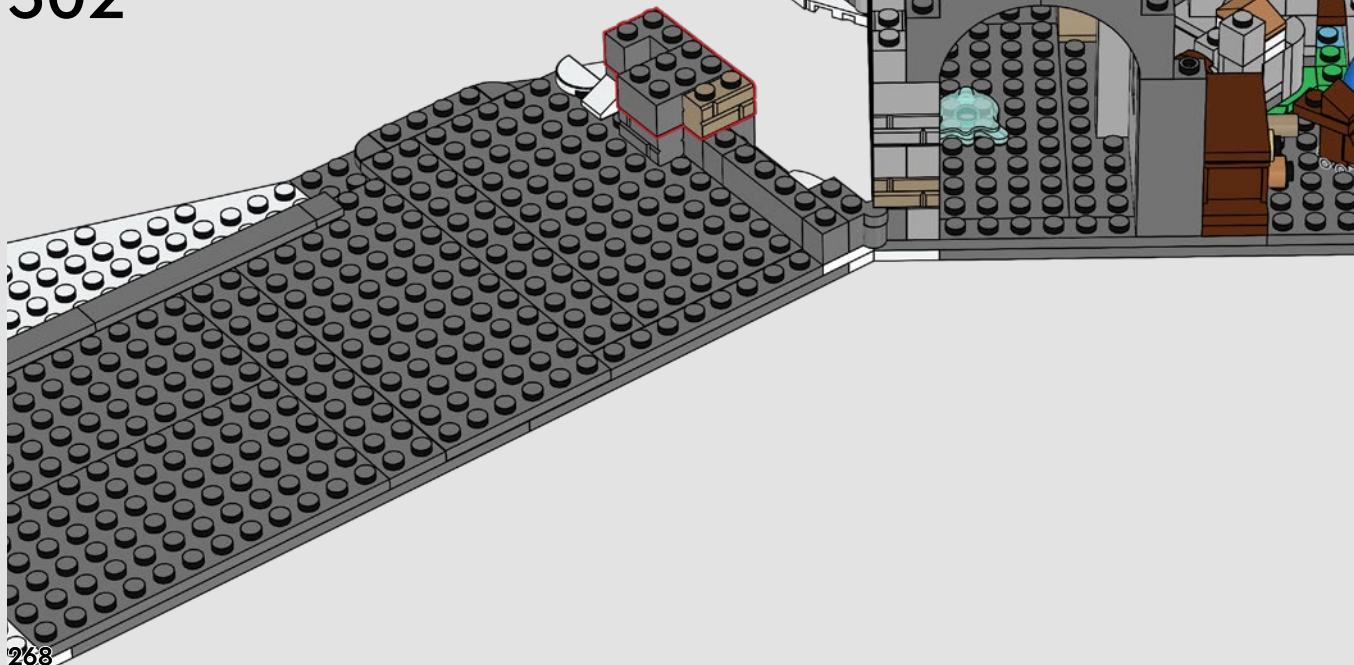

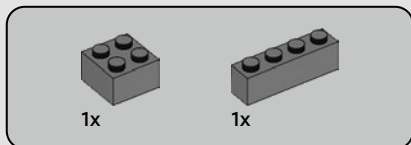

303

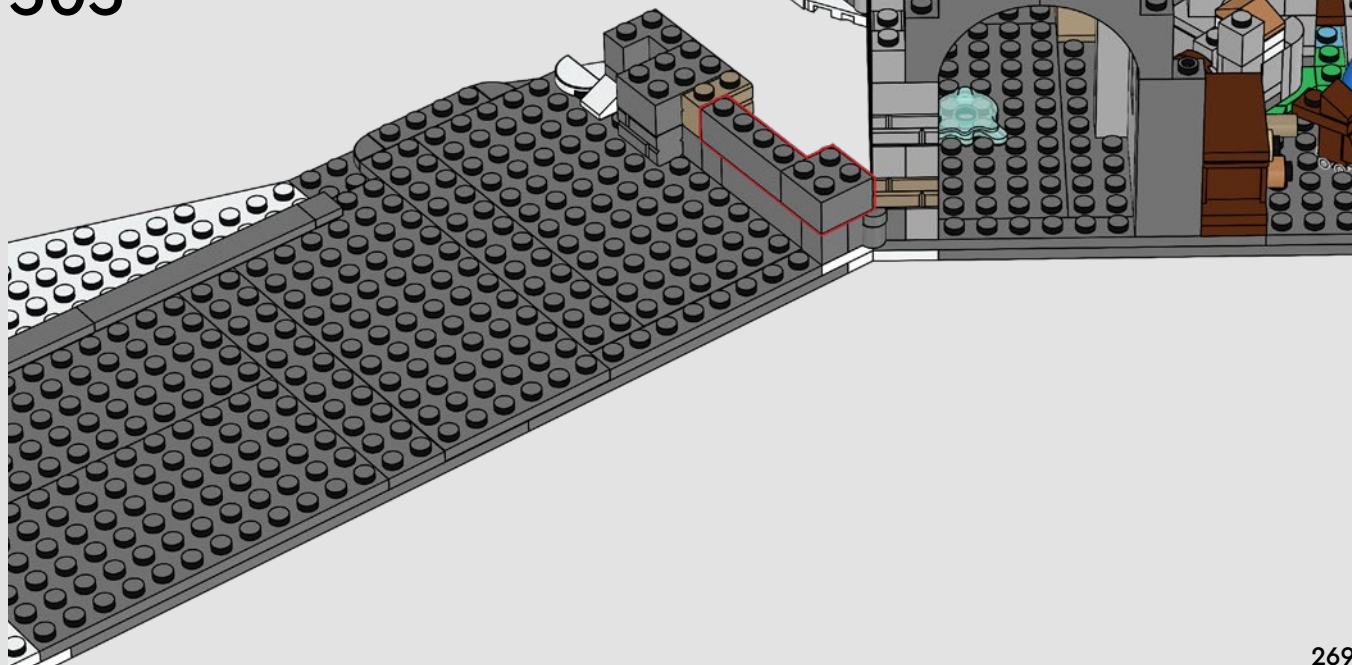

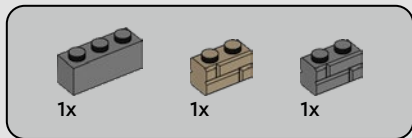

304

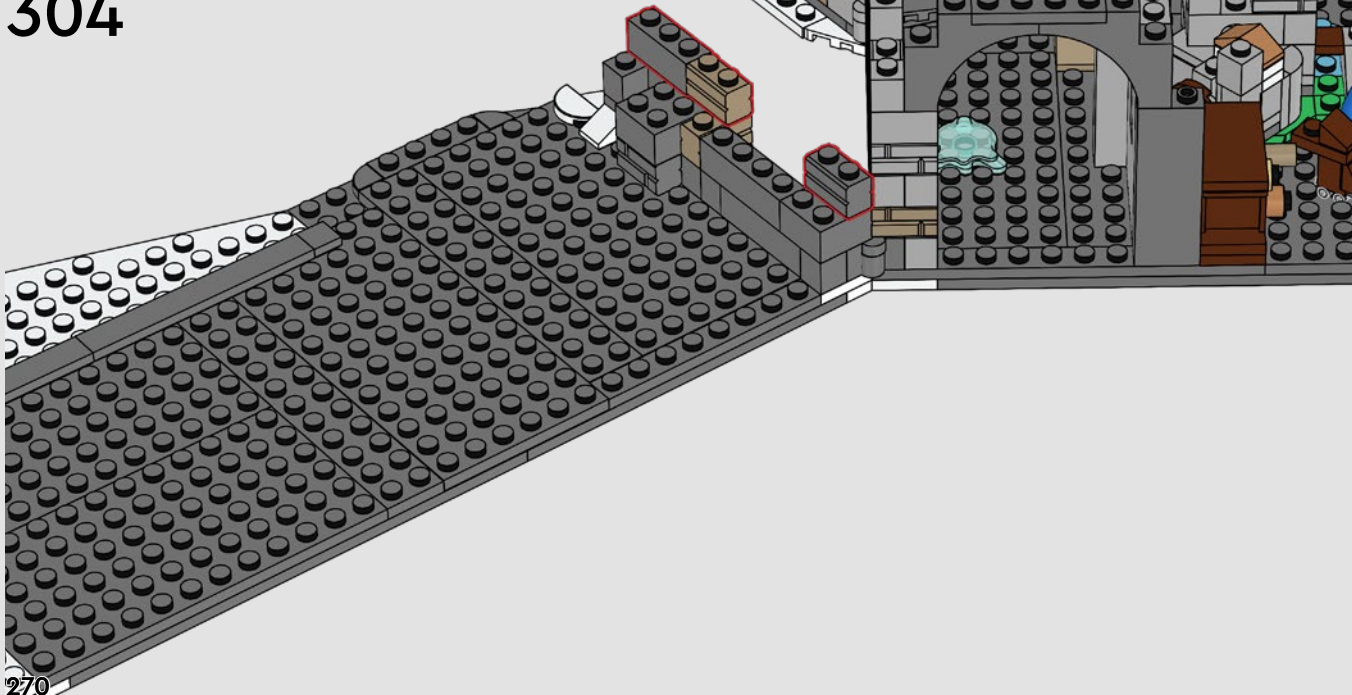

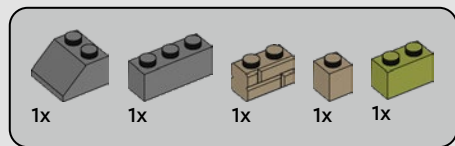

305



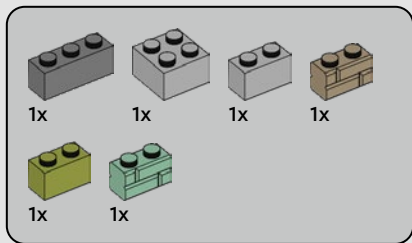

306

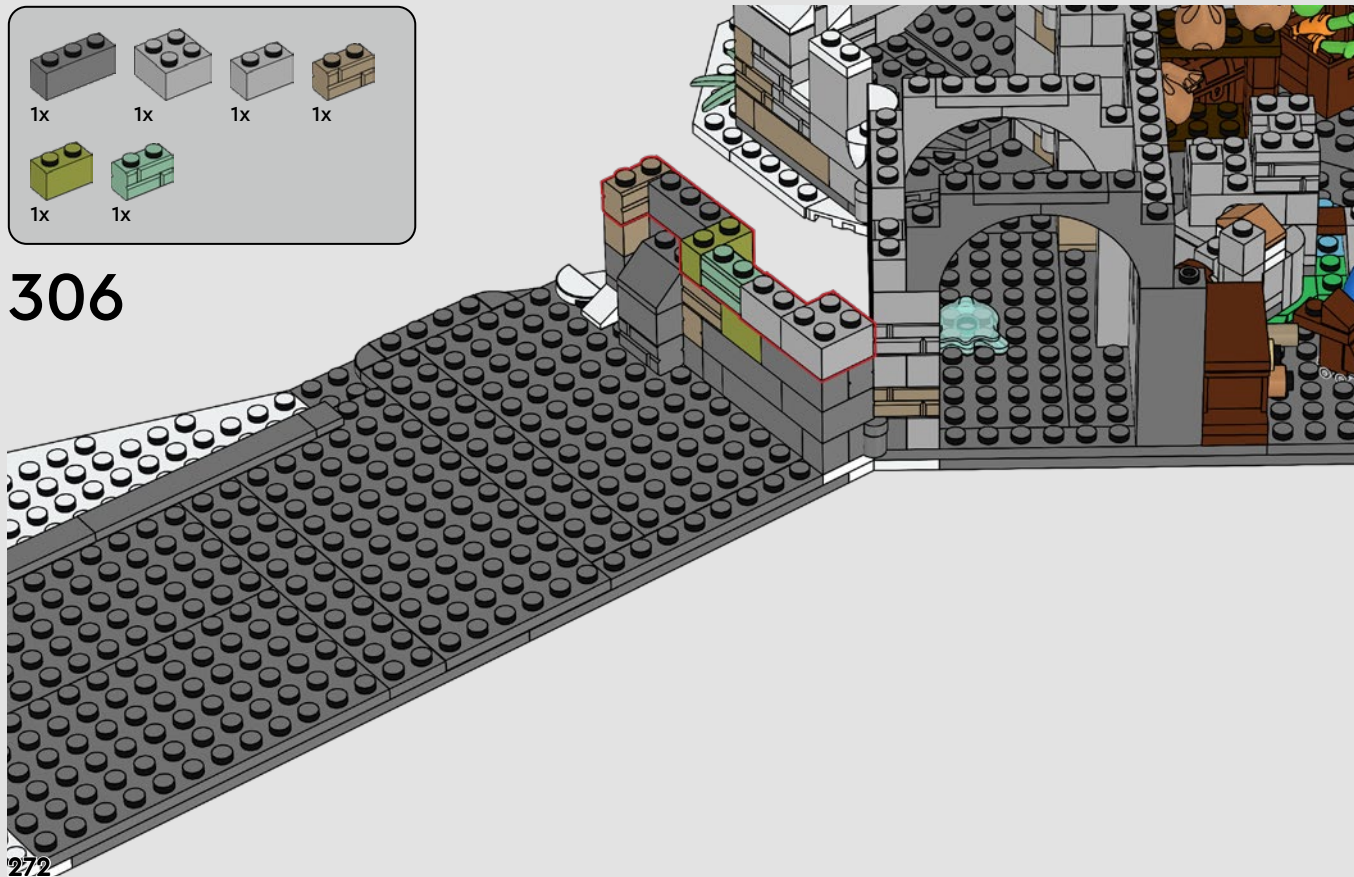

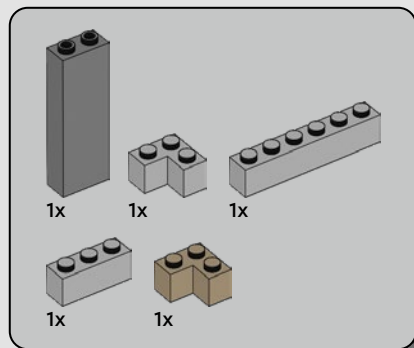

307

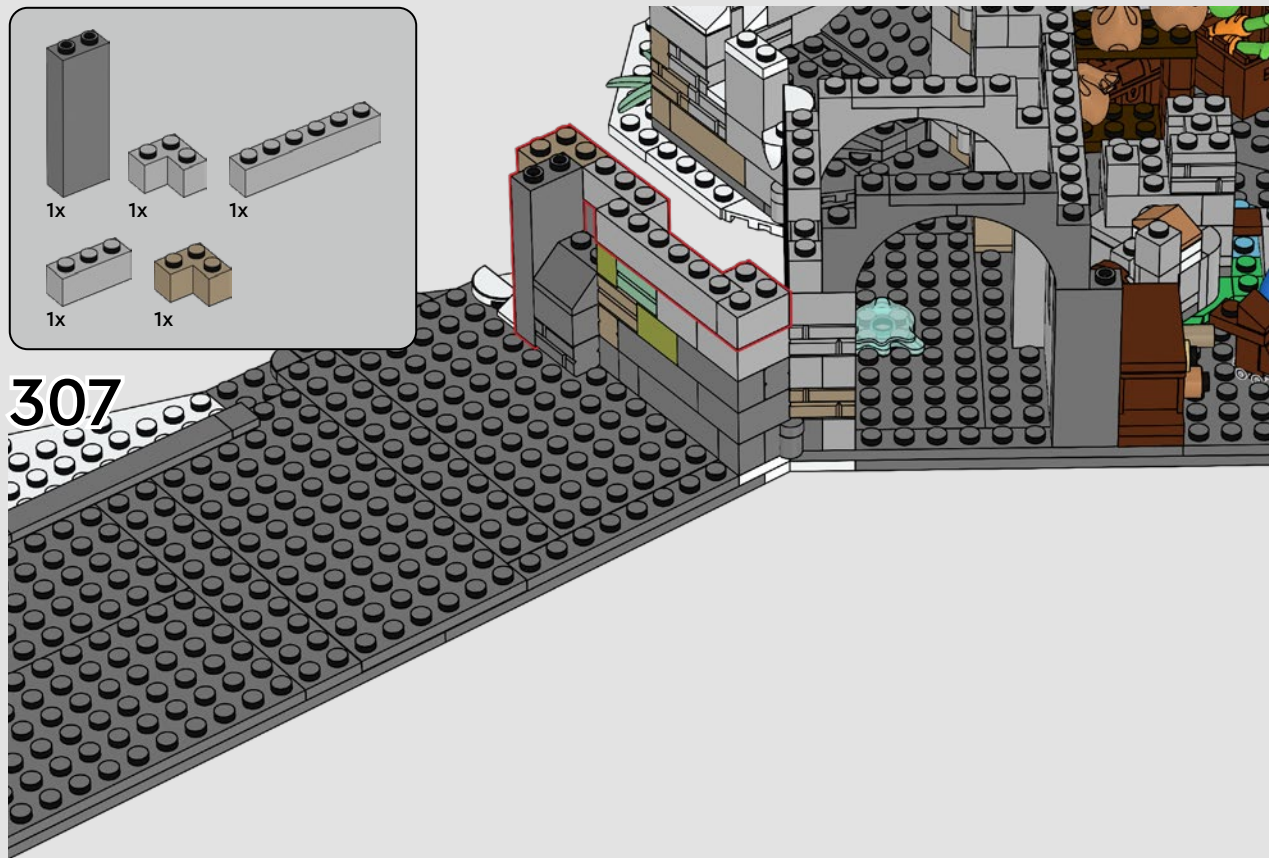

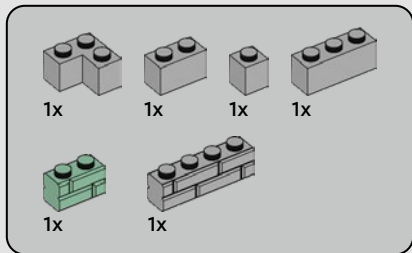

308

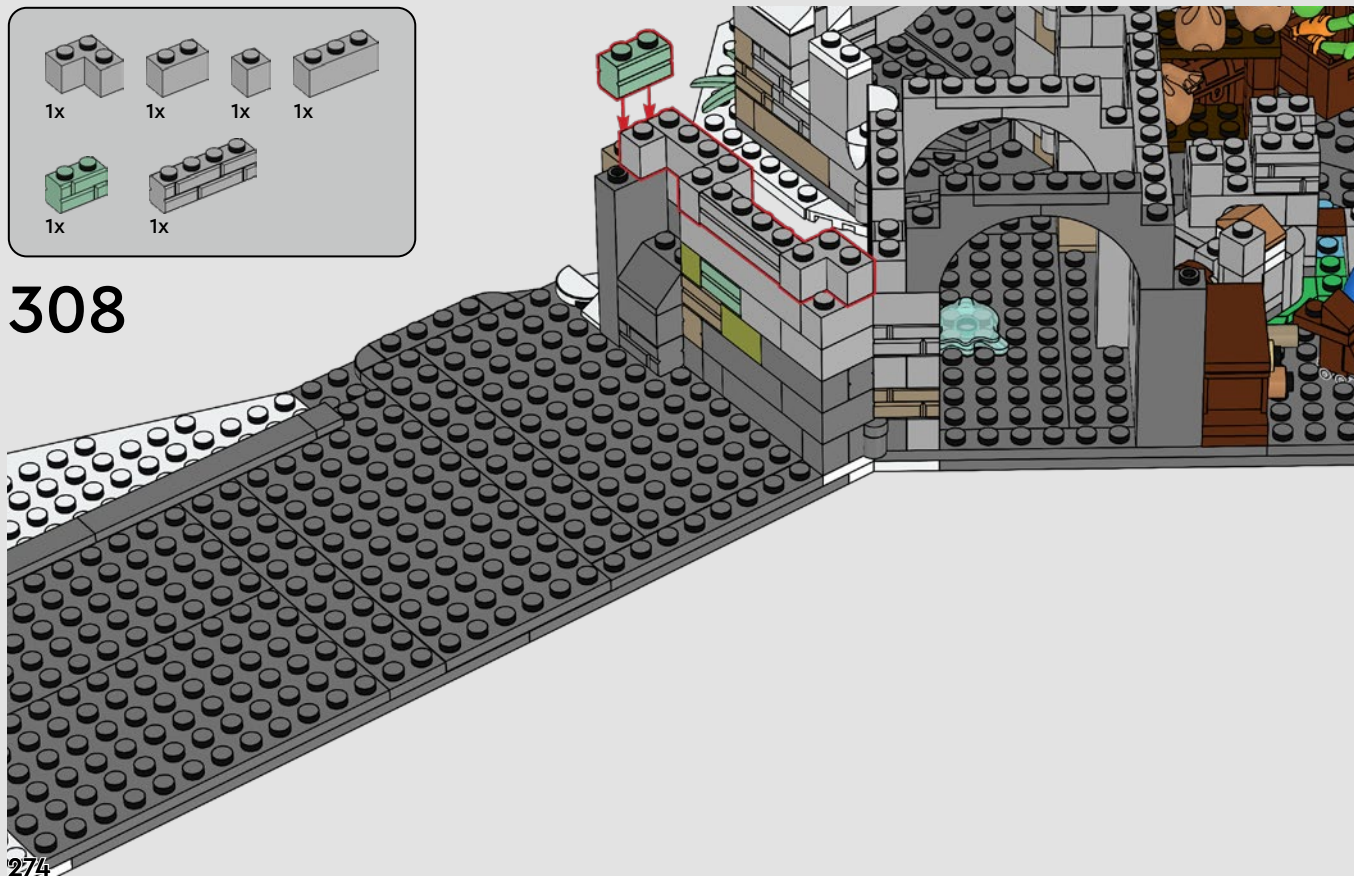

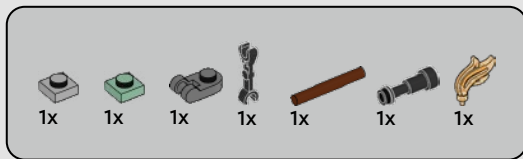

309

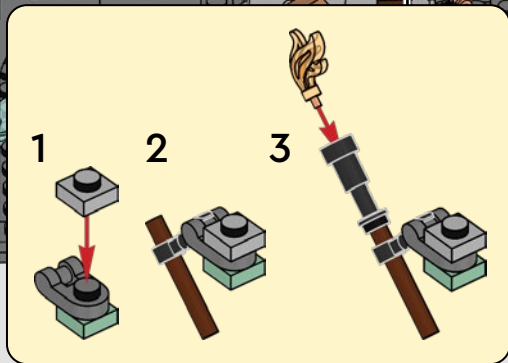
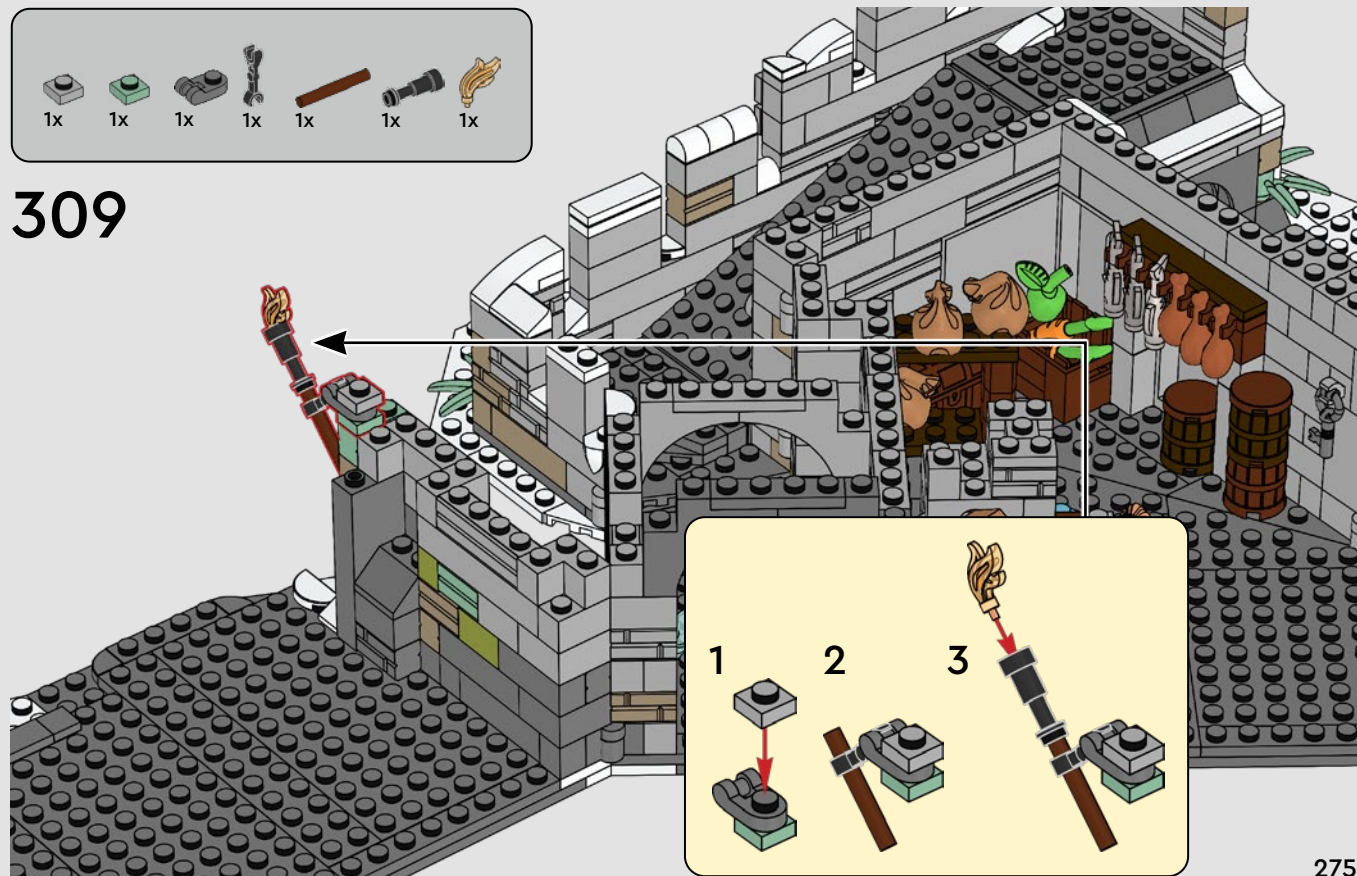

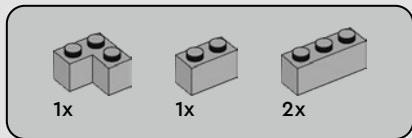

310

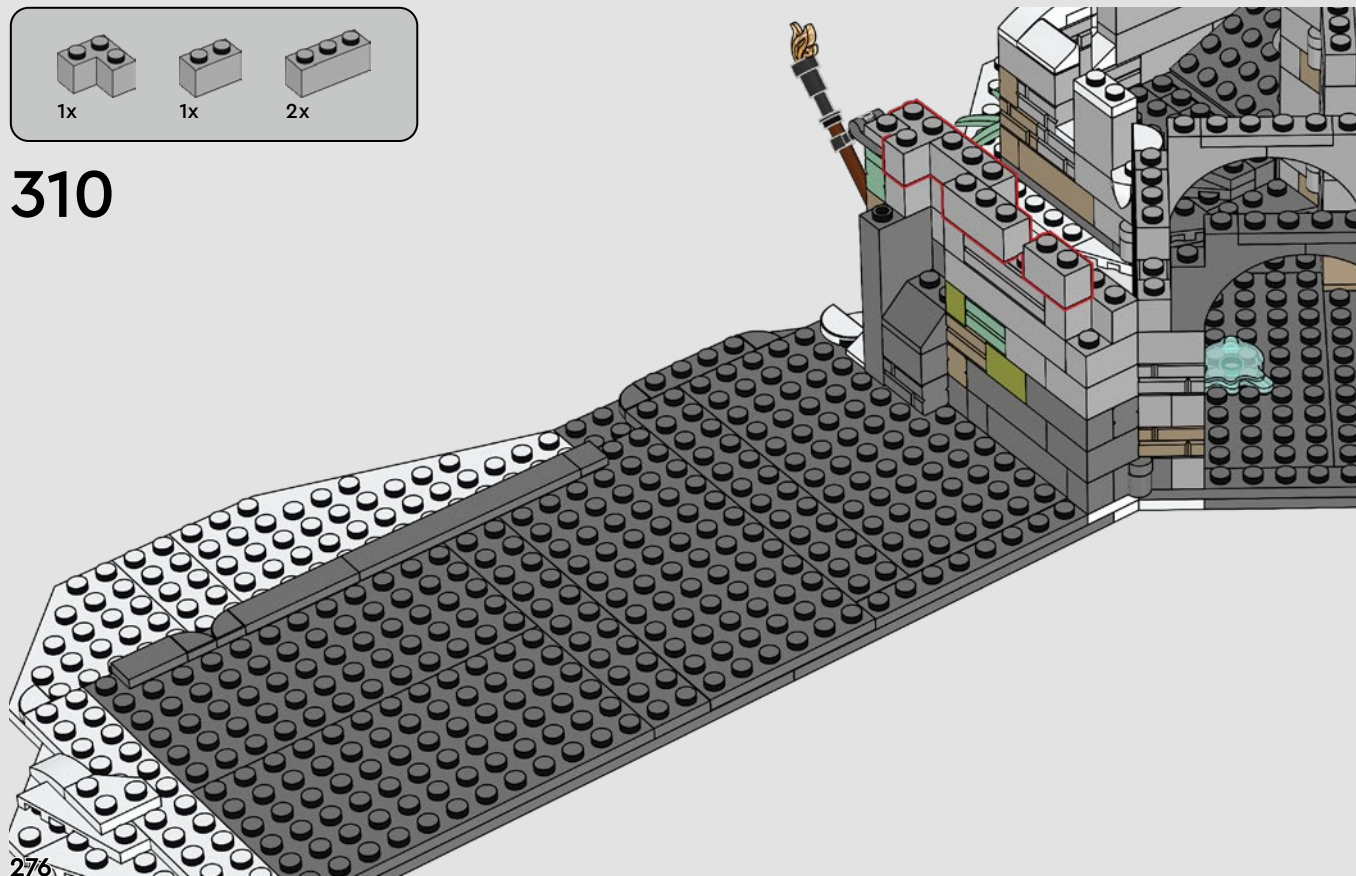

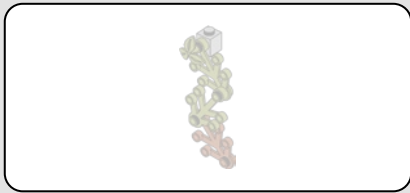

311



312

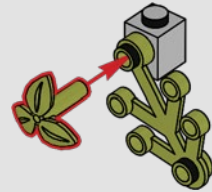

313



314

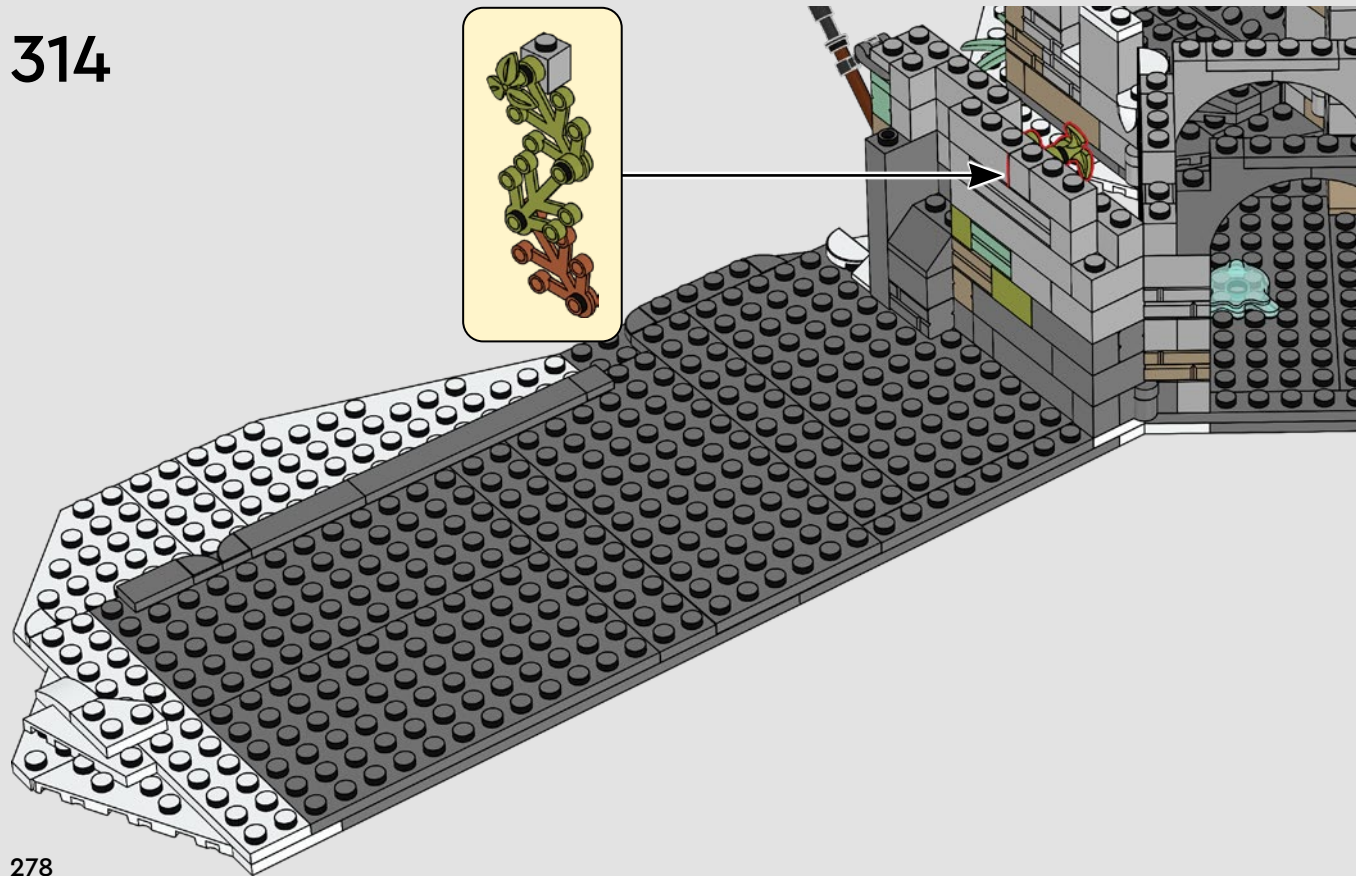



1x



1x

315

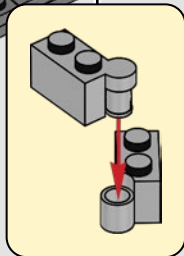
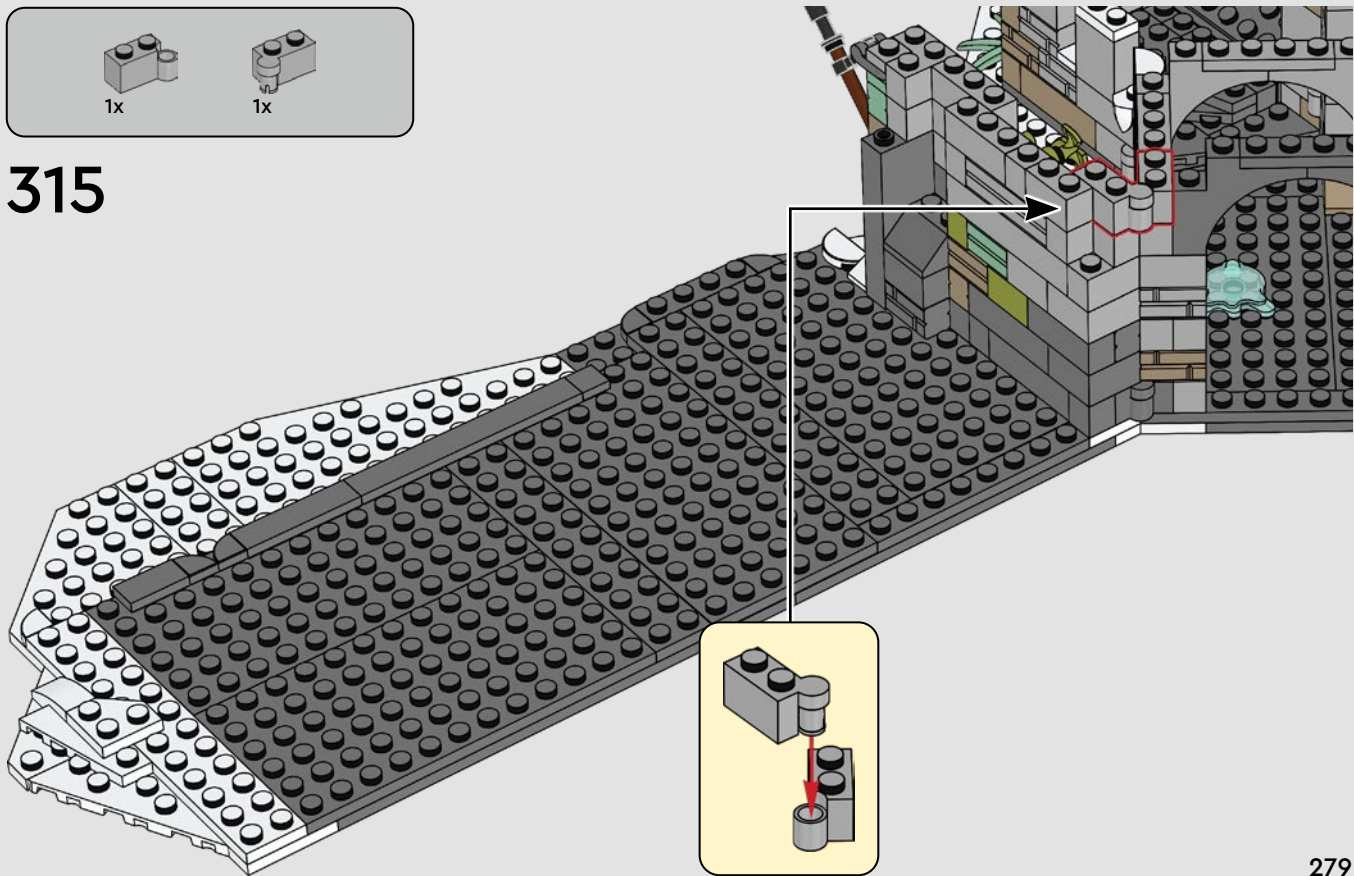

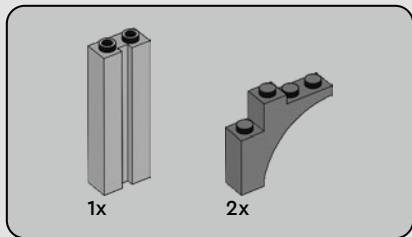

316

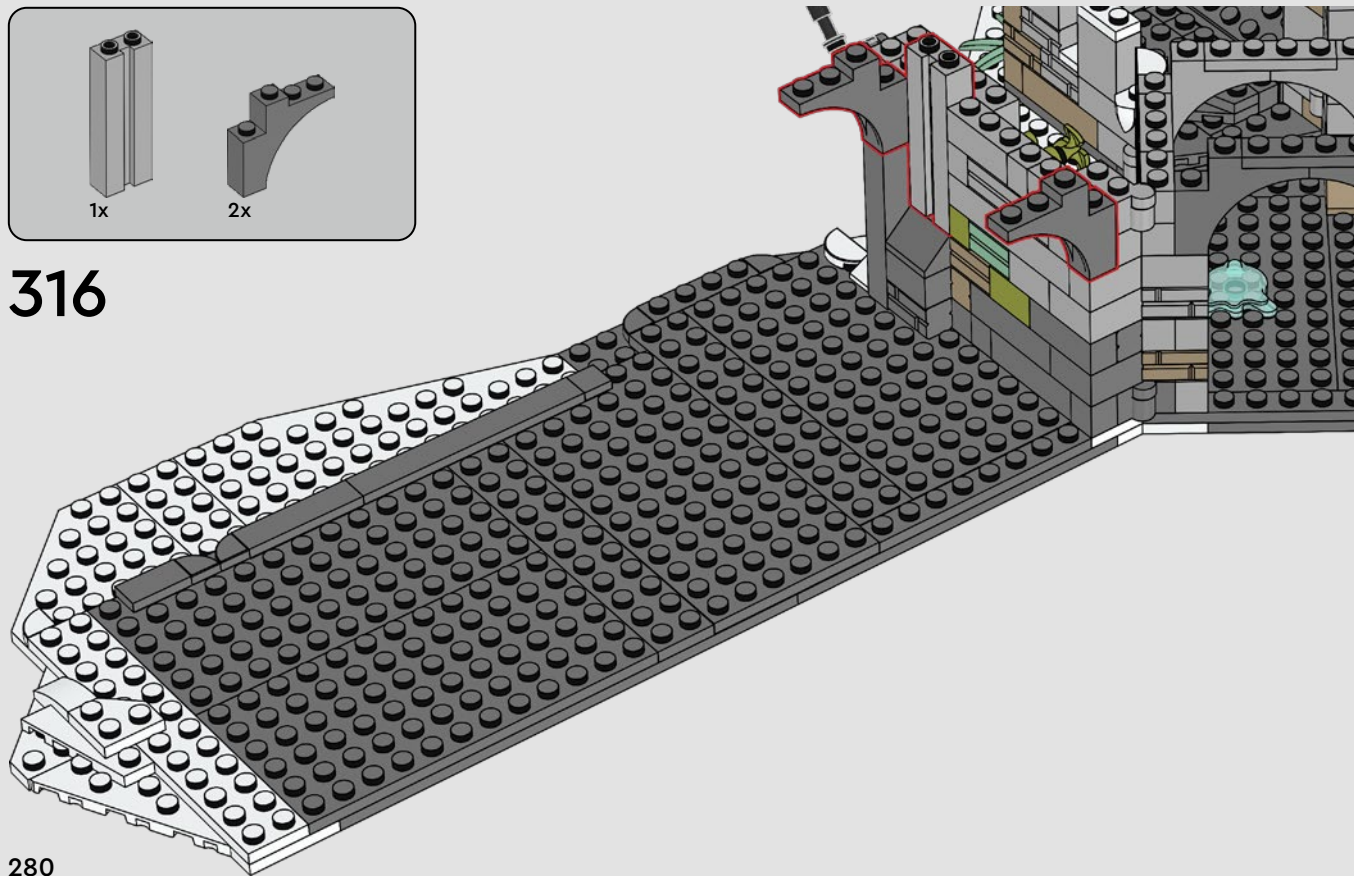

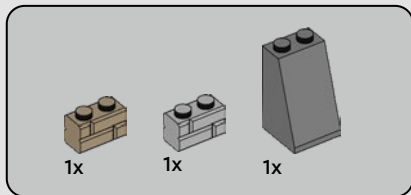

317

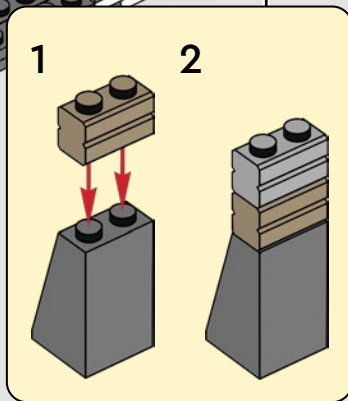
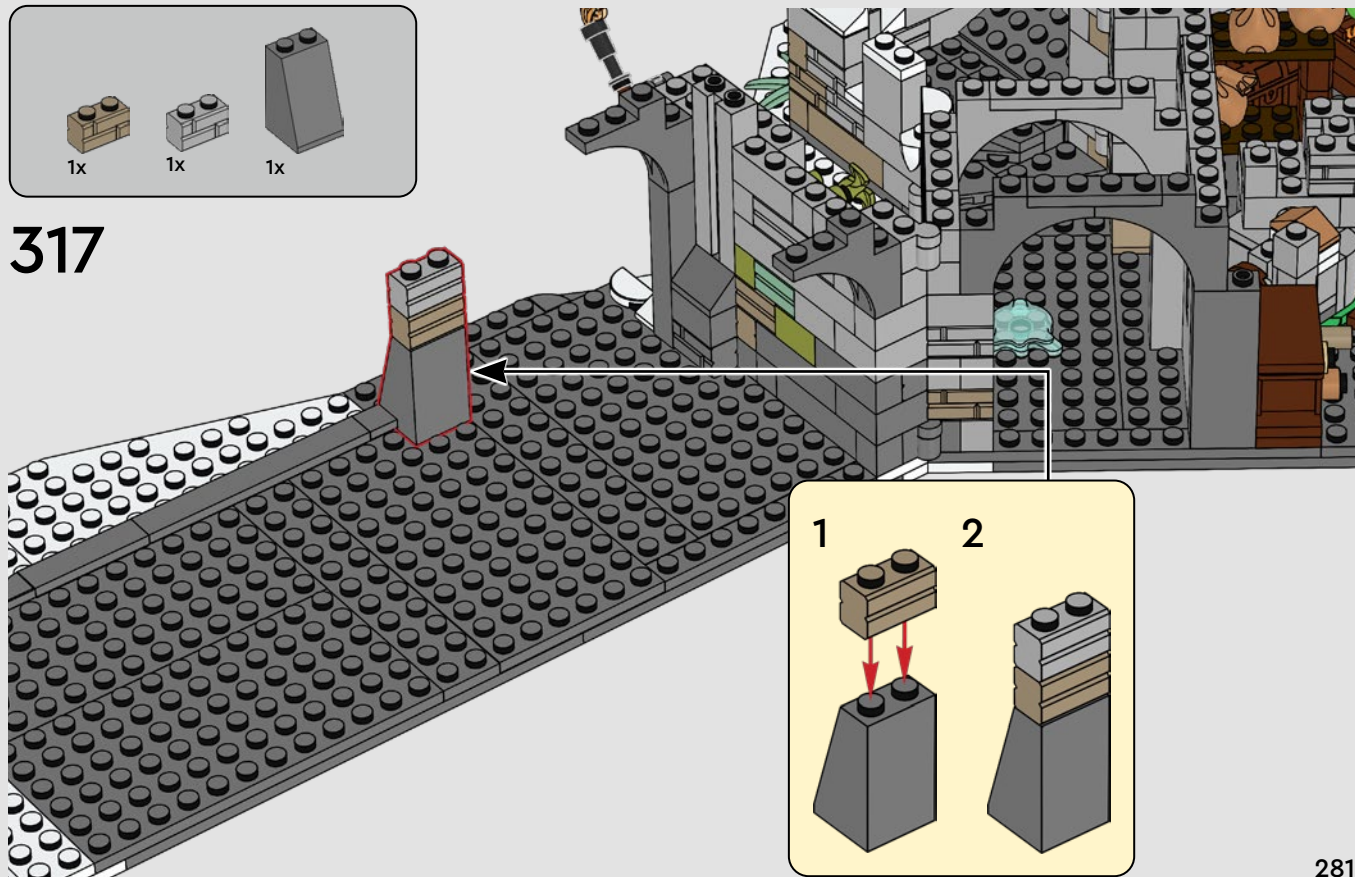

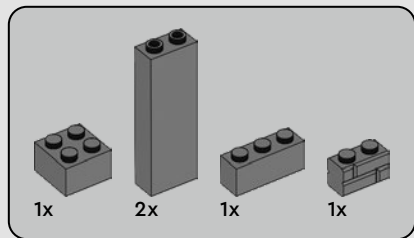

318

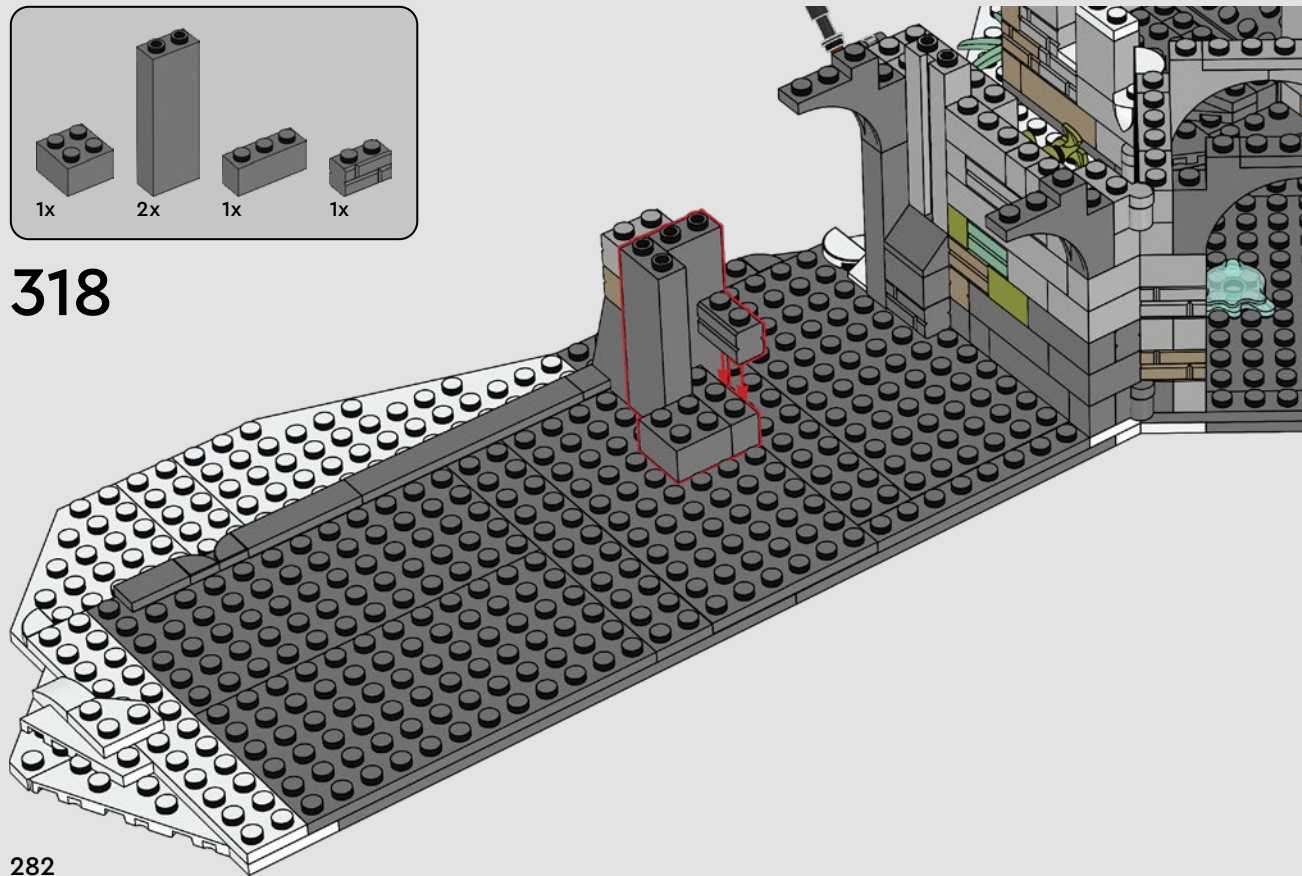

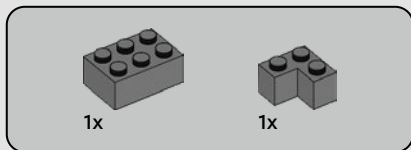

319

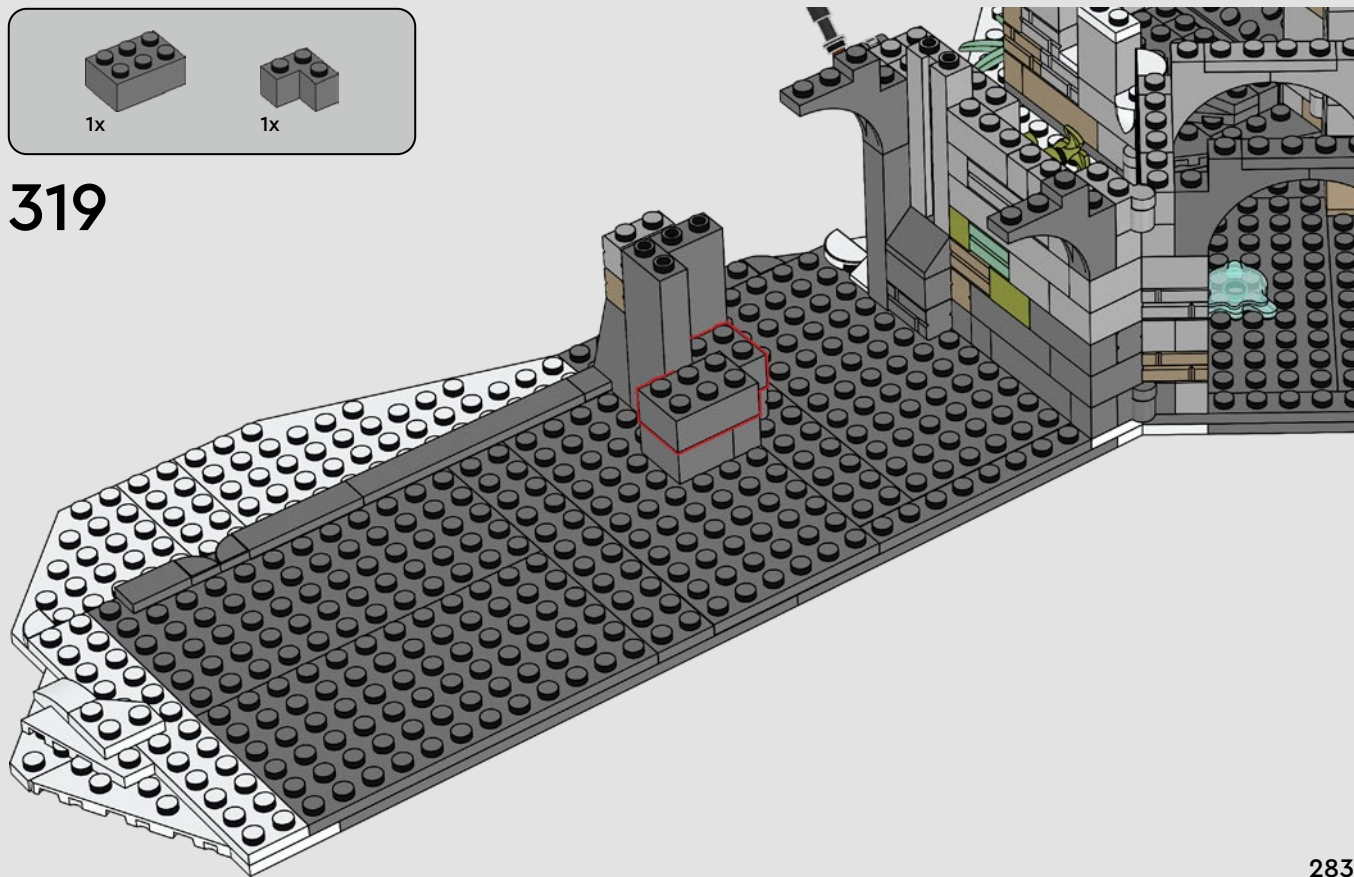

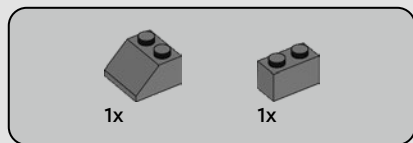

321

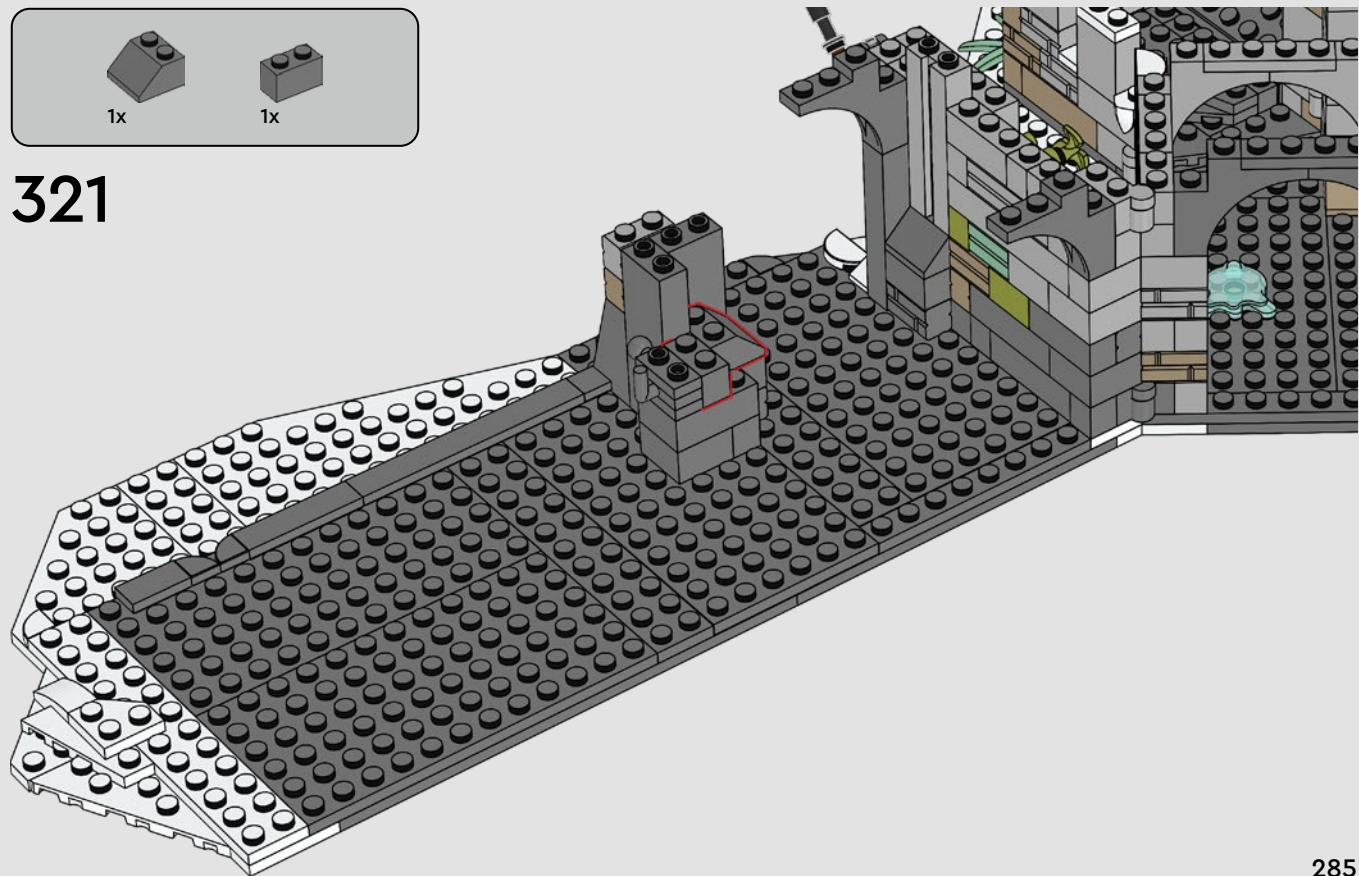

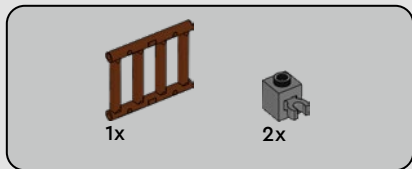

322

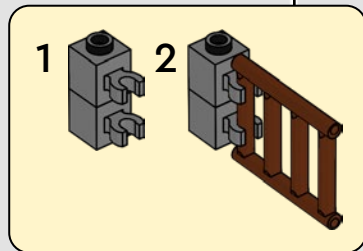
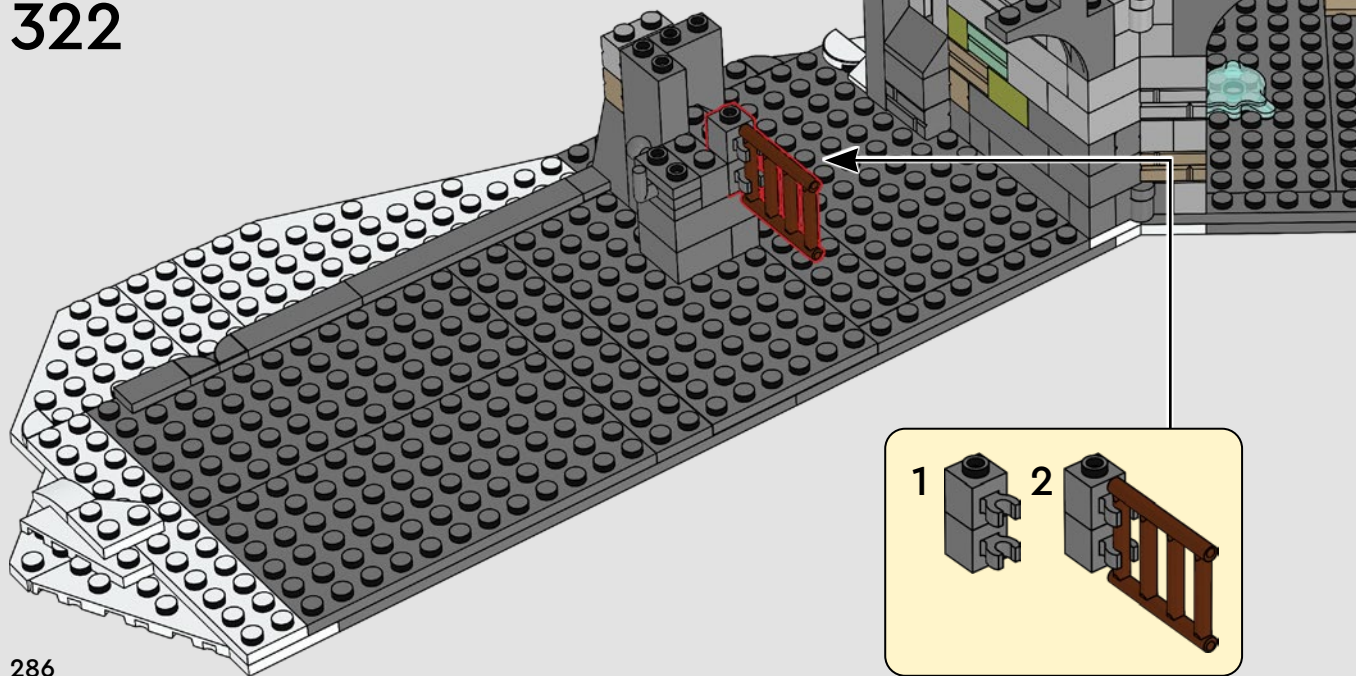



1x



2x

323

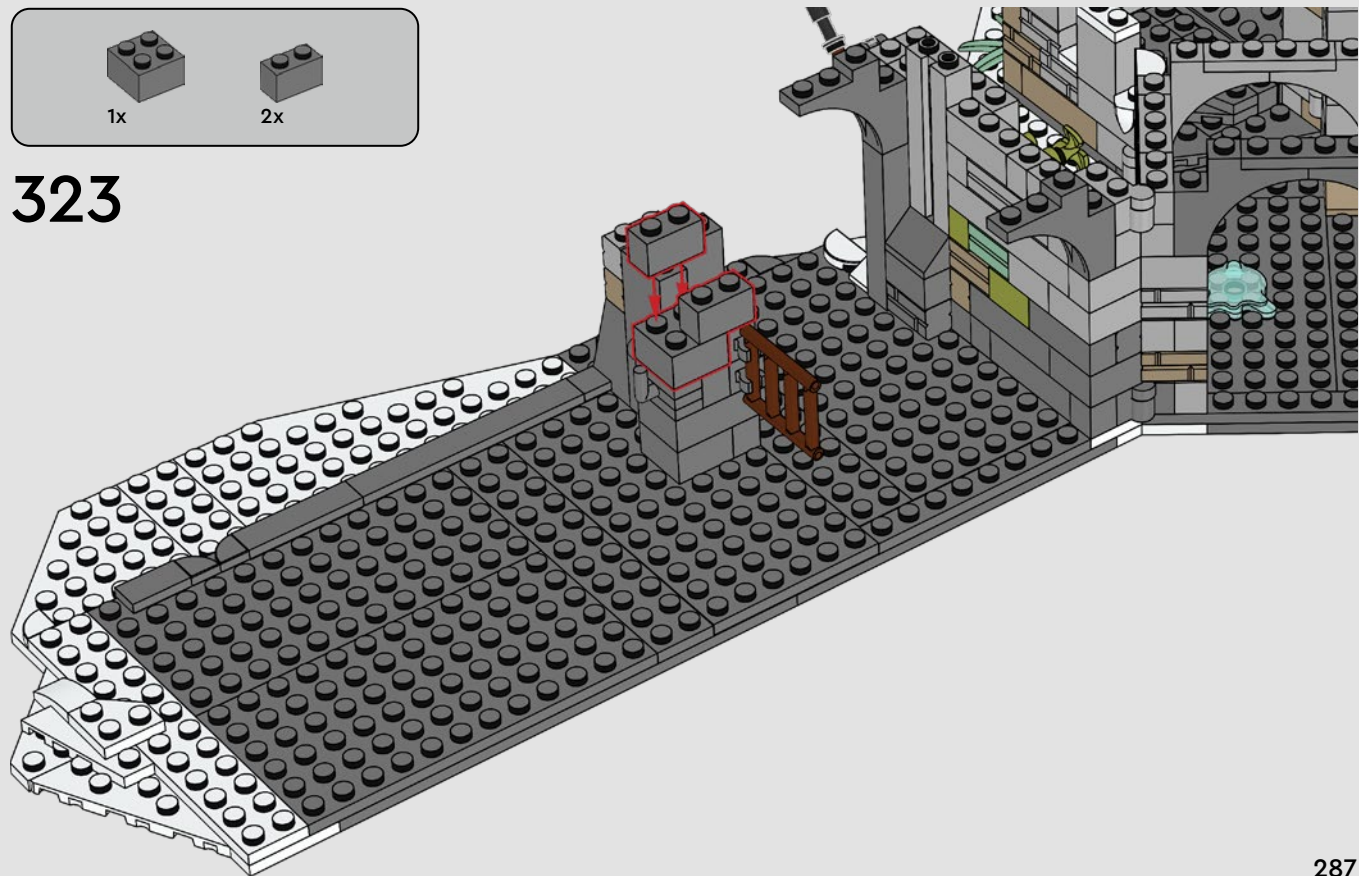

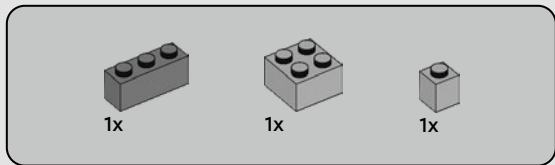

324

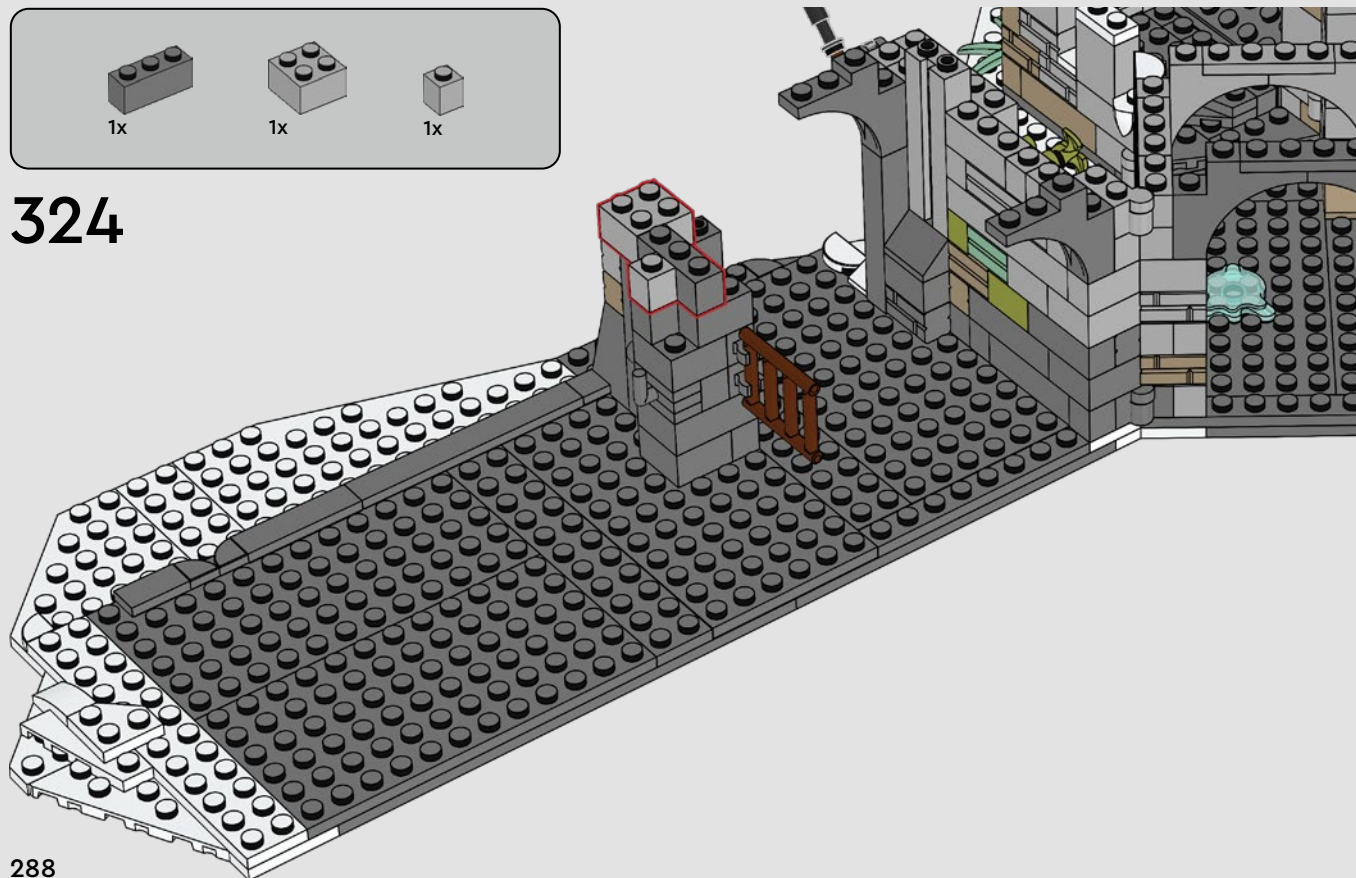

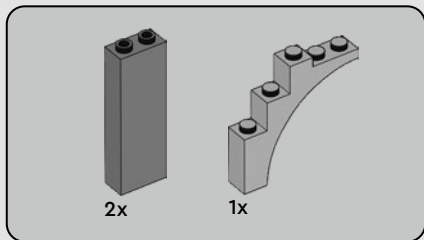

325

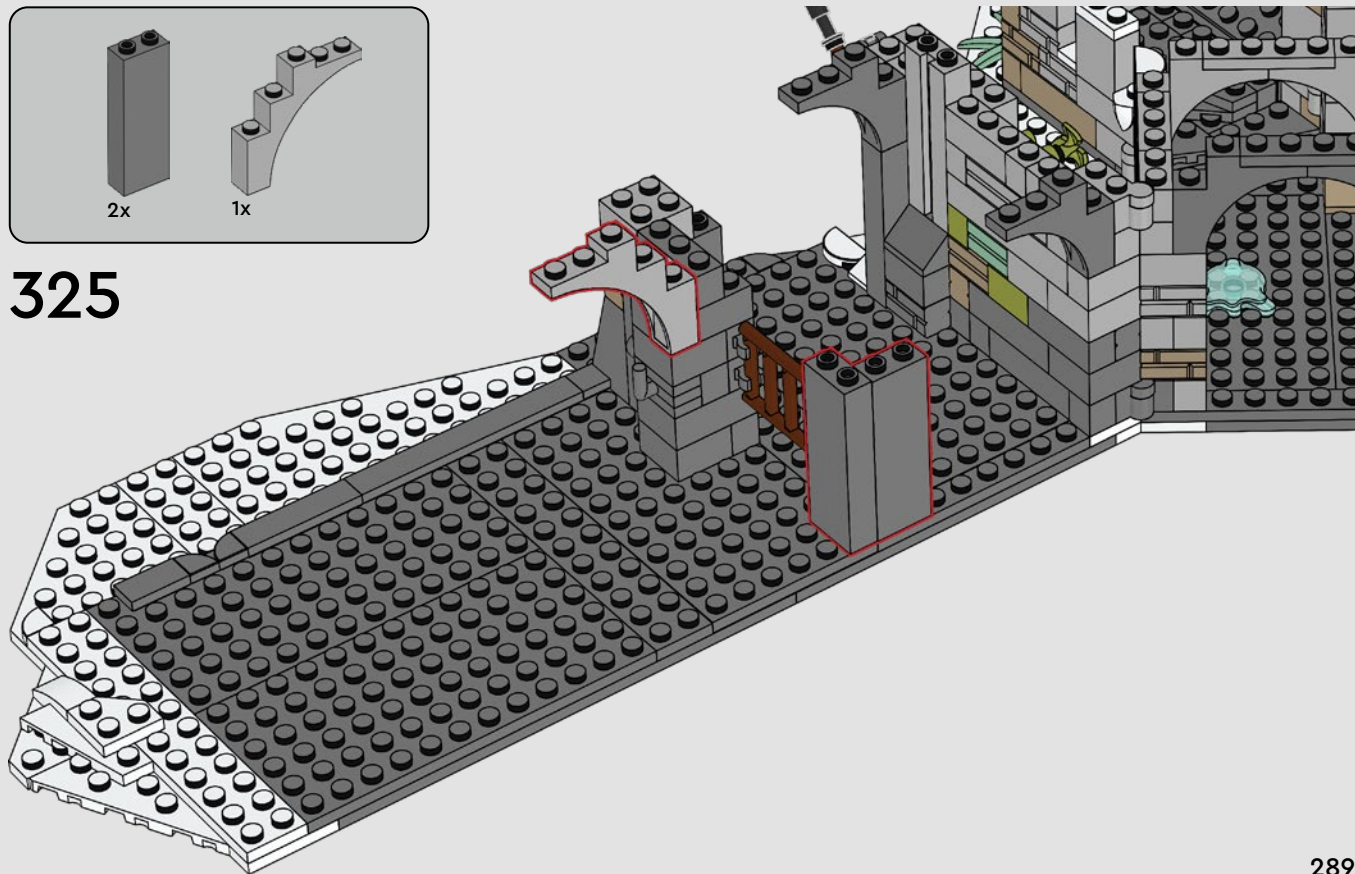



326

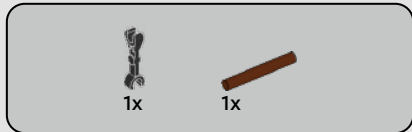

327



328

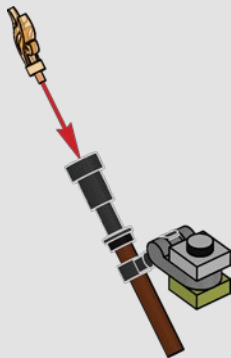

329

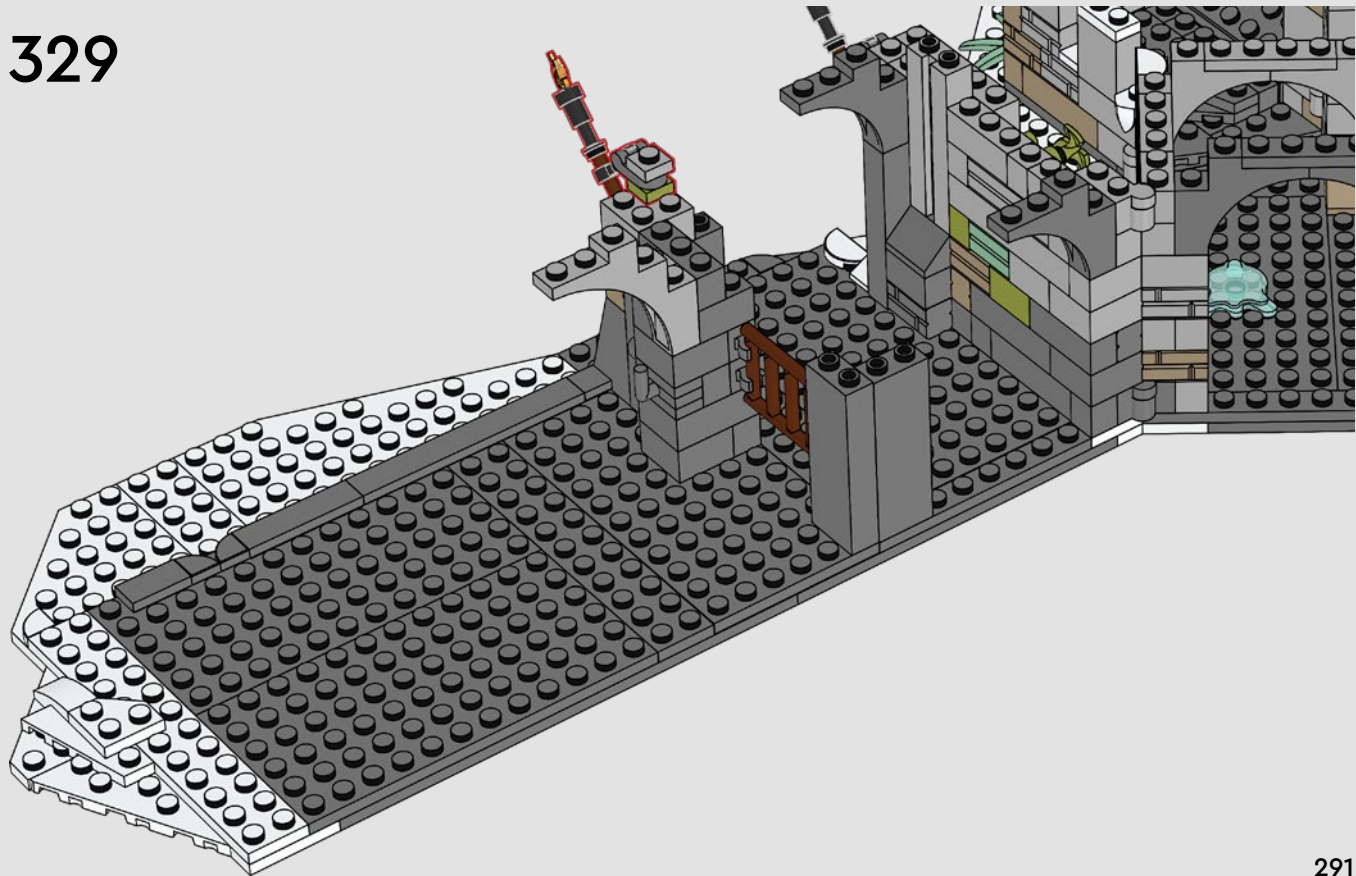

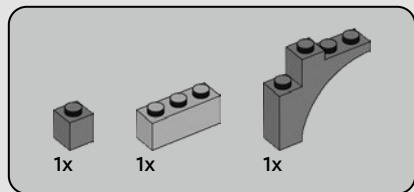

330

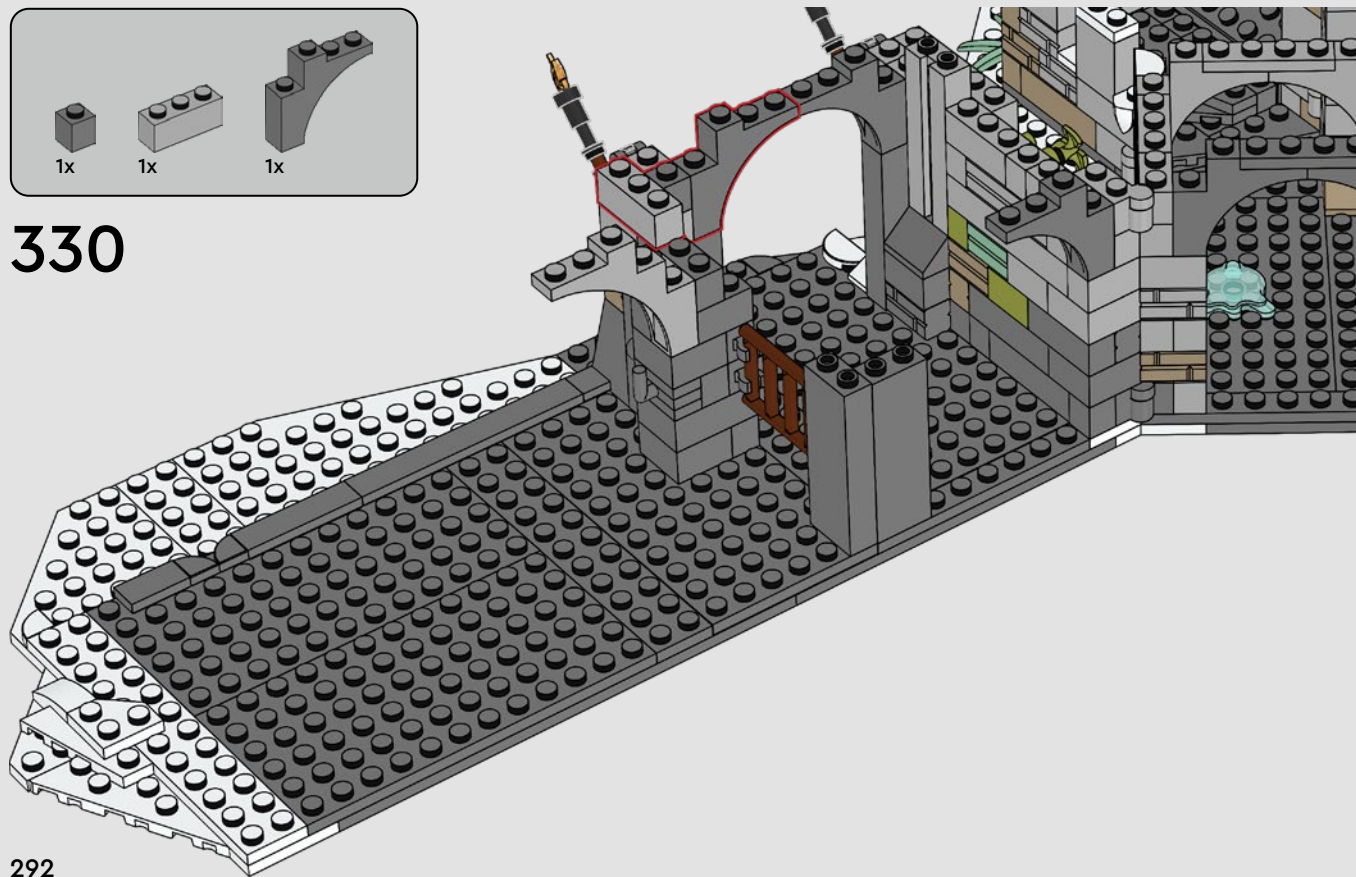

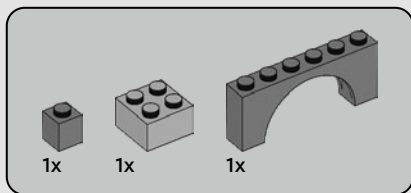

331

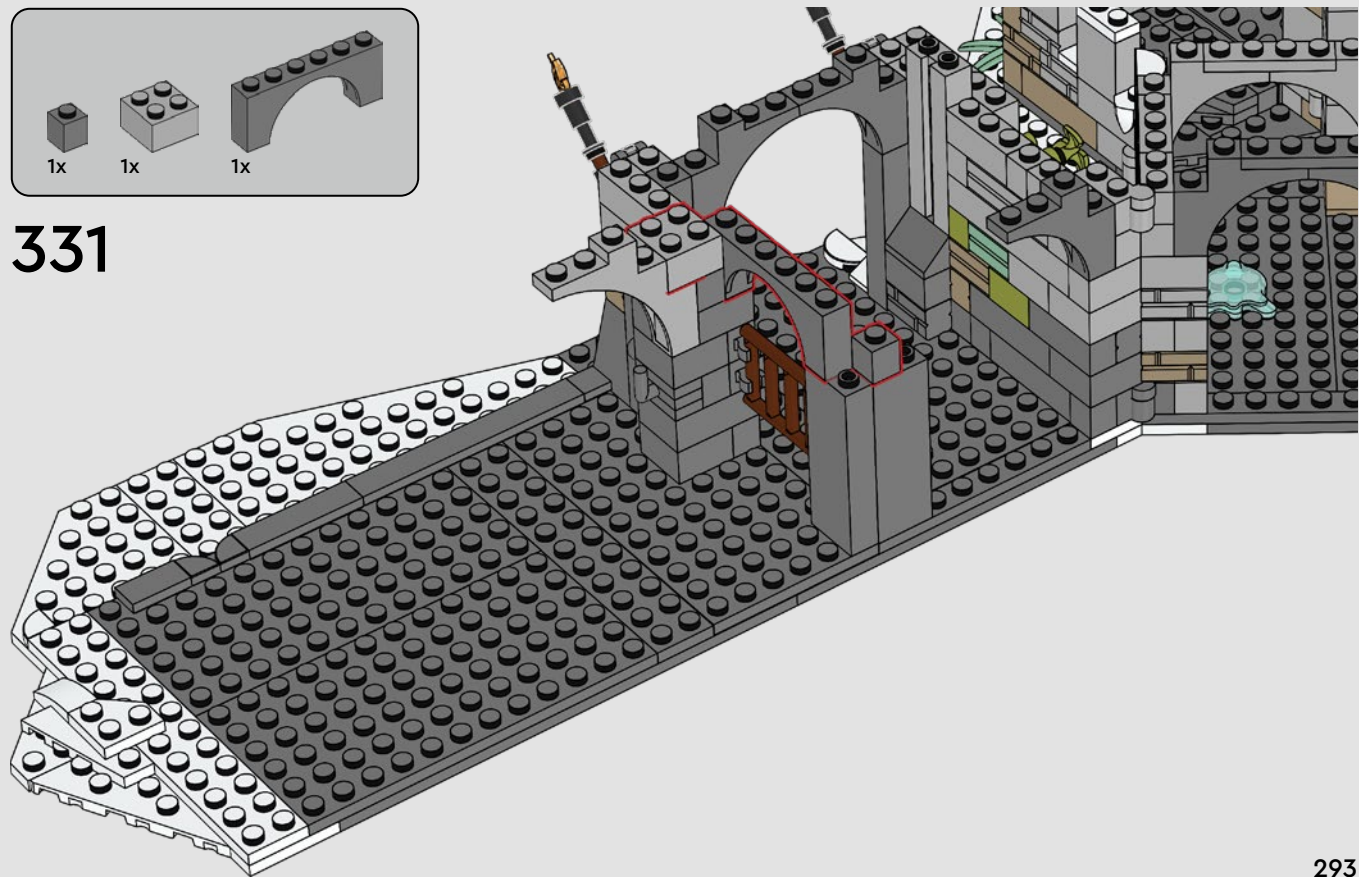

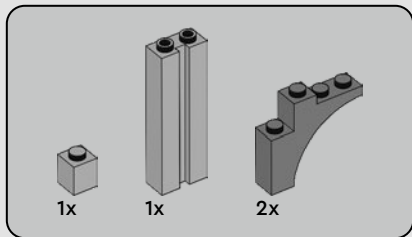

332

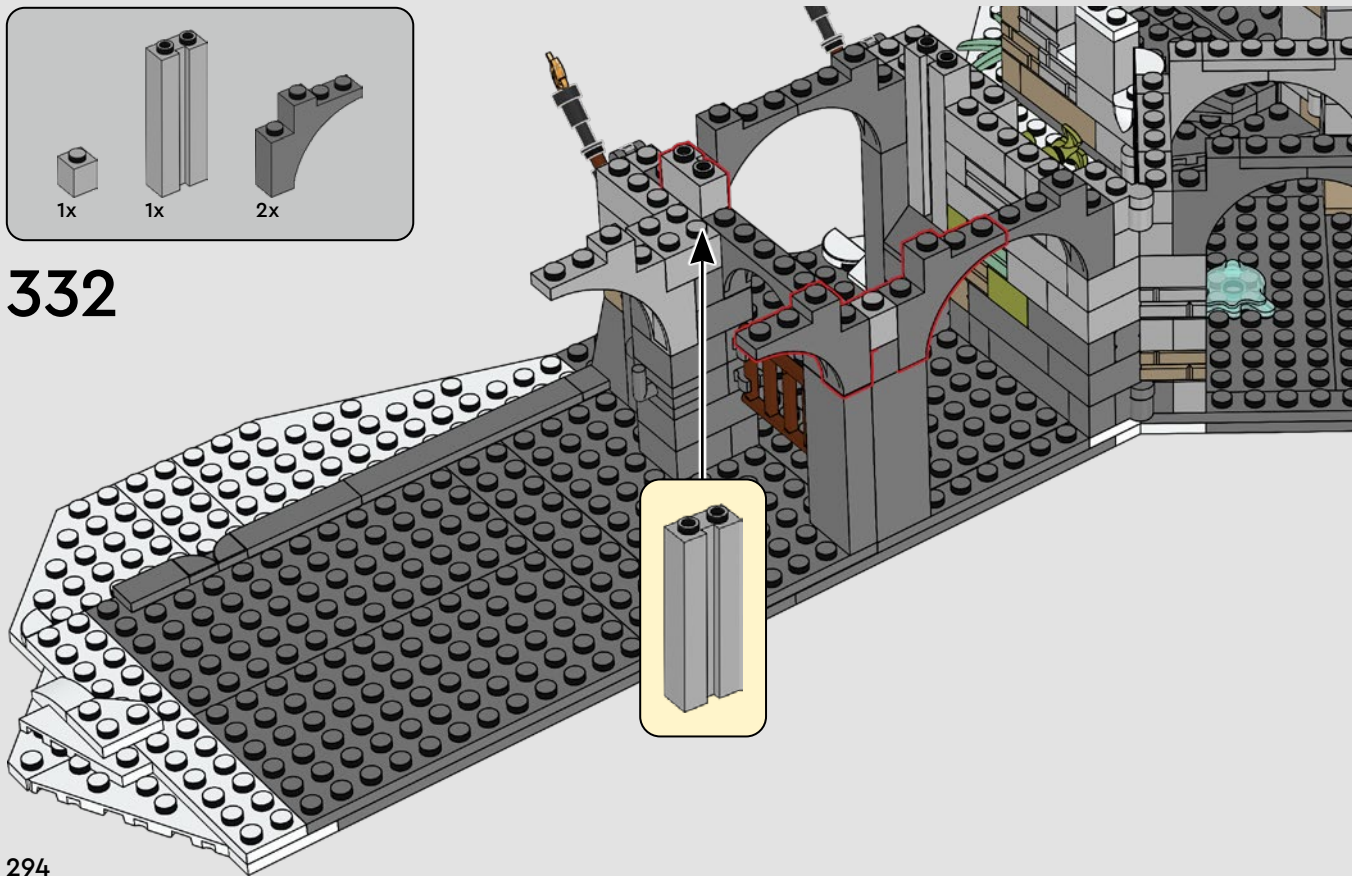

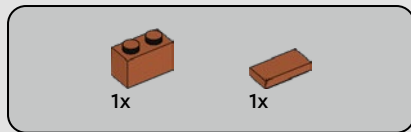

333

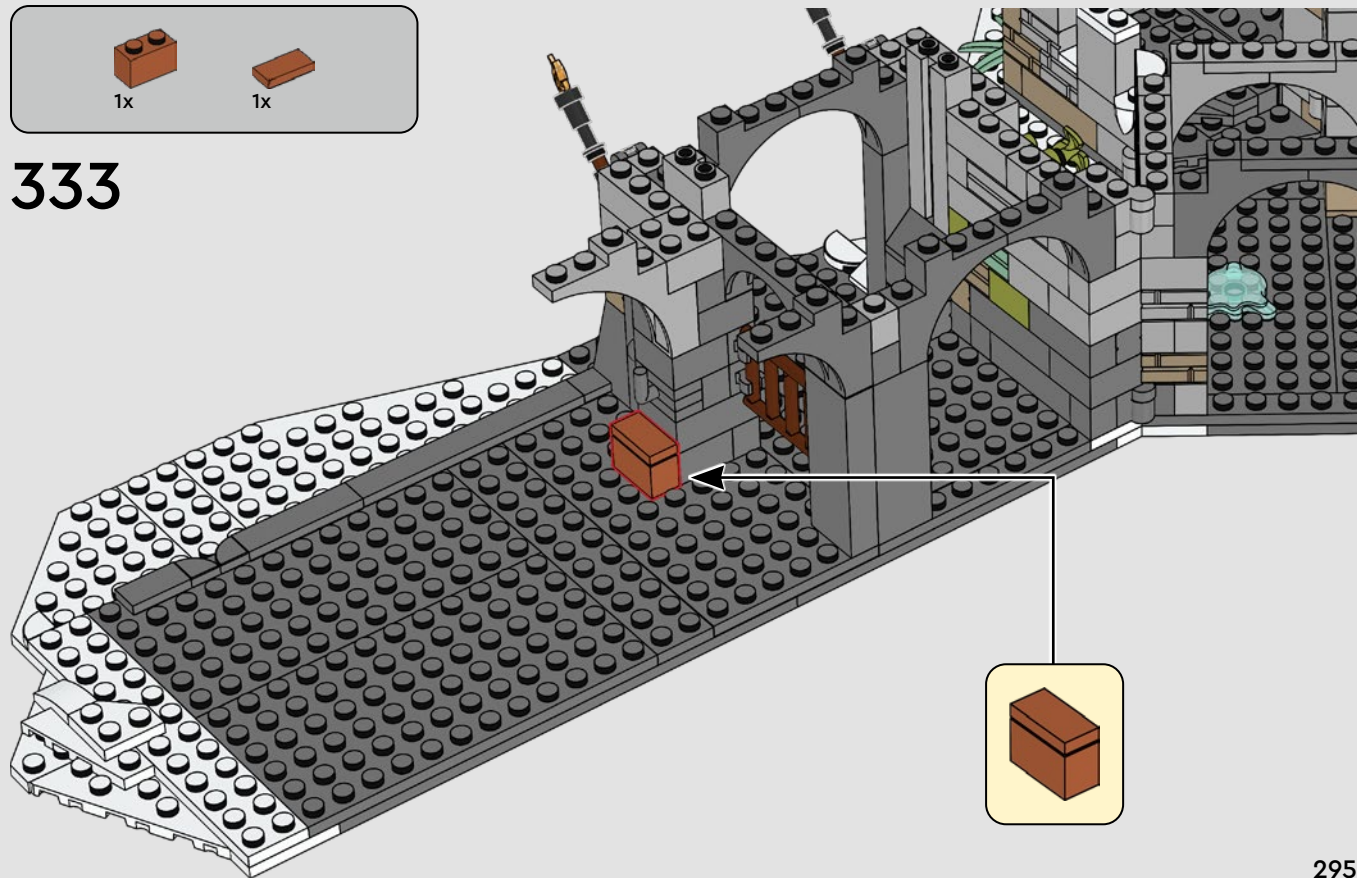



2x

334

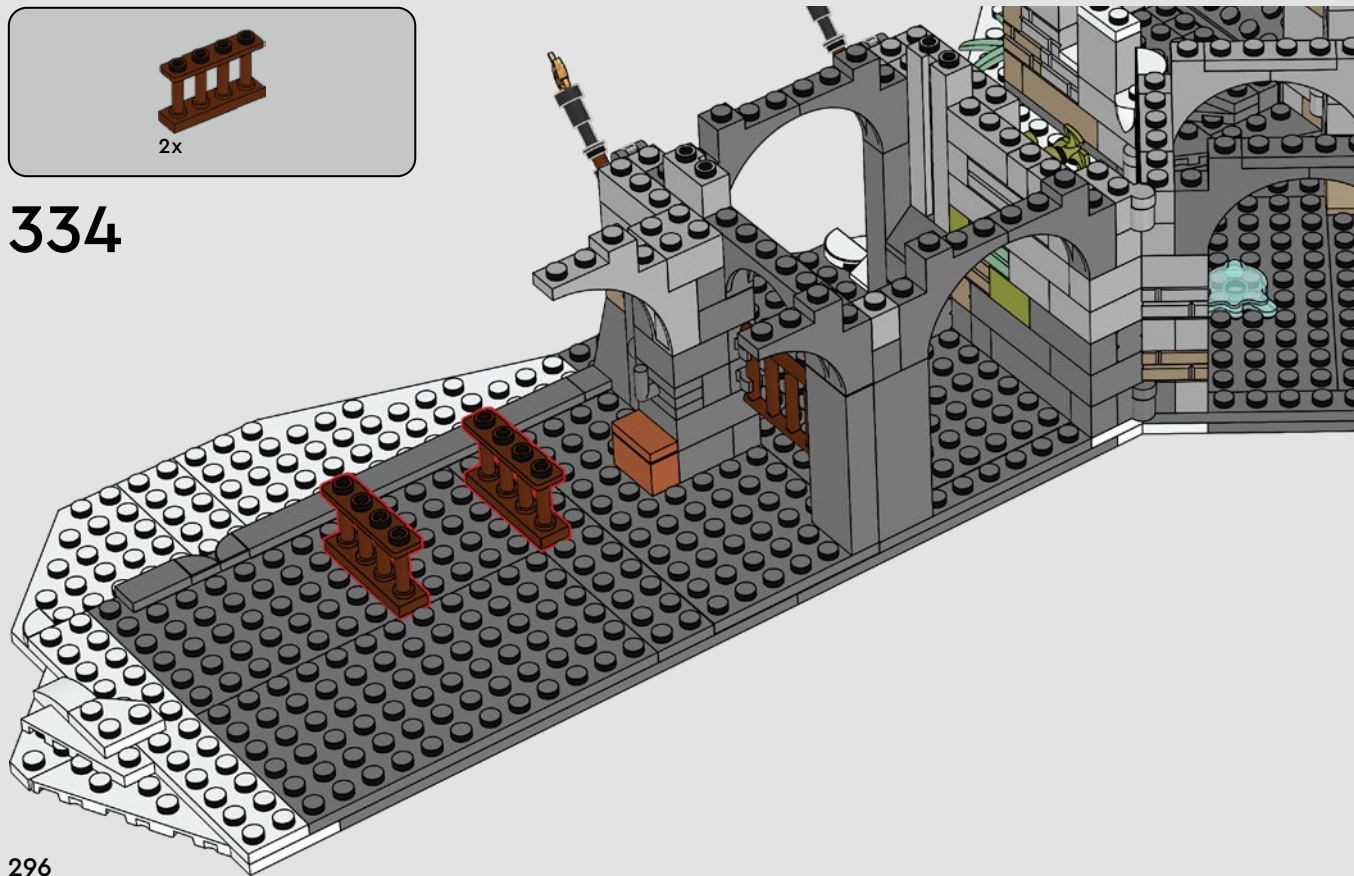

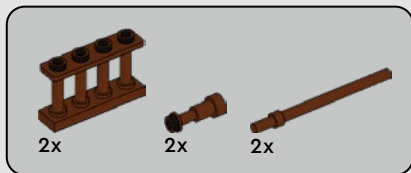

335

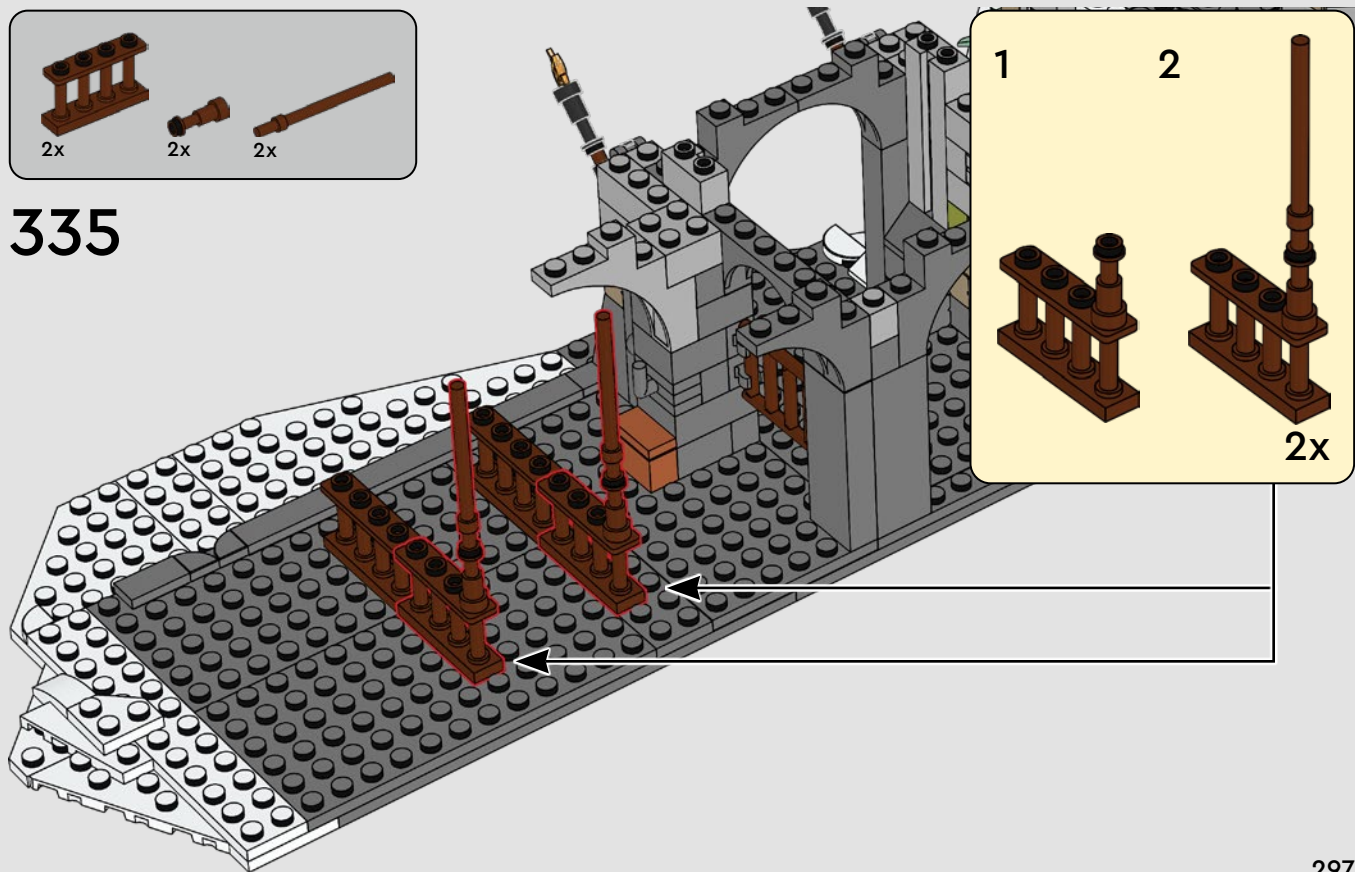

336

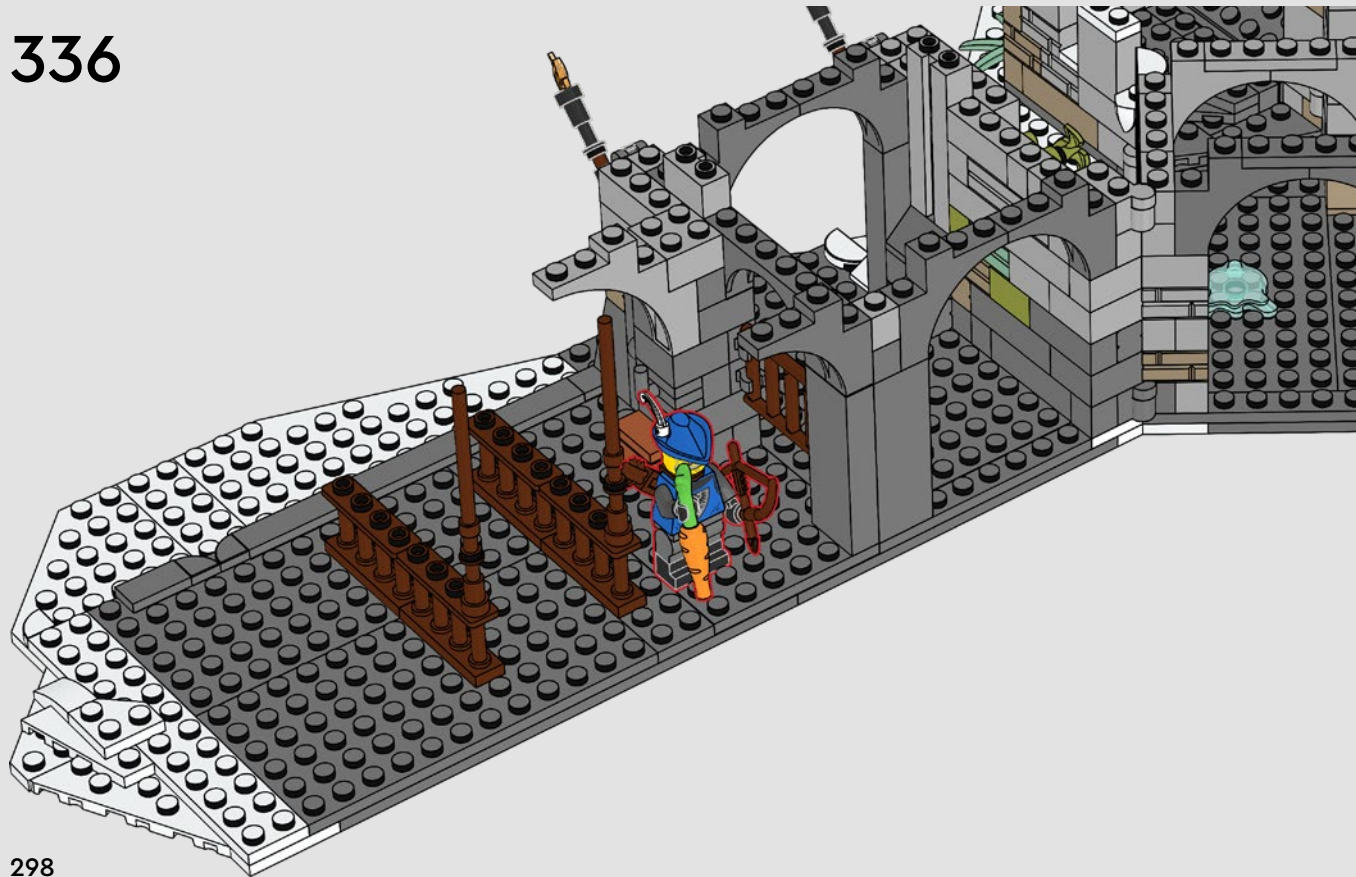

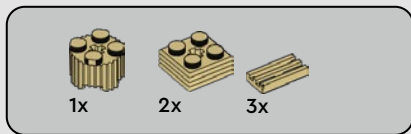

337

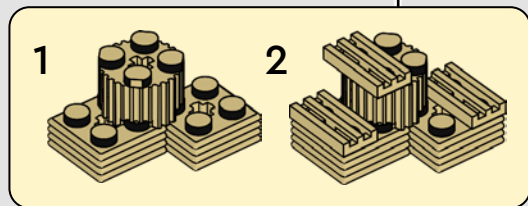
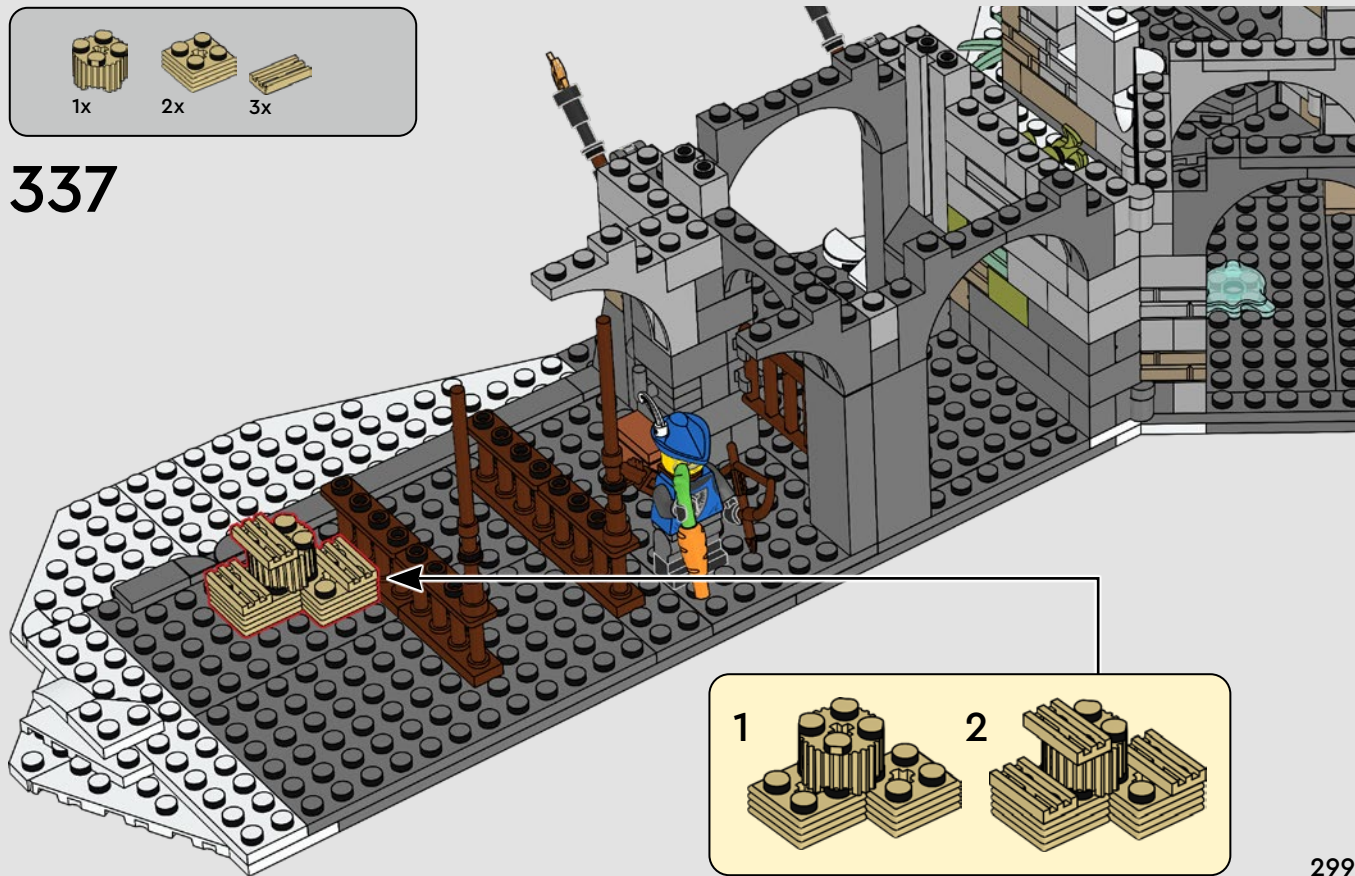



1x



1x

339

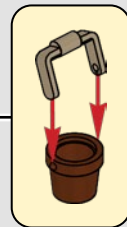
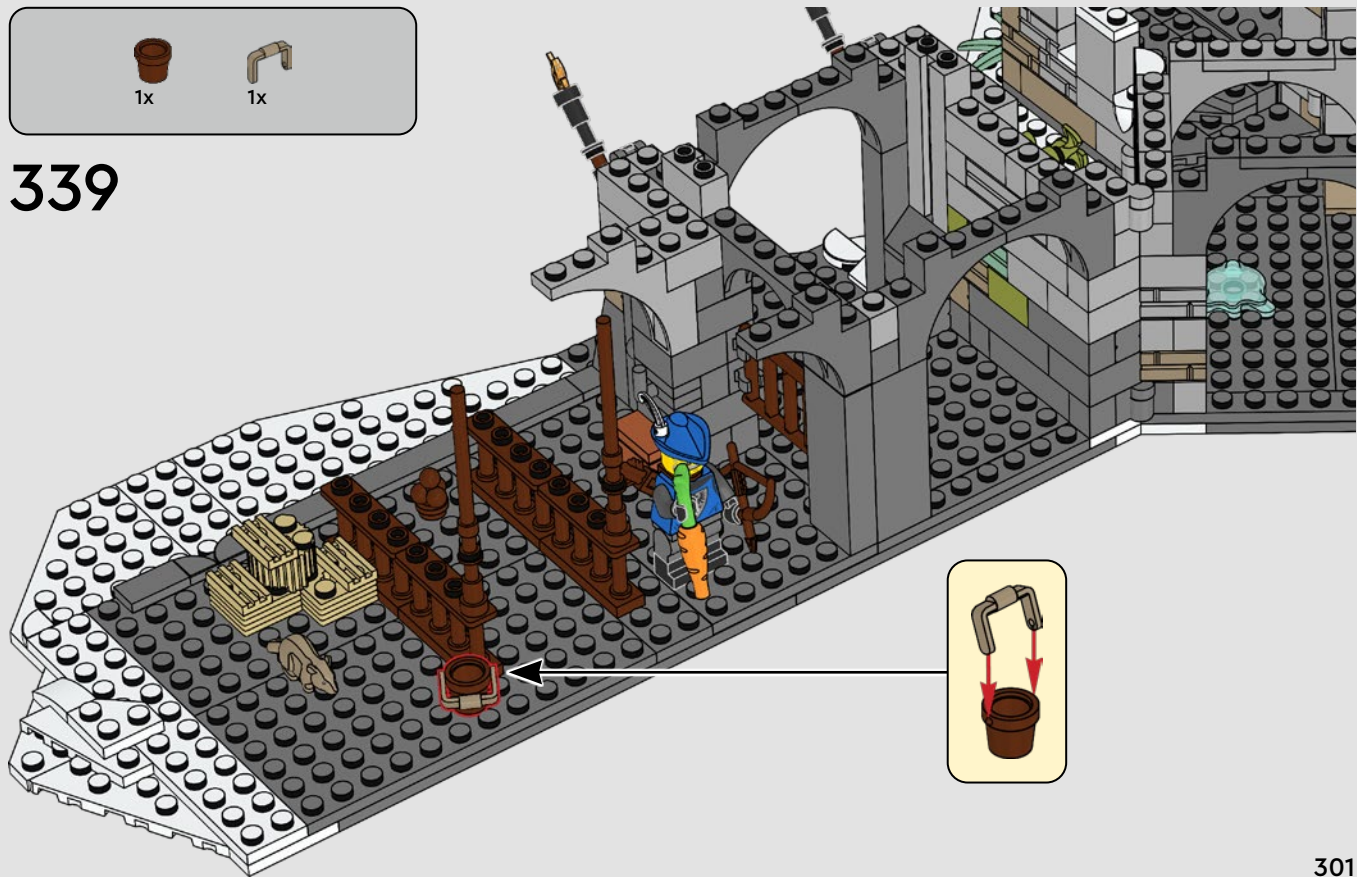

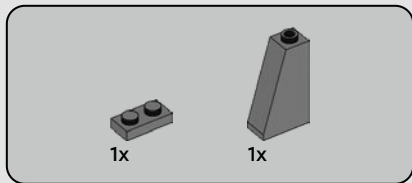

340





1x



1x



1x

342





1x



1x

343



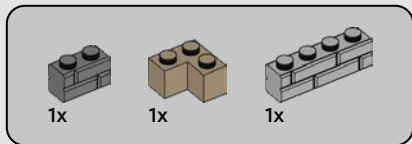

344



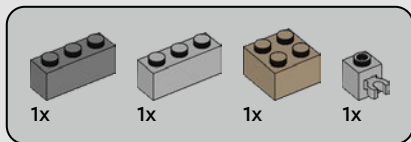

345





1x



2x



1x

346



1



2



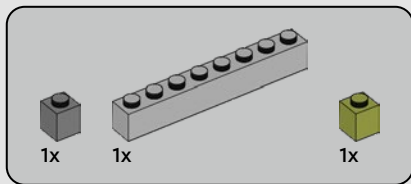

347



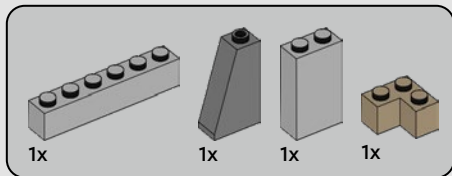

348

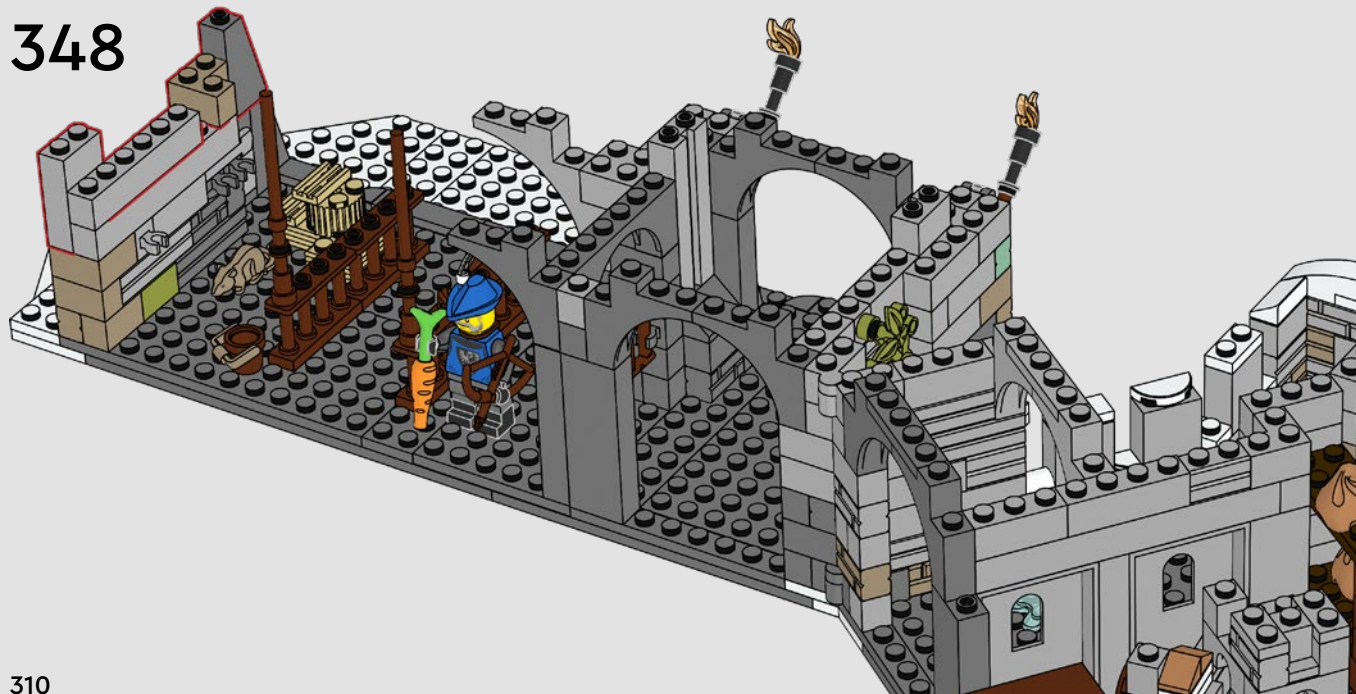

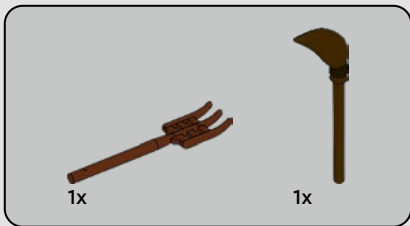

349

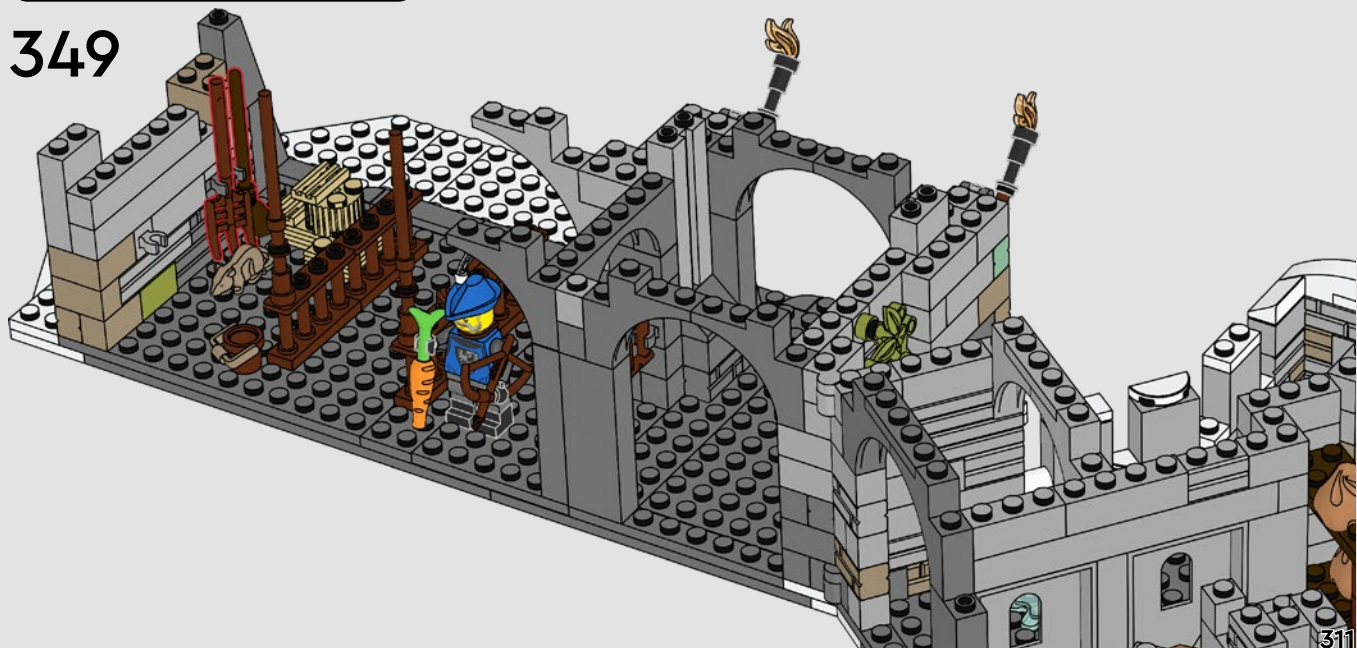



1x



1x

350

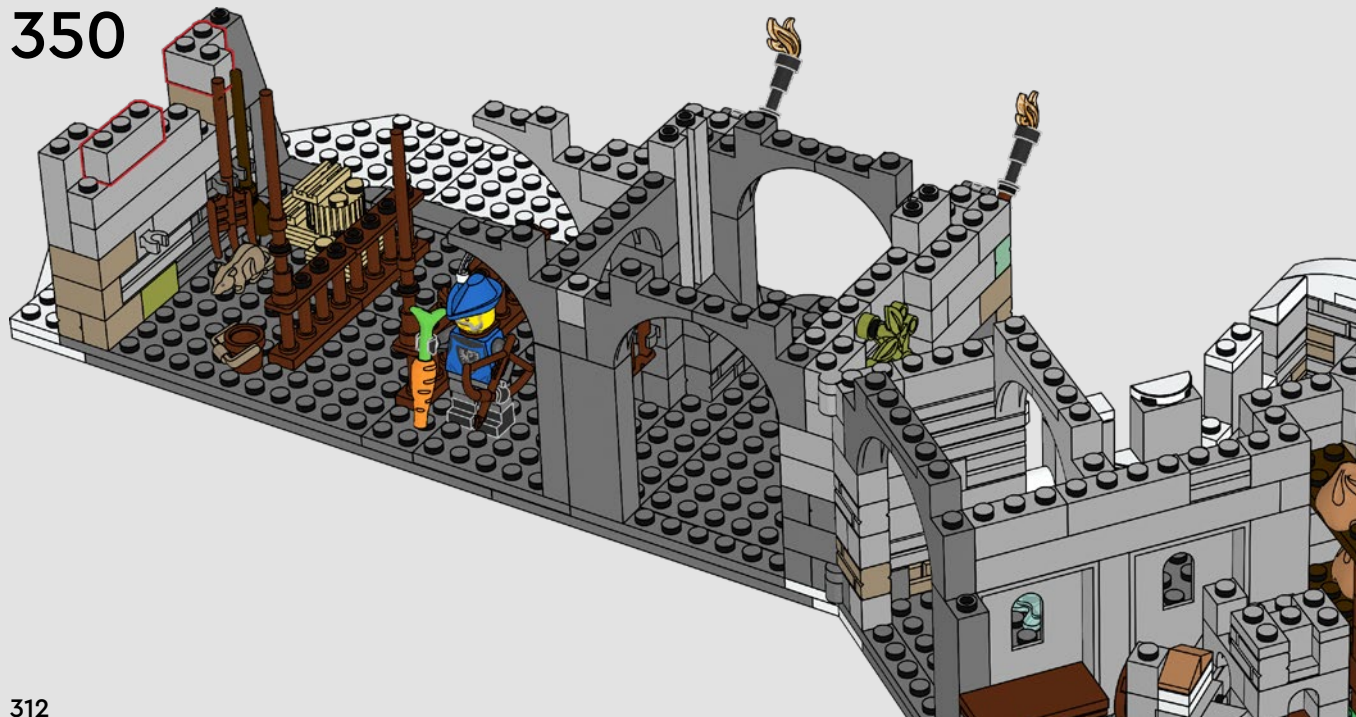

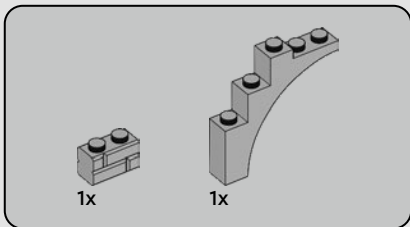

351

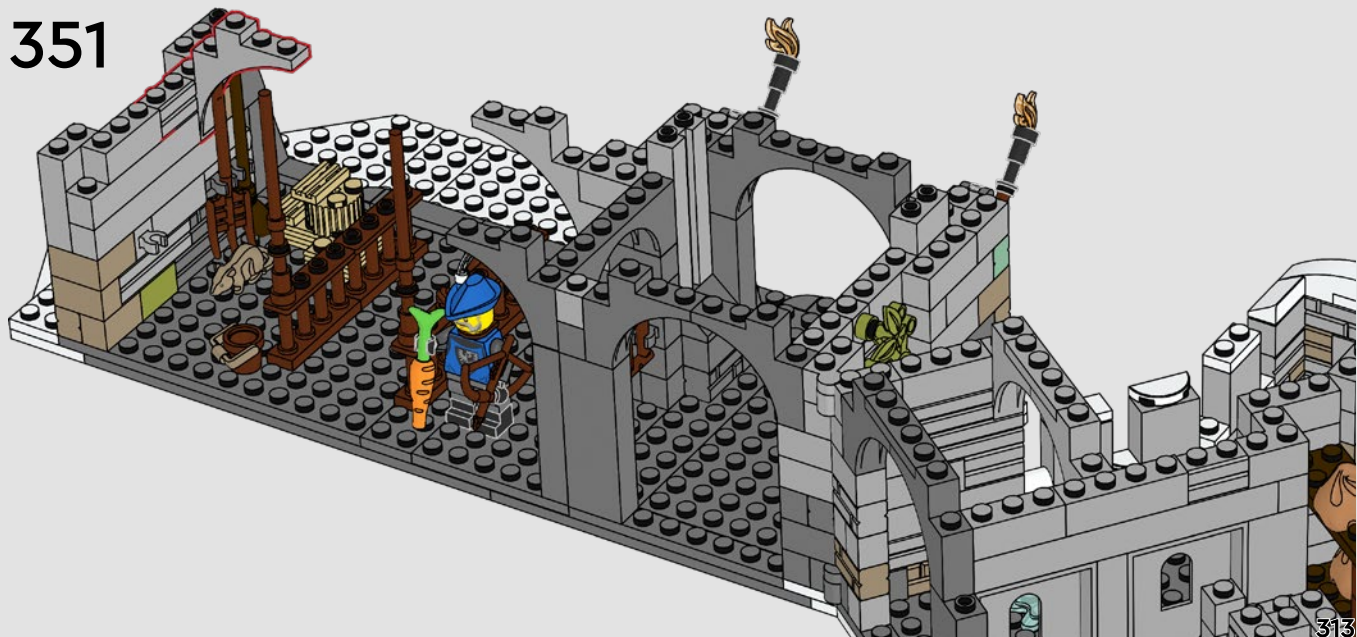

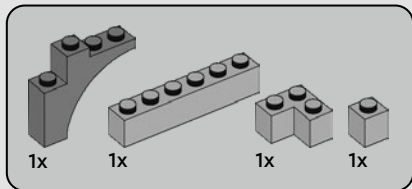

352

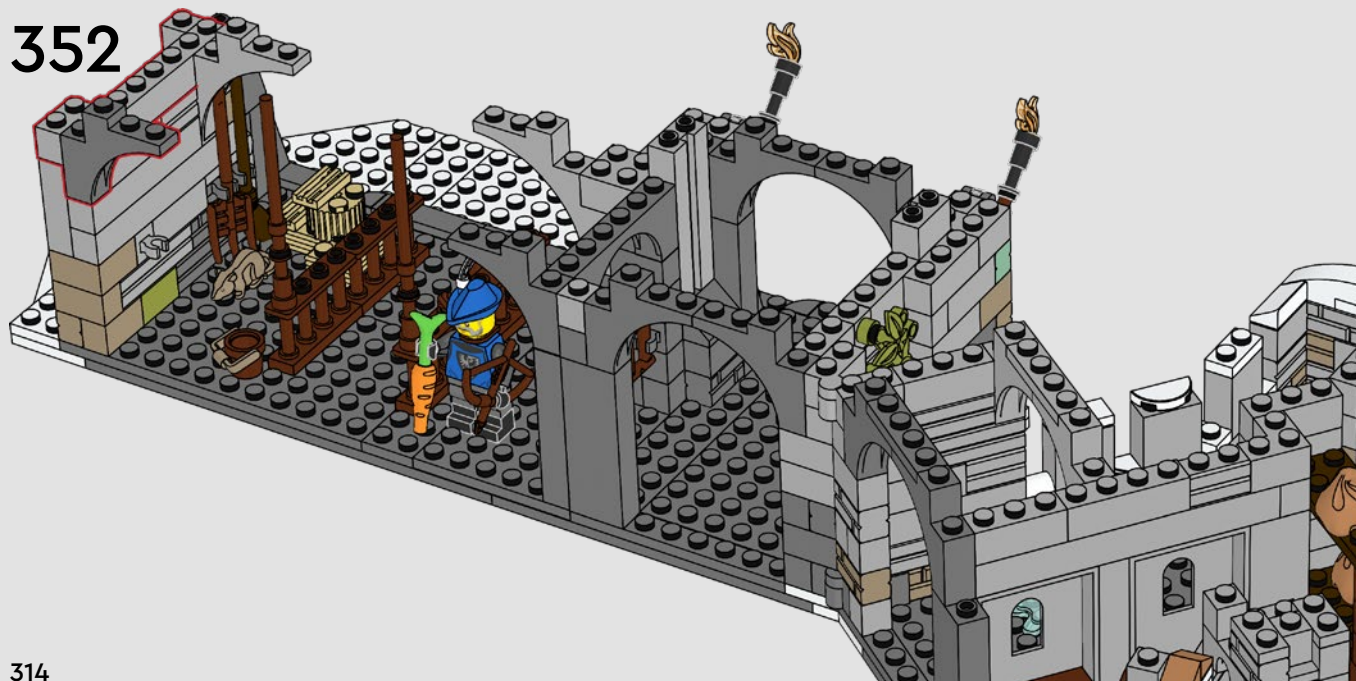

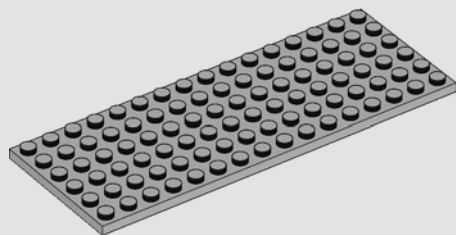
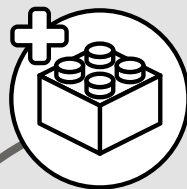
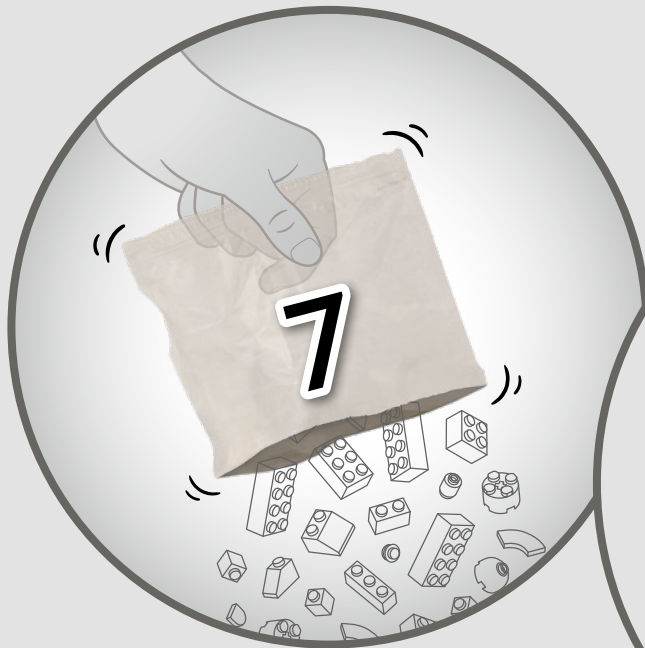

1x

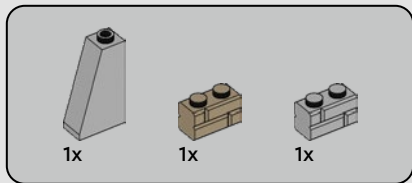

353

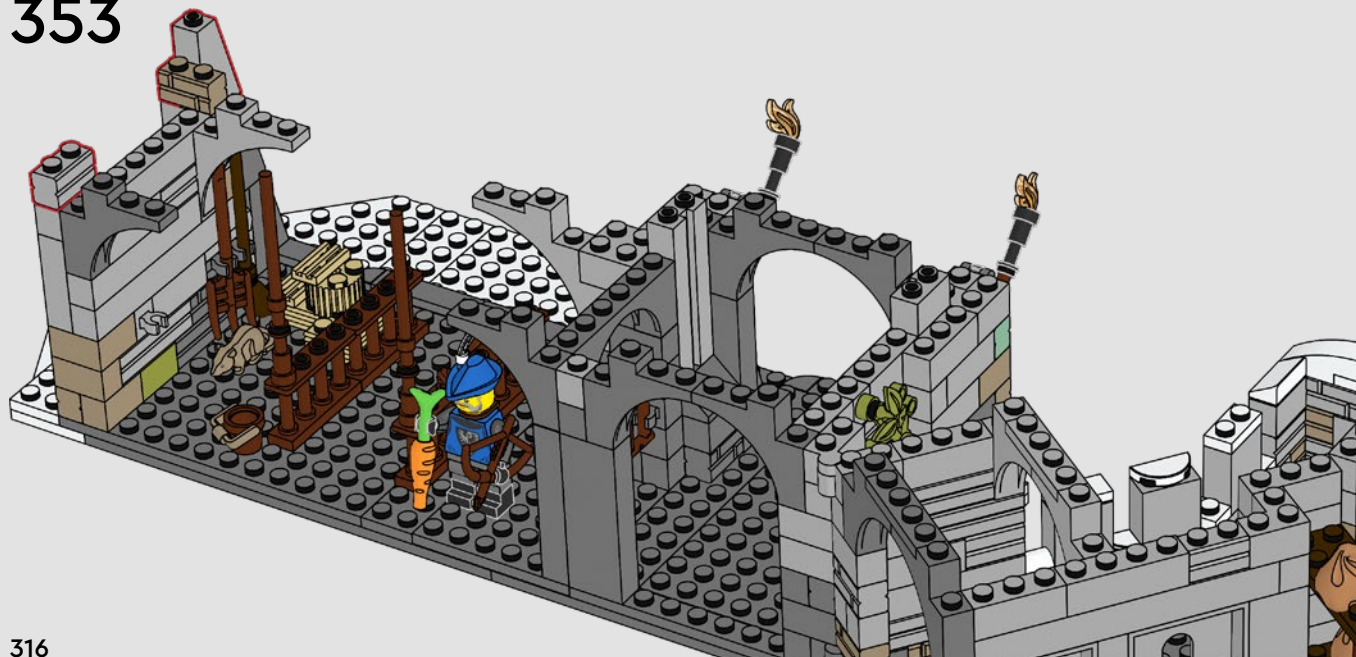

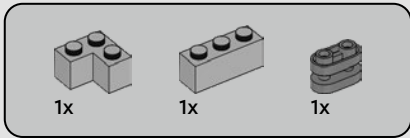

354

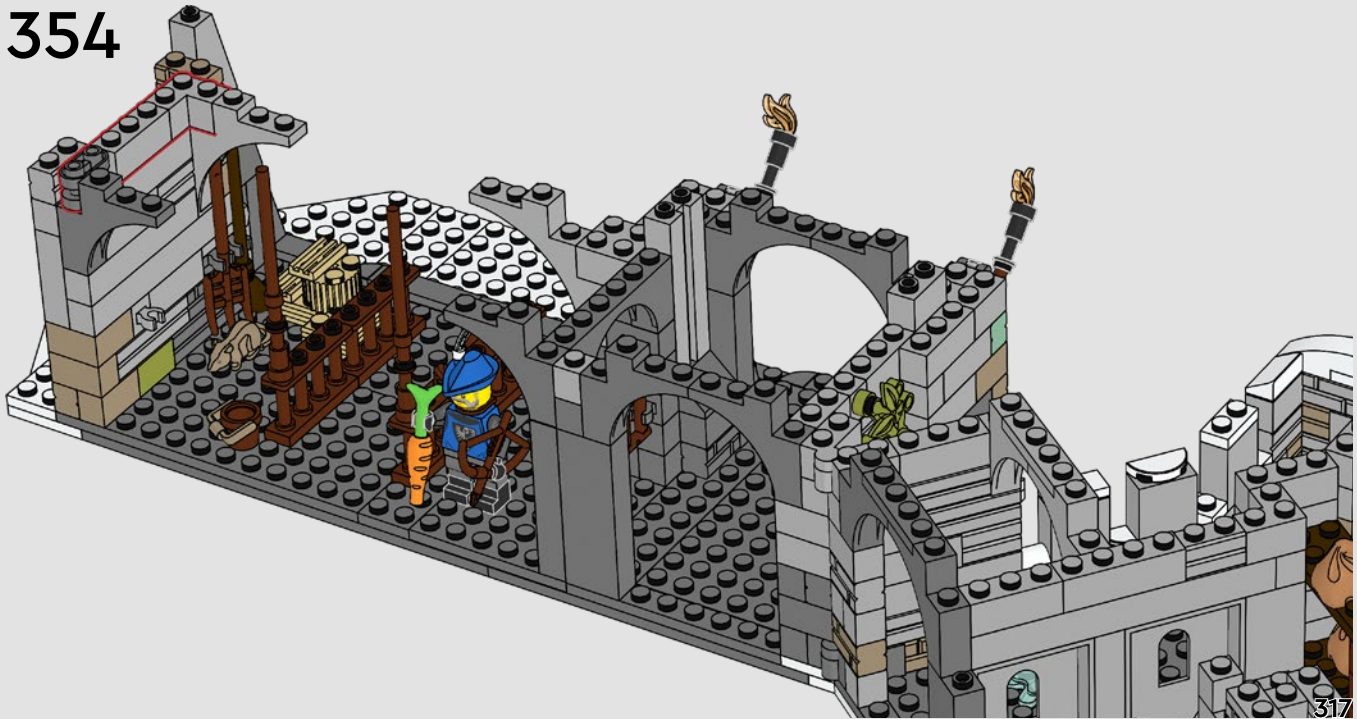

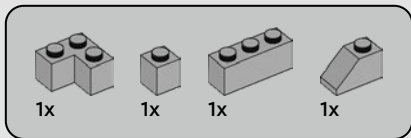

355

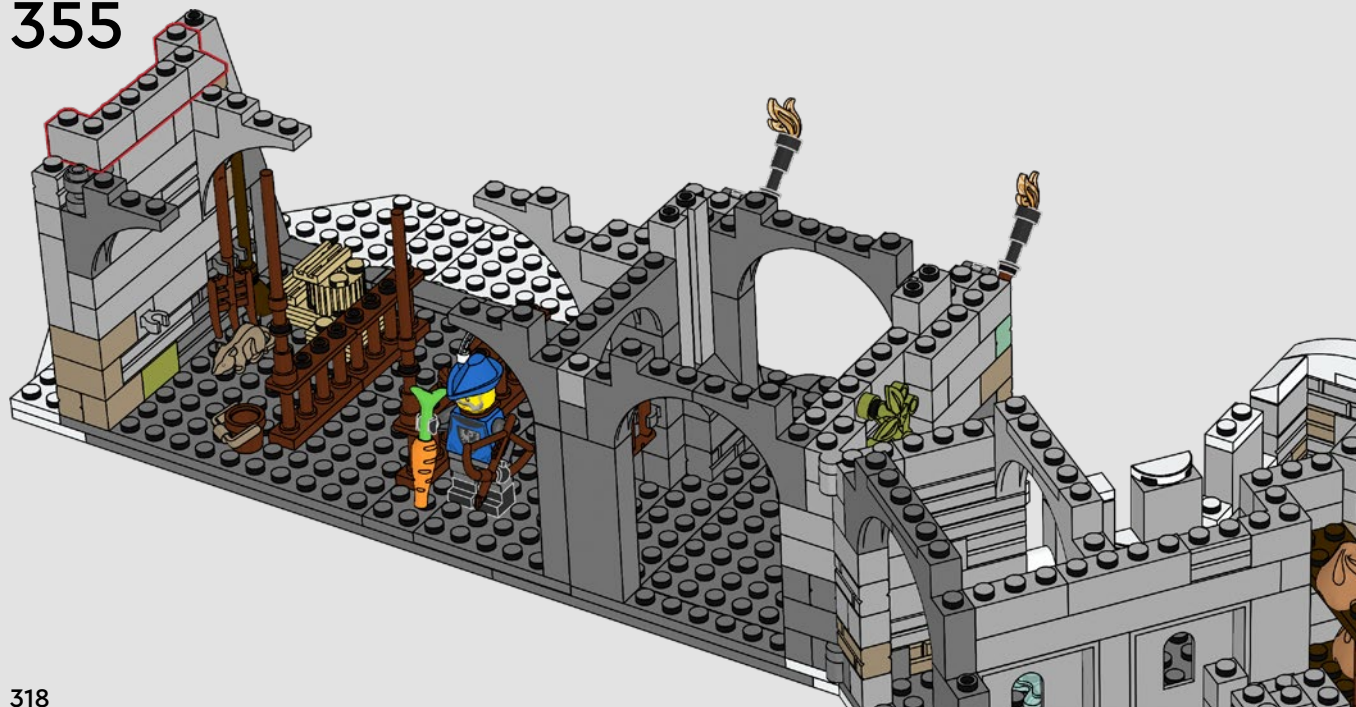

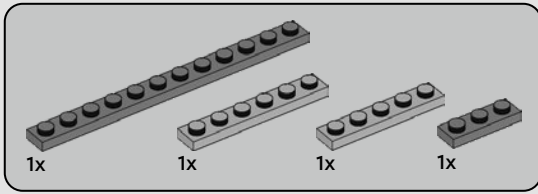

356

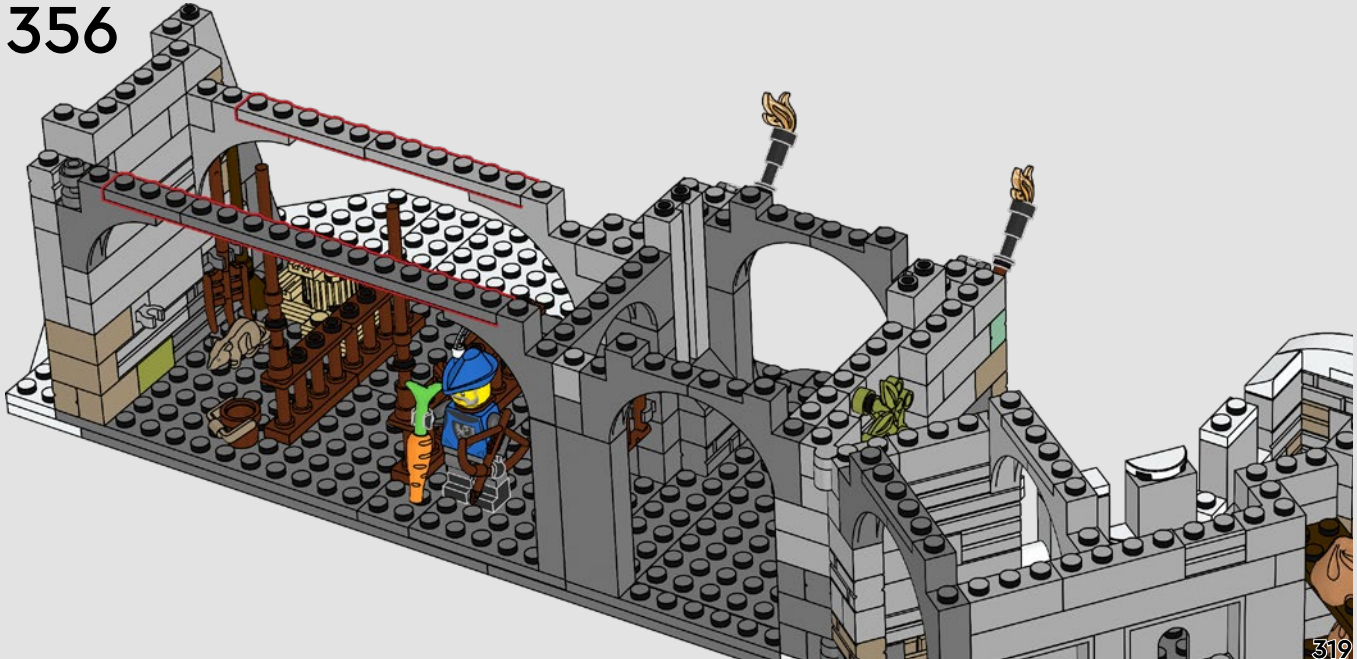

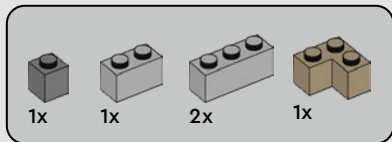

357

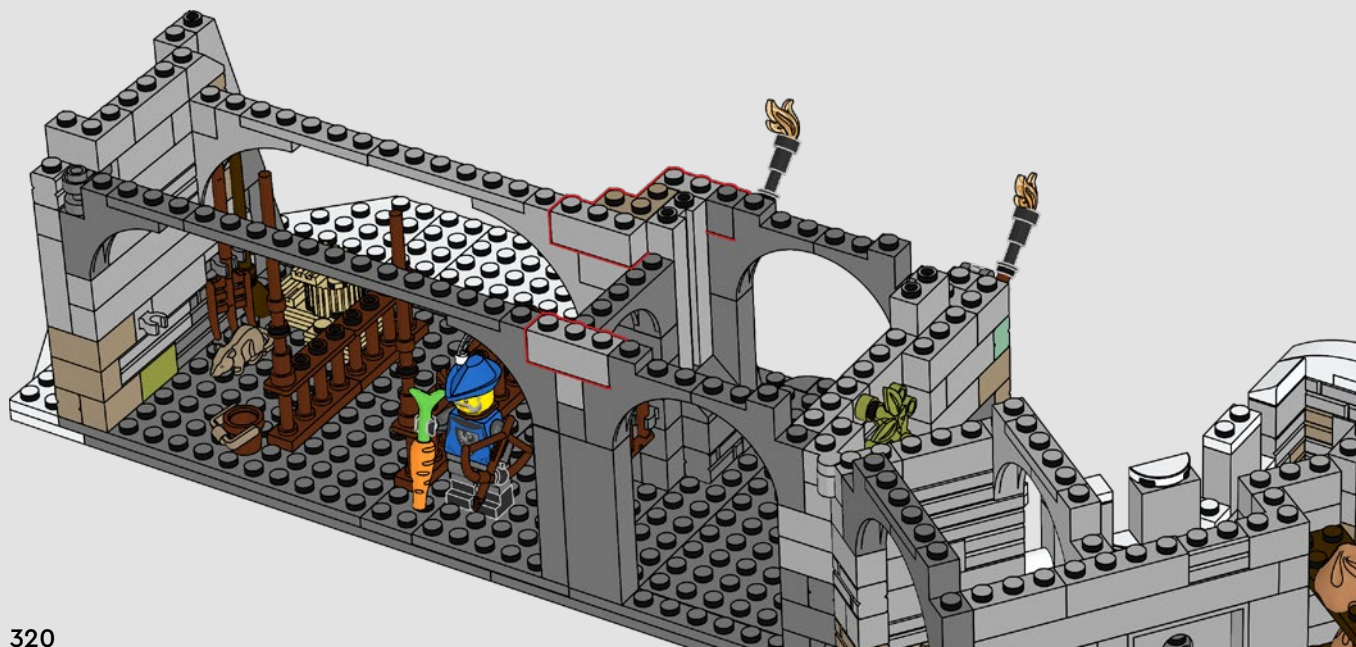

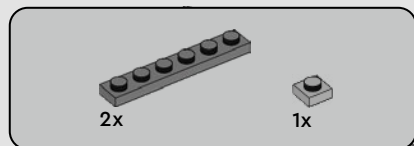

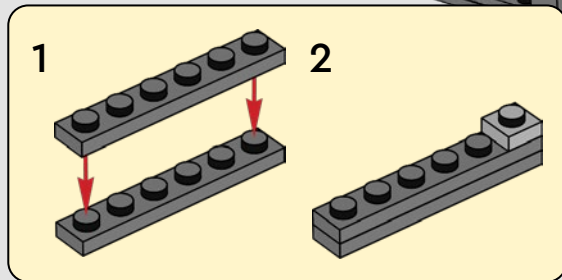
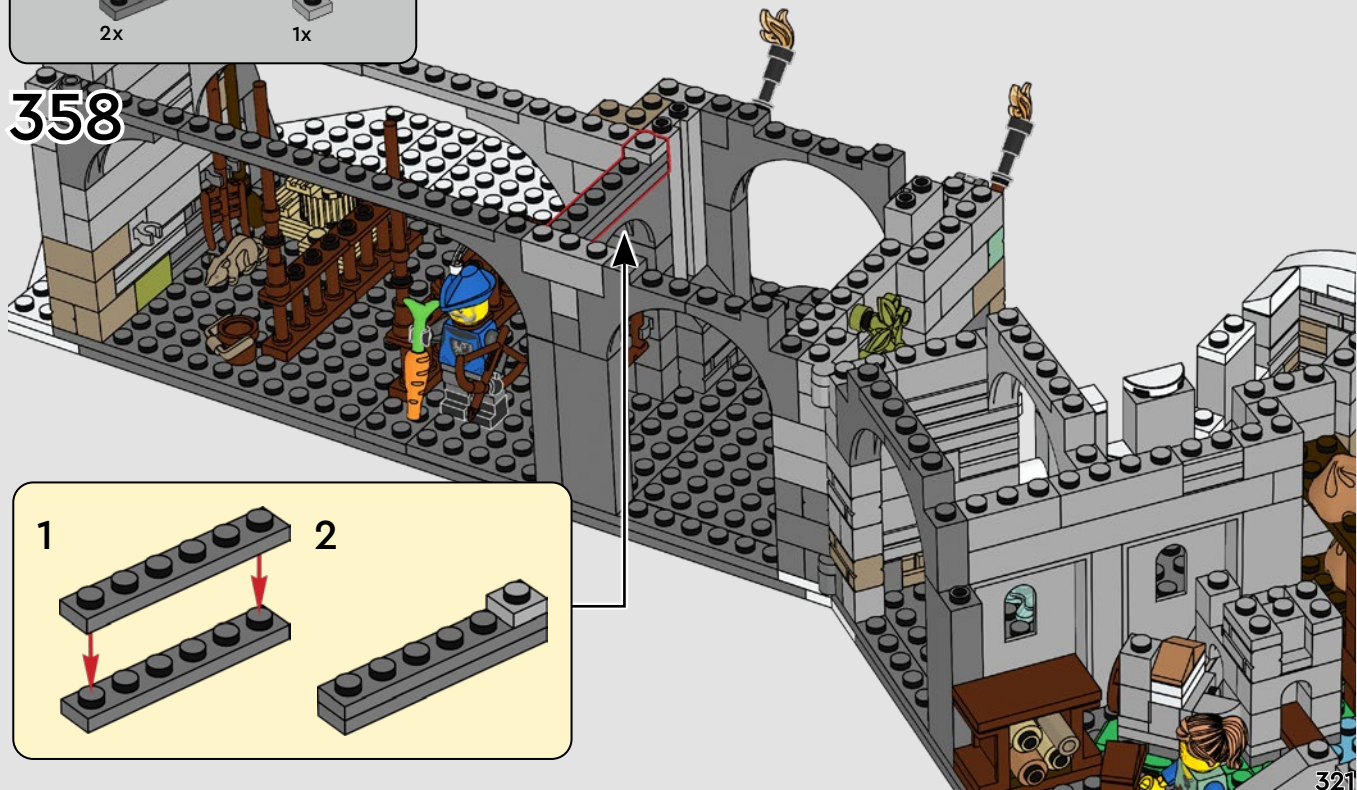

358

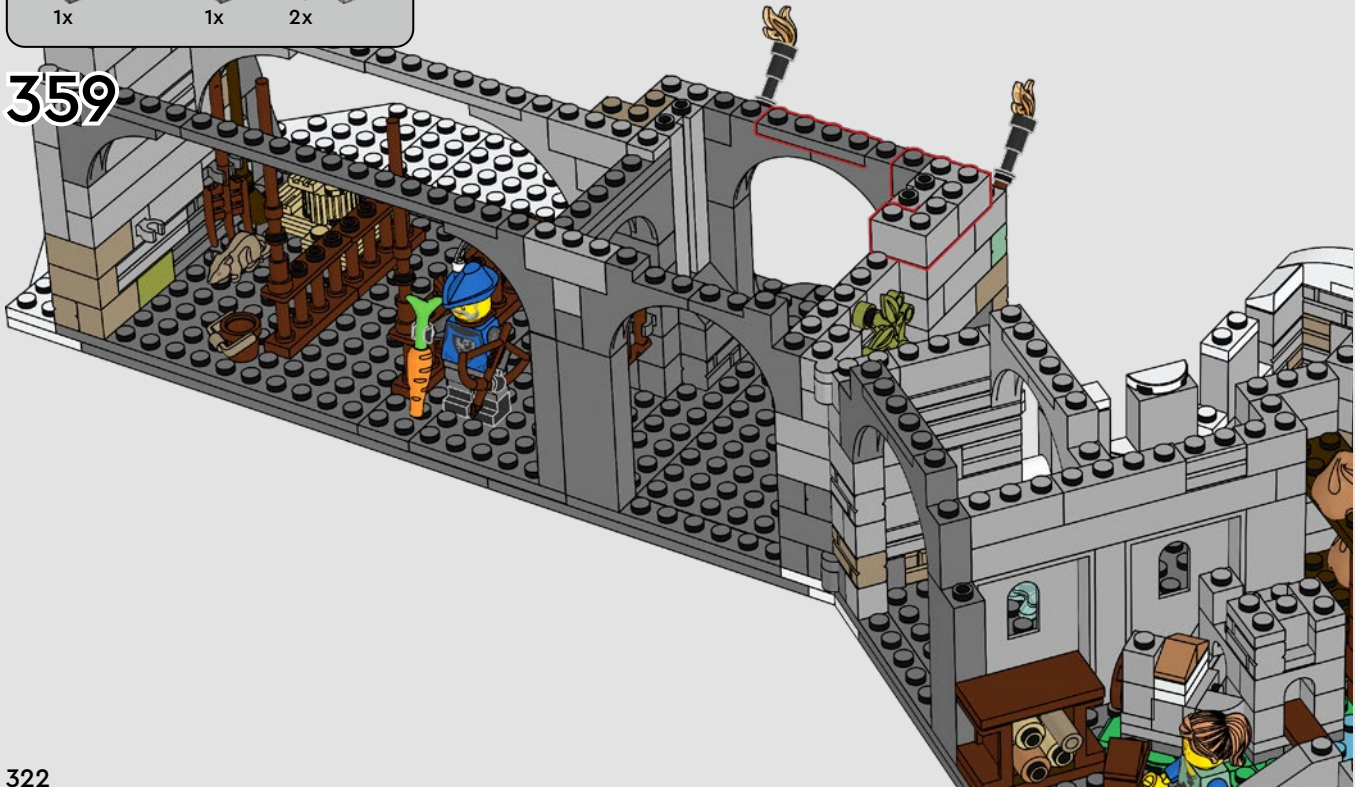

1x 1x 2x

359



1x  1x 

360



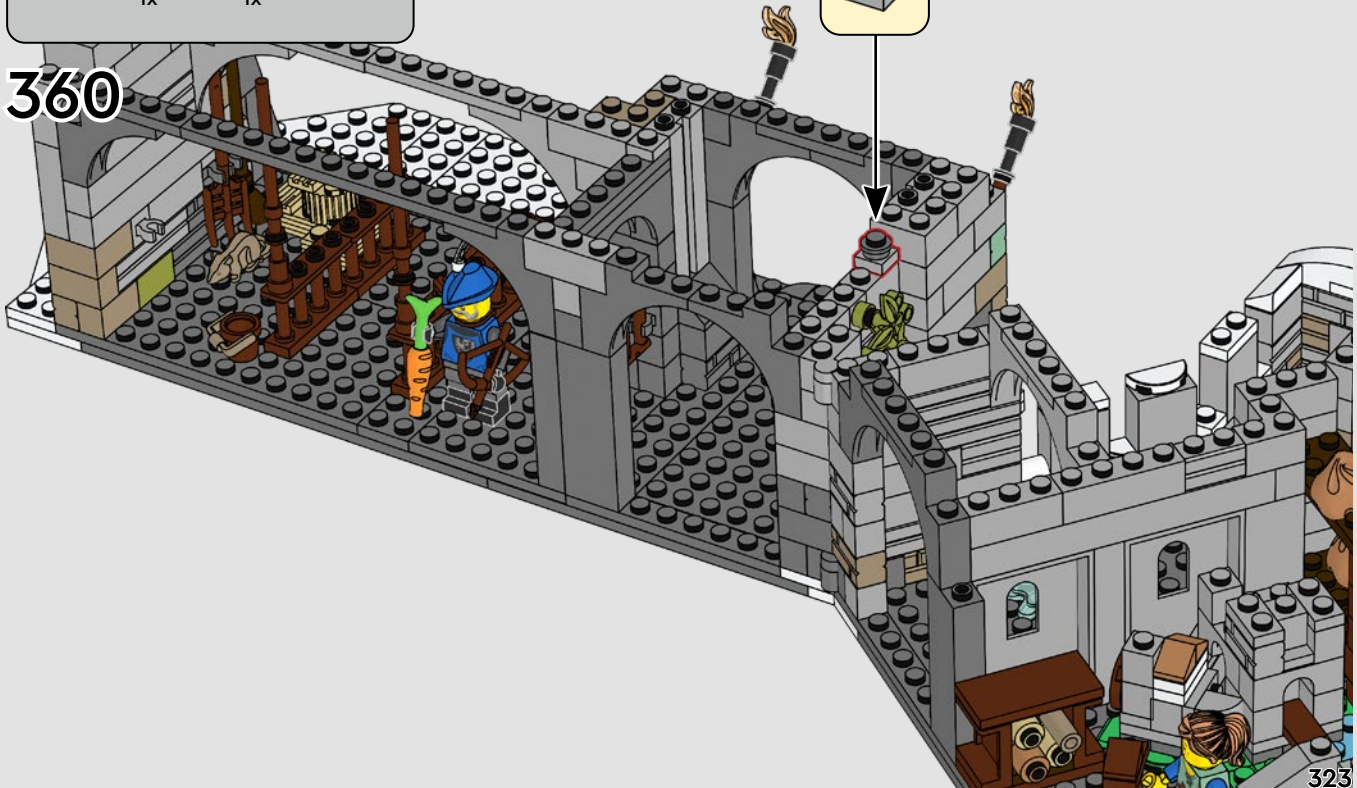

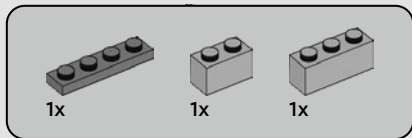

361

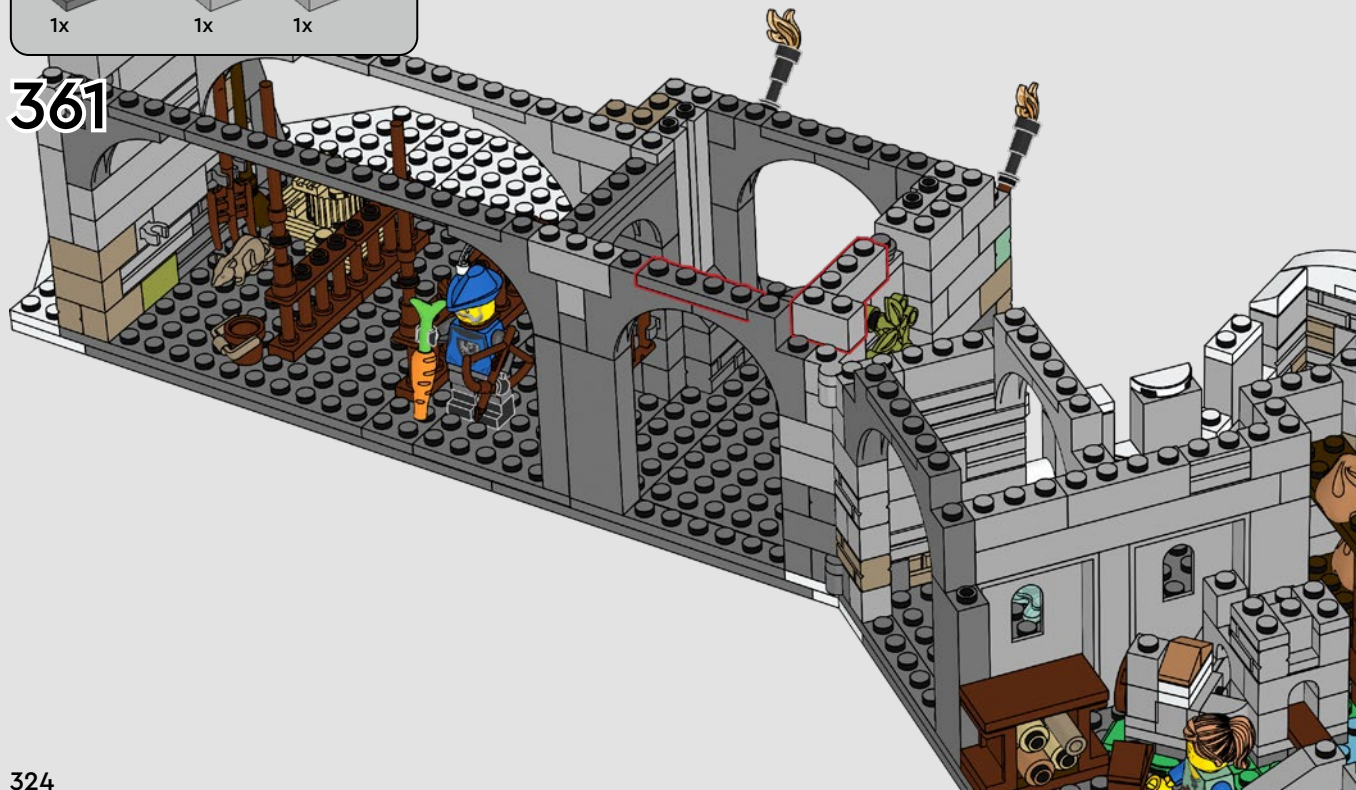



1x



1x

362

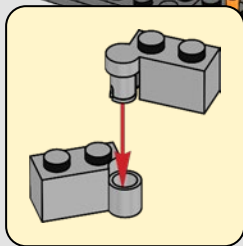
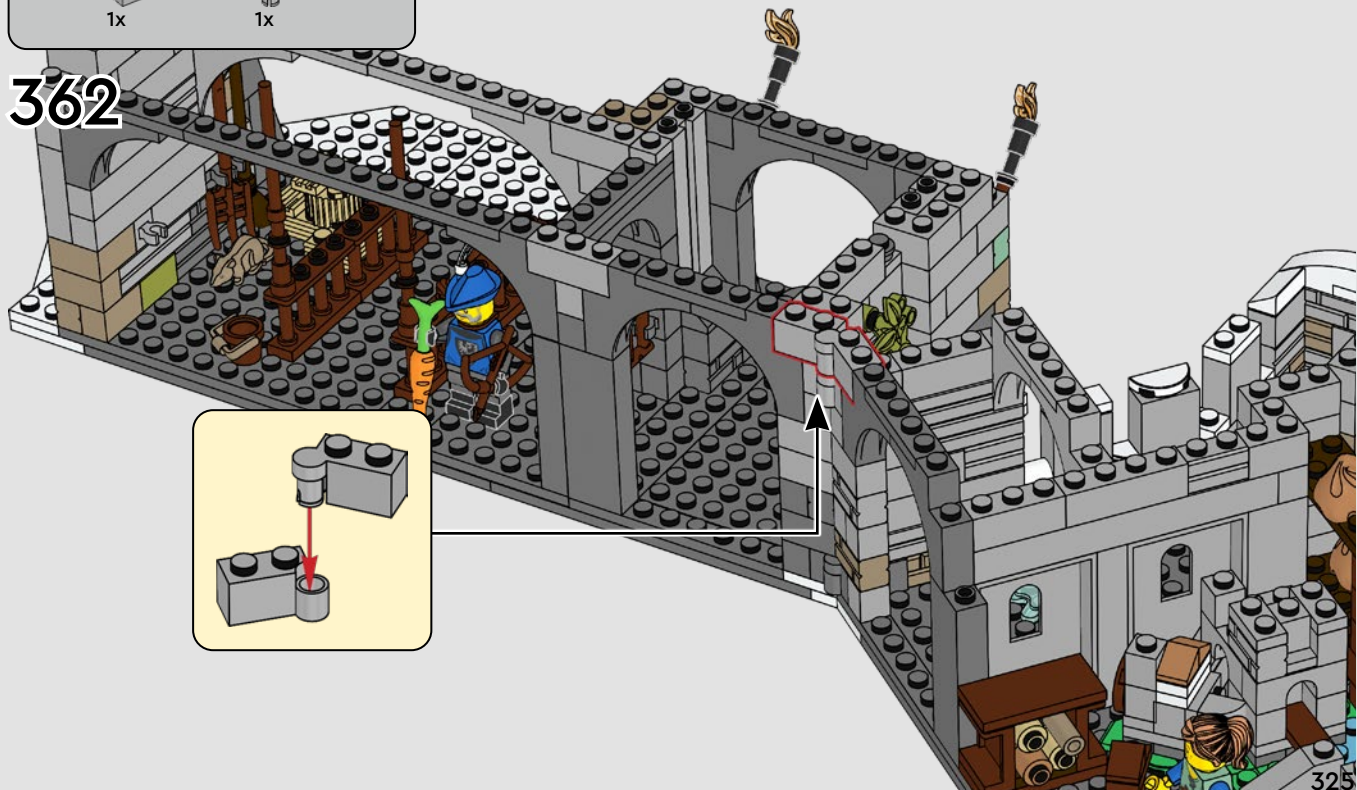

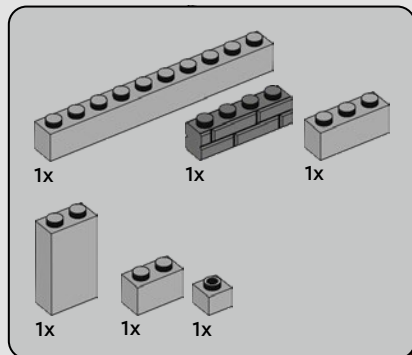

363

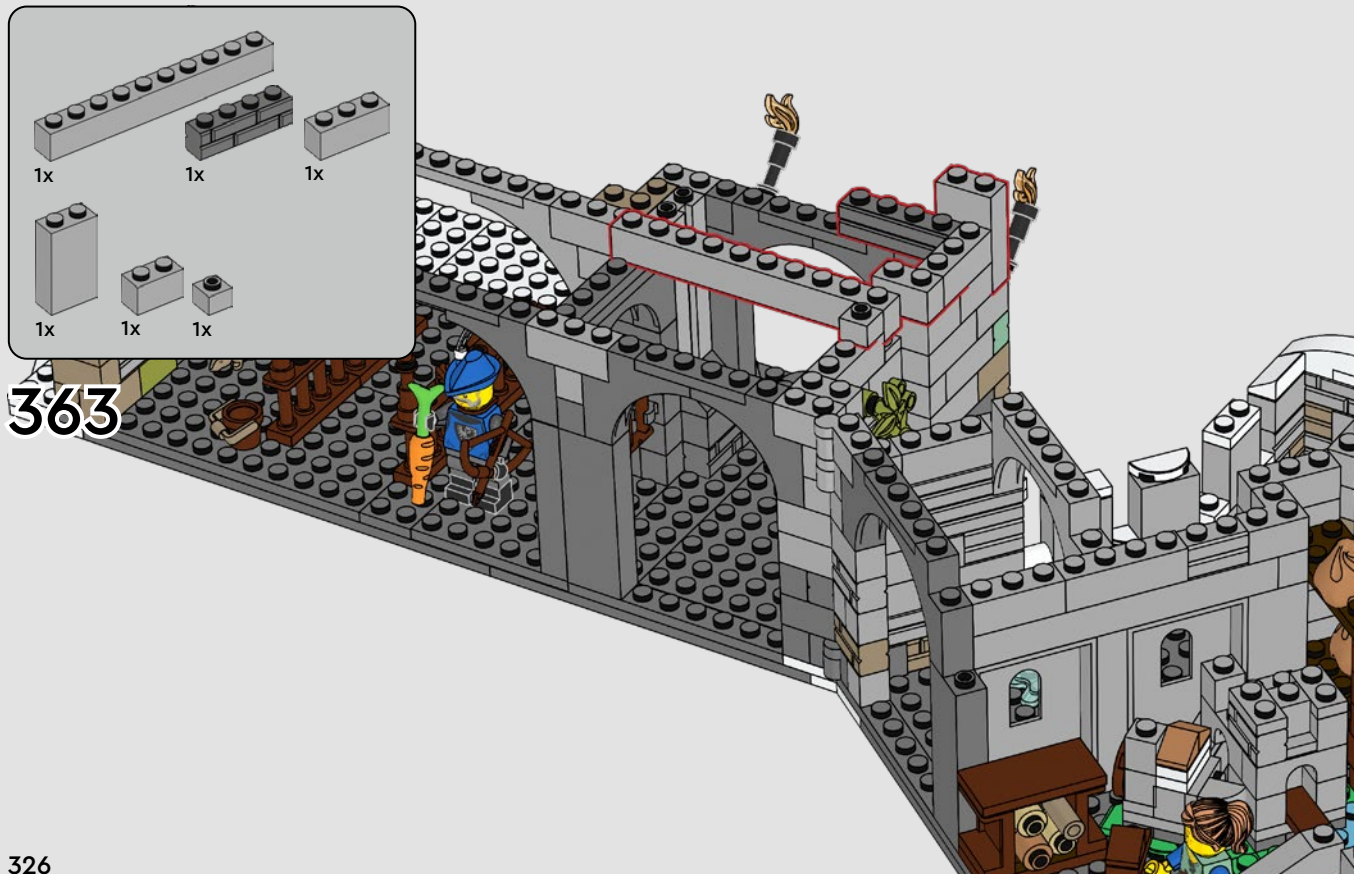

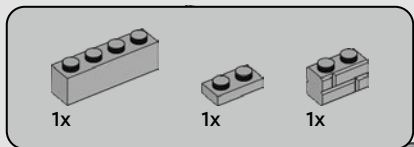

364

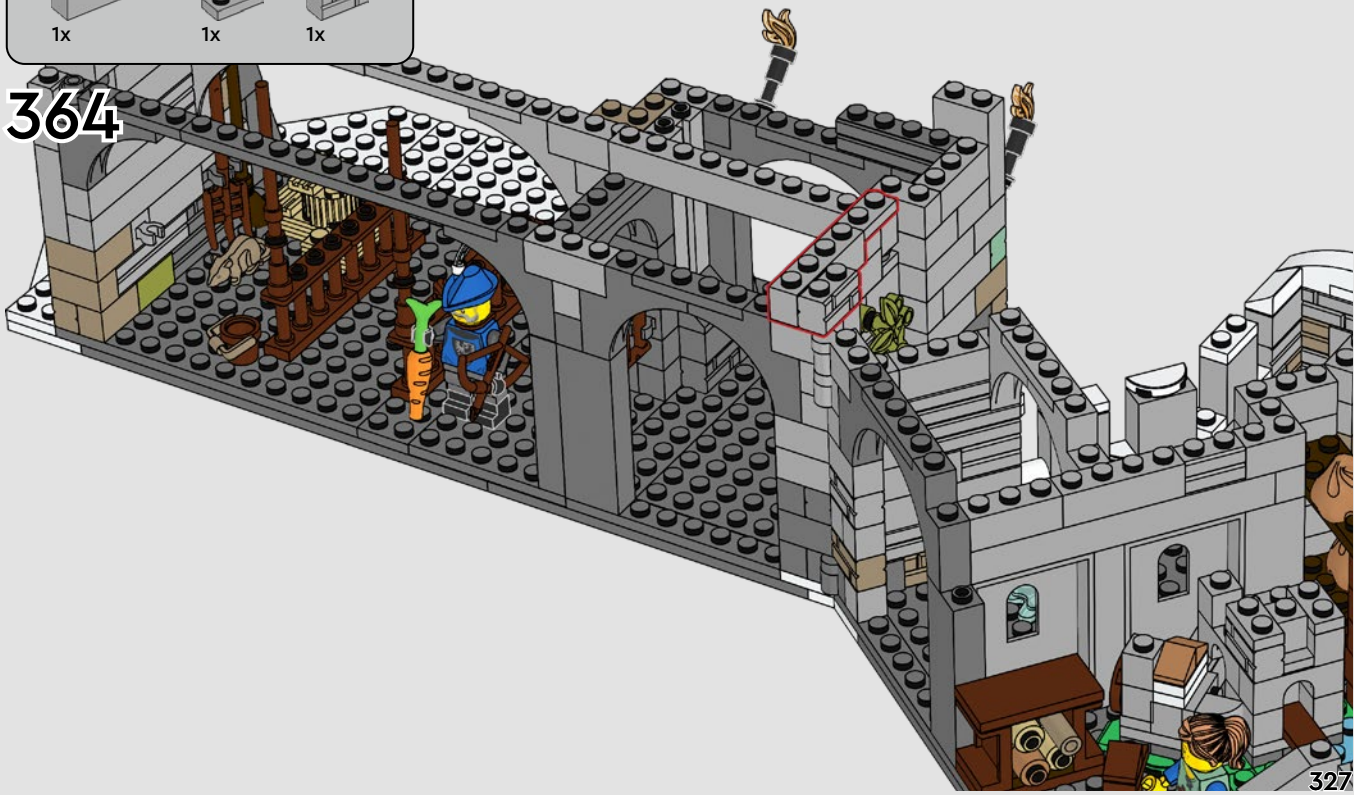

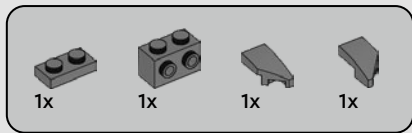

365

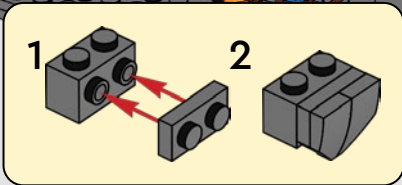
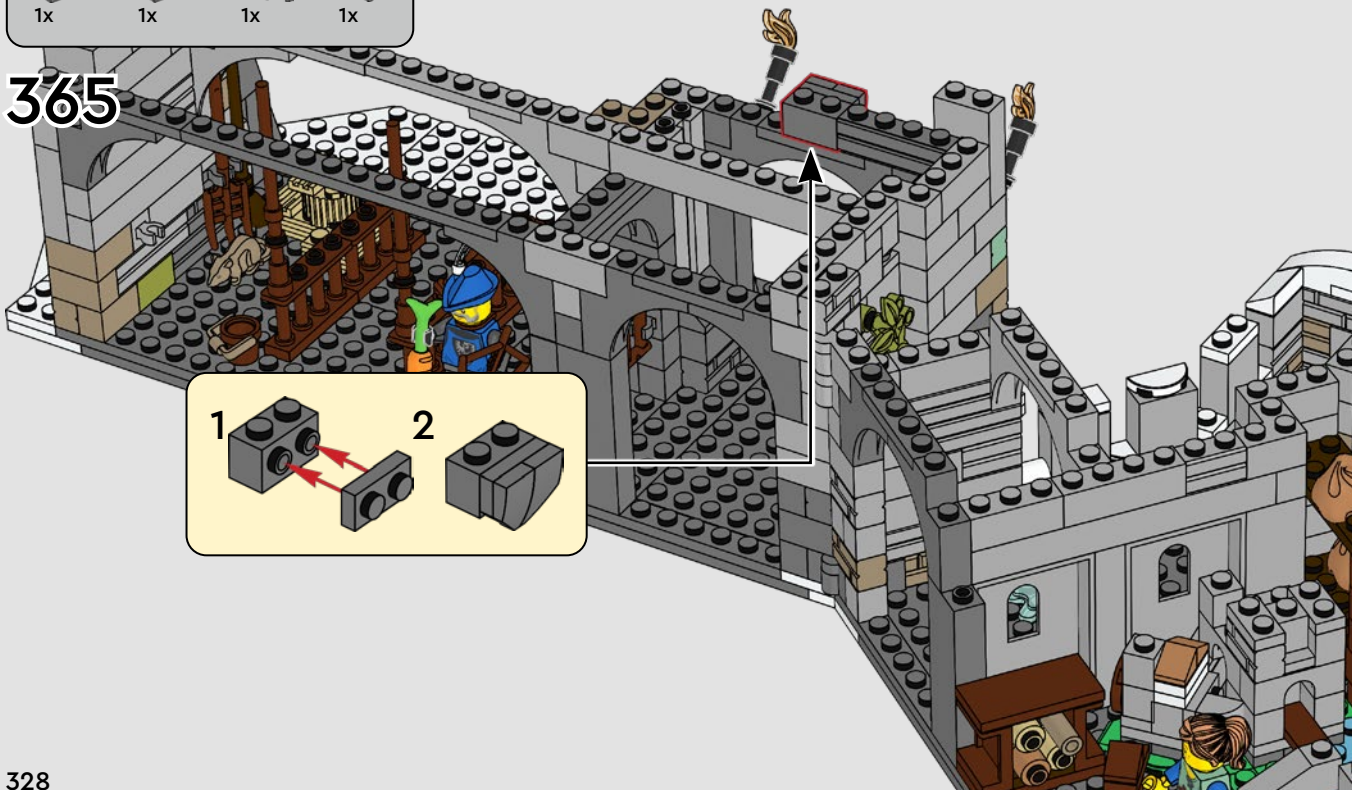



1x



1x

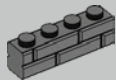

1x

366

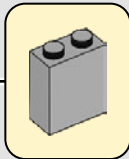

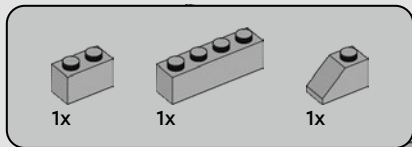

367

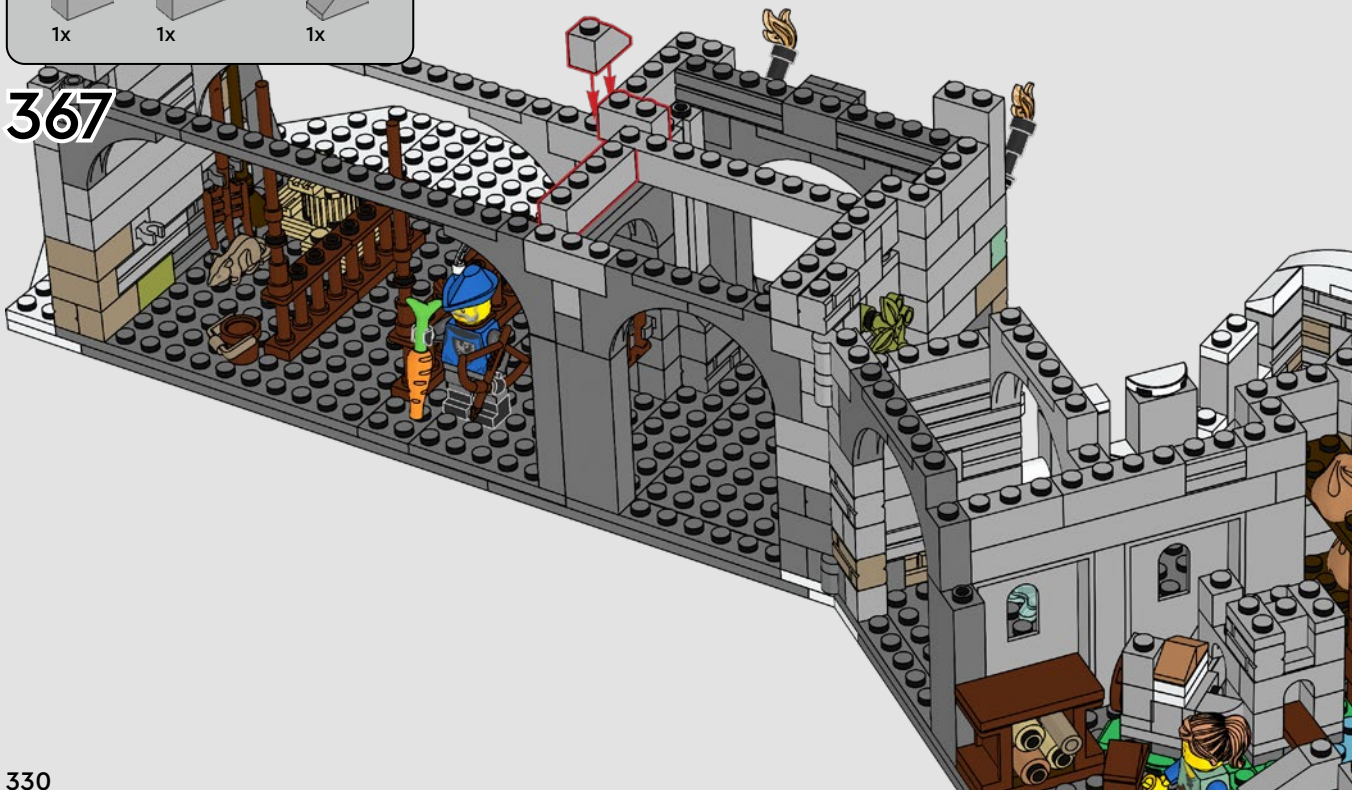

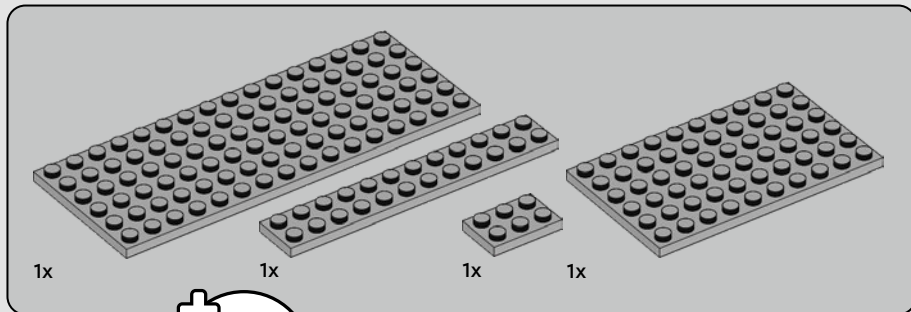
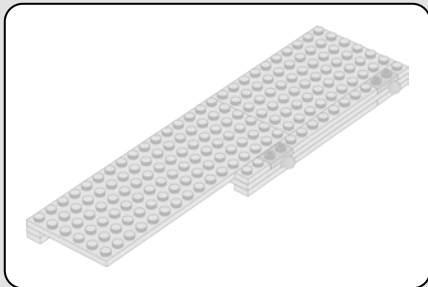

368

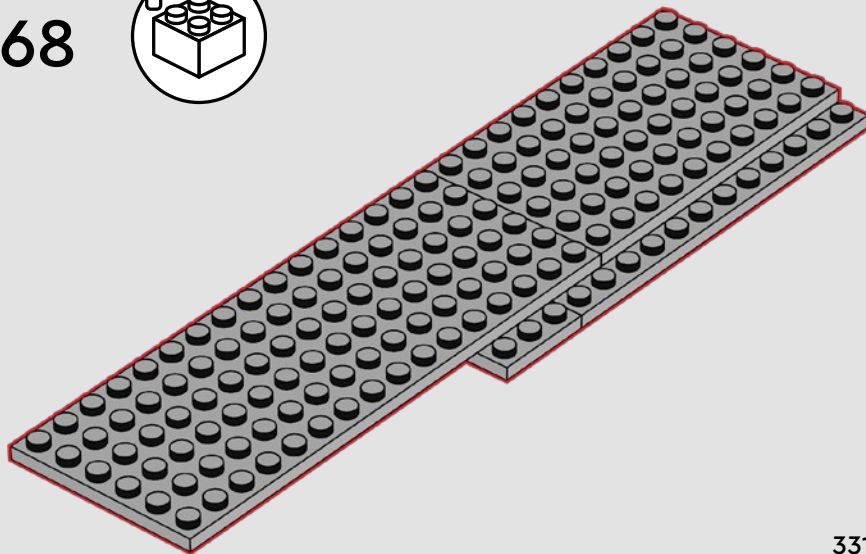

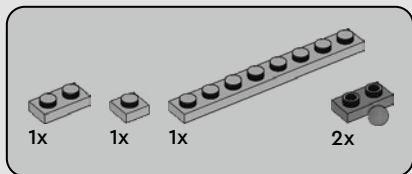

369

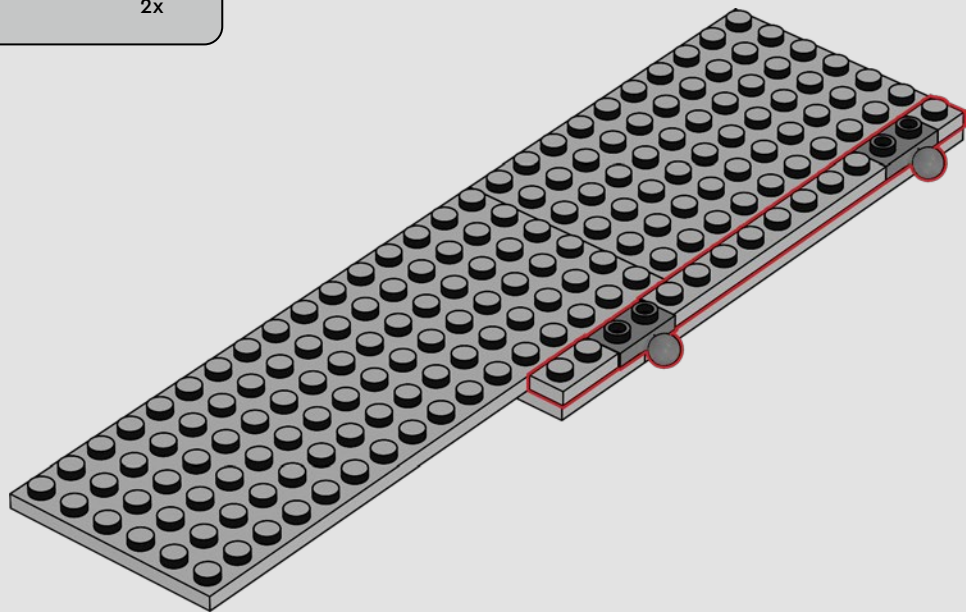

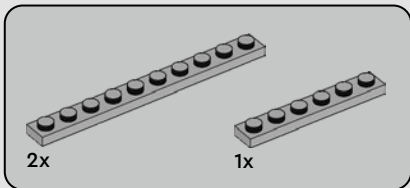

370

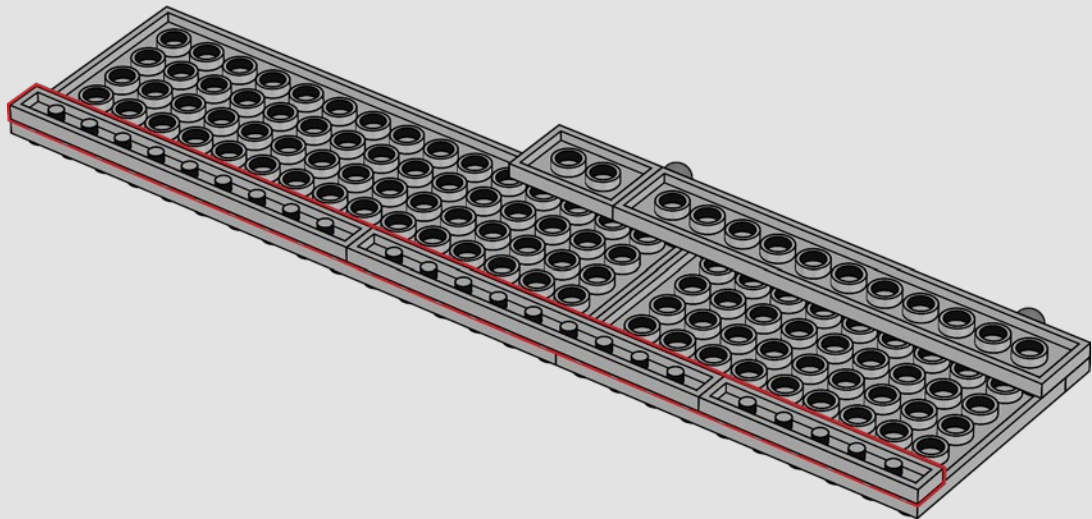

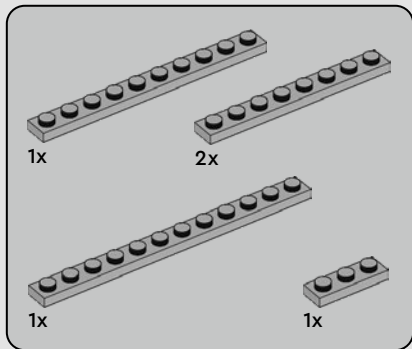

371

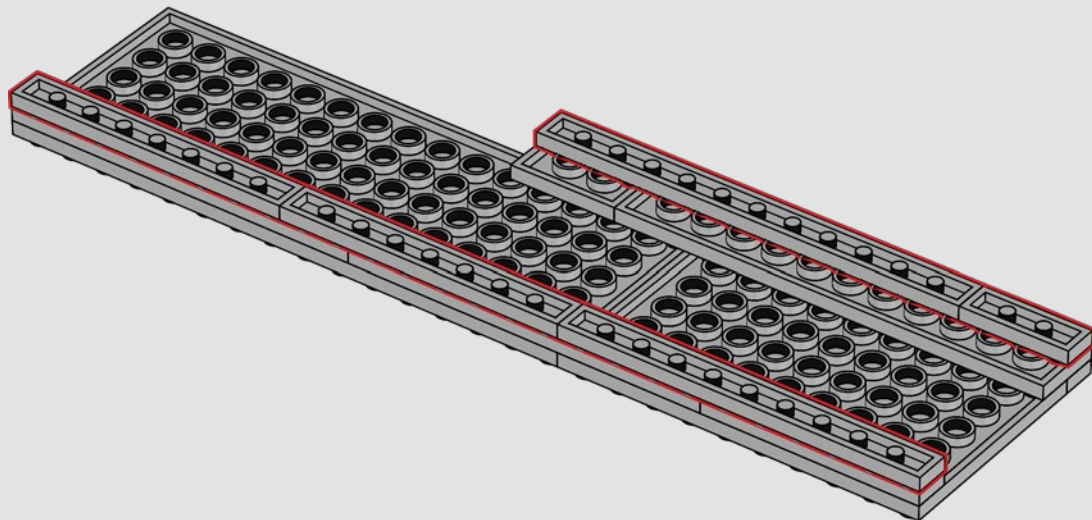

372



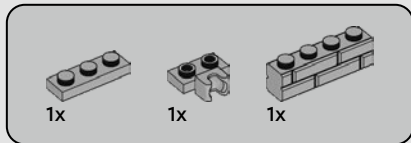
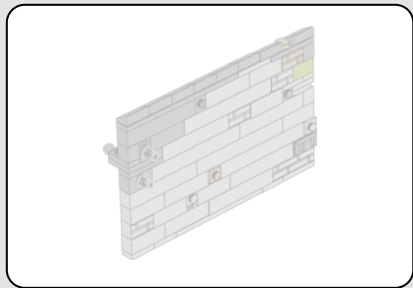

373

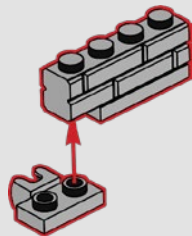

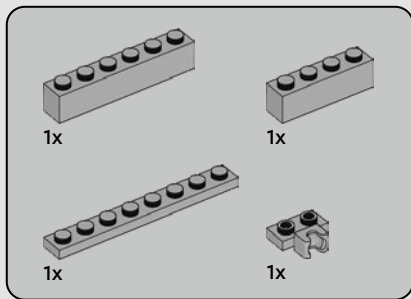

374

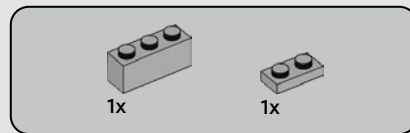
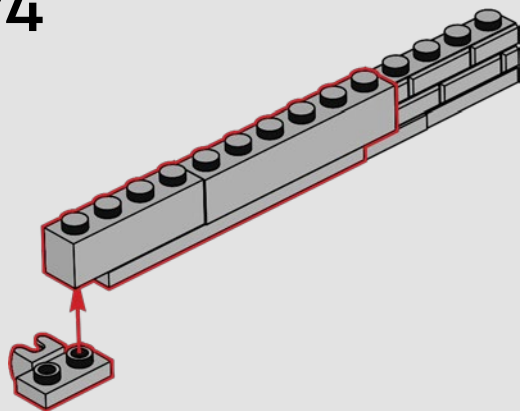

375

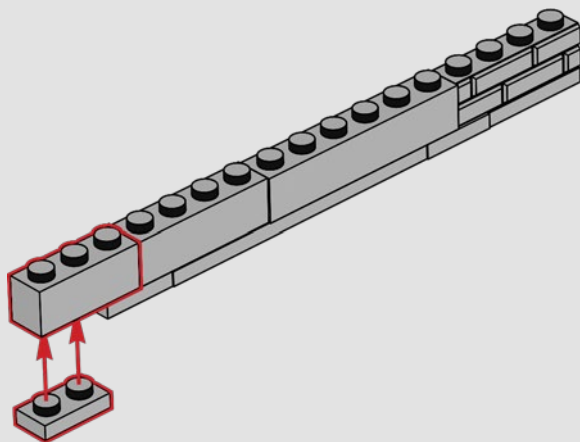

1x



1x

376

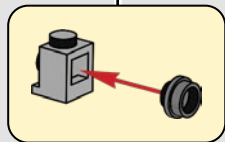
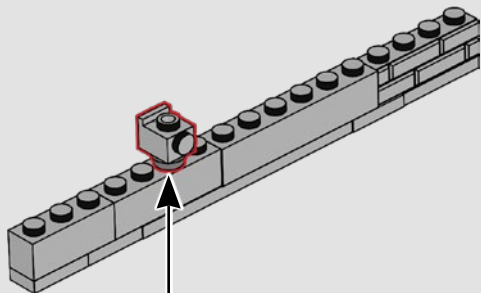

338

1x

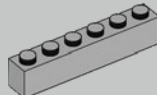

2x



1x



377

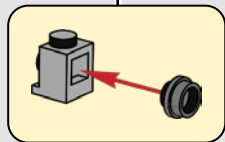
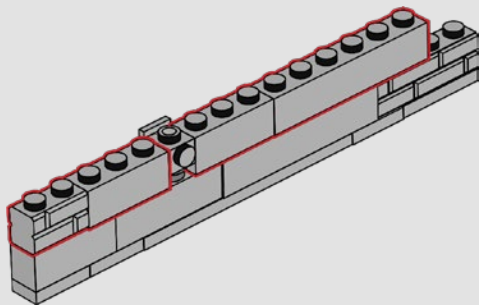

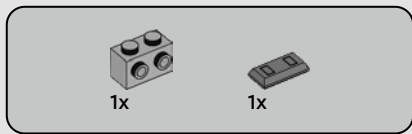

378

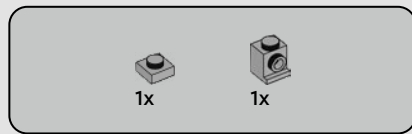
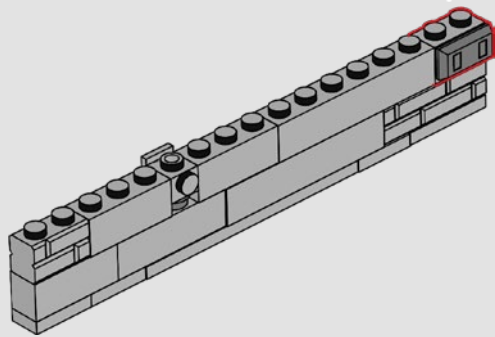
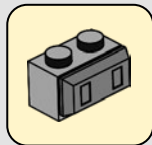

379

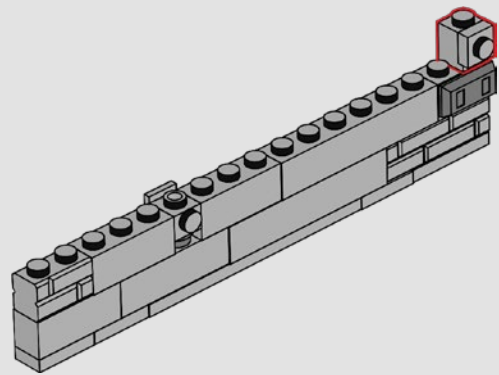
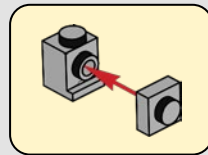

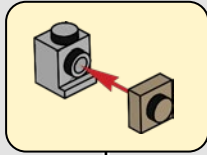
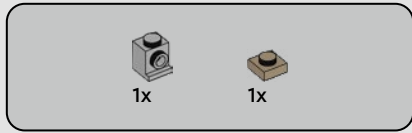

380

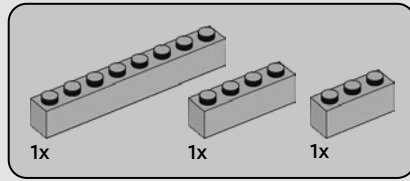
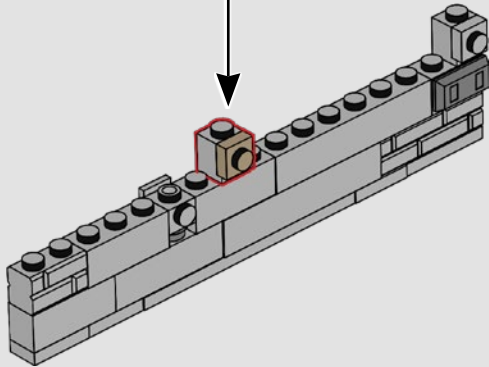

381

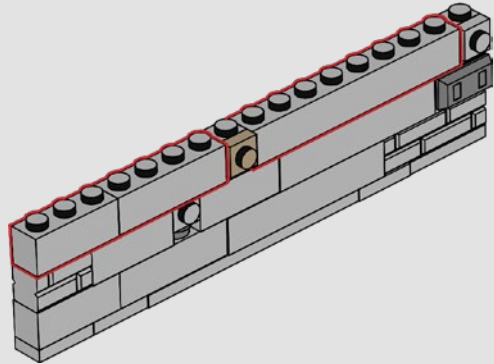

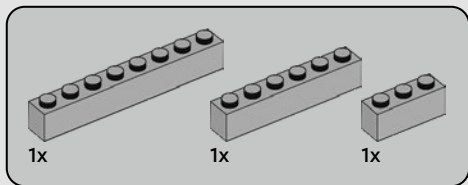

382

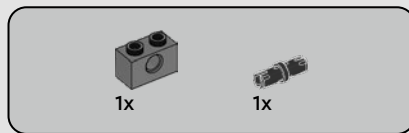
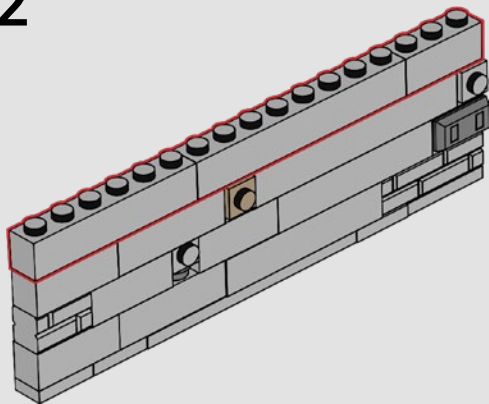

383

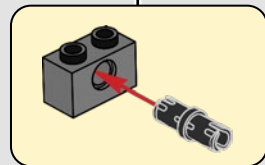
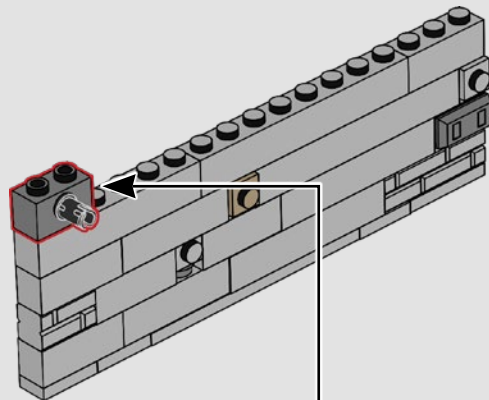

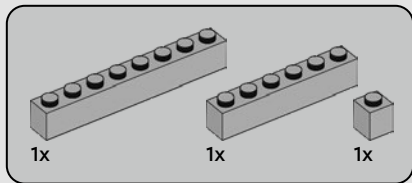

384

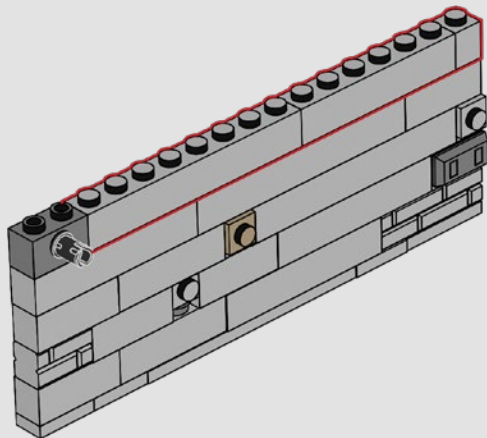

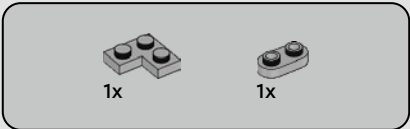
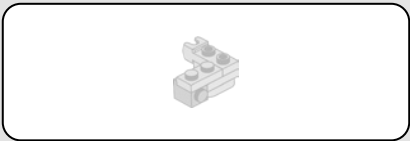

385

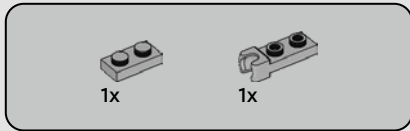
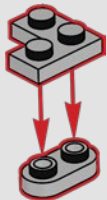

386

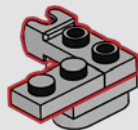



1x

387

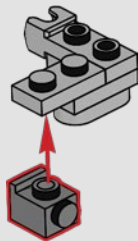

388

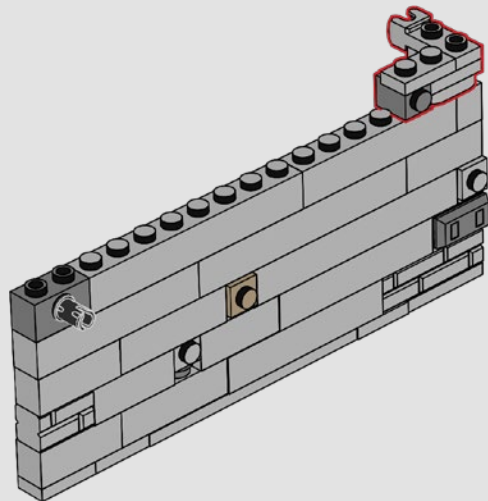

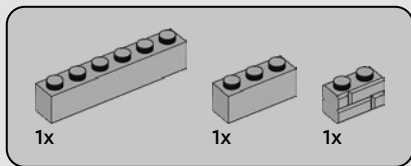

389

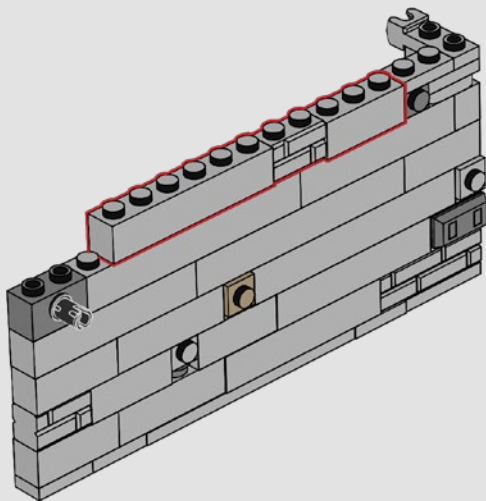

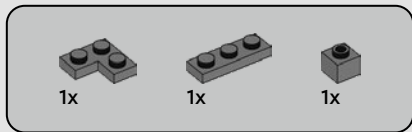

390

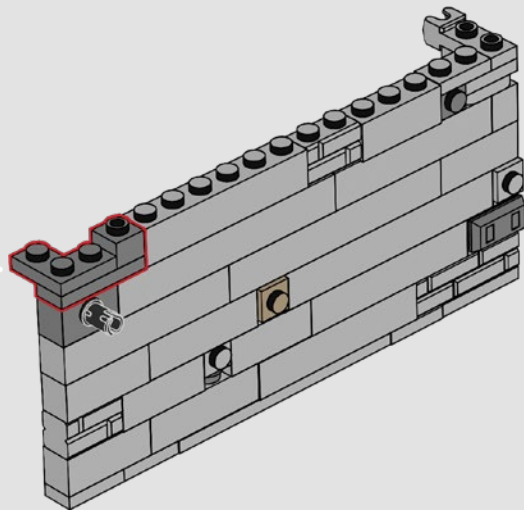
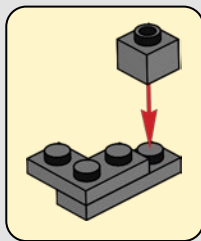

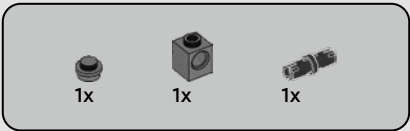

391

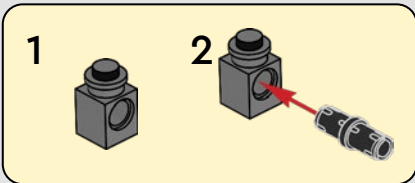
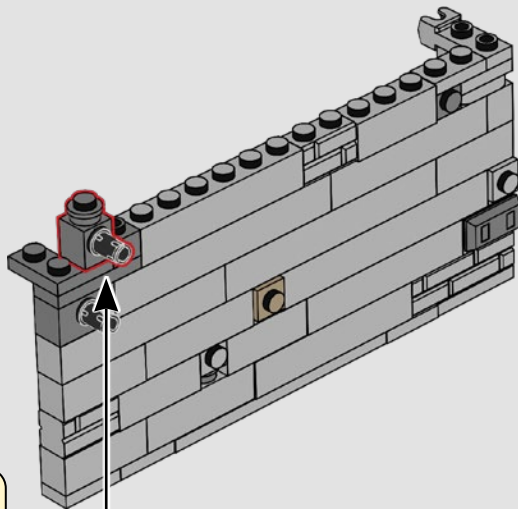

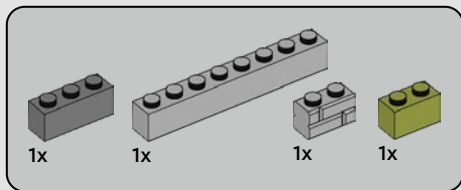

392

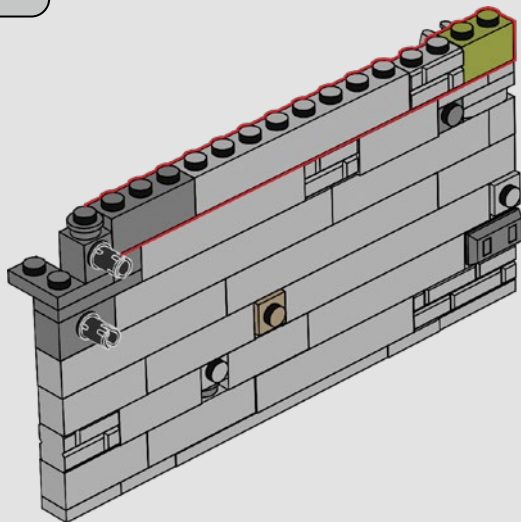



1x



1x

393

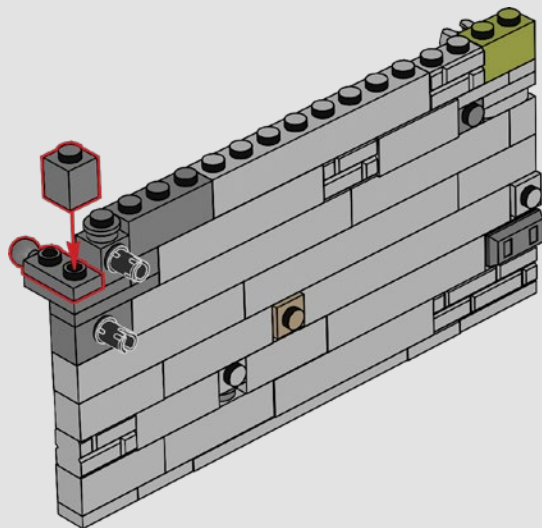

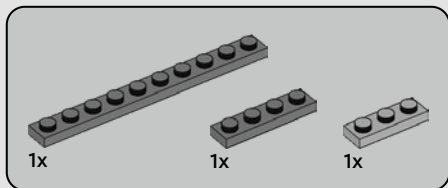

395

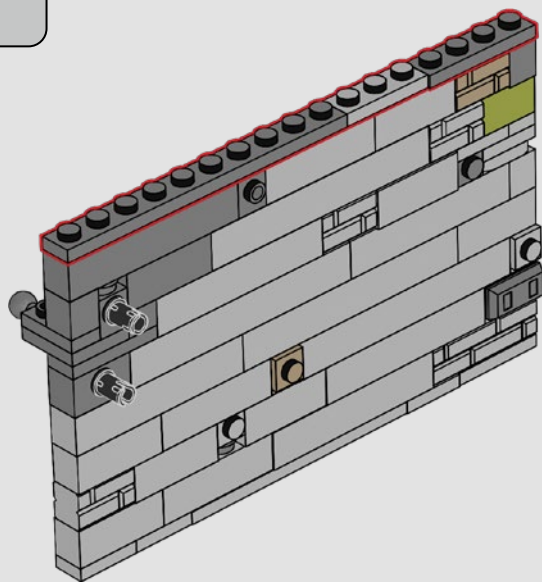



8x



1x

396

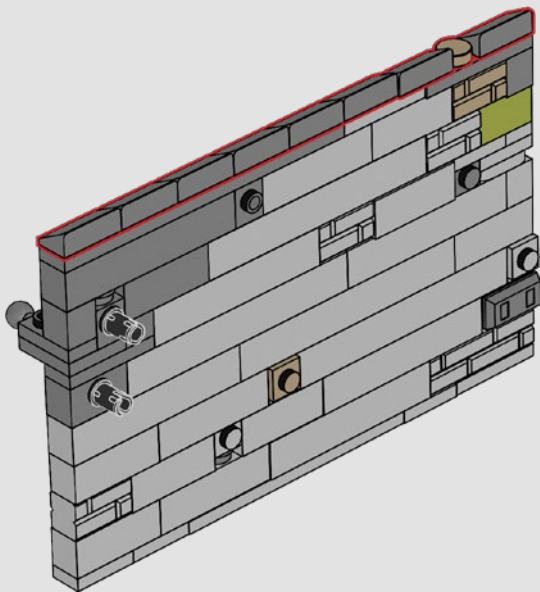

397

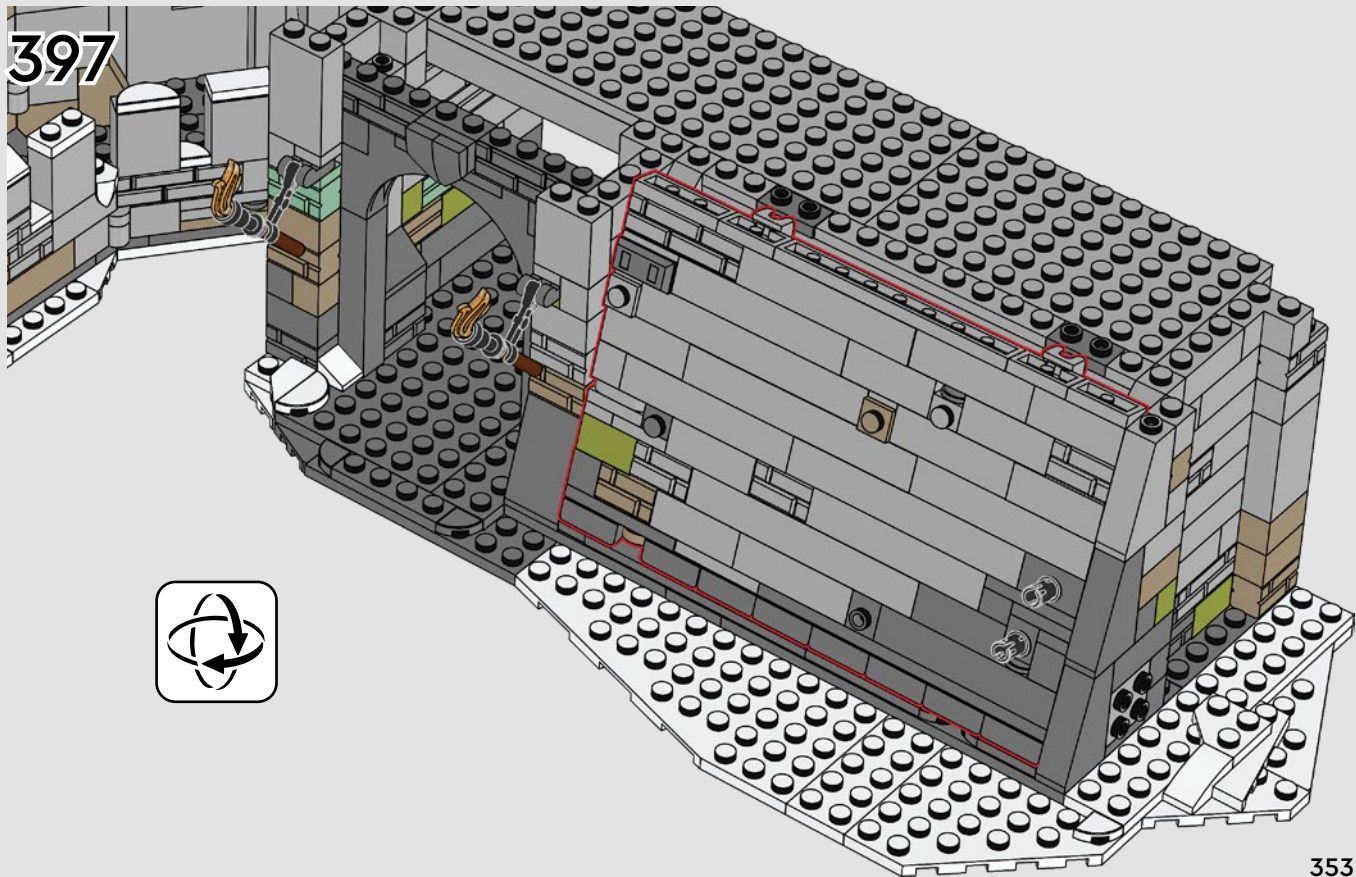

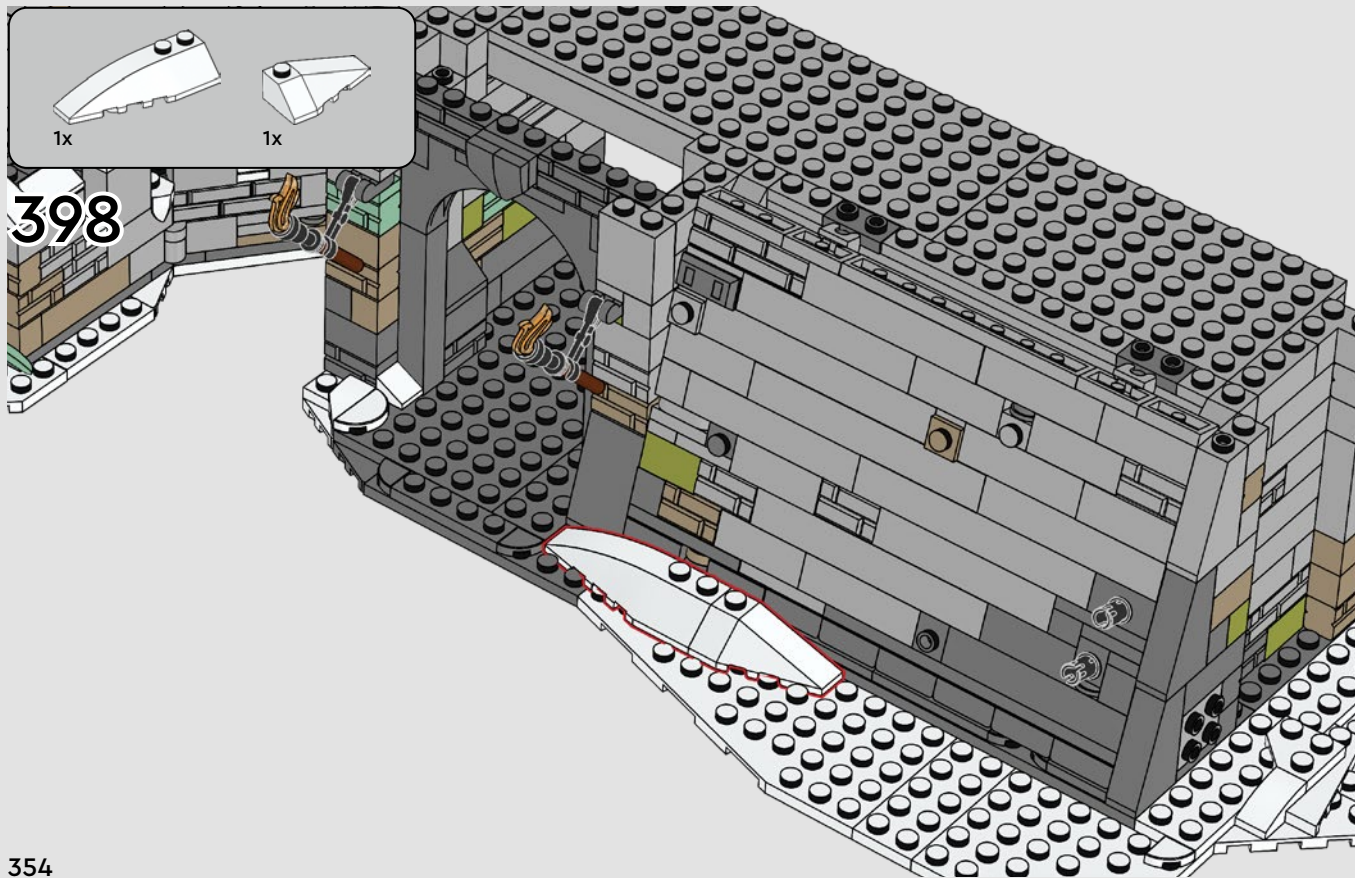

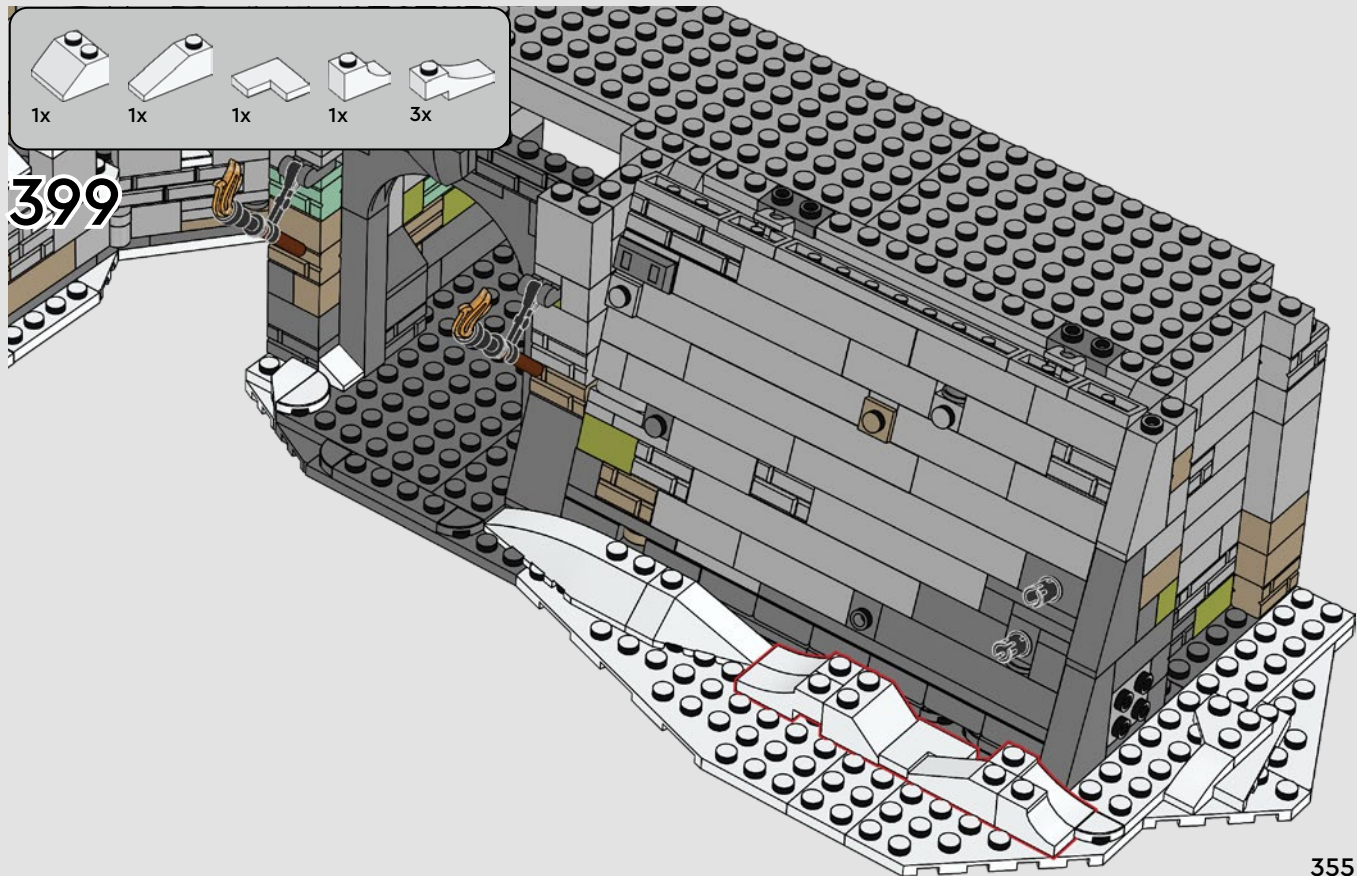

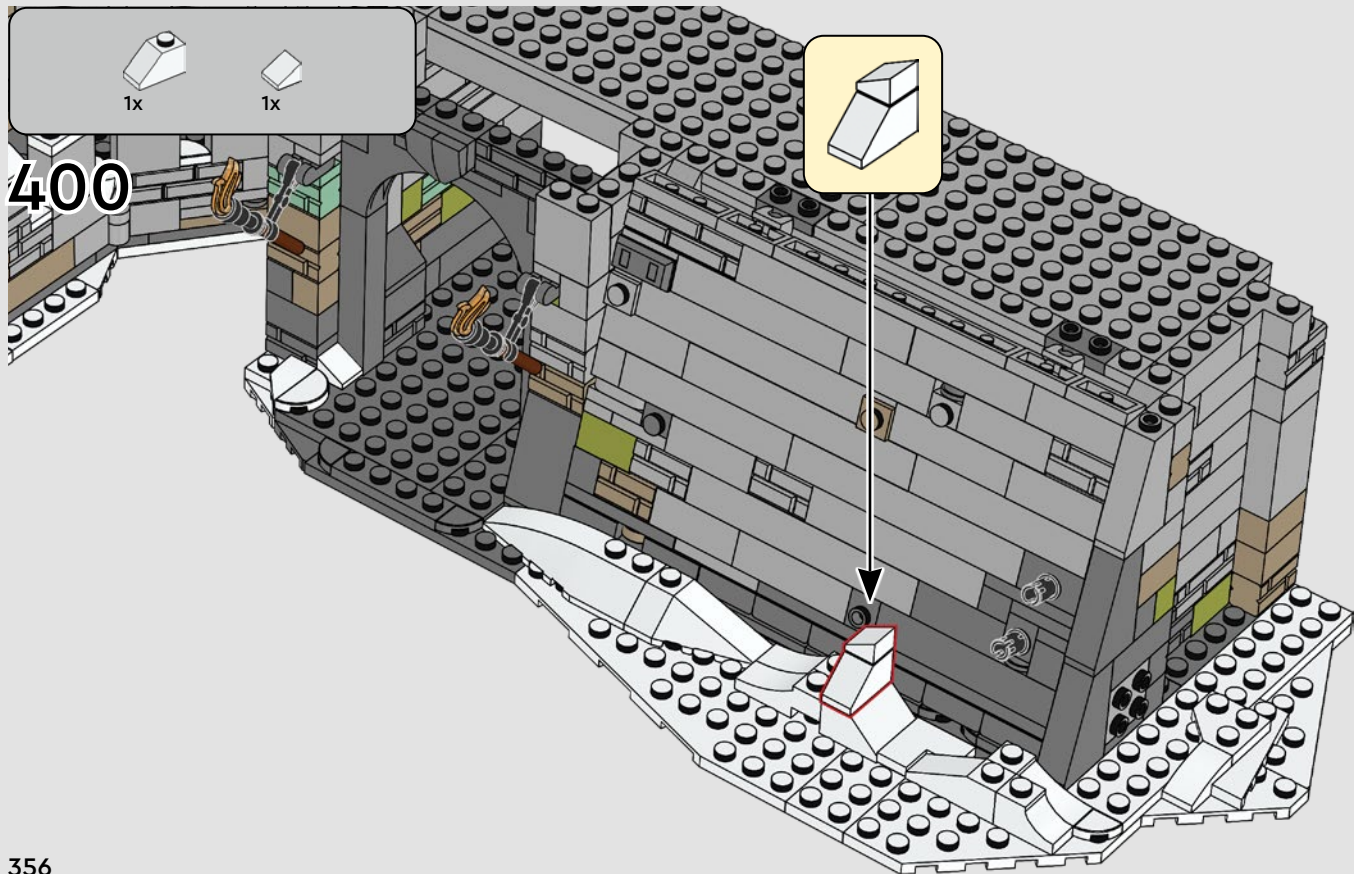

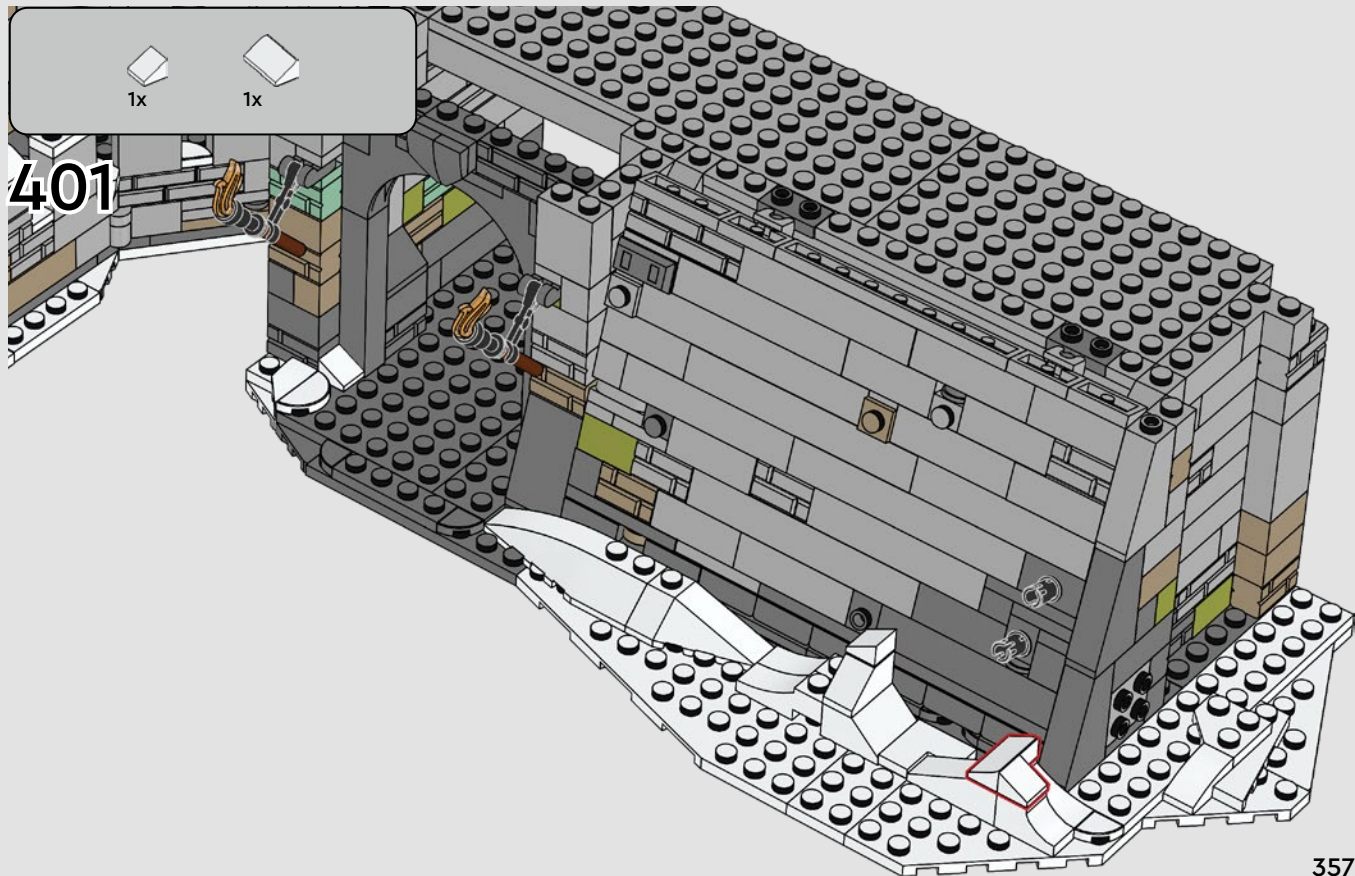

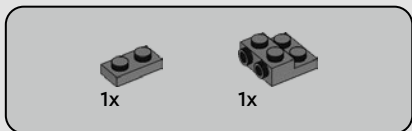
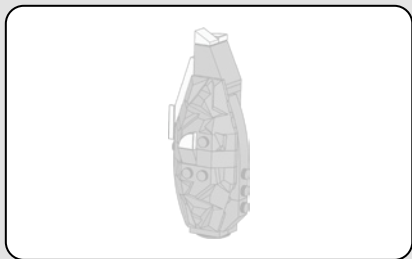

402

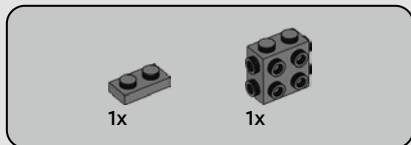
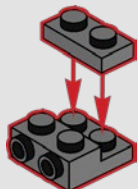

403

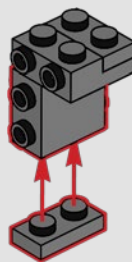

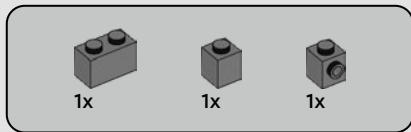

404

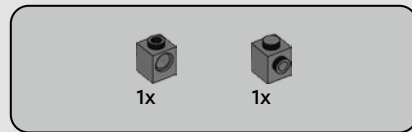
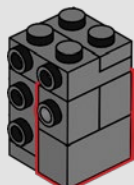

405

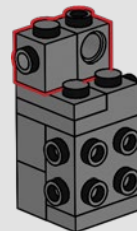



2x

406

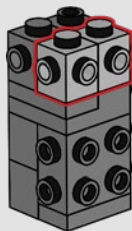

1x



1x

407

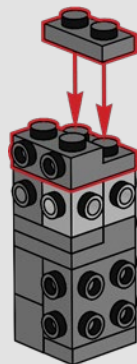



1x



2x

408

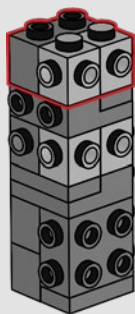

1x



1x

409

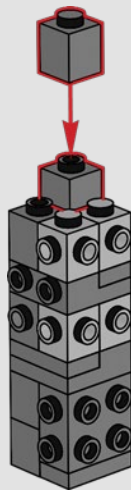

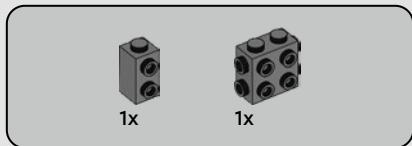

410

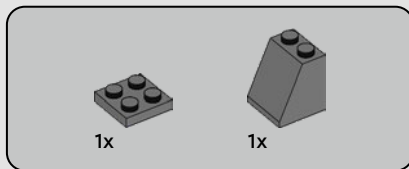
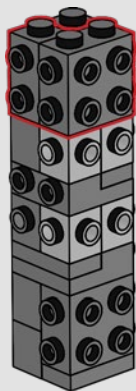

411

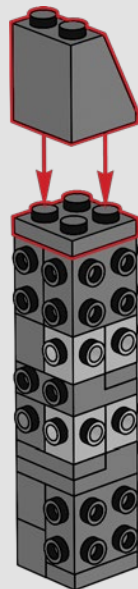



1x



1x

412

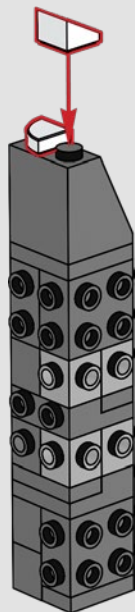

1x

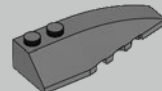

1x

413

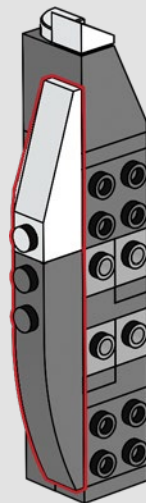

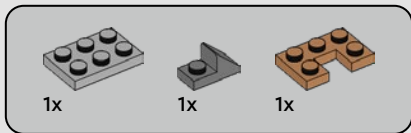

414

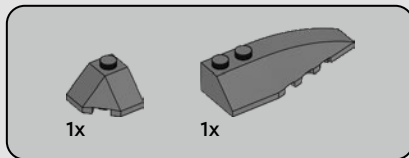
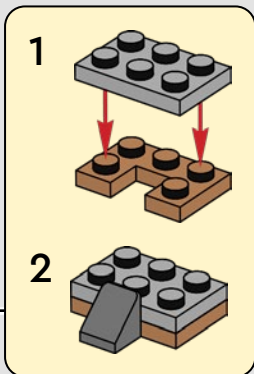
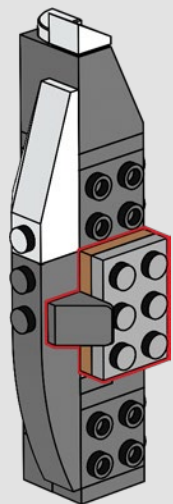

415

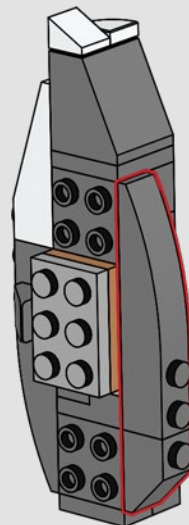



1x



1x

416

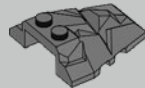
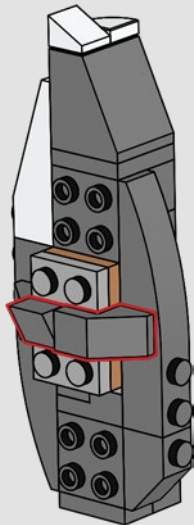

2x

417

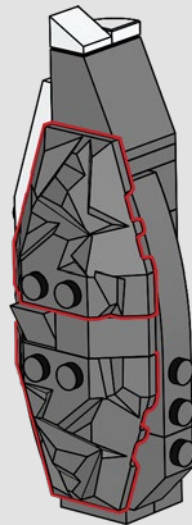

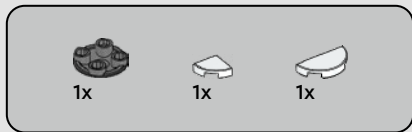

418

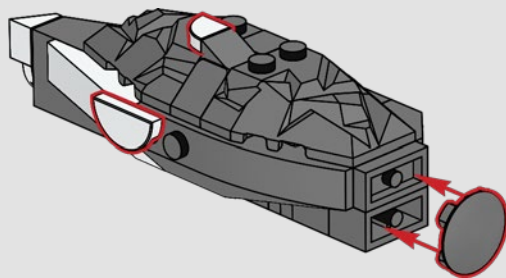

419

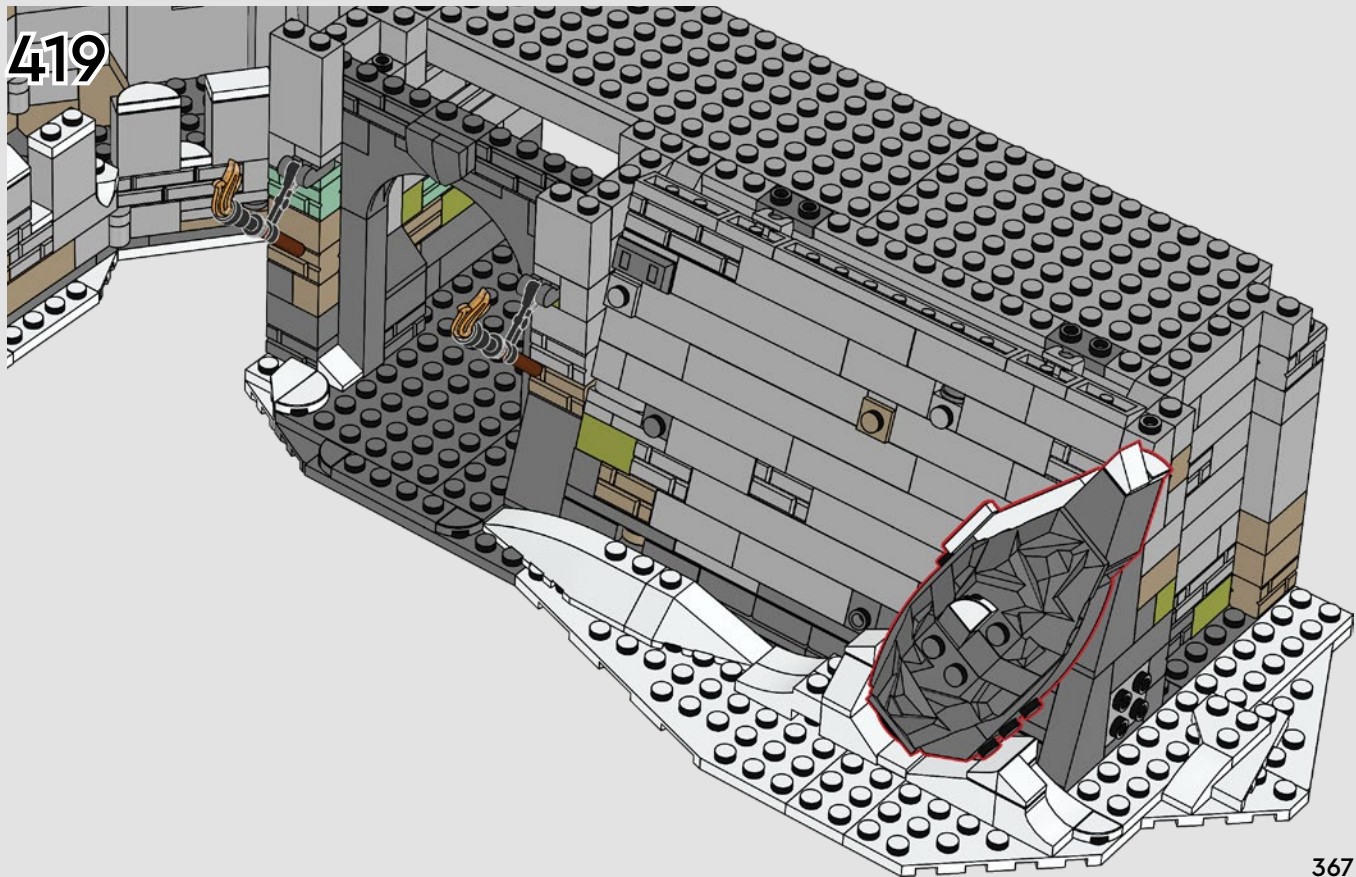

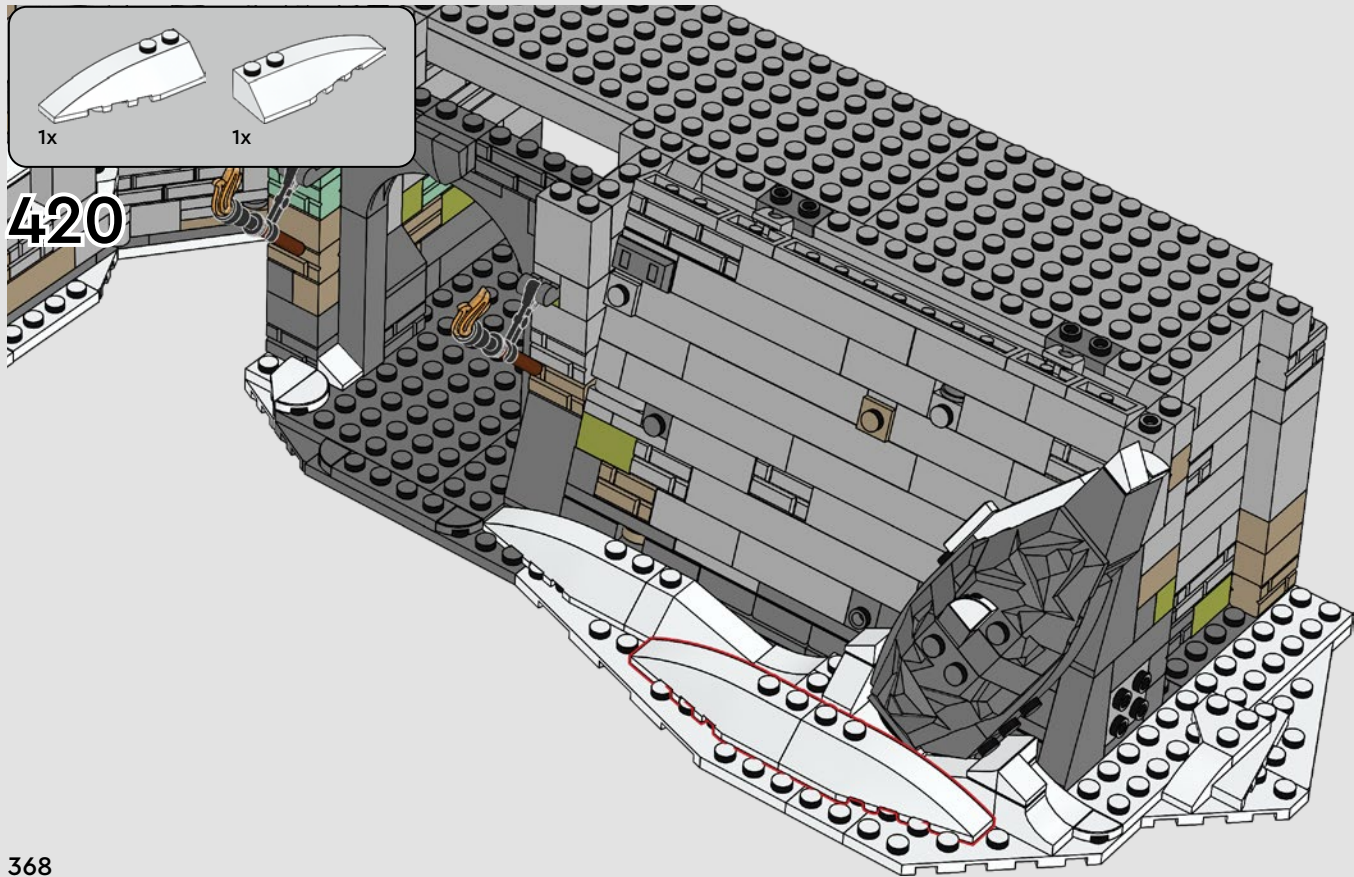

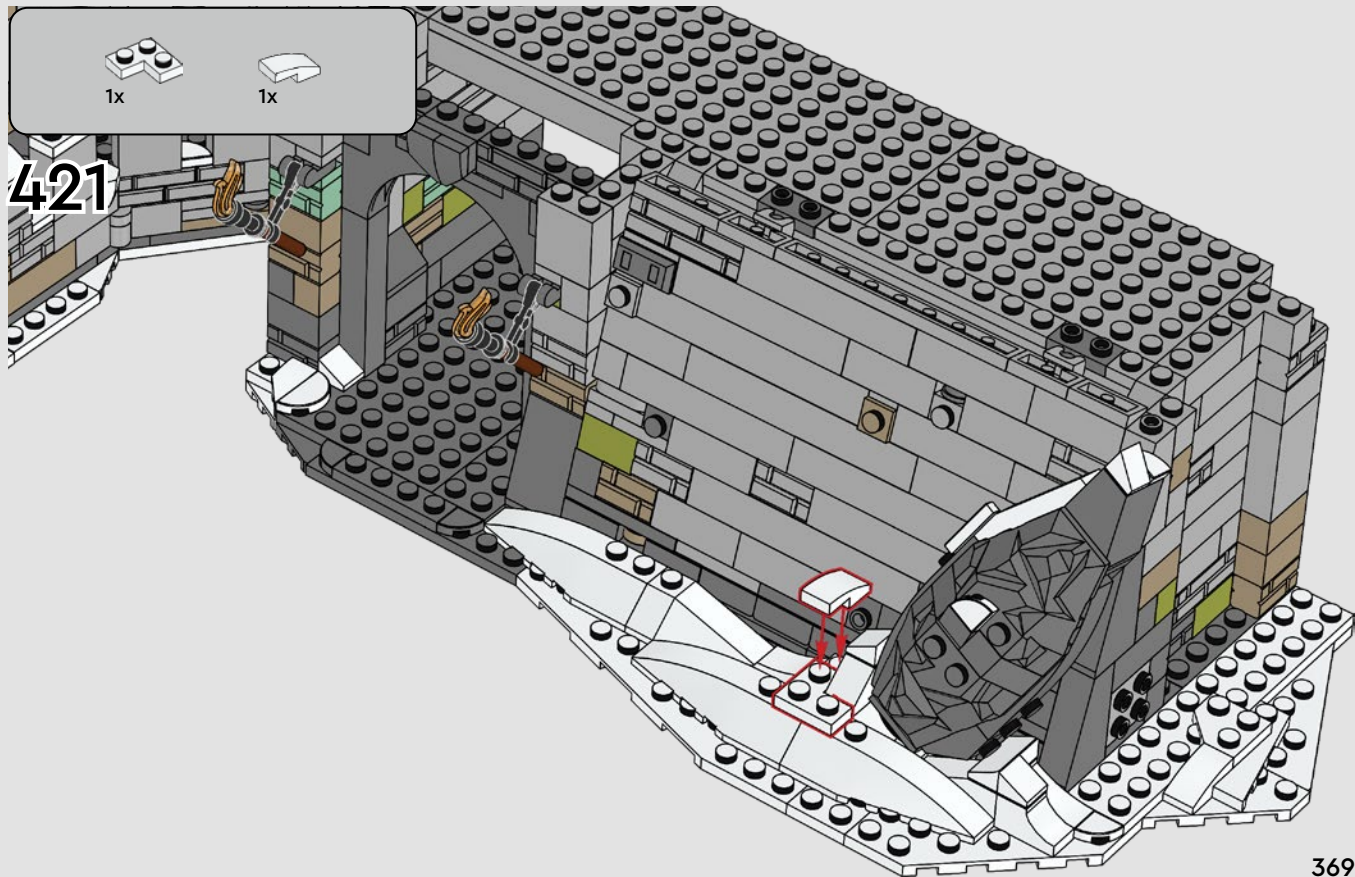

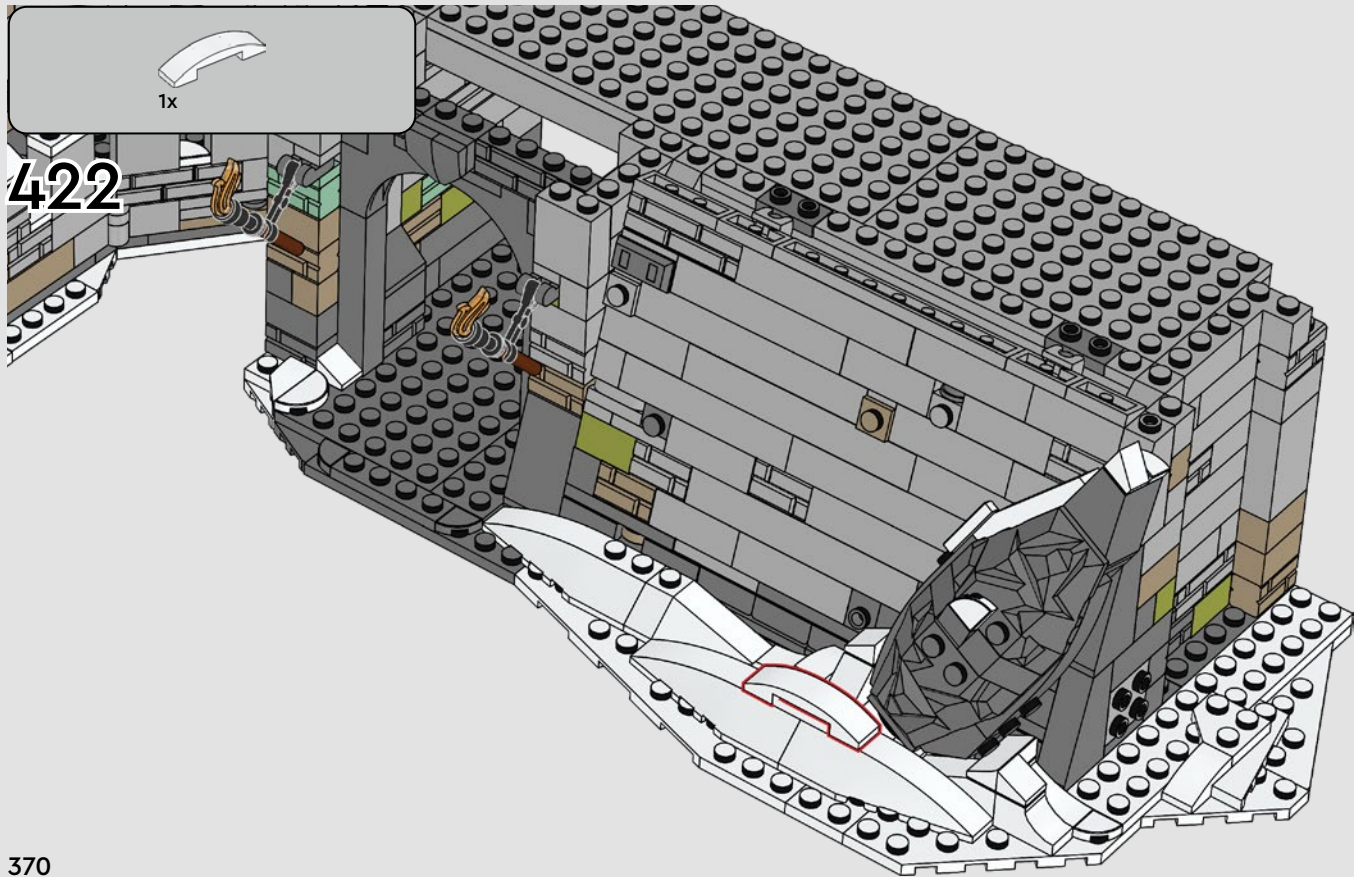

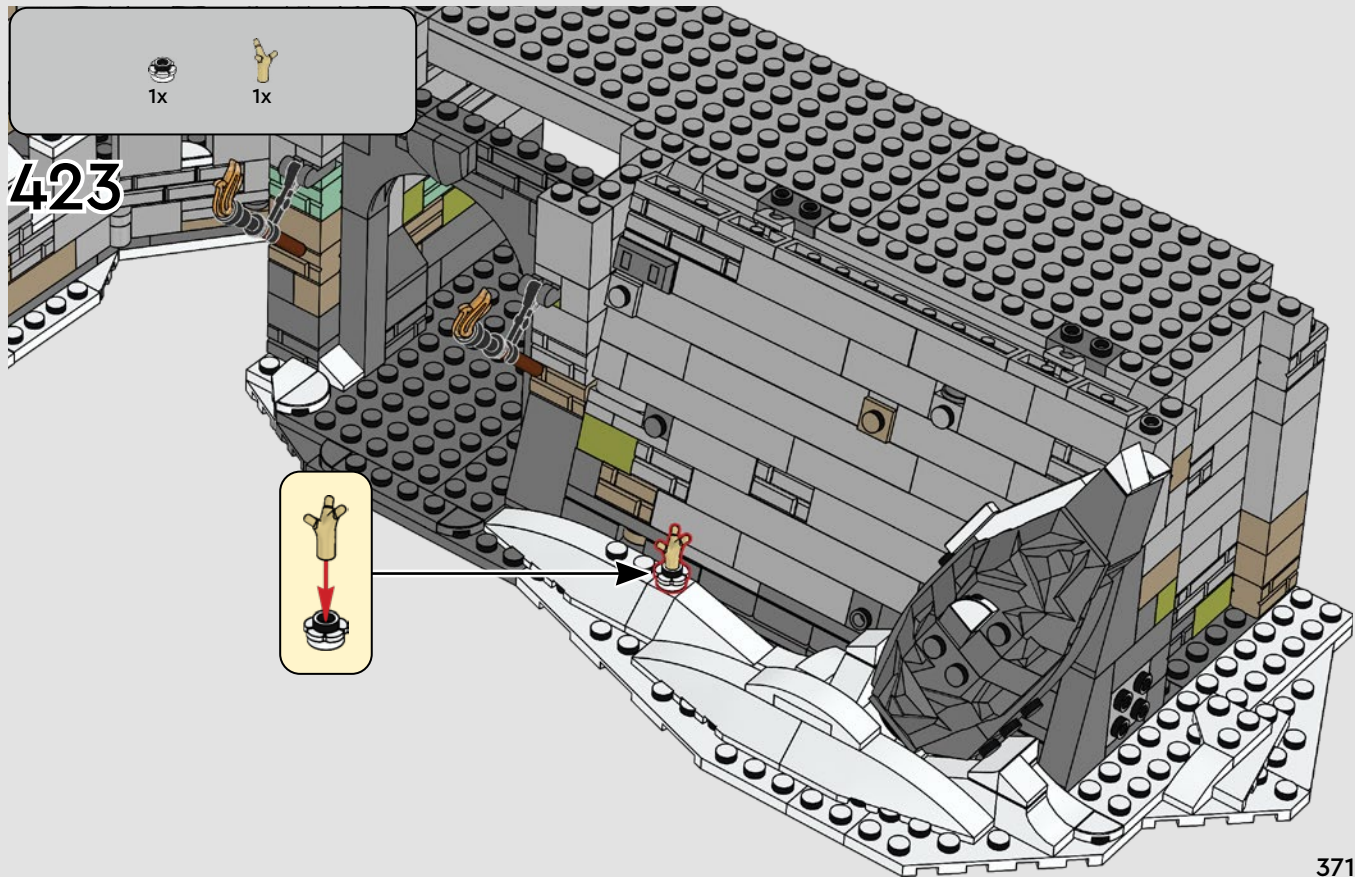

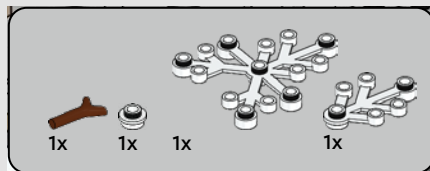

424

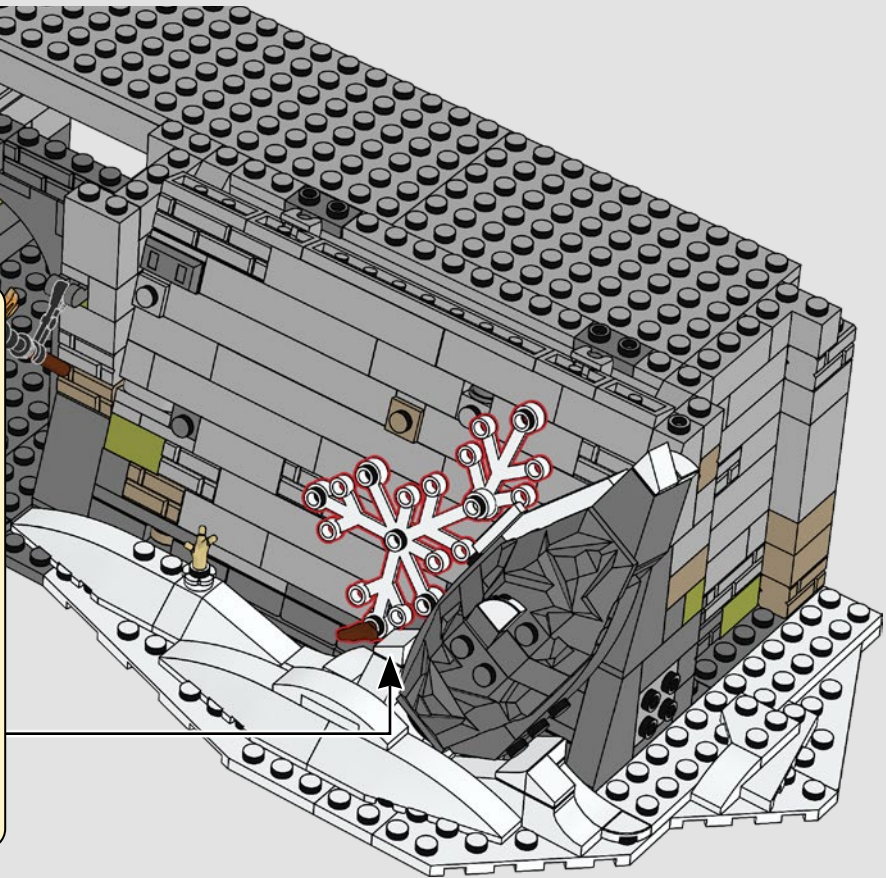
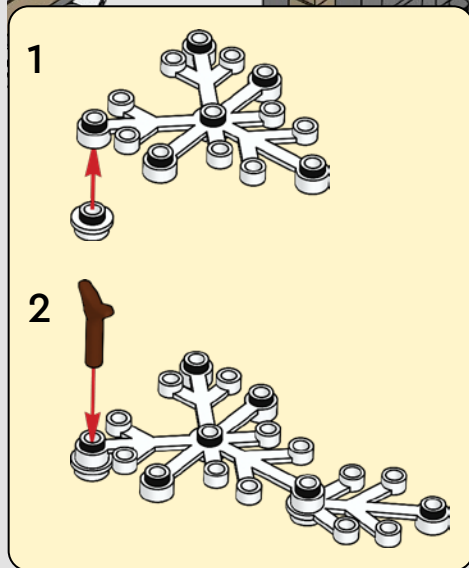

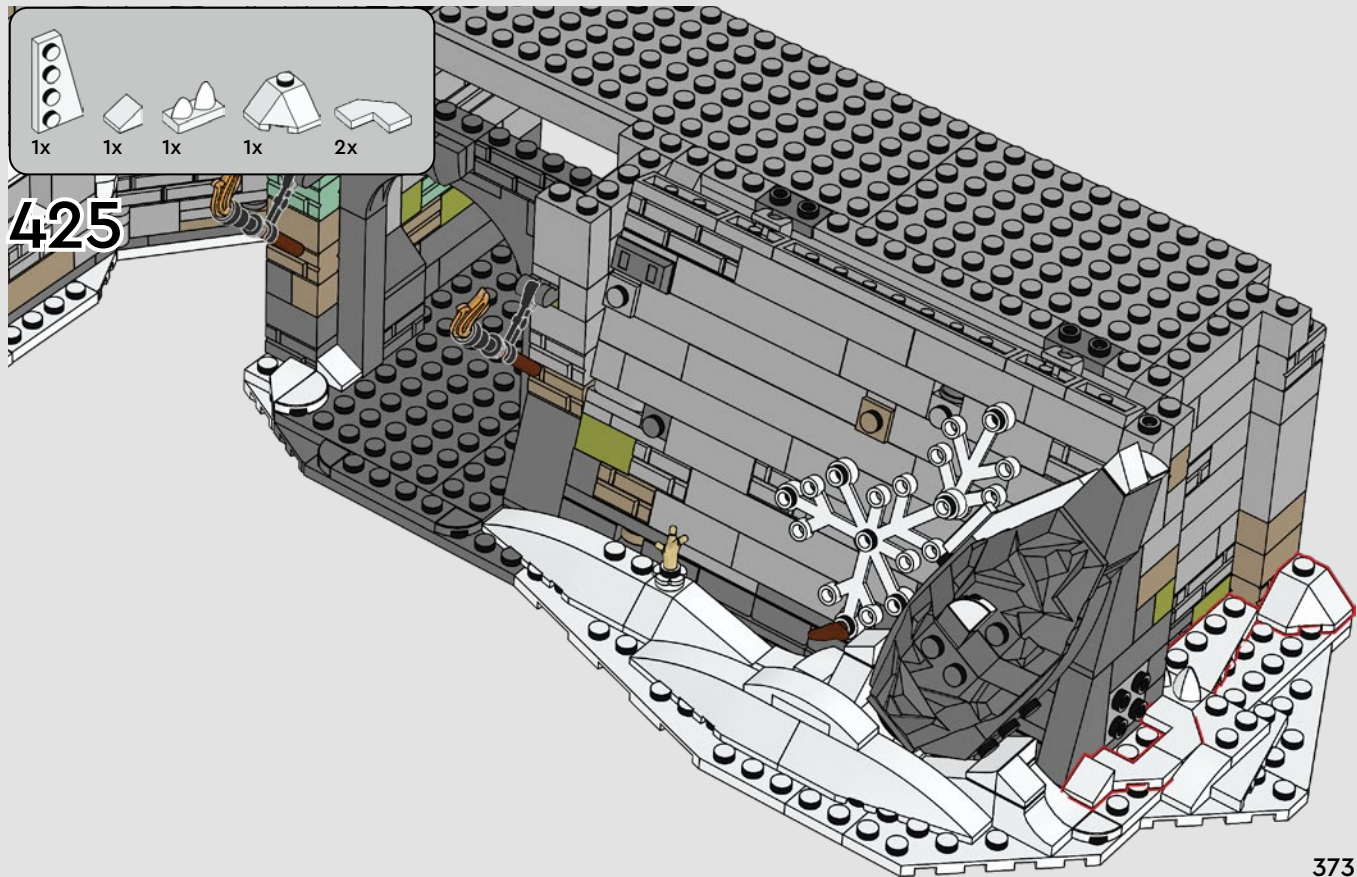

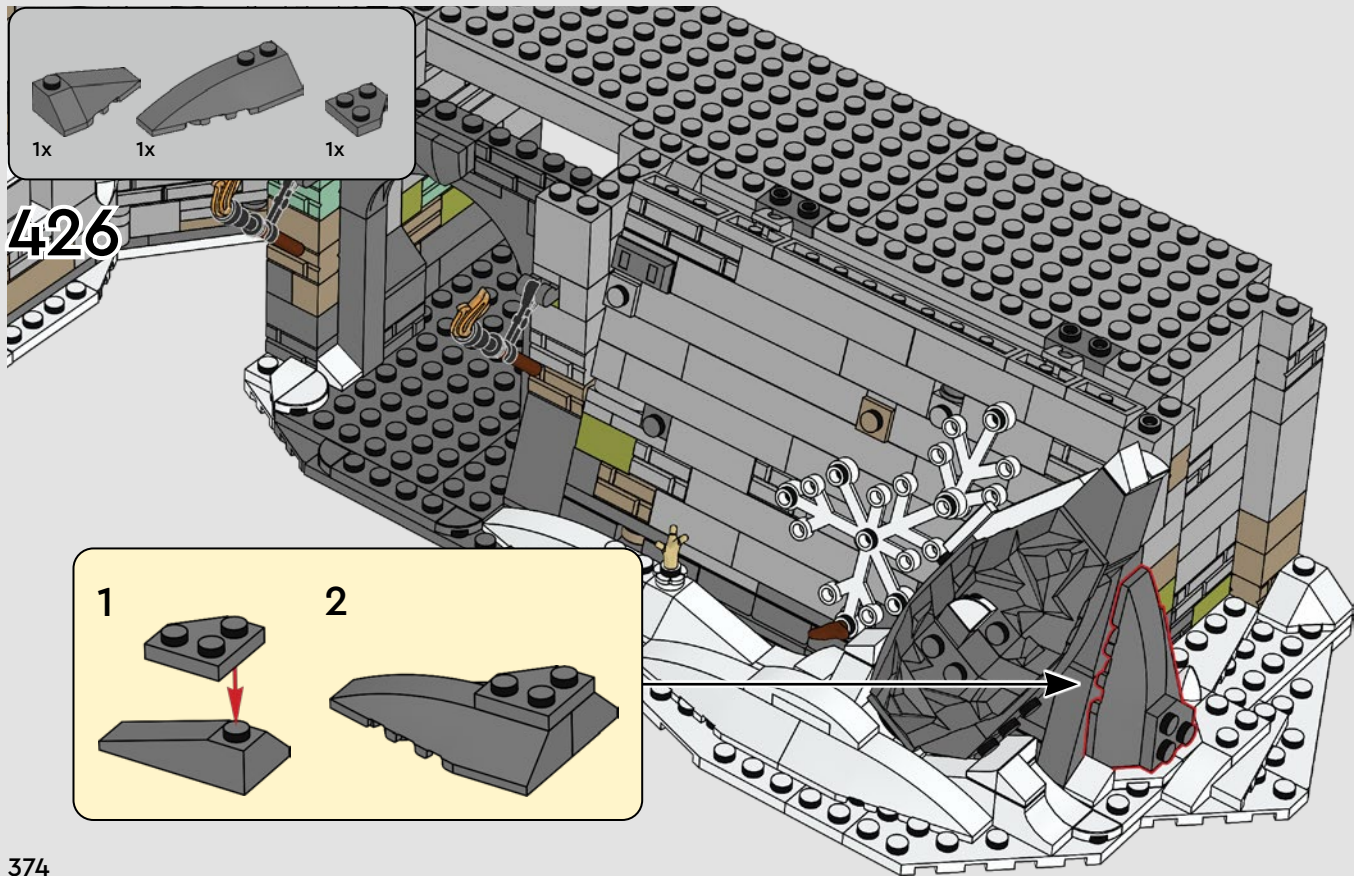

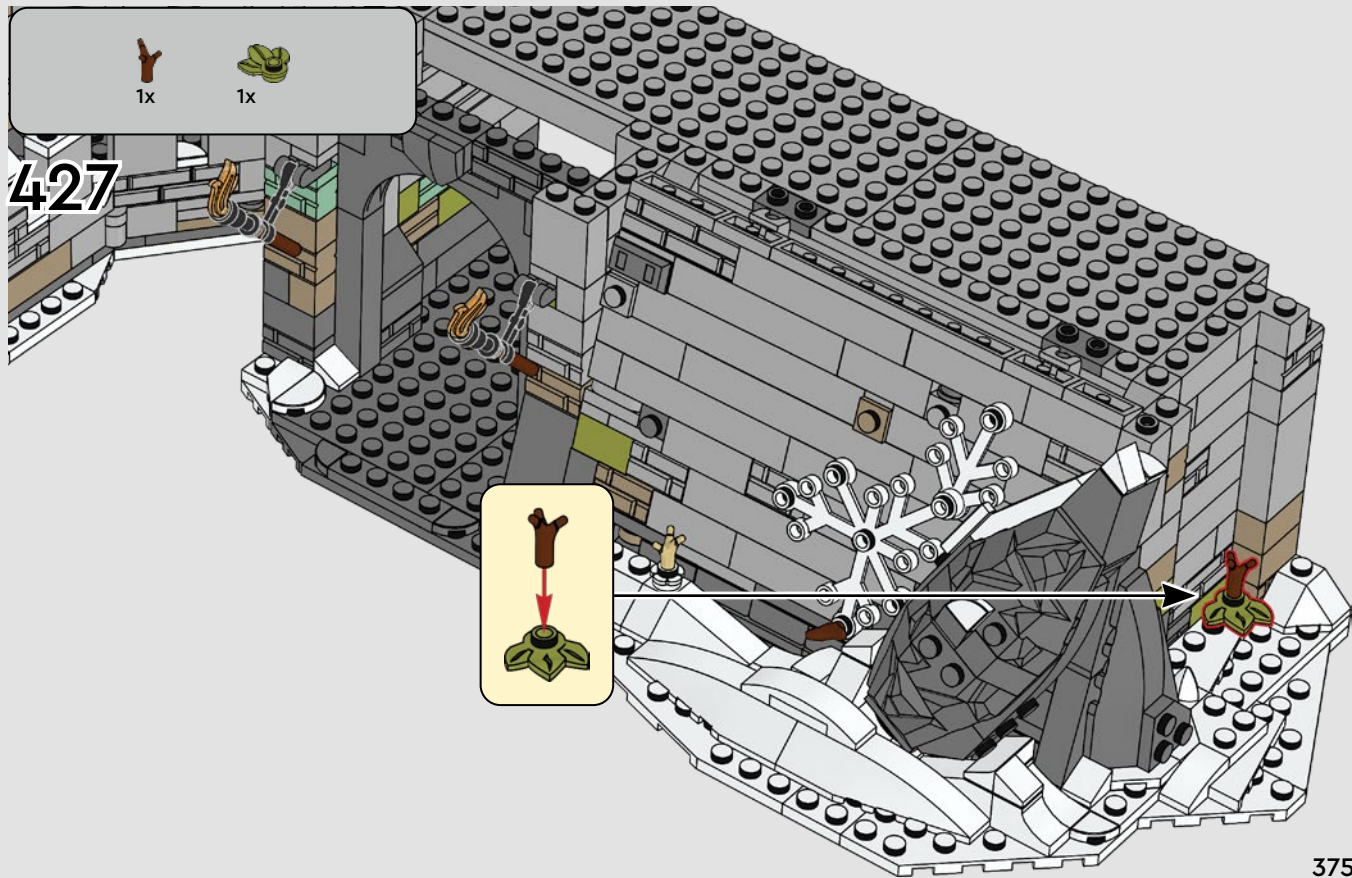



1x



1x

428

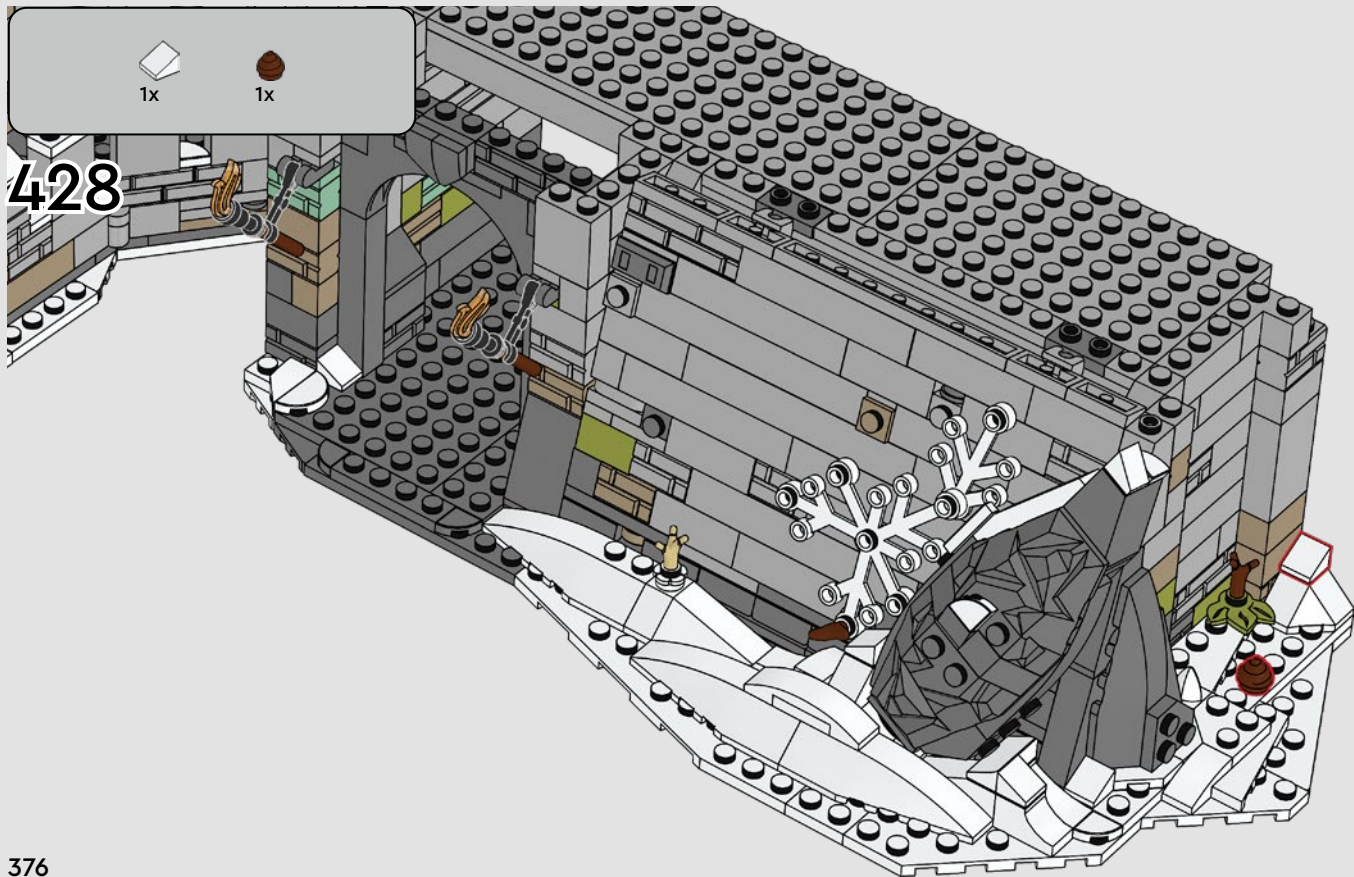

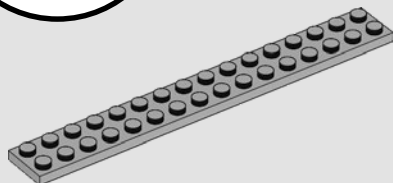
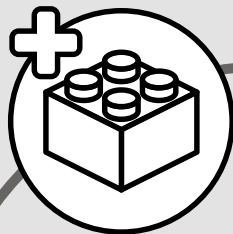

1x

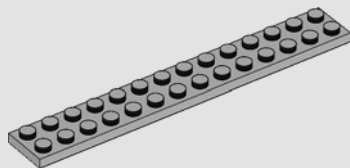

1x

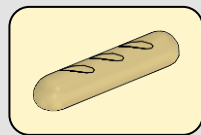
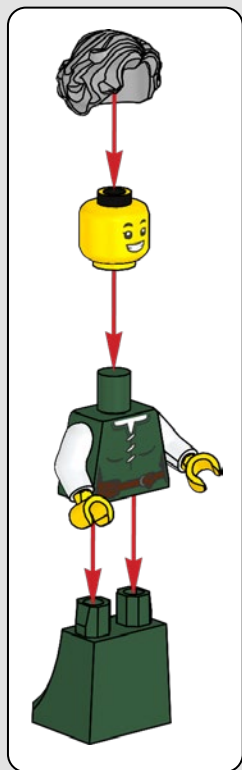

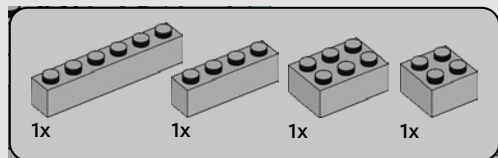

429



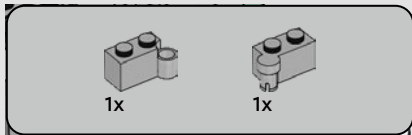

430

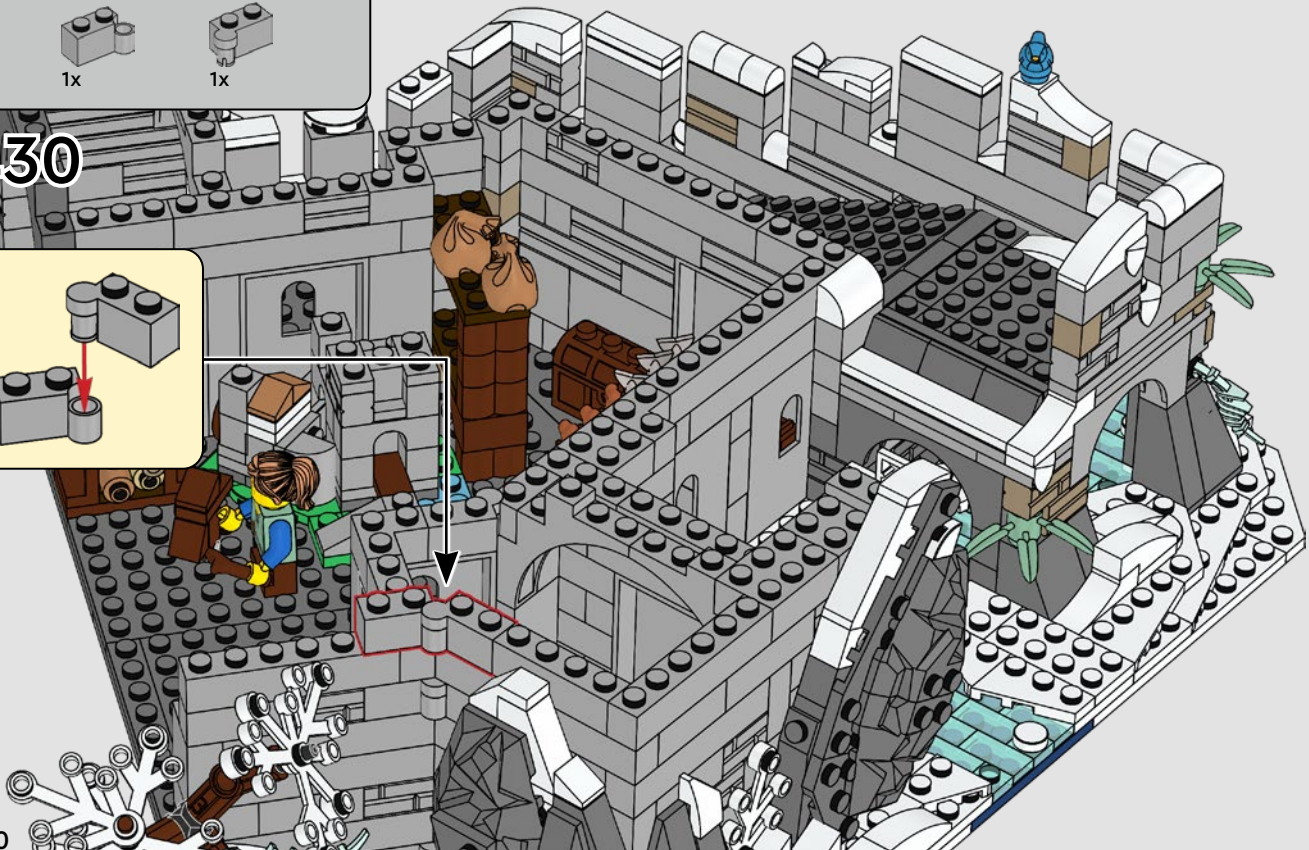
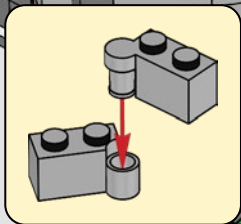

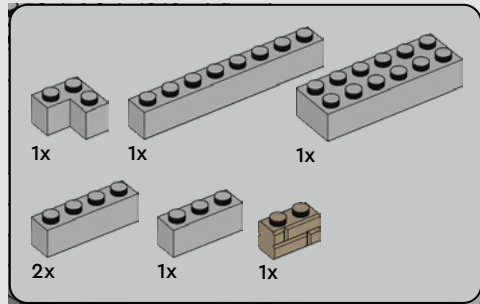

431

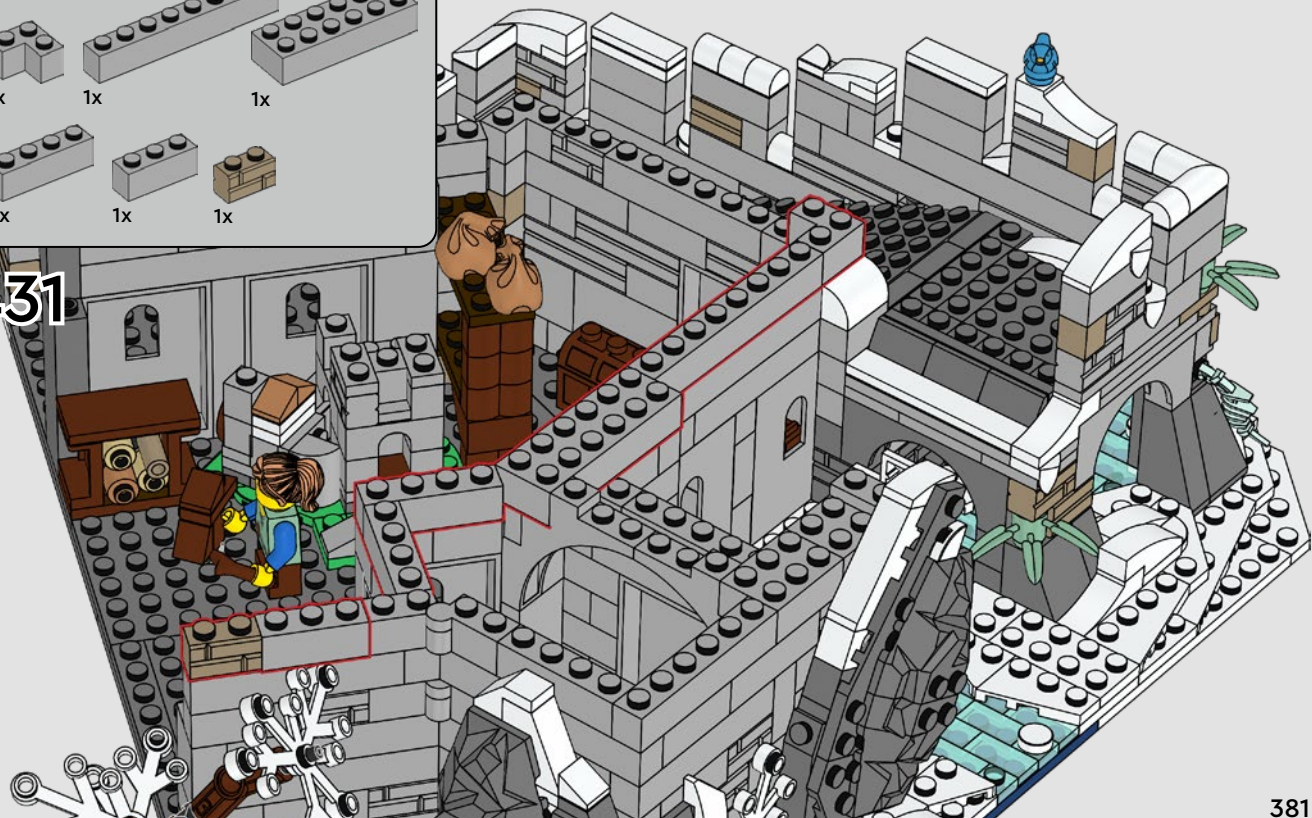

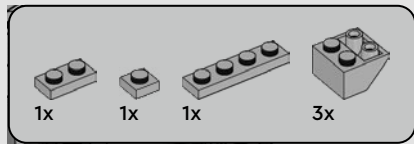

432



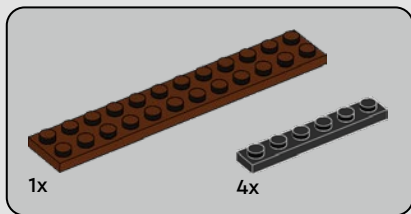
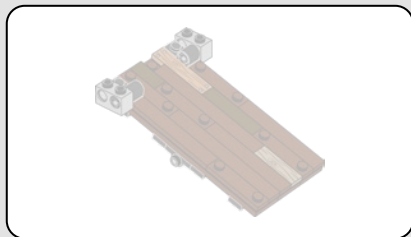

433

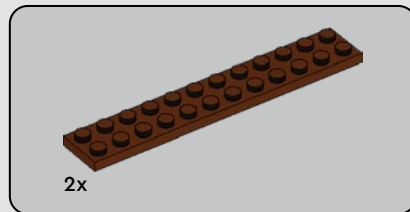
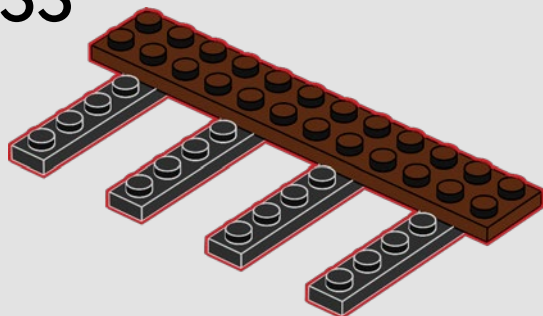

434

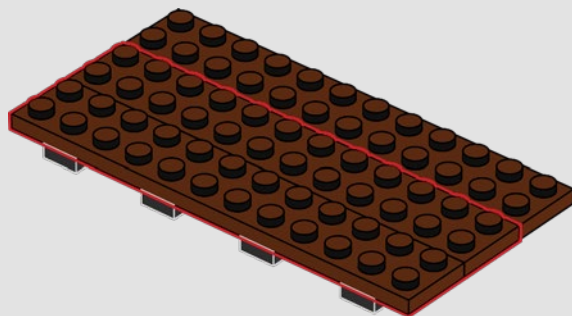

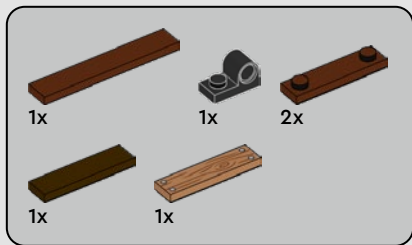

435

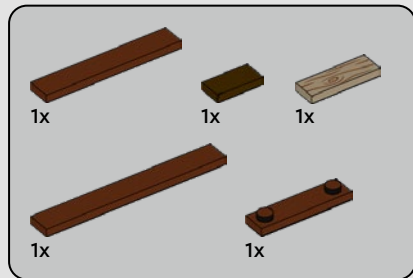
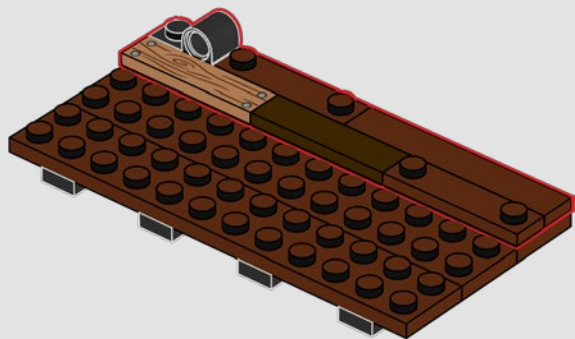

436

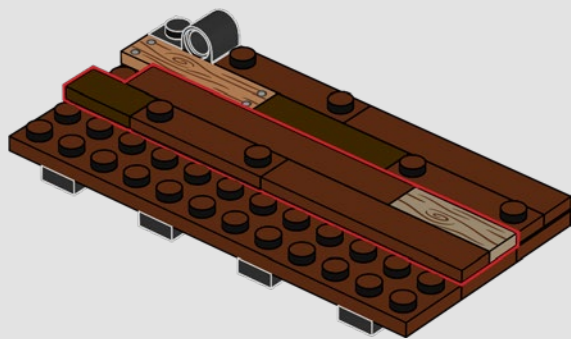

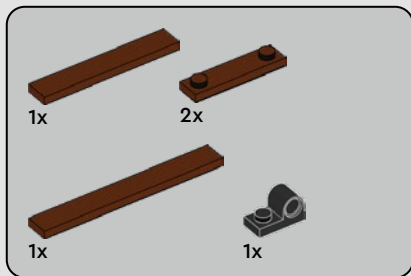

437

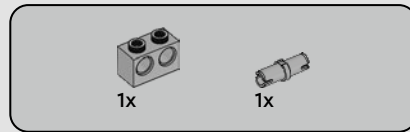
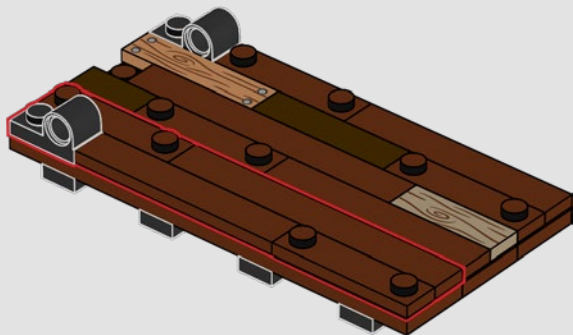

438

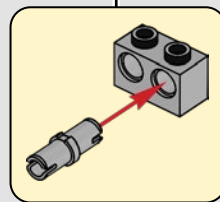
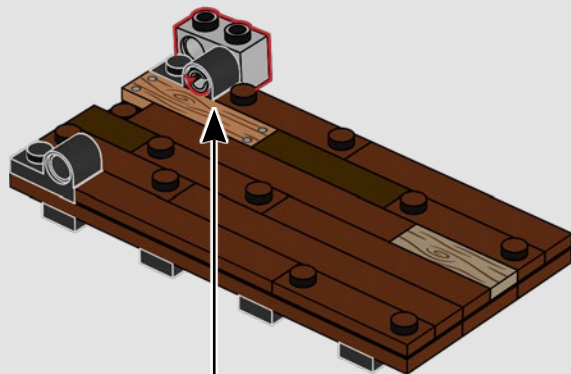

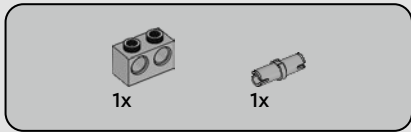

439

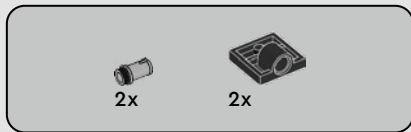
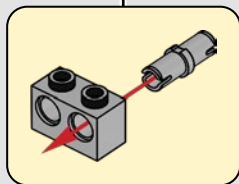
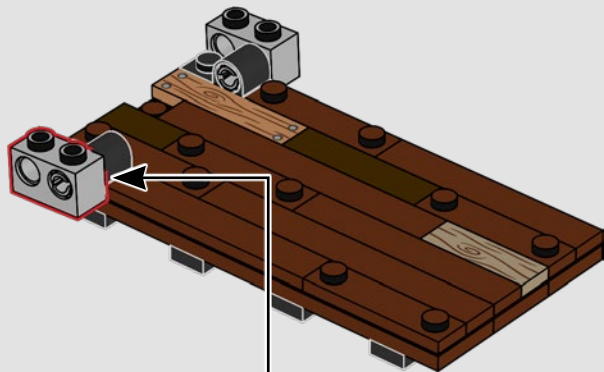

440

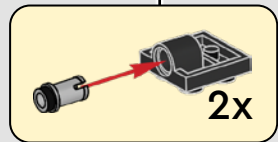
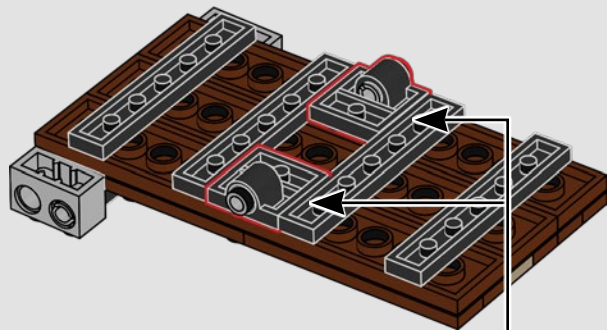

441

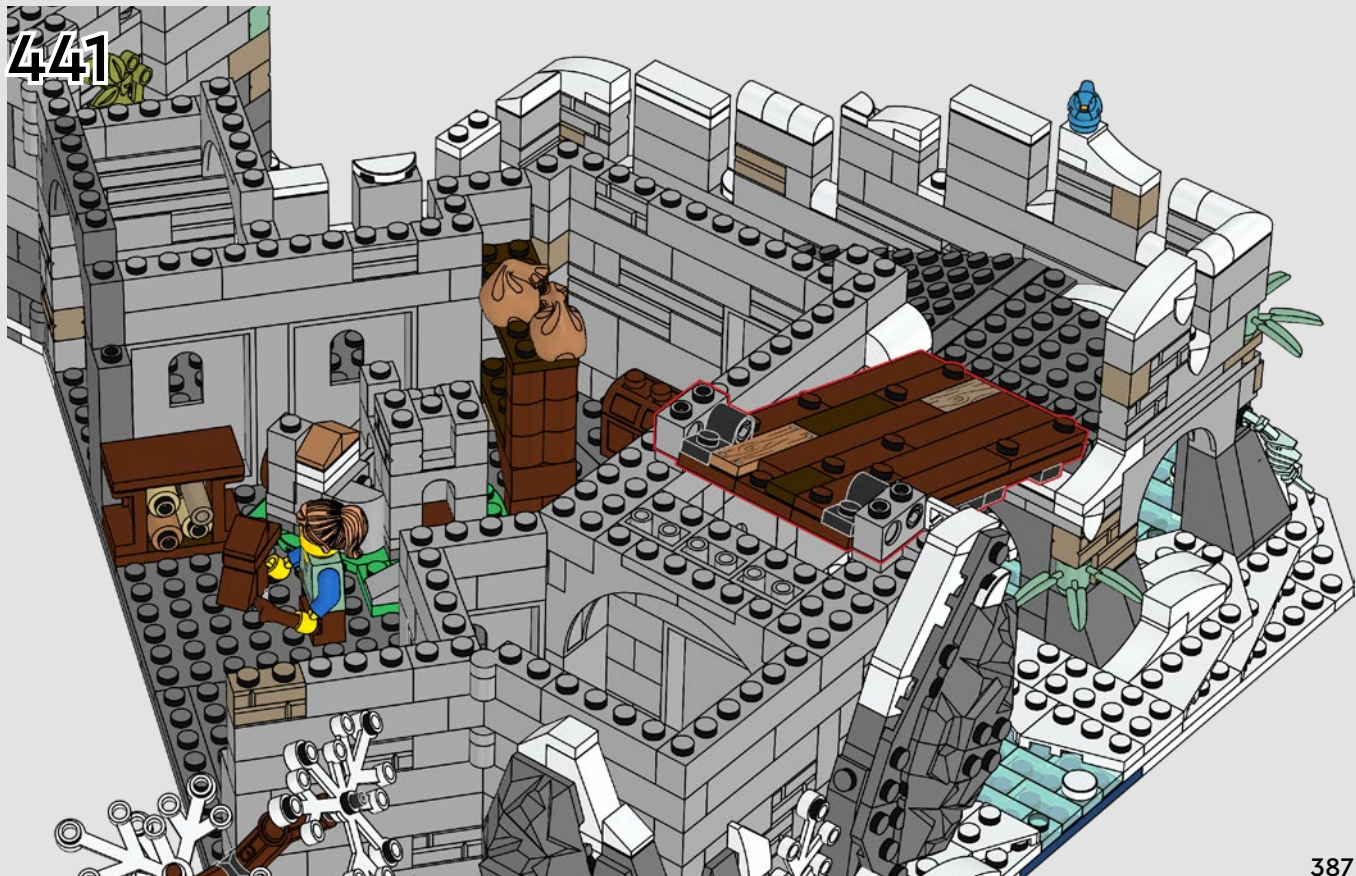

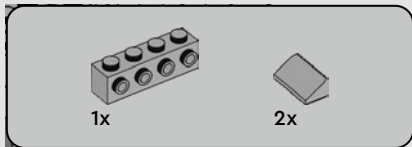

442

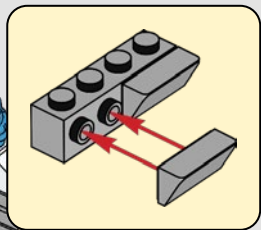

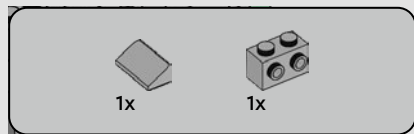

443

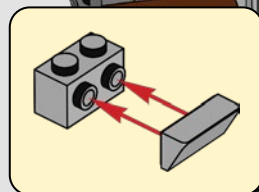

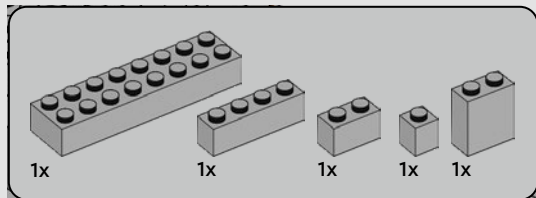

444

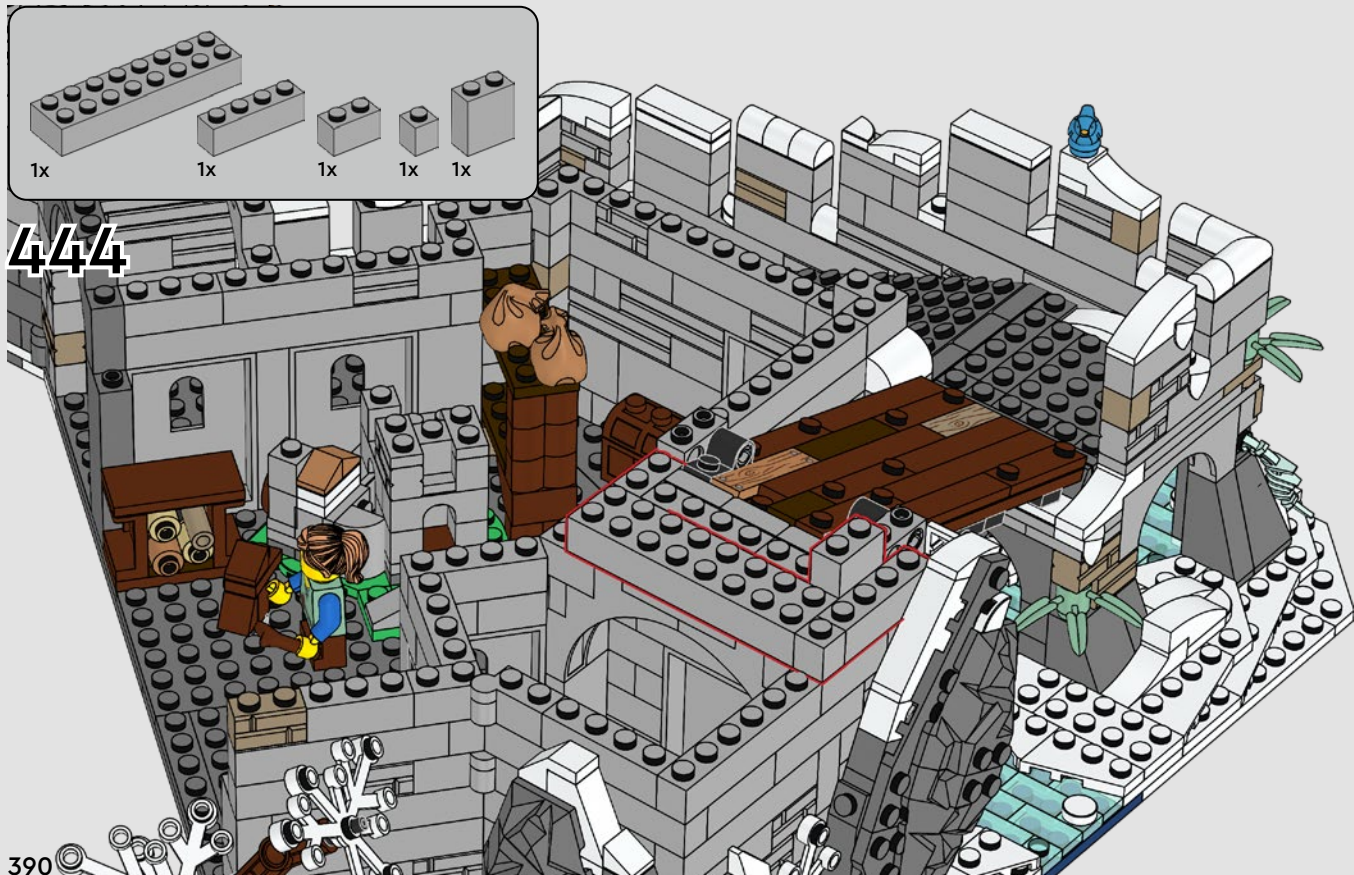



2x



1x

445

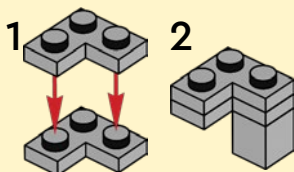

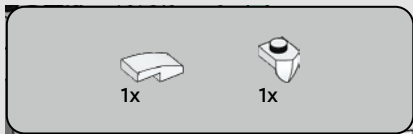

446

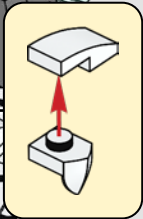

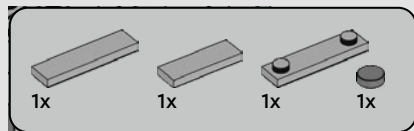

447

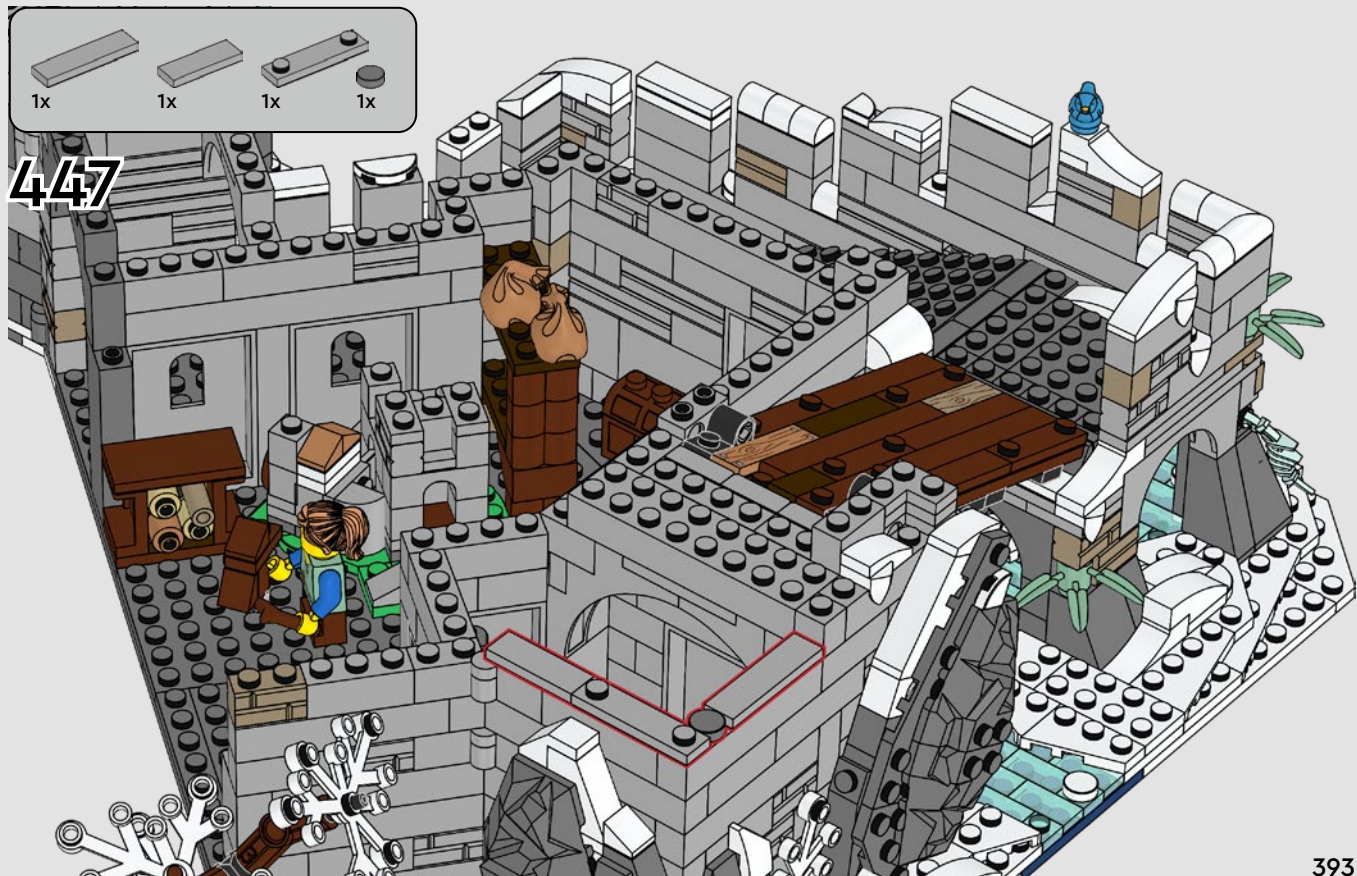

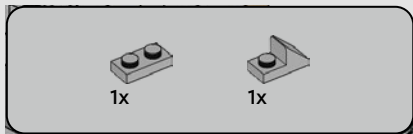

448



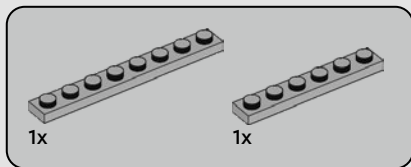

449

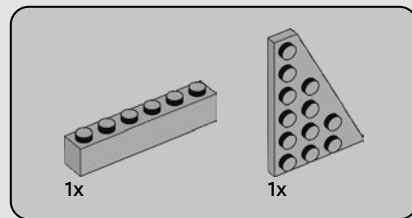
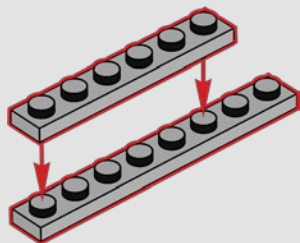

450

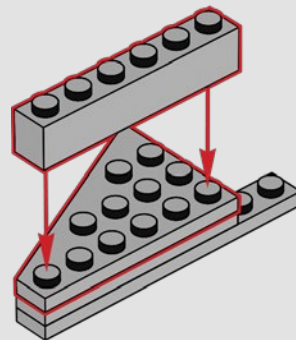

453



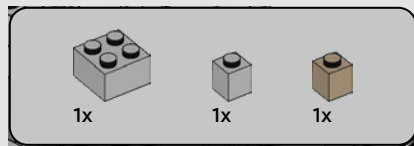

454





1x



1x



1x

455



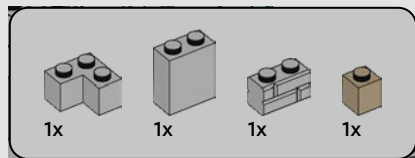

456





2x



2x

457



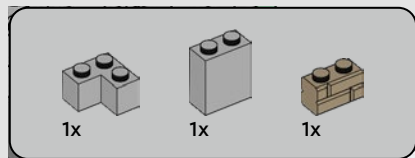

458





459



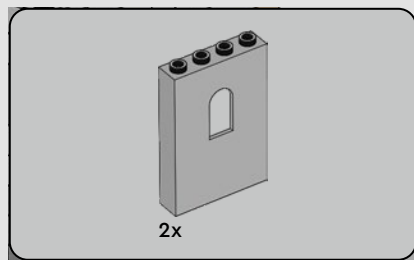

460



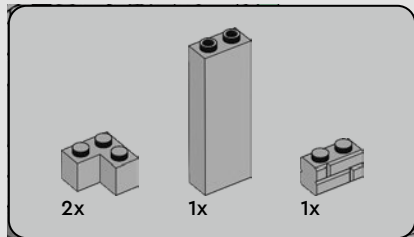

461



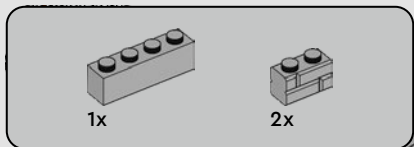

462



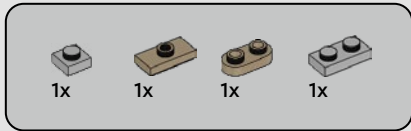

463





1x



1x

464

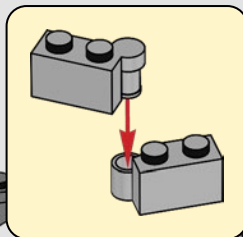

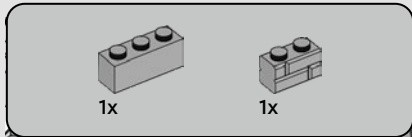

465



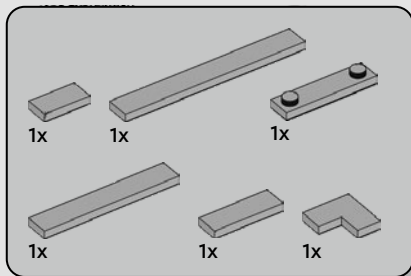

466

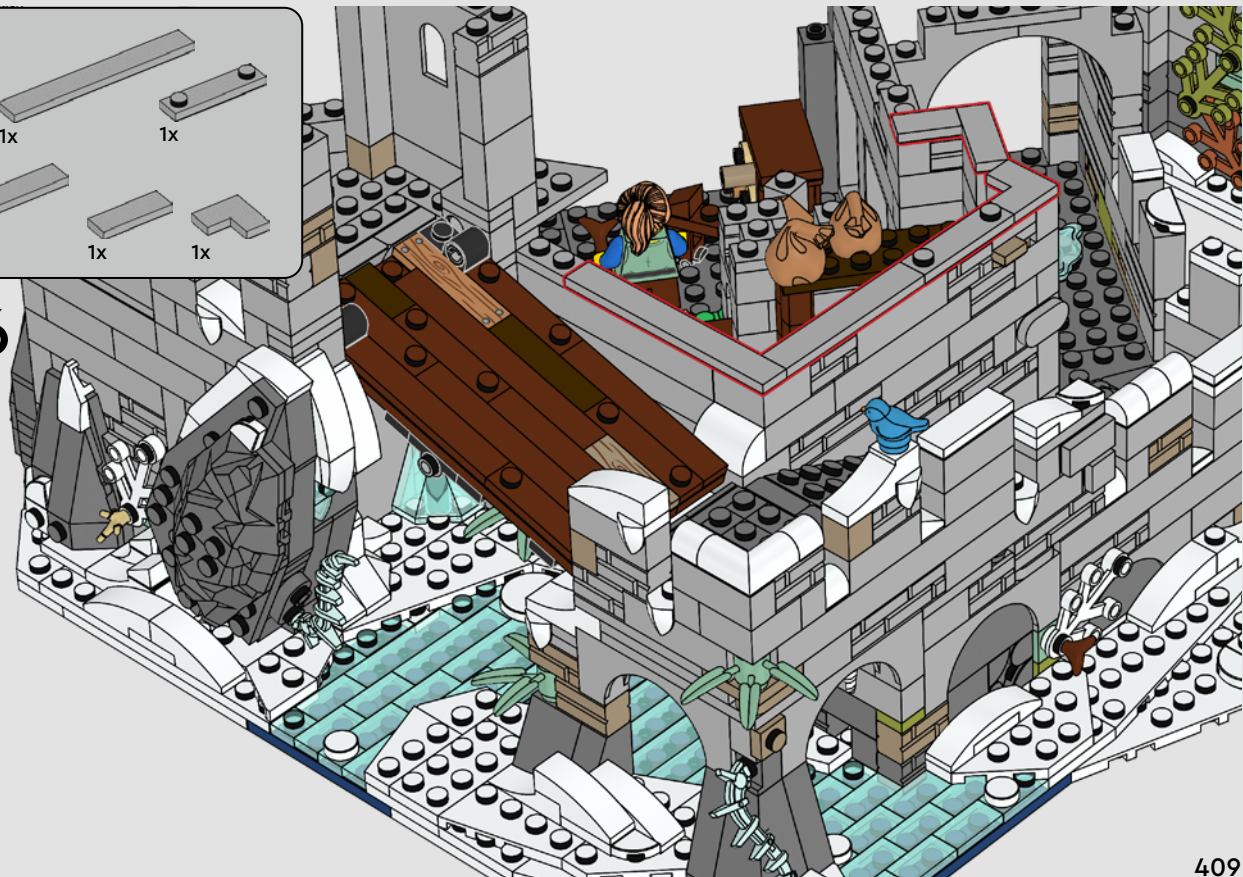

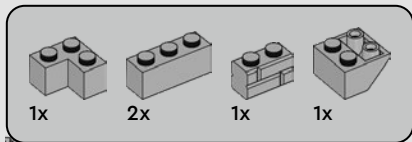

467



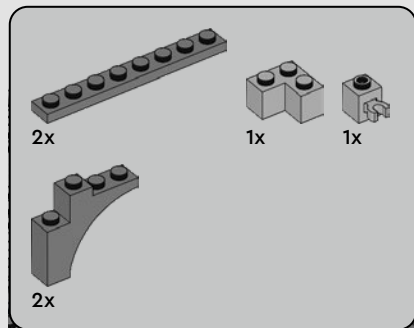

468



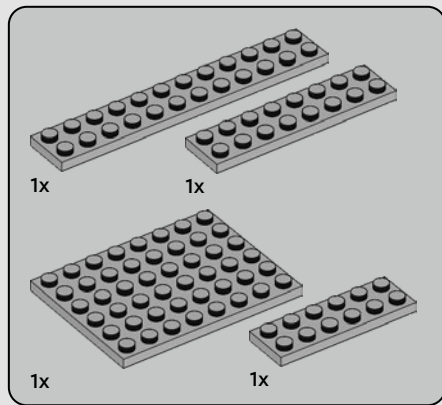
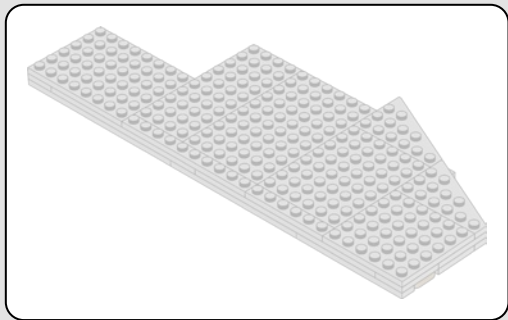

469

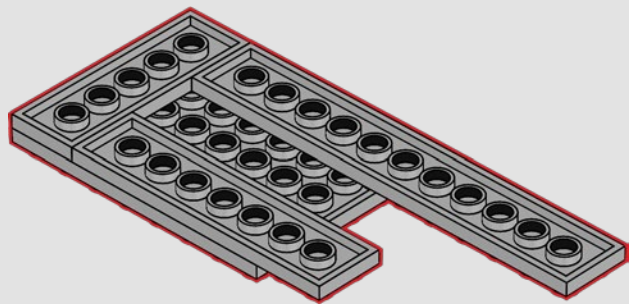

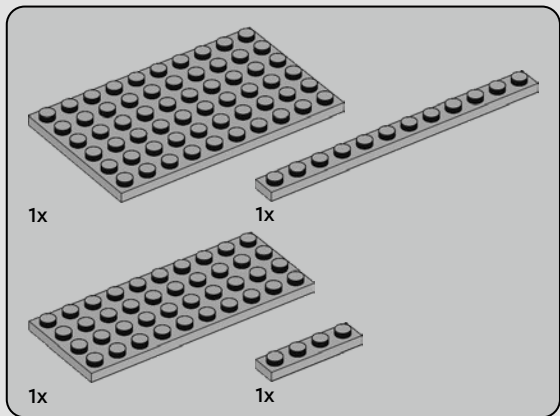

470

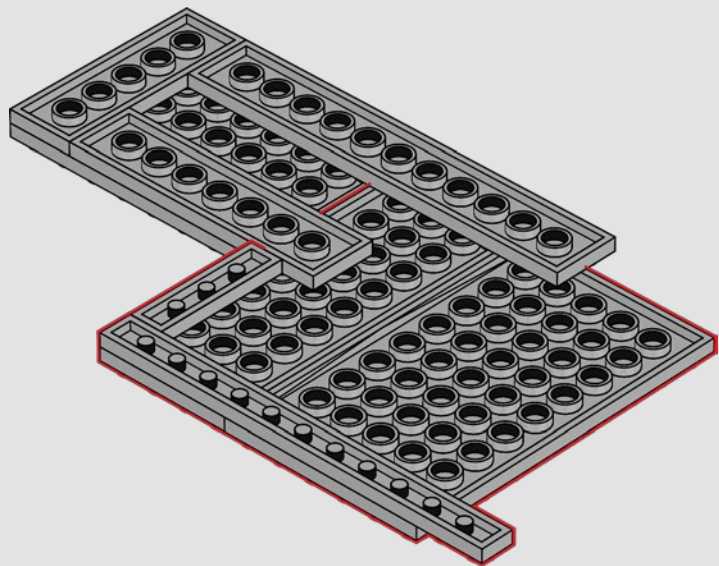

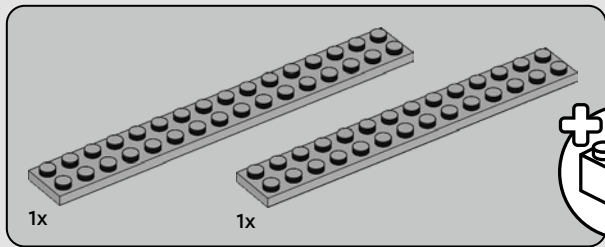

471

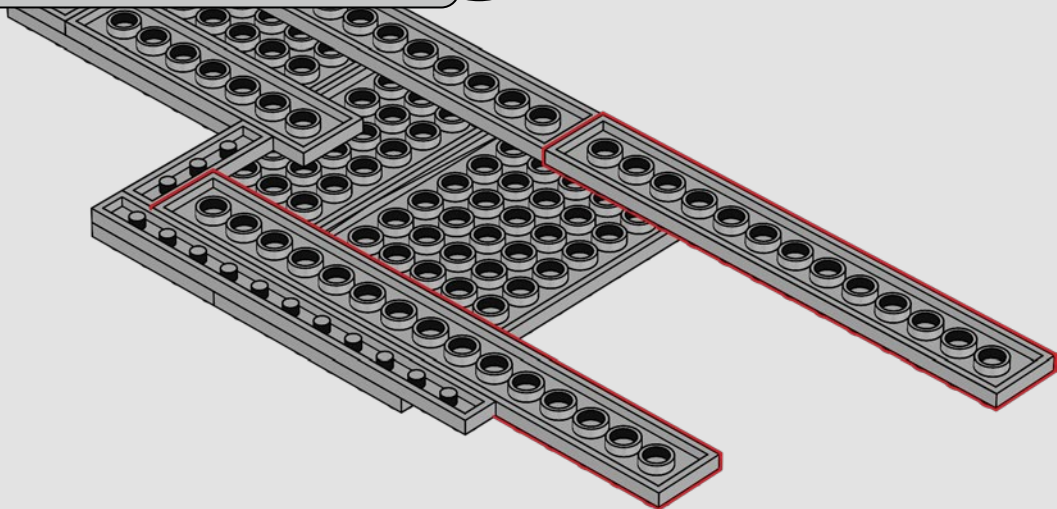

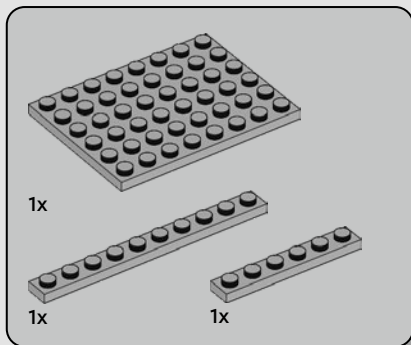

472

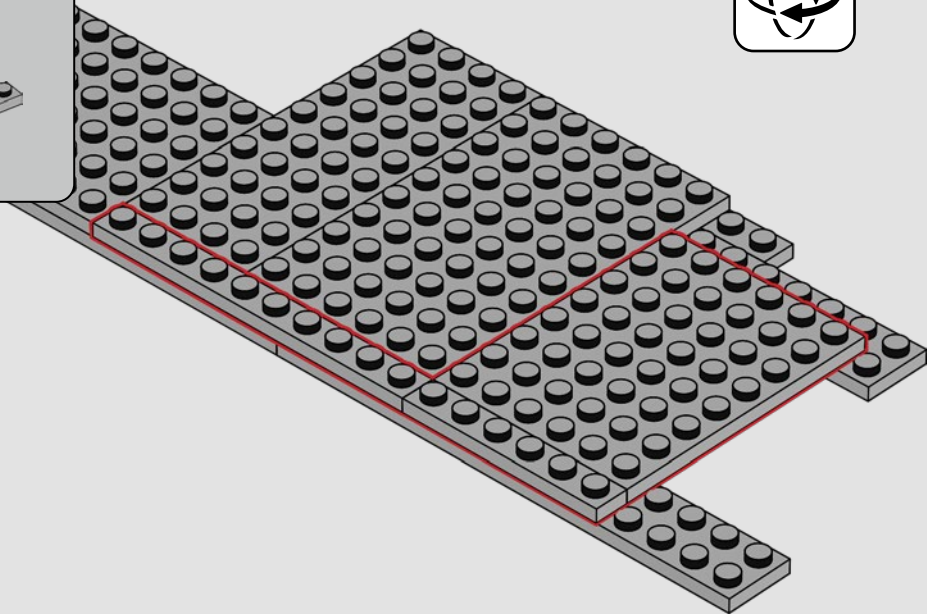

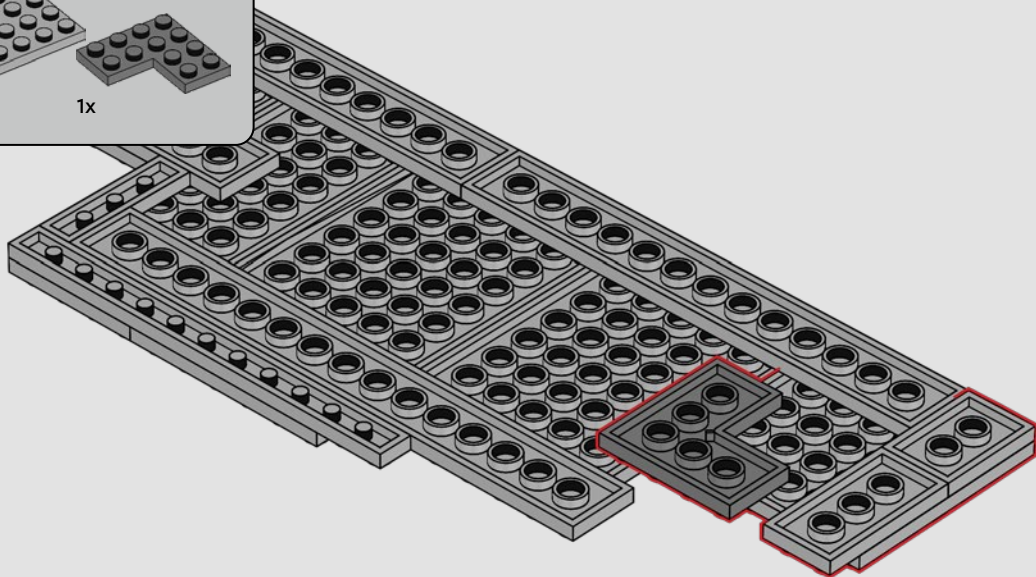
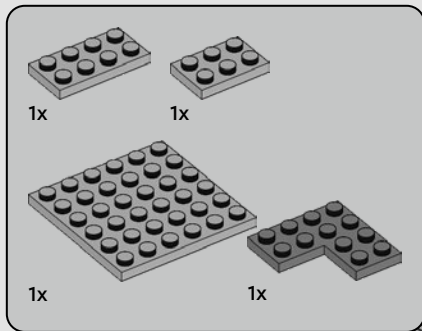

473

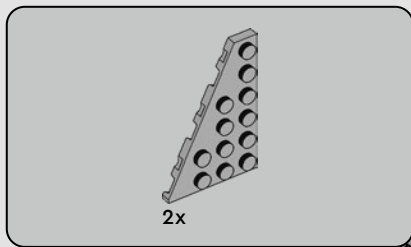

474

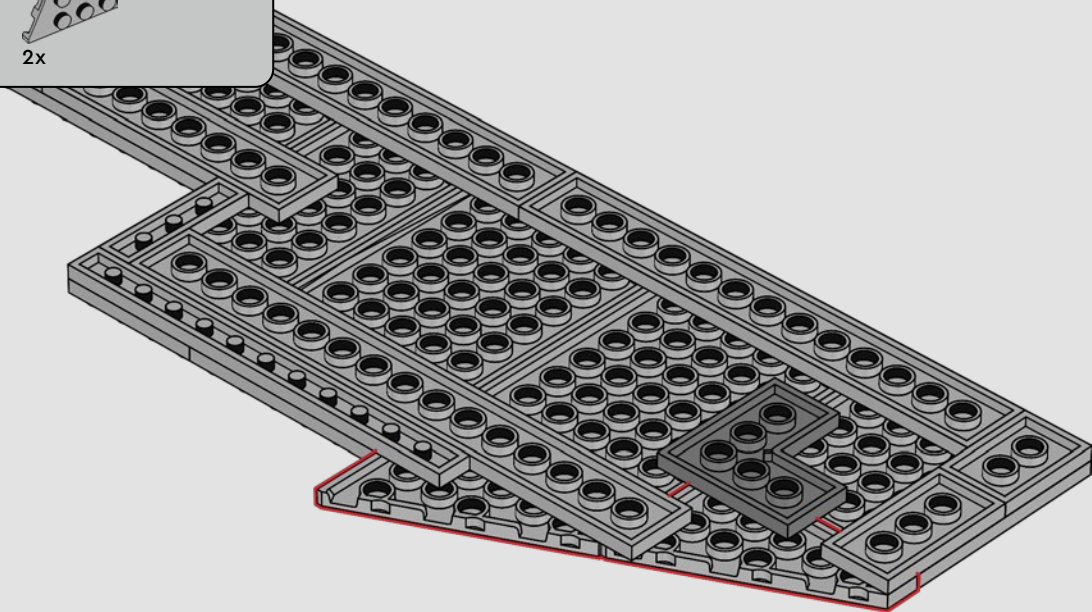

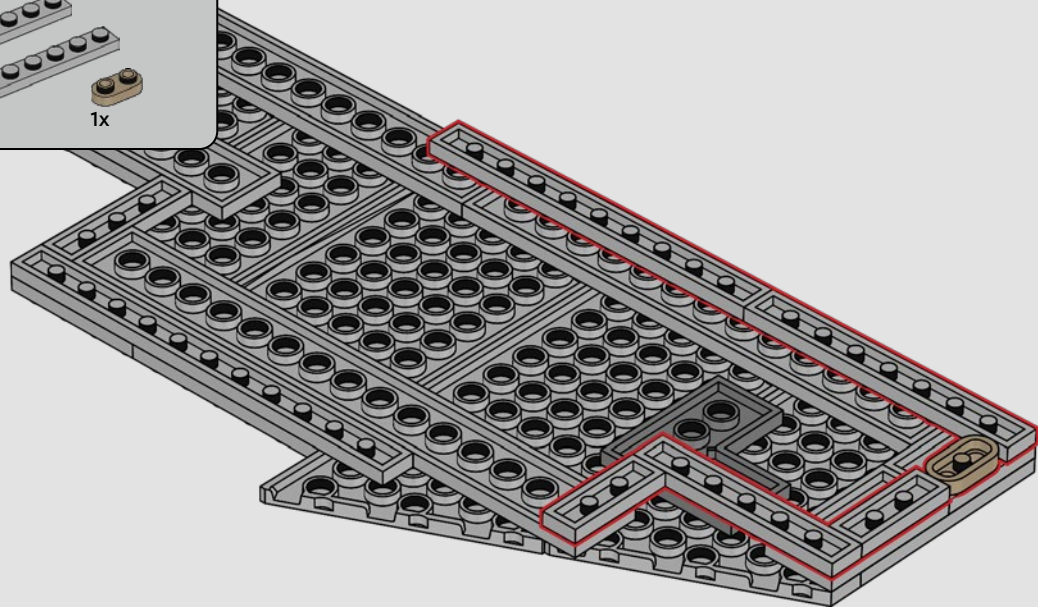
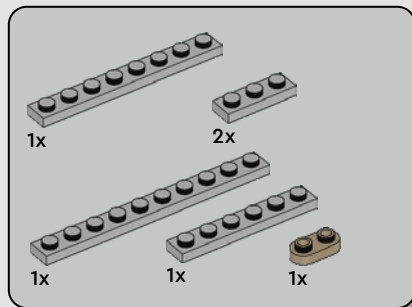

475

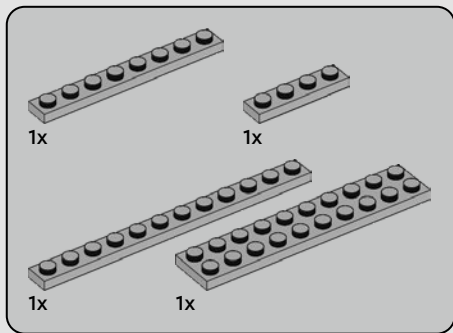

476

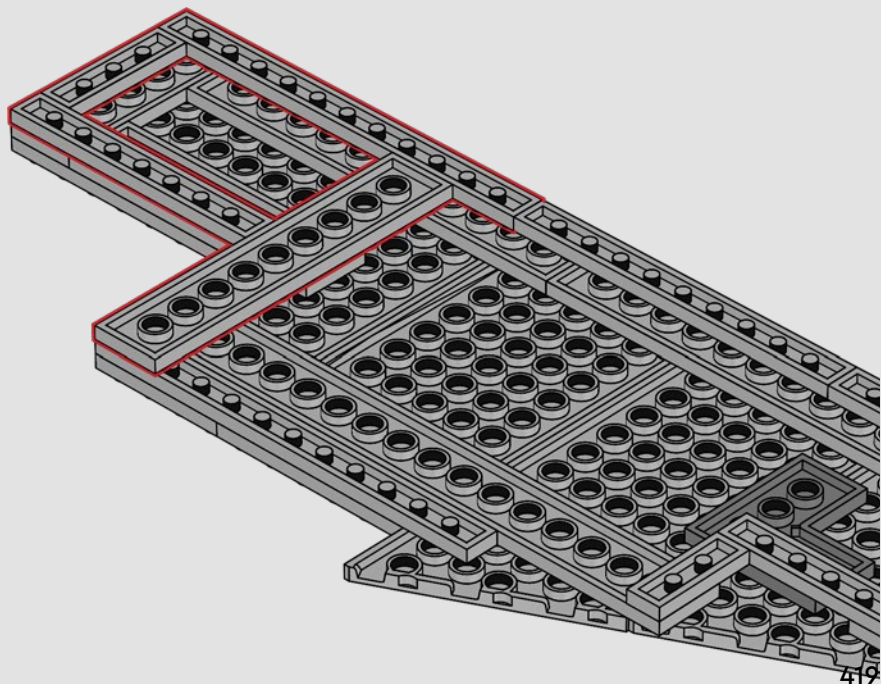

477



420

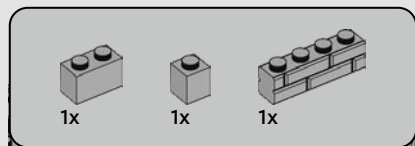

478

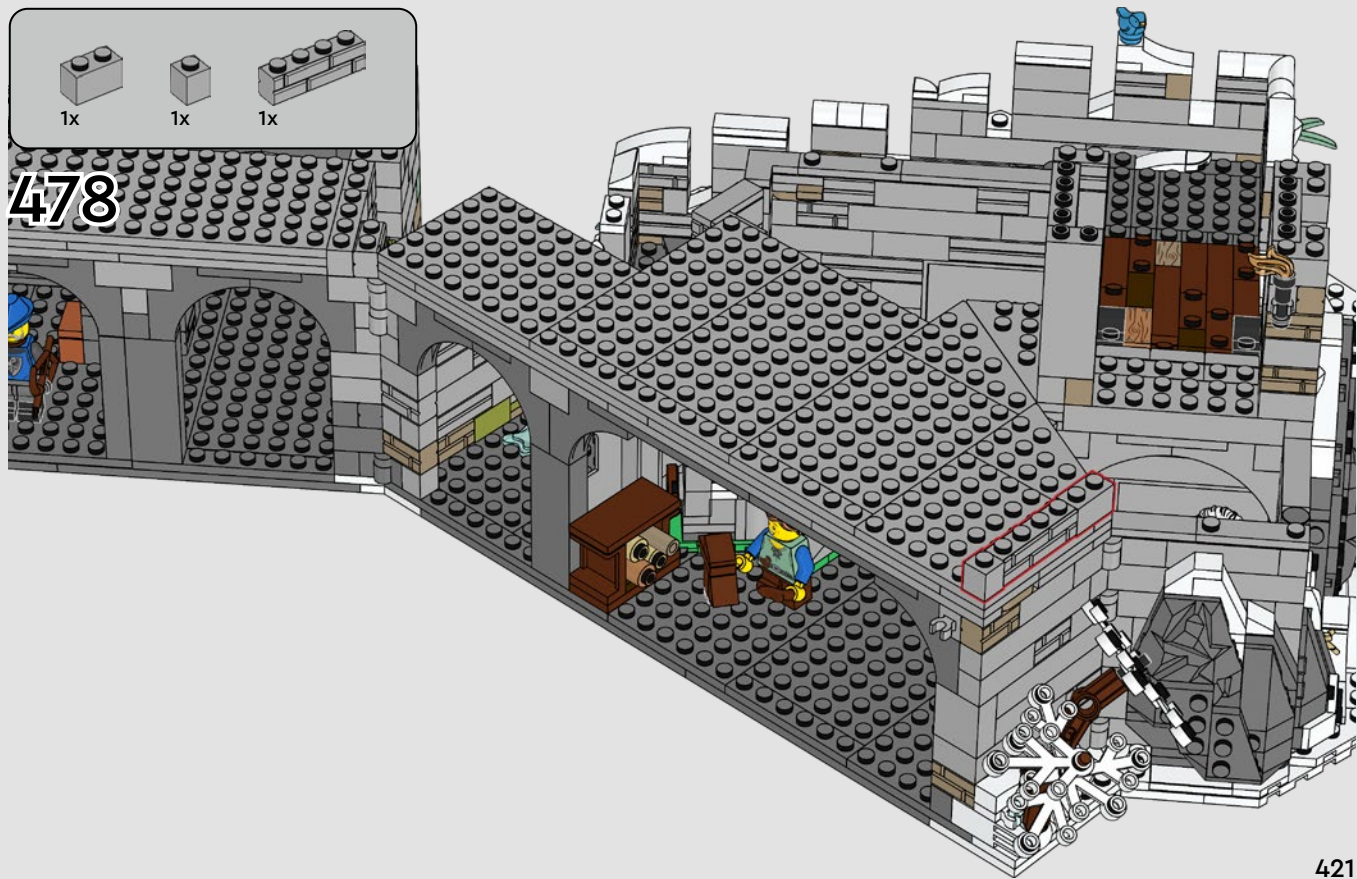



479



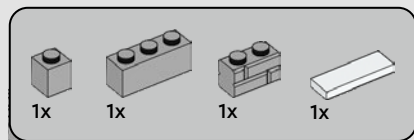

480

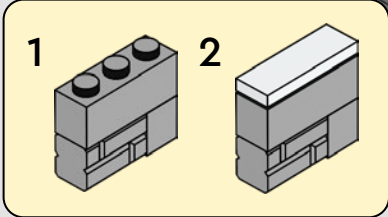
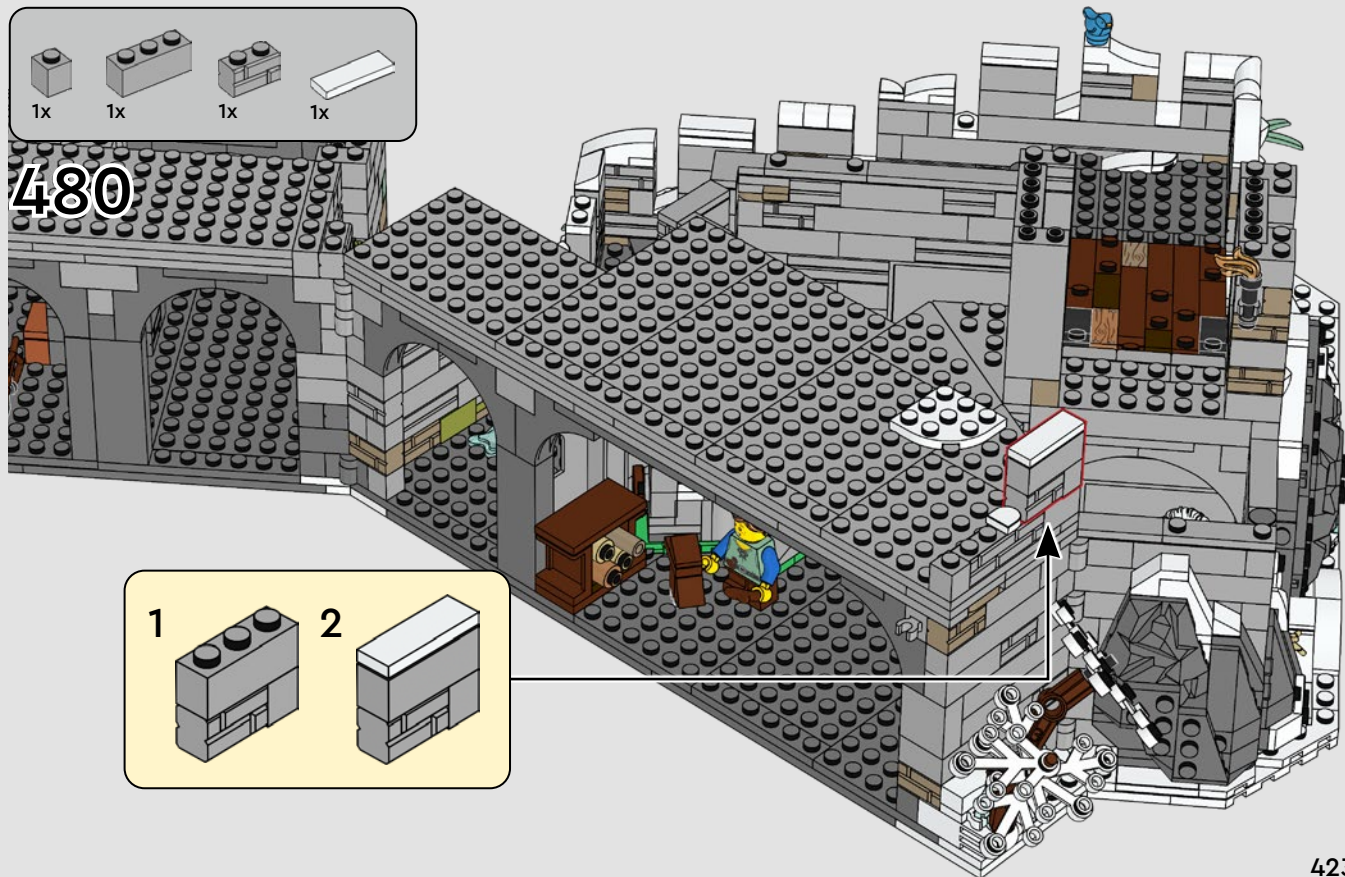

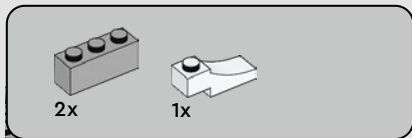

481

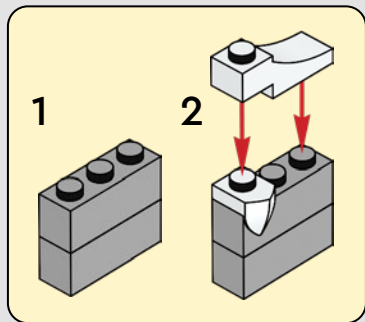
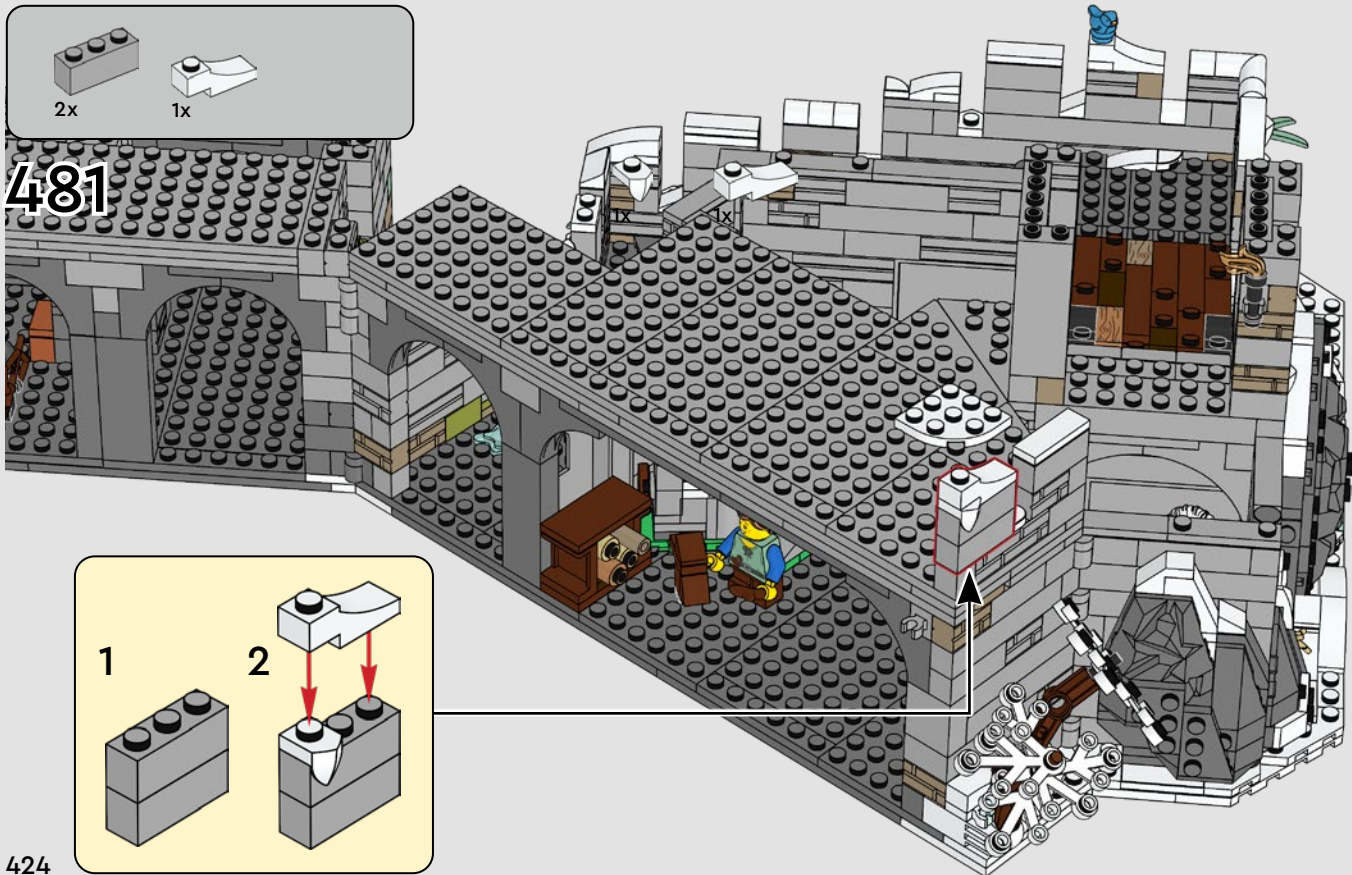

482



425

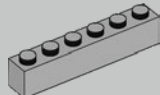

2x

483

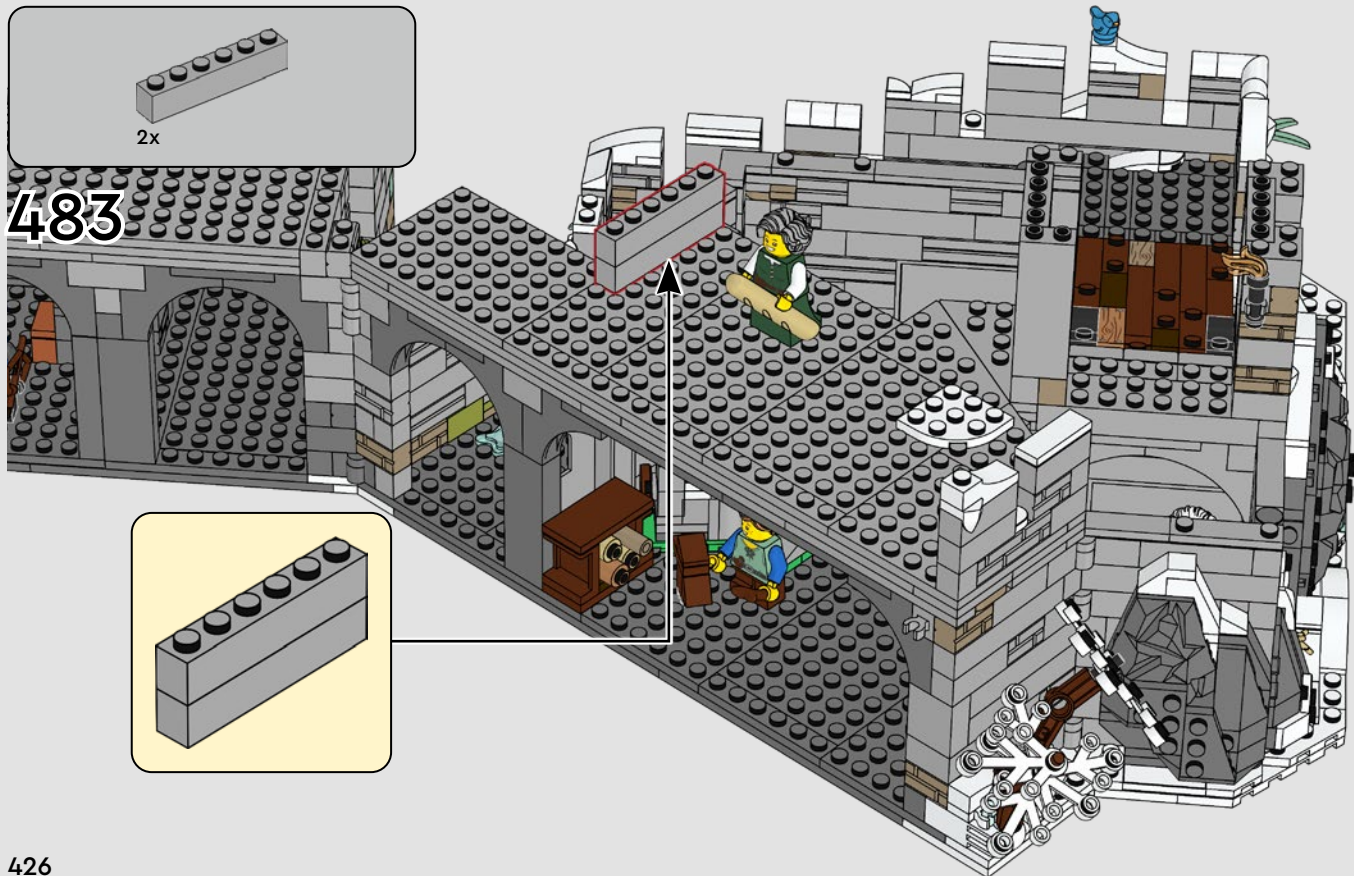

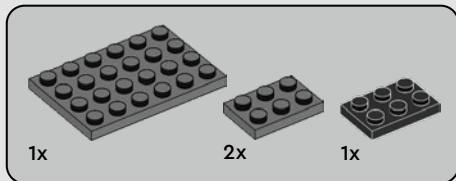
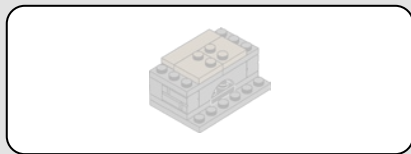

484

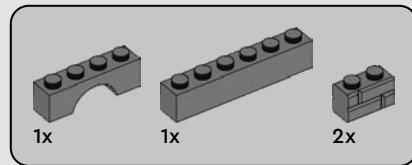
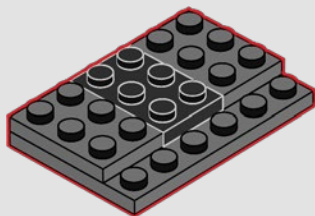

485

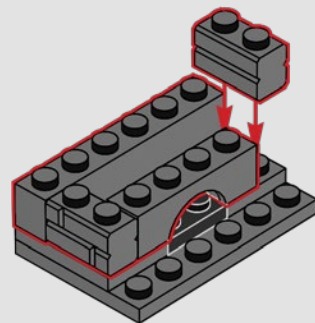



2x

486

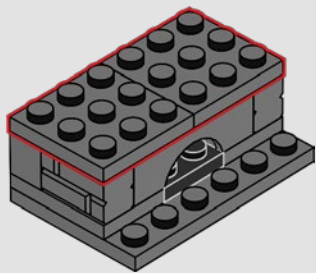

1x



2x

487

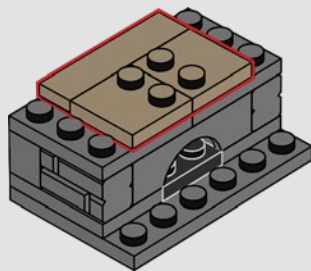

488



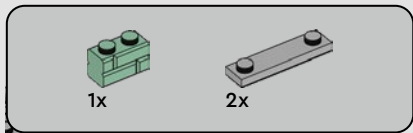

489



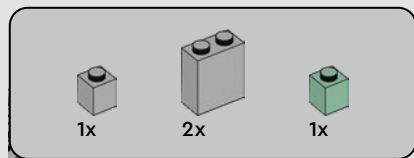

490





2x



2x

491

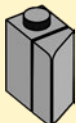
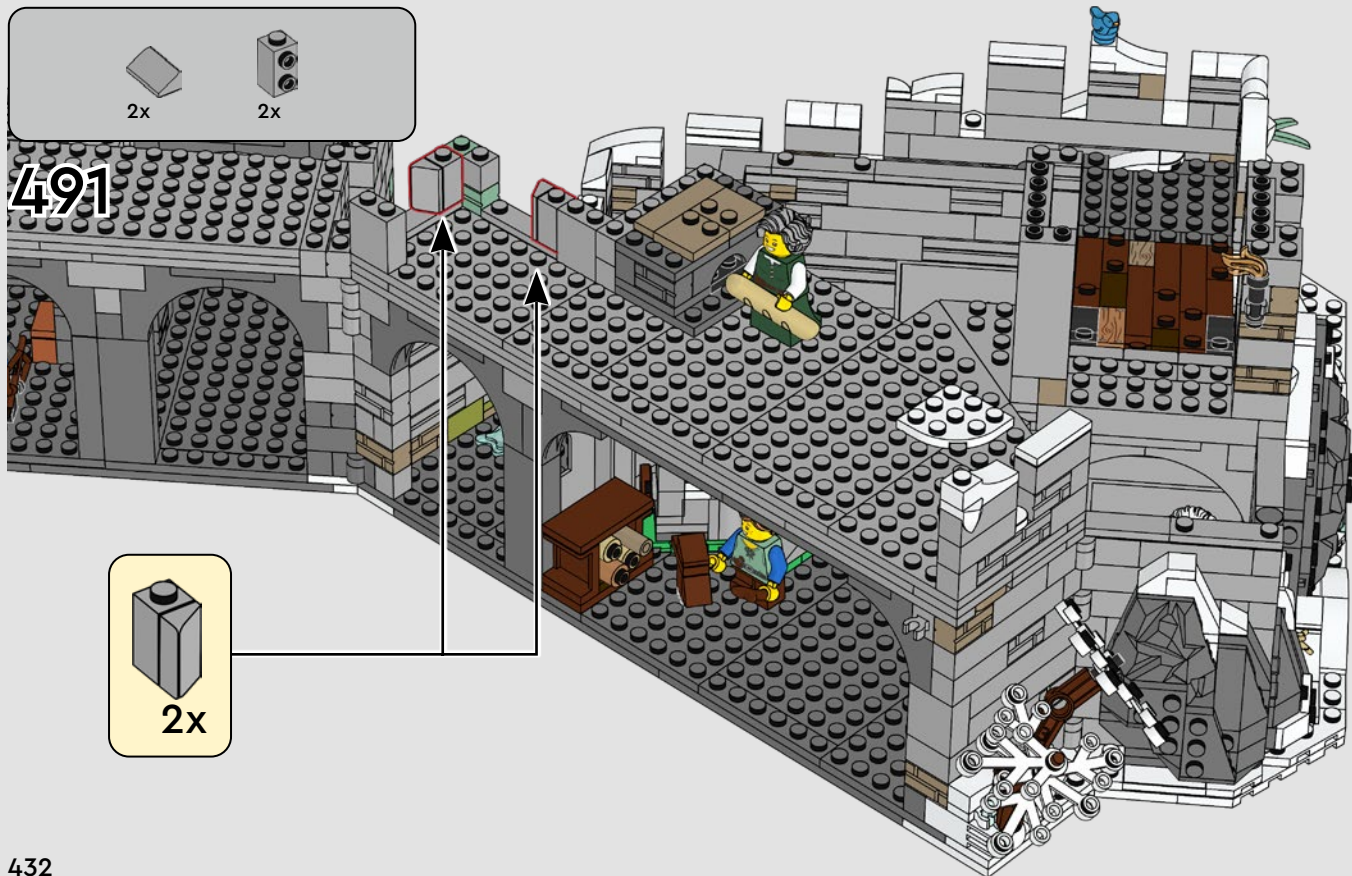

2x

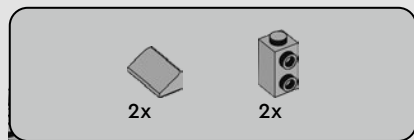

492

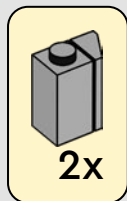

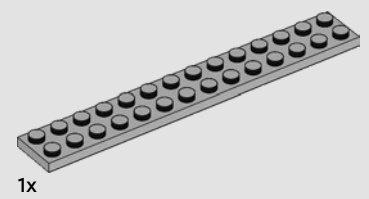
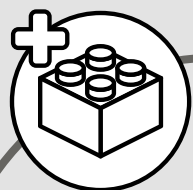
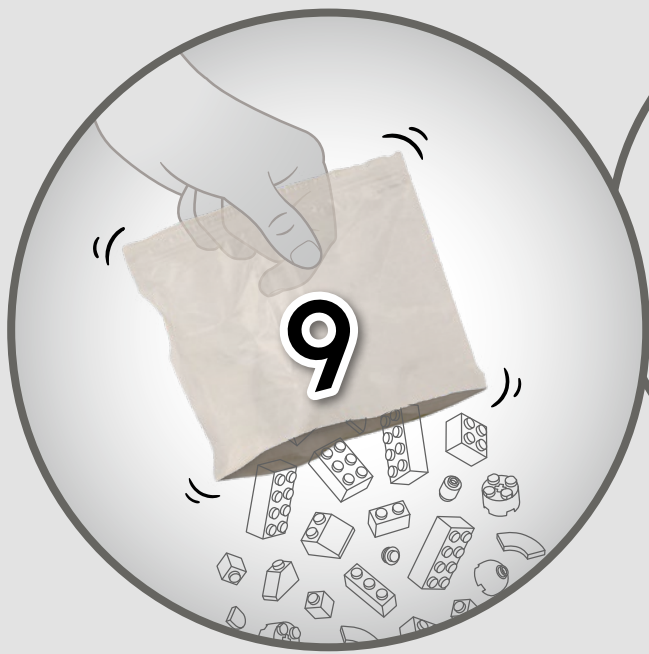

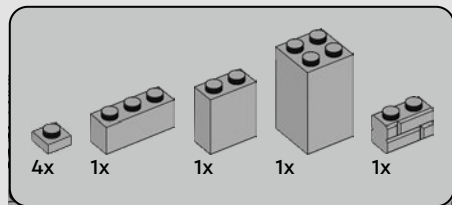

493

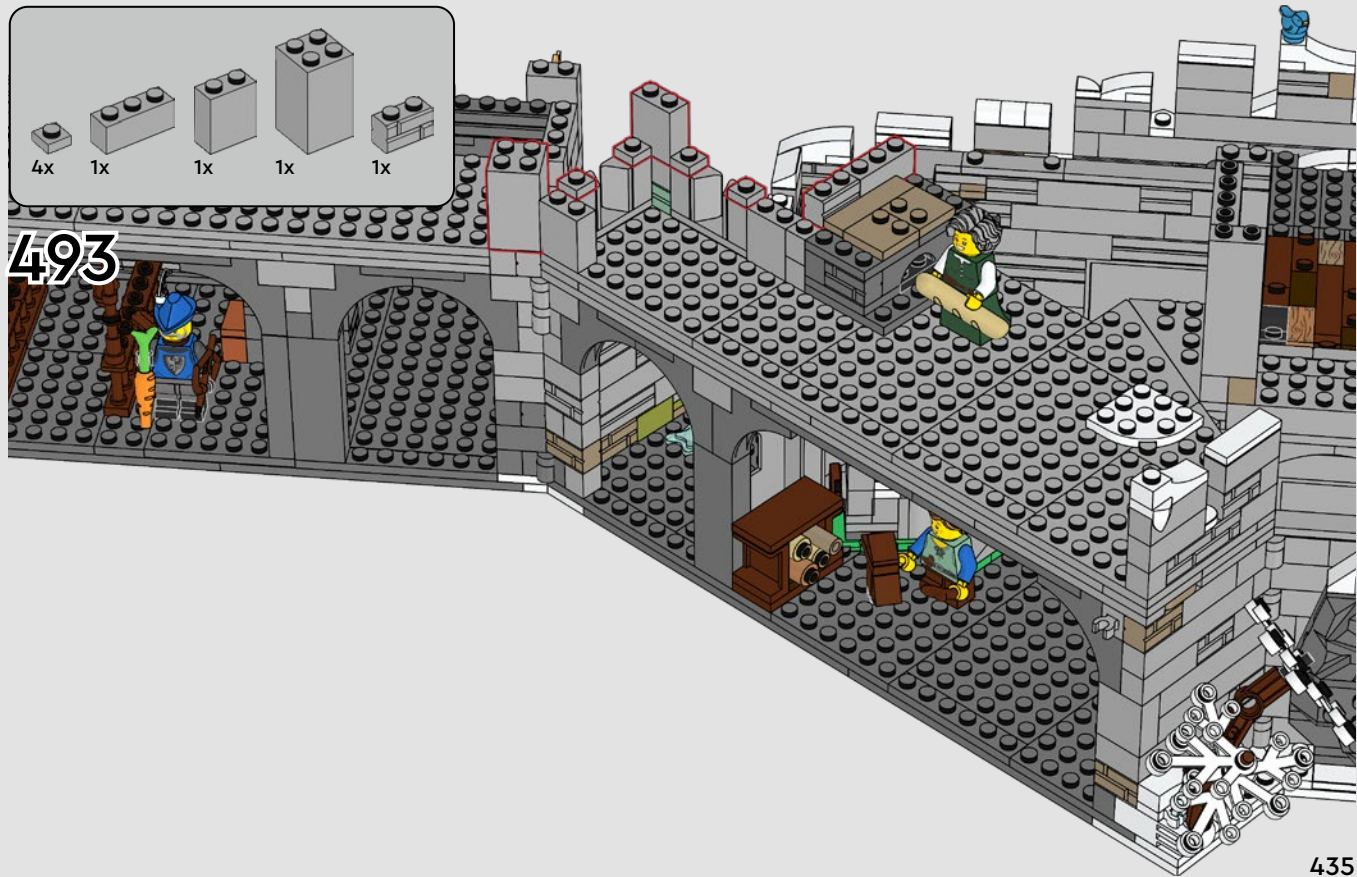

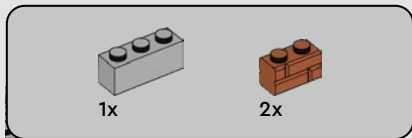

494



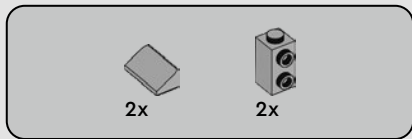

495

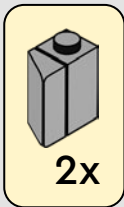

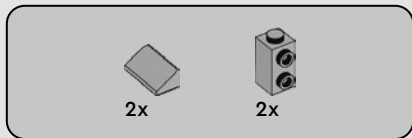

492

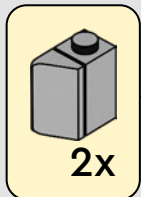

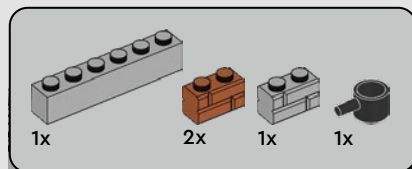

493



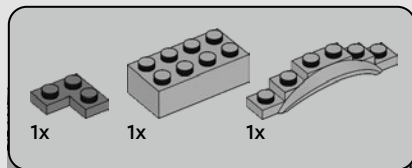

494





1x



2x

495



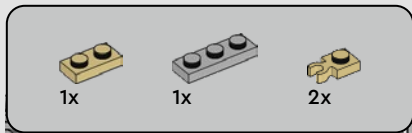

496





2x

497





1x



2x

498







1x



1x

499



1x  2x 

500



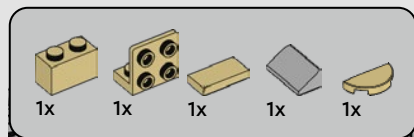

501

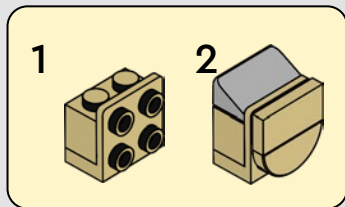
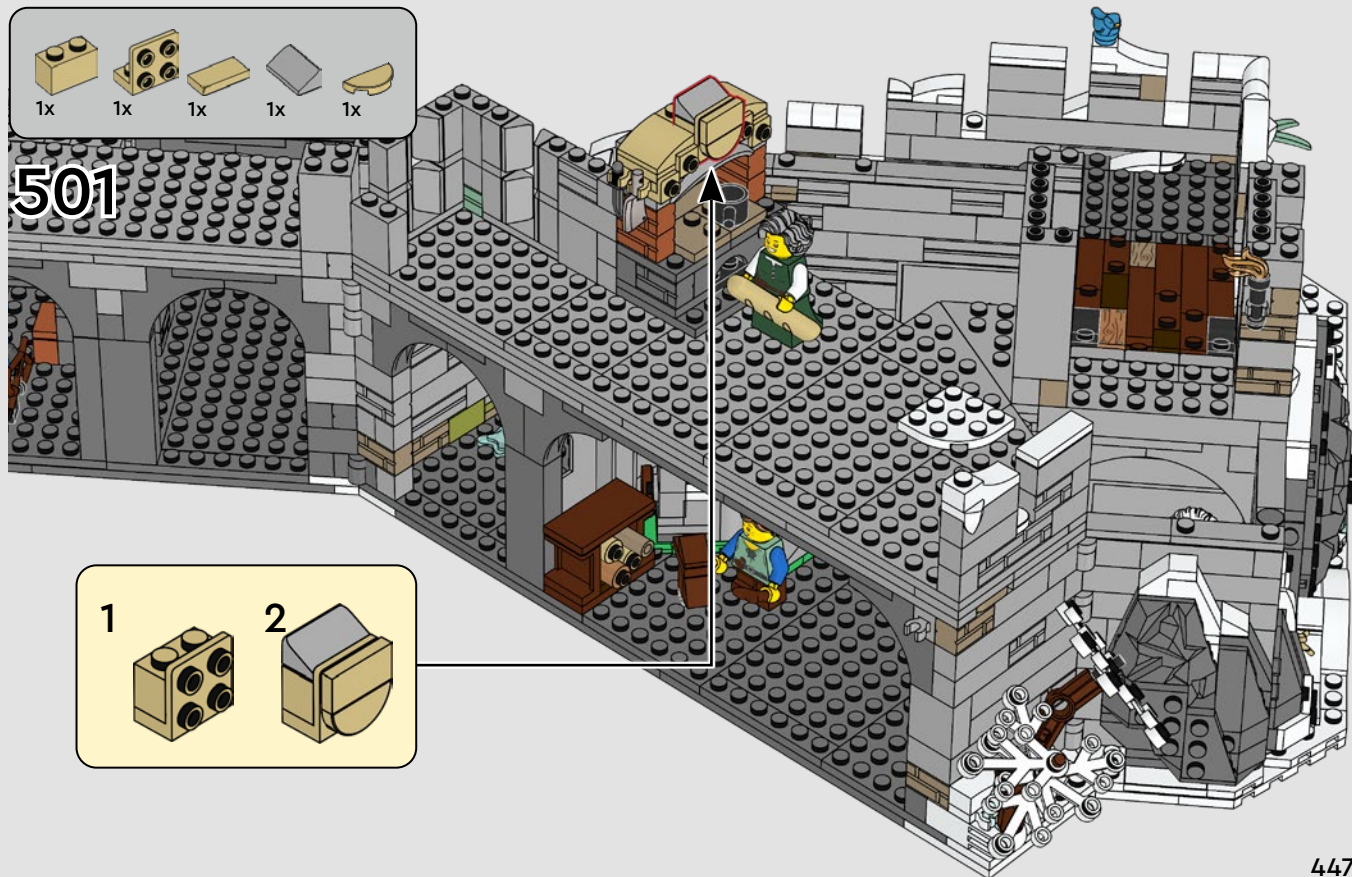



4x

502



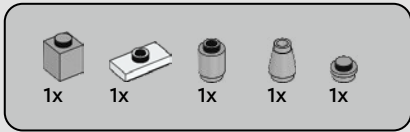

503

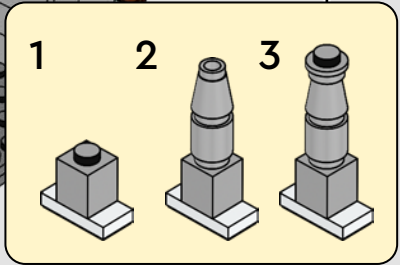
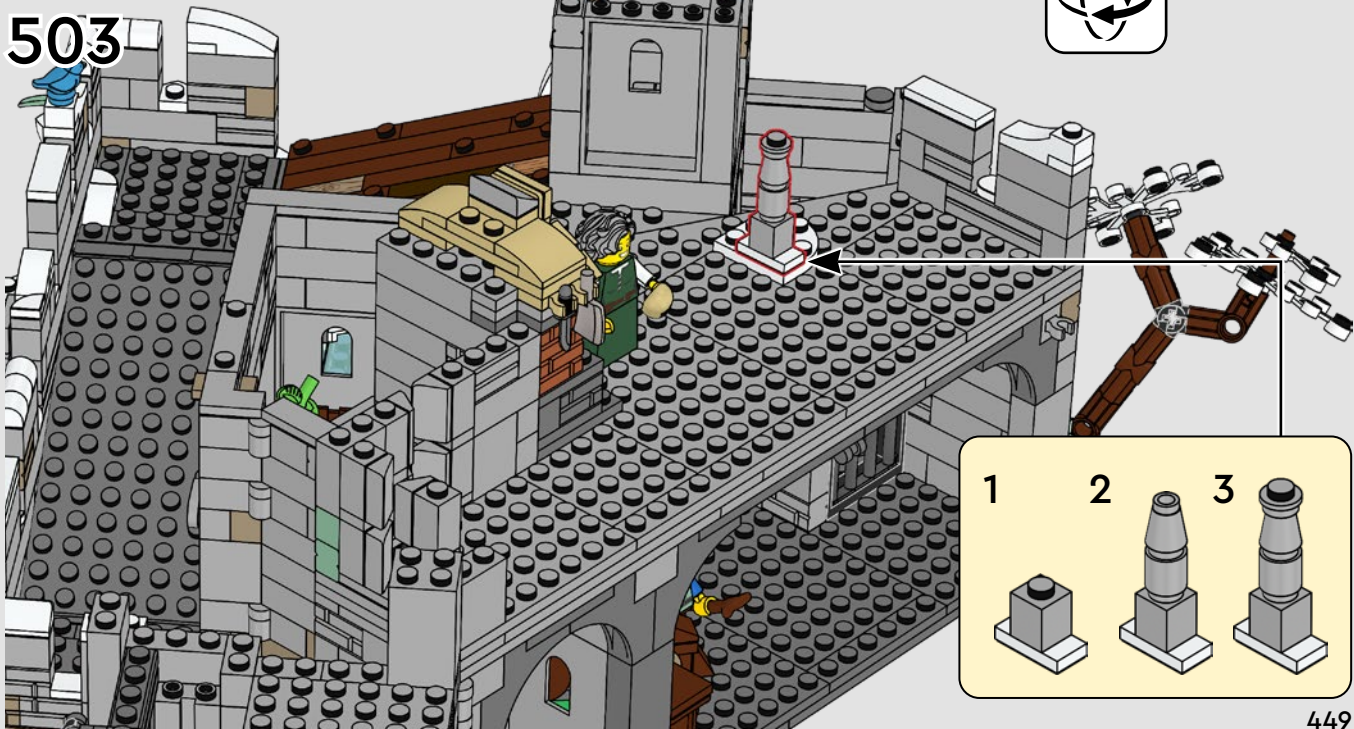

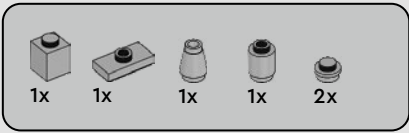

504

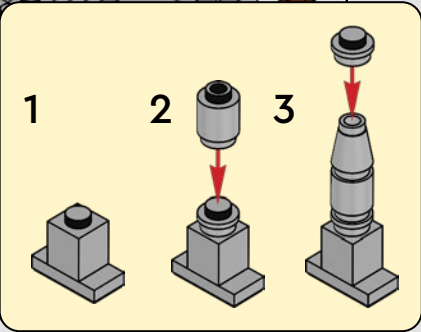
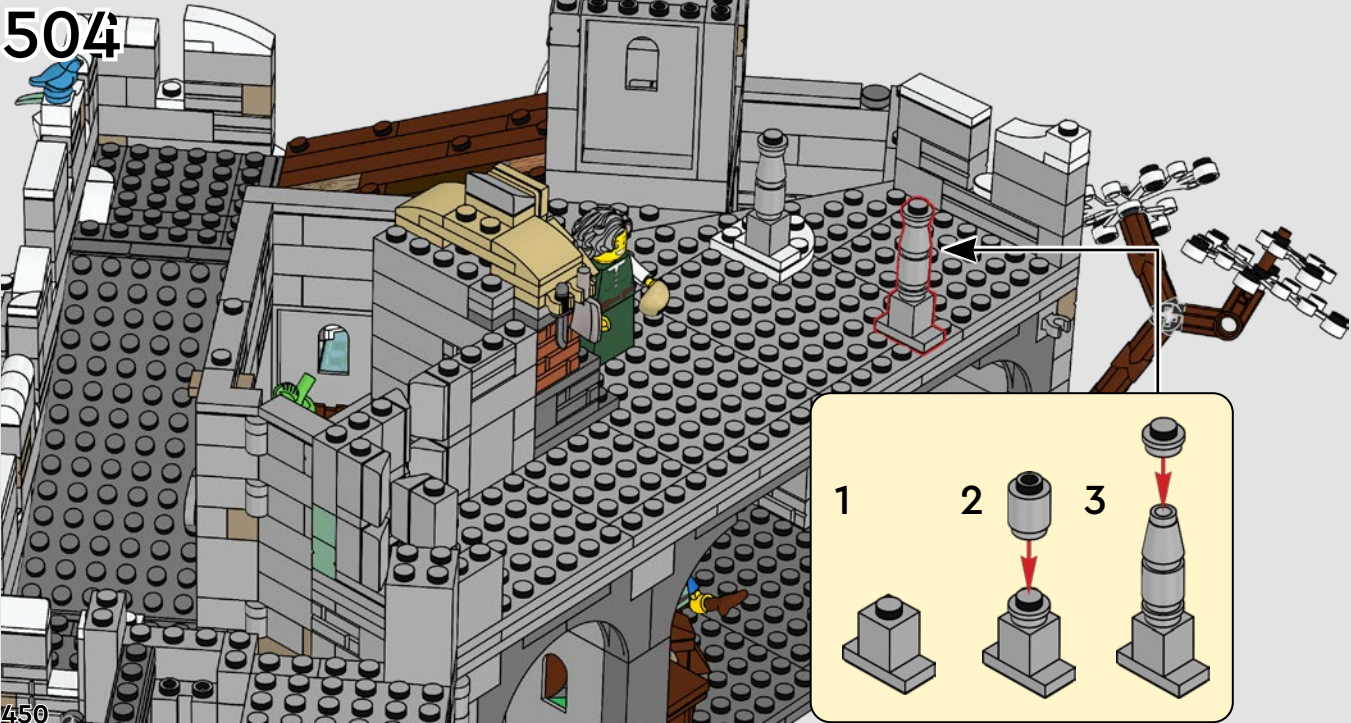

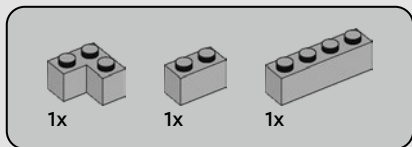

505

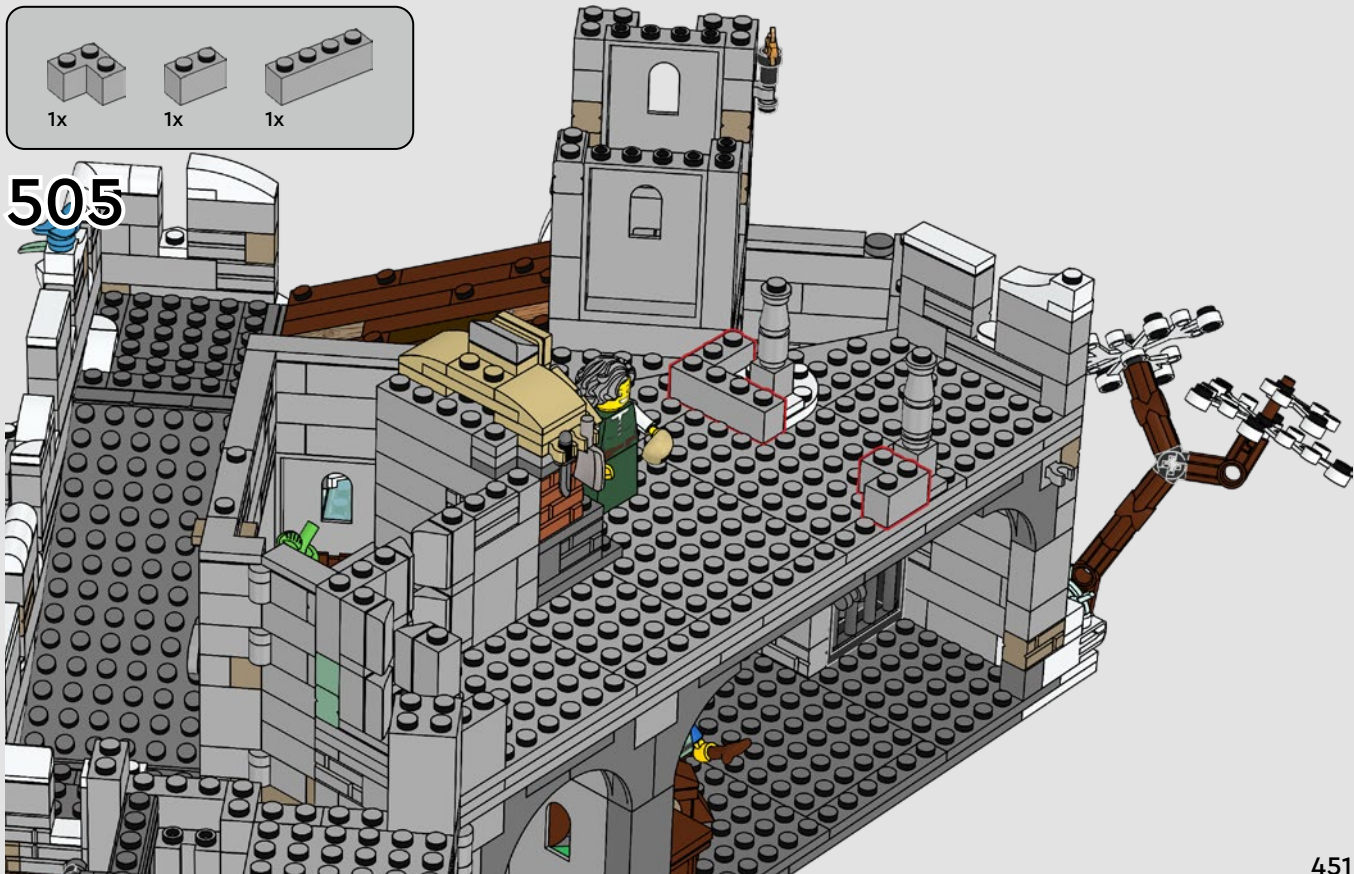

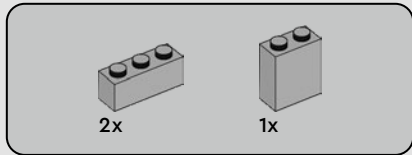

506

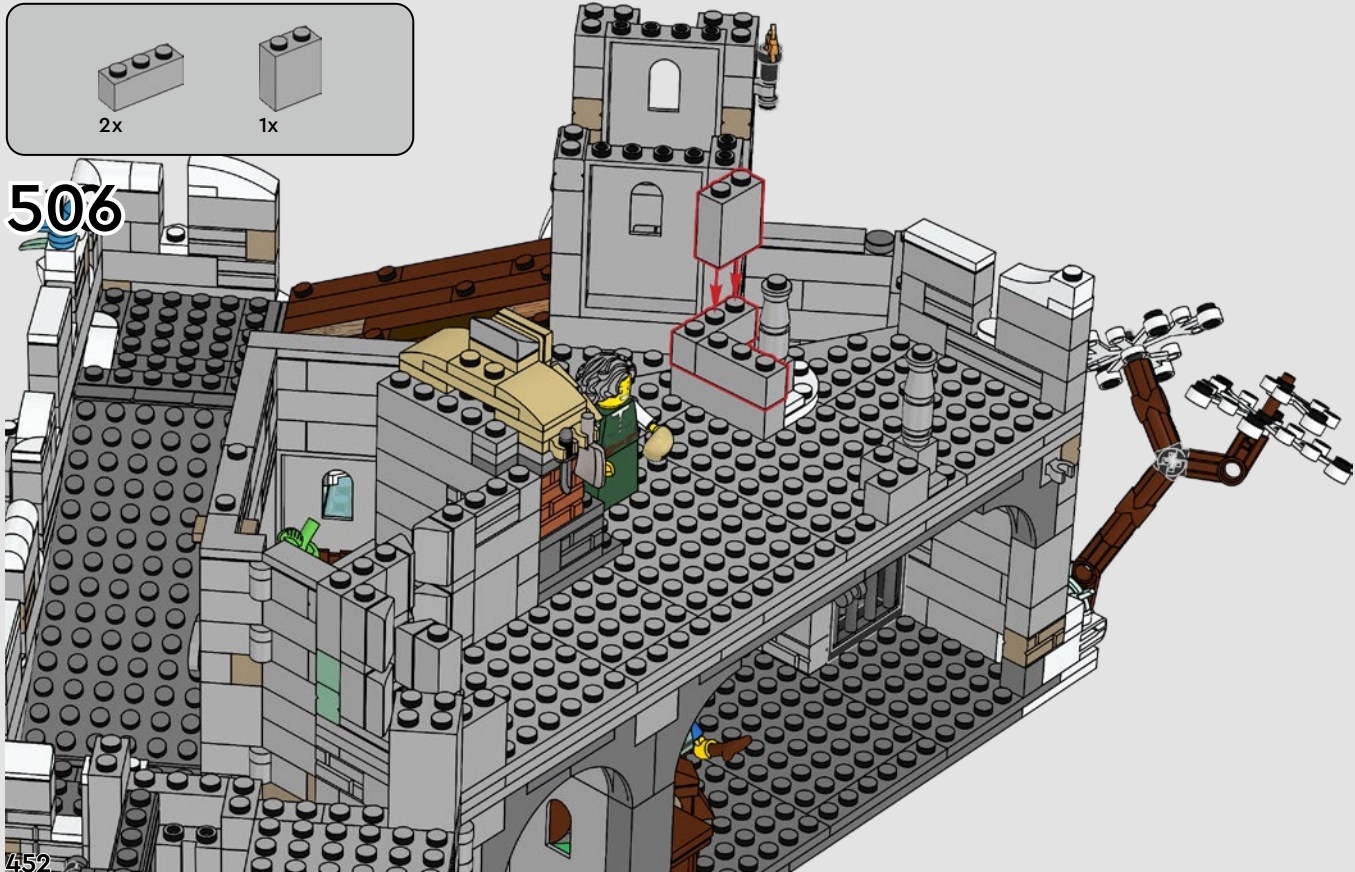

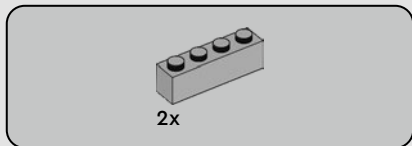

507

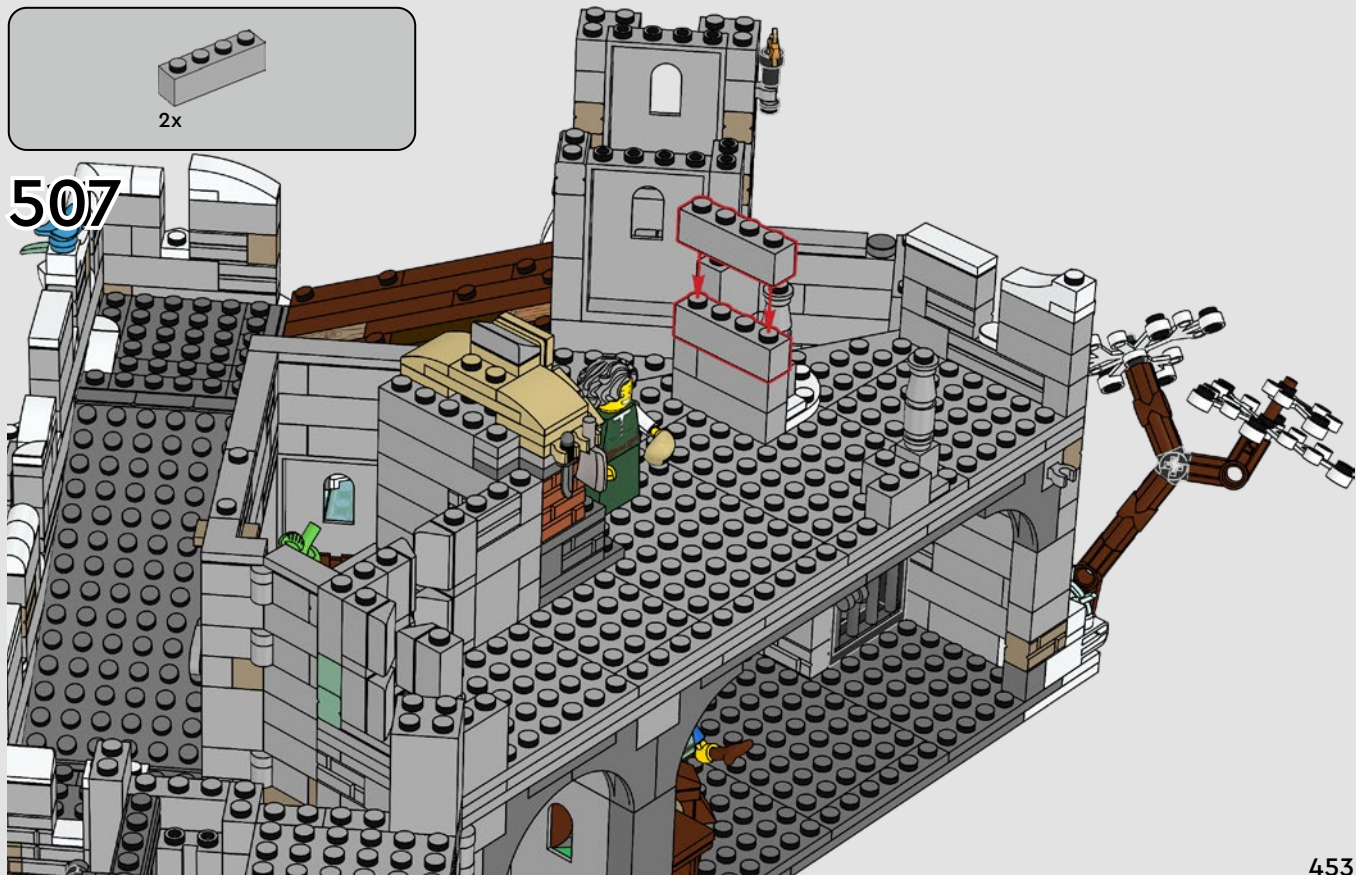



2x

508

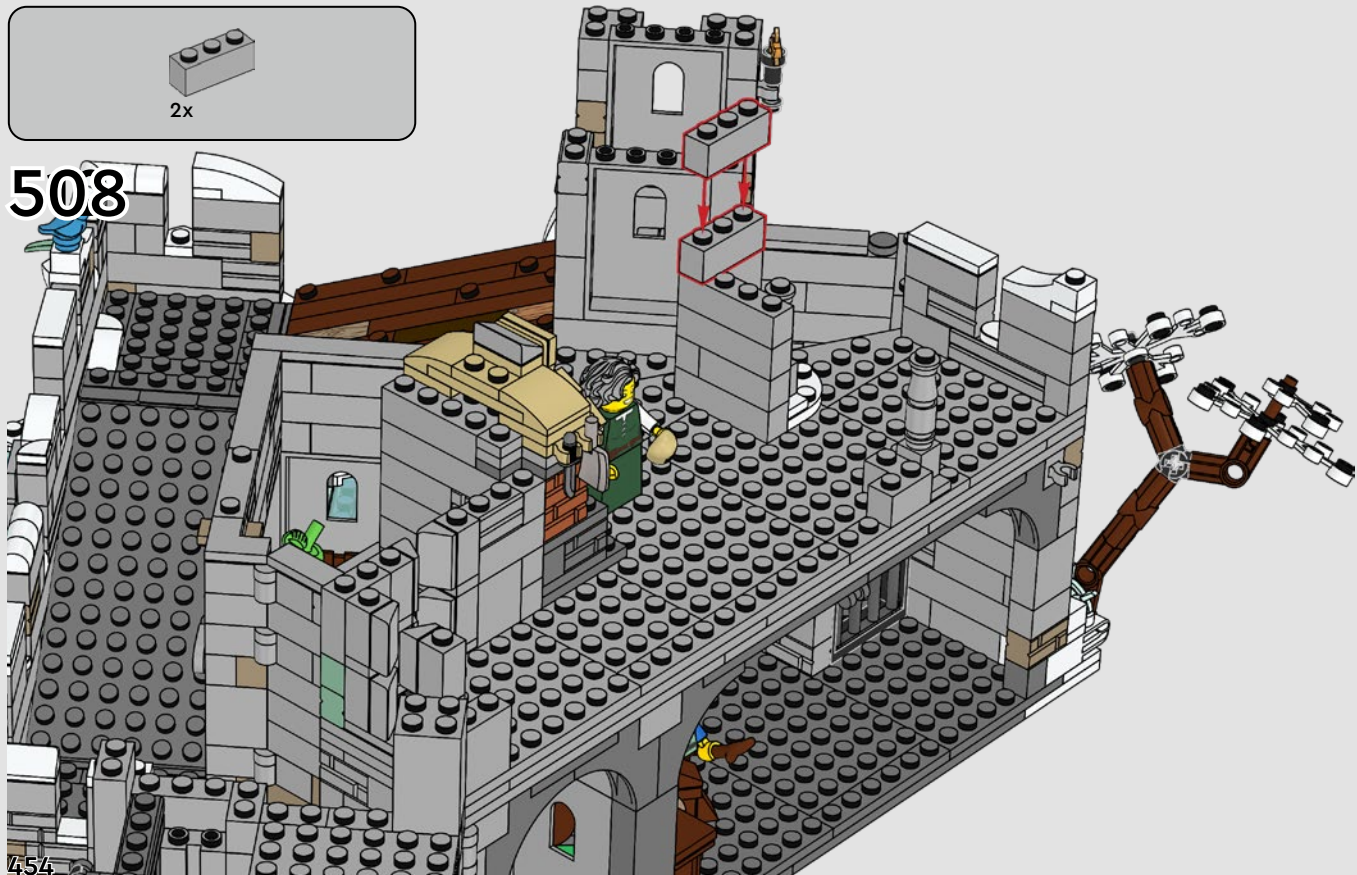



509

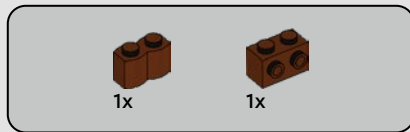

510

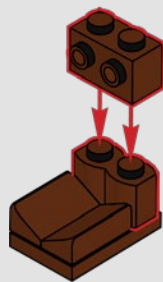

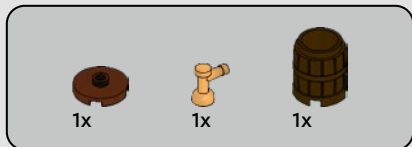

511

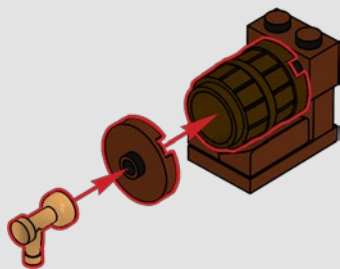

512

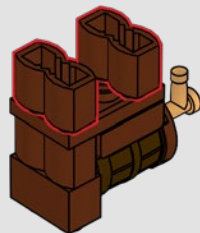

513

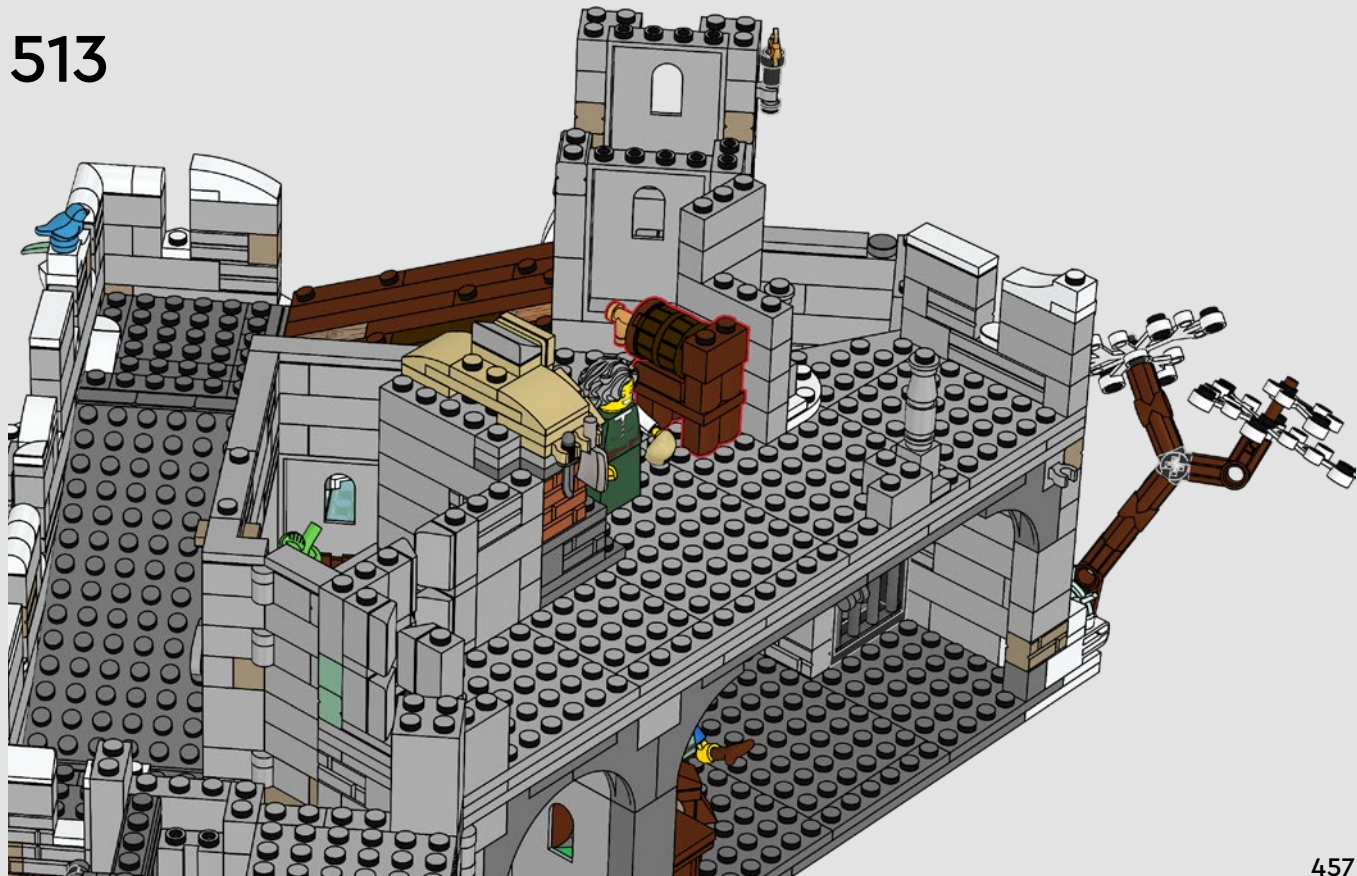

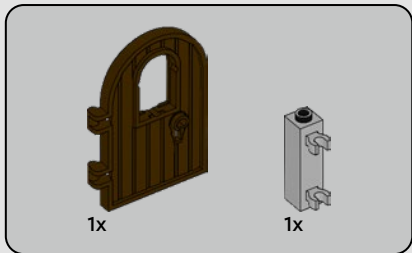

514

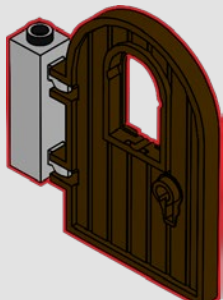

515

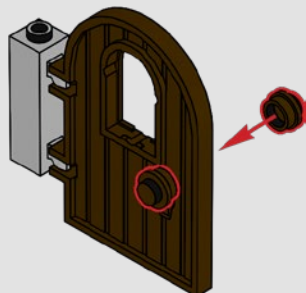

516

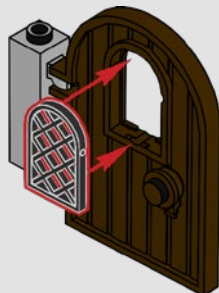

517

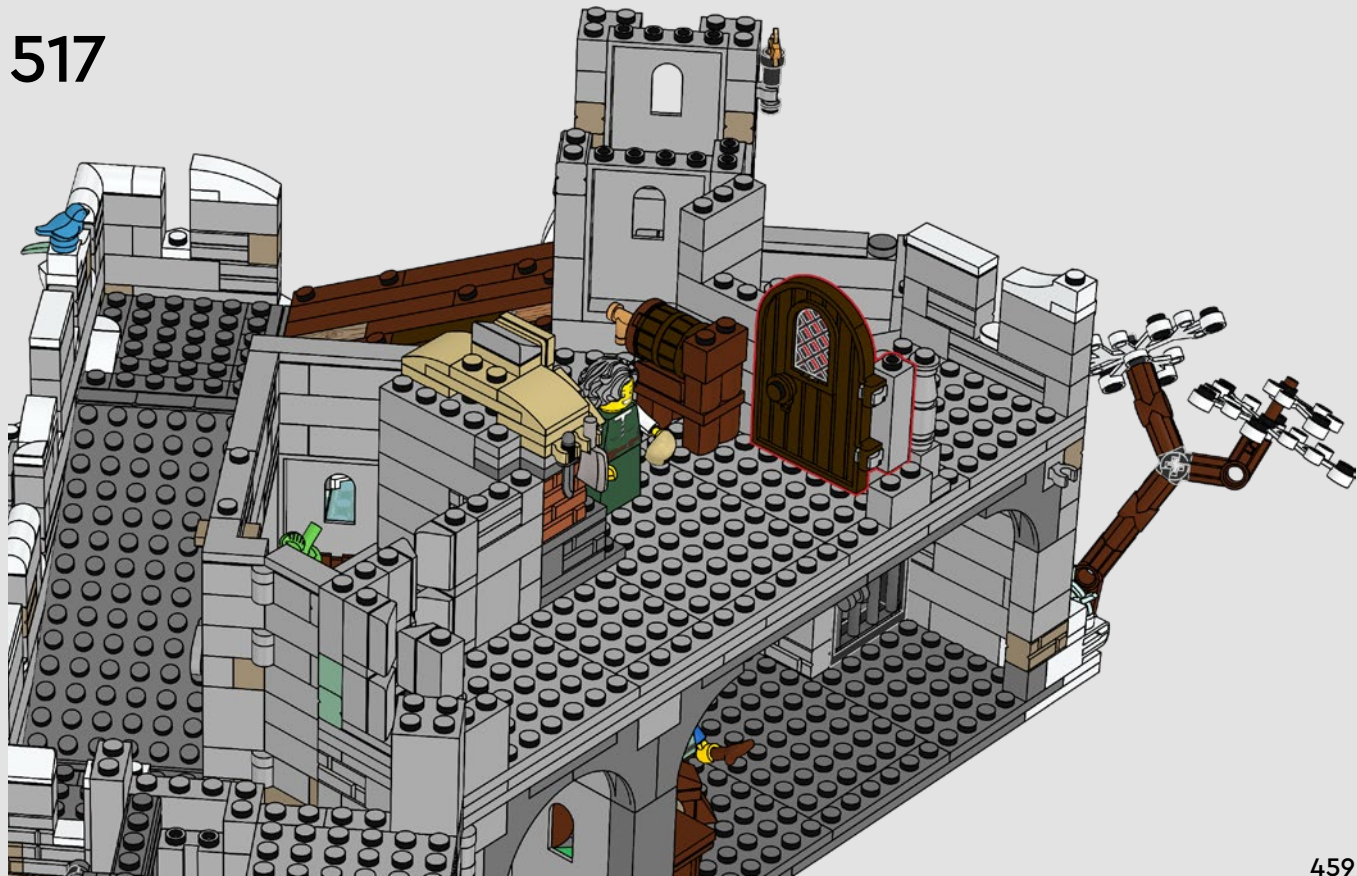

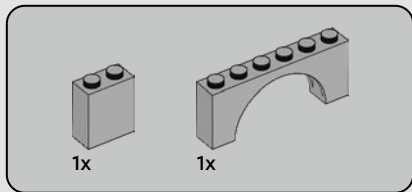

518

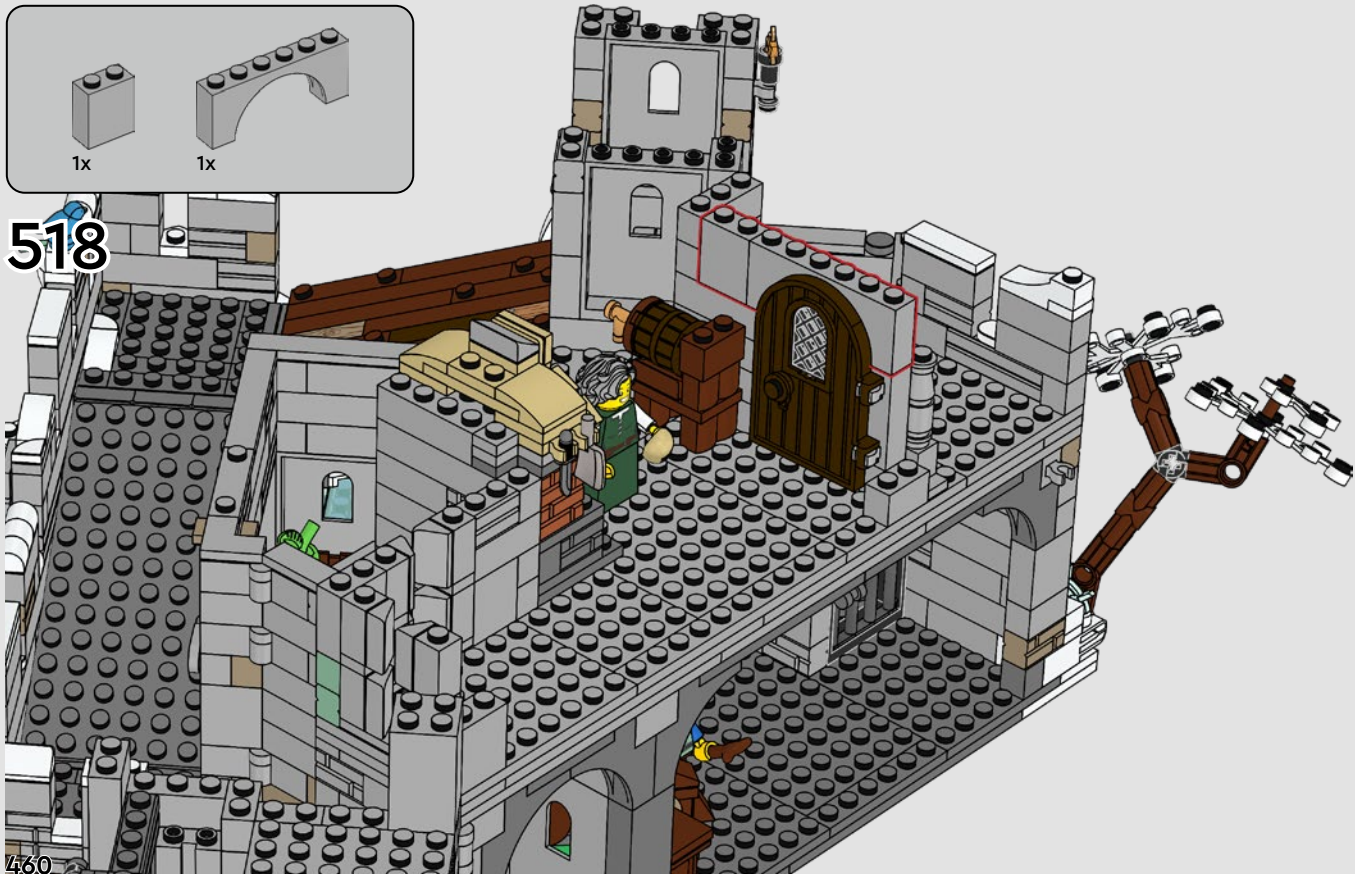



519

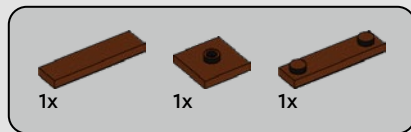
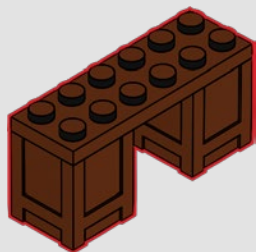

520

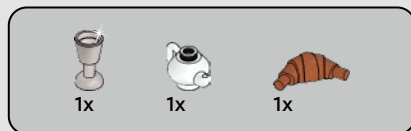

521



522



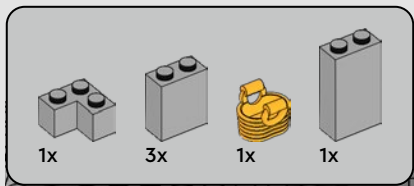

523



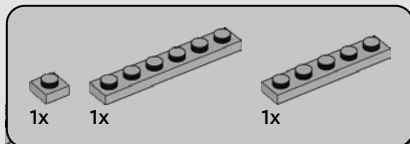

524





1x



1x

525

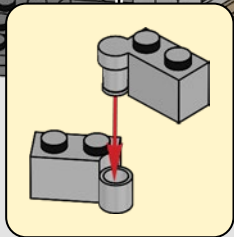
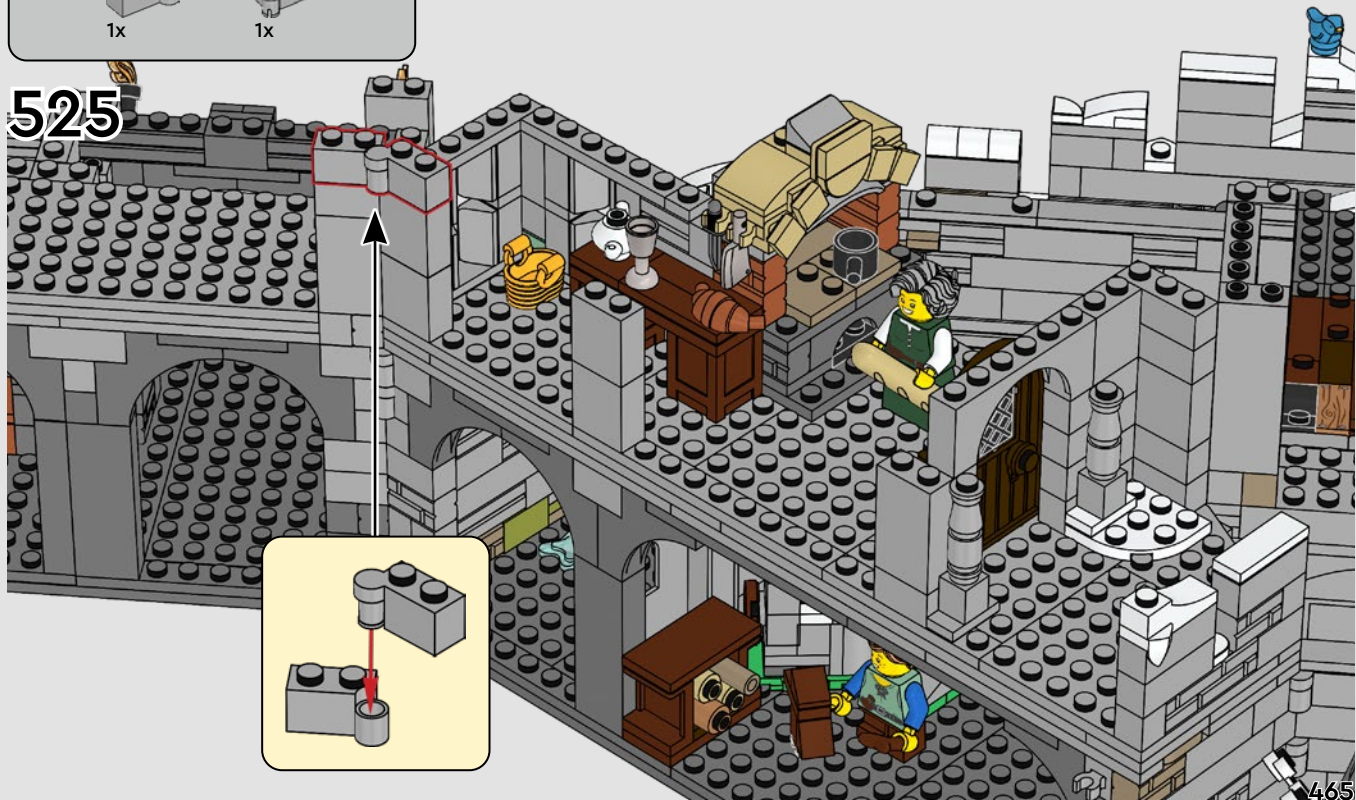



526

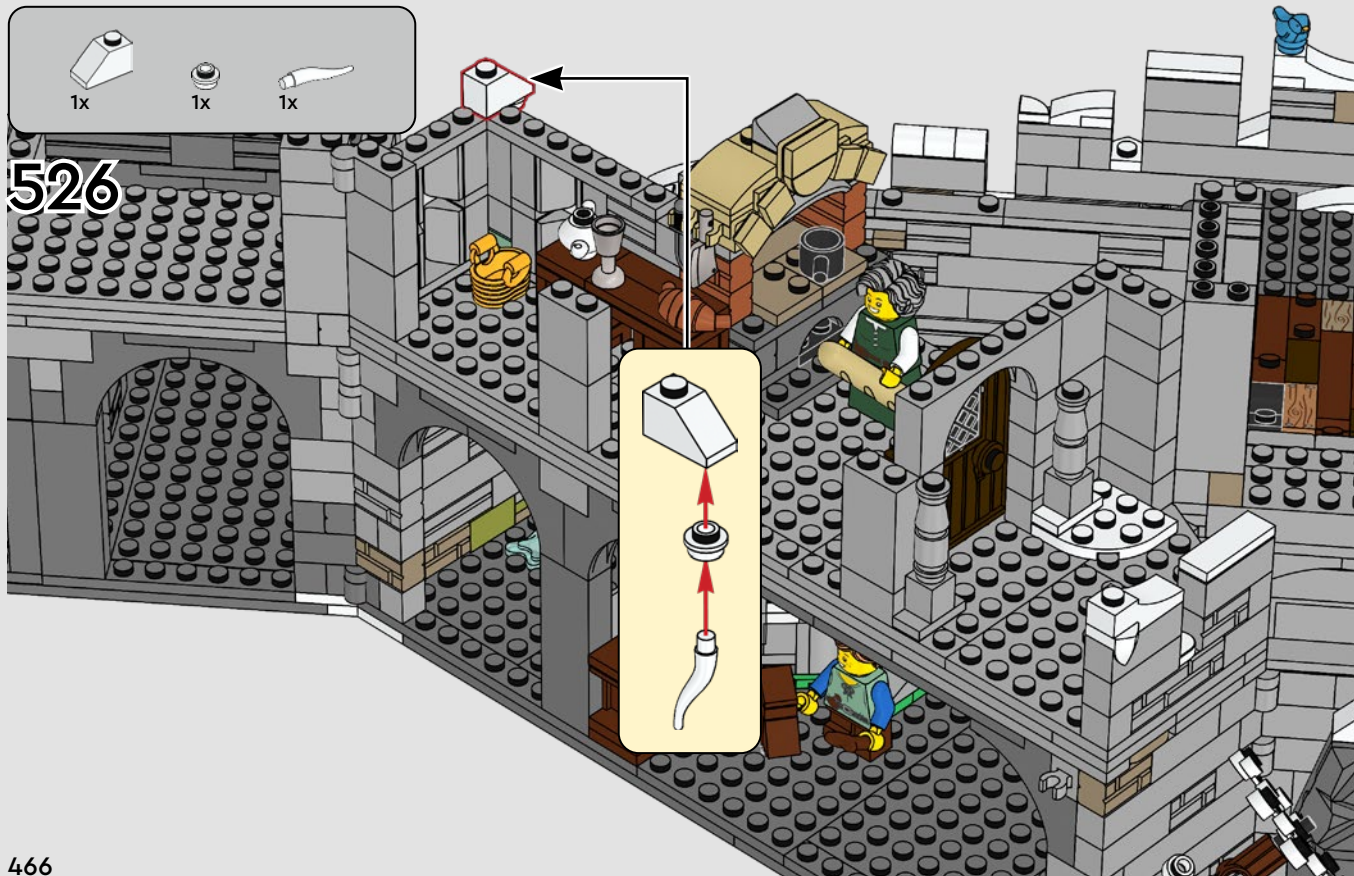

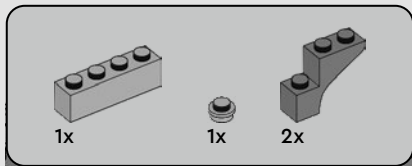

527



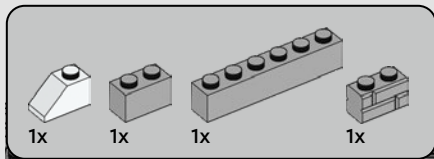

528



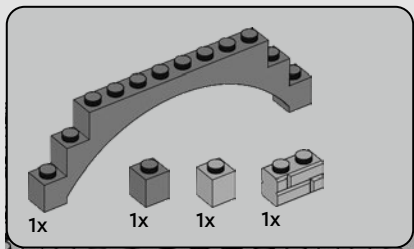

529



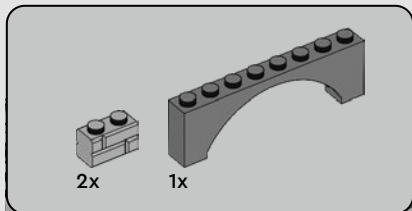

530



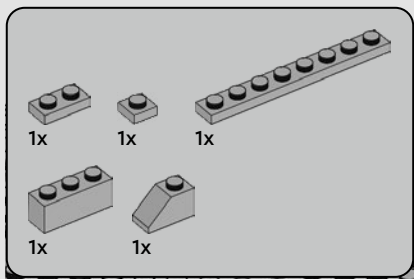

531



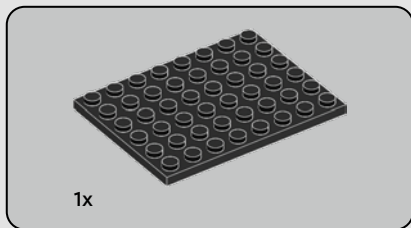

533

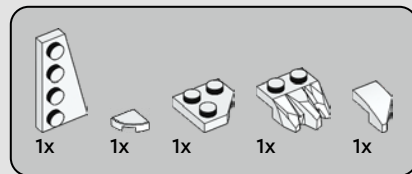
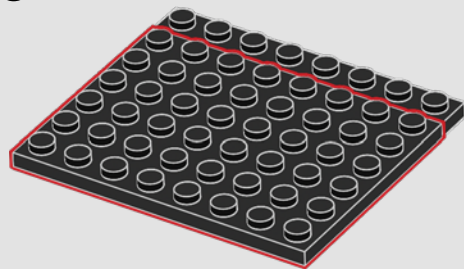

534



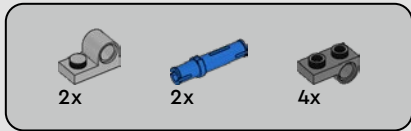

535

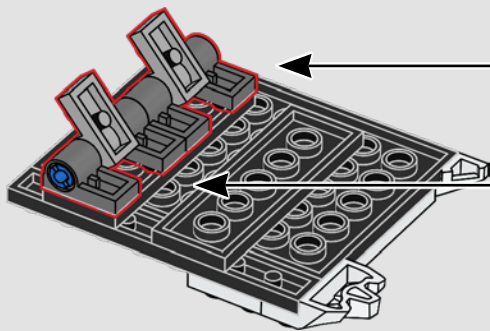
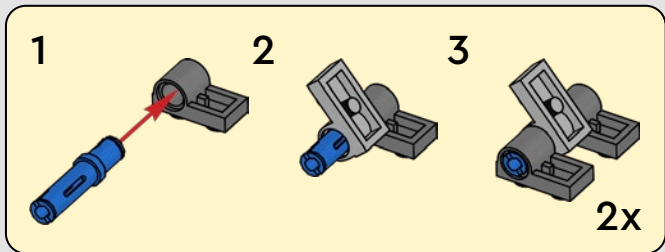

536



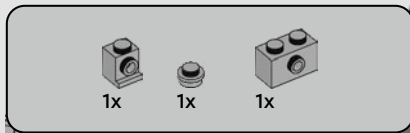

537

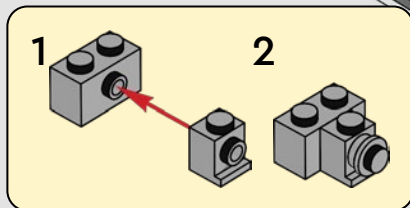
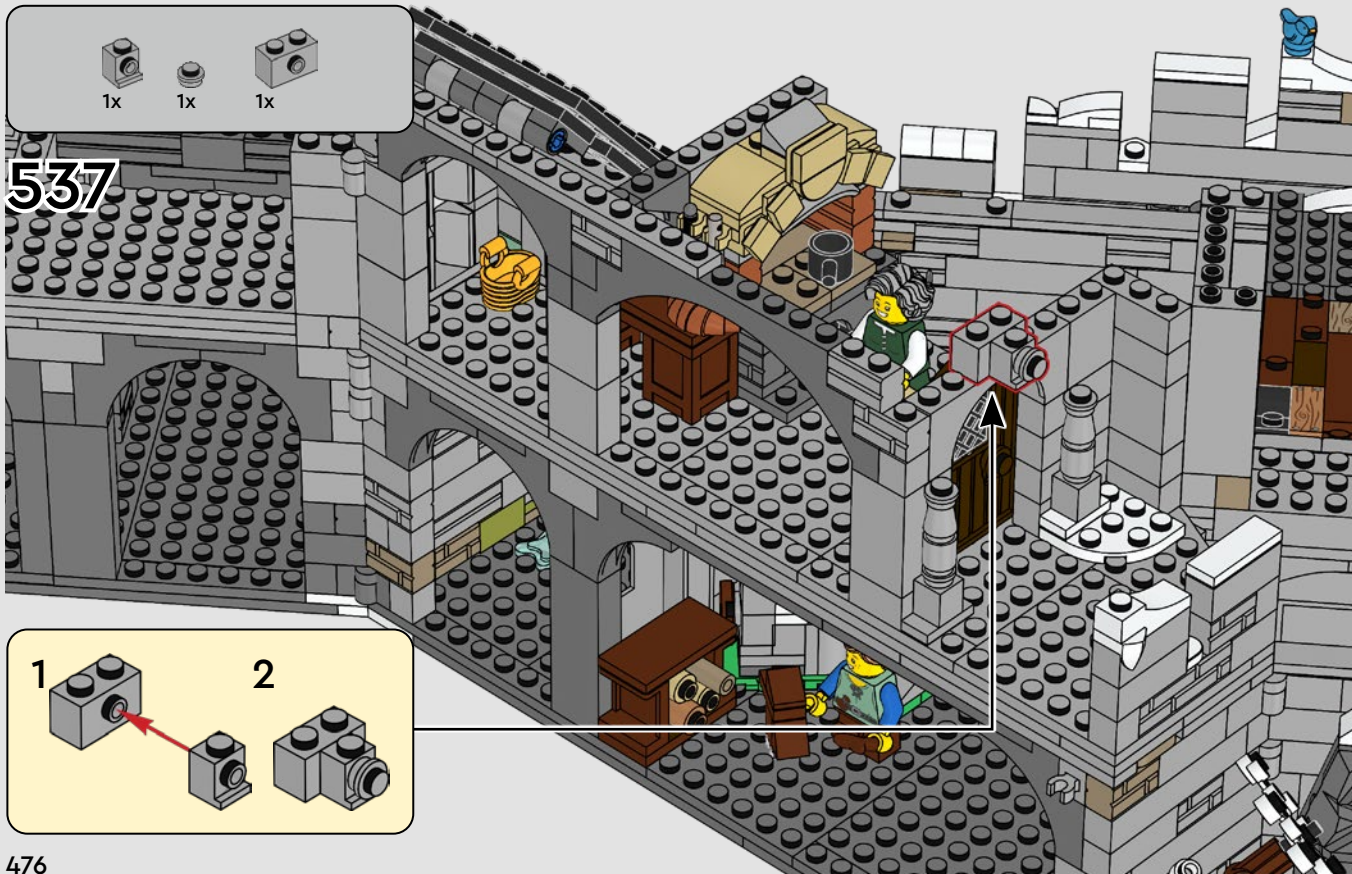

2x

1x

1x

538



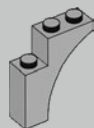

2x

539

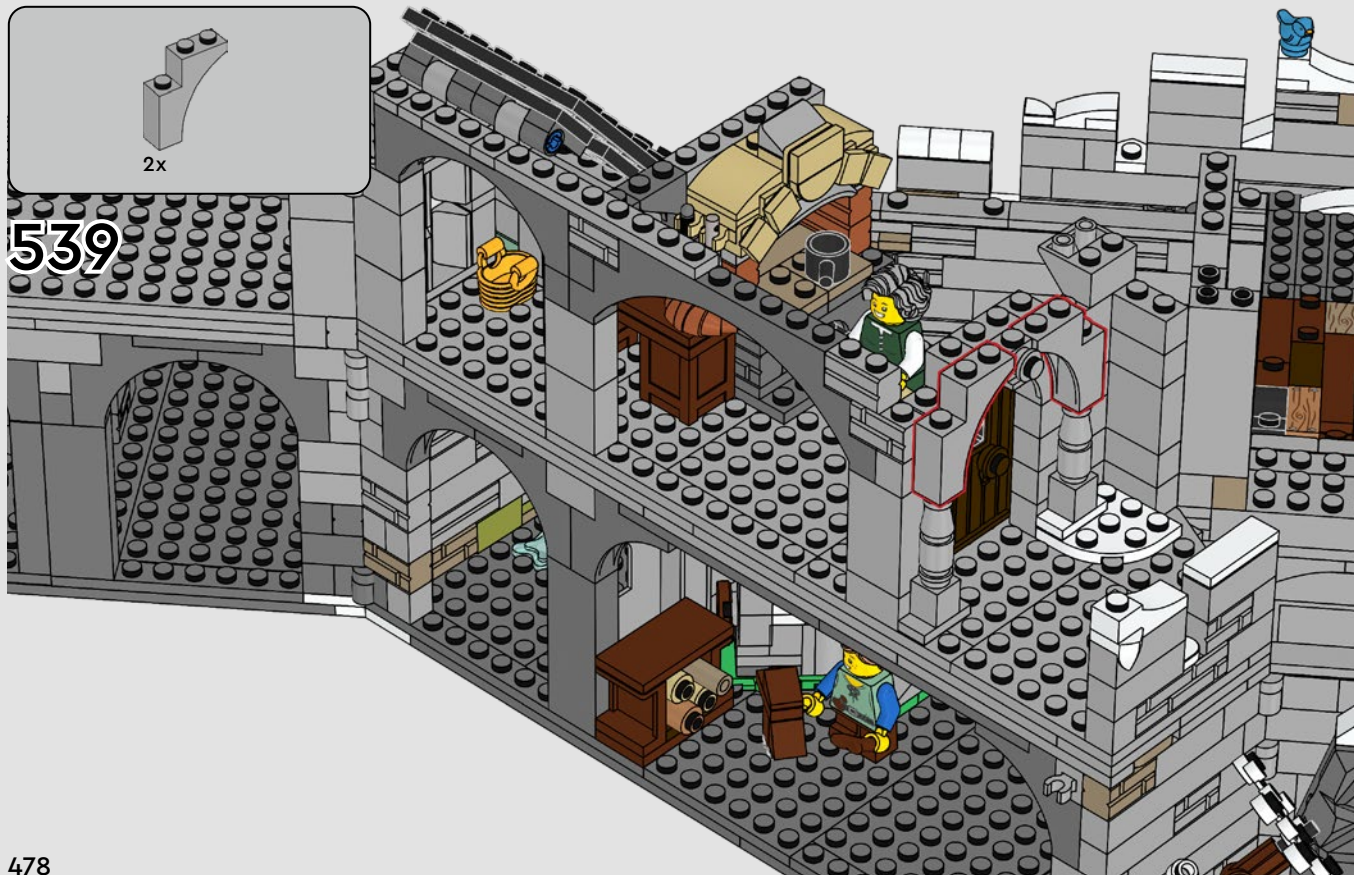



2x



2x



2x

540

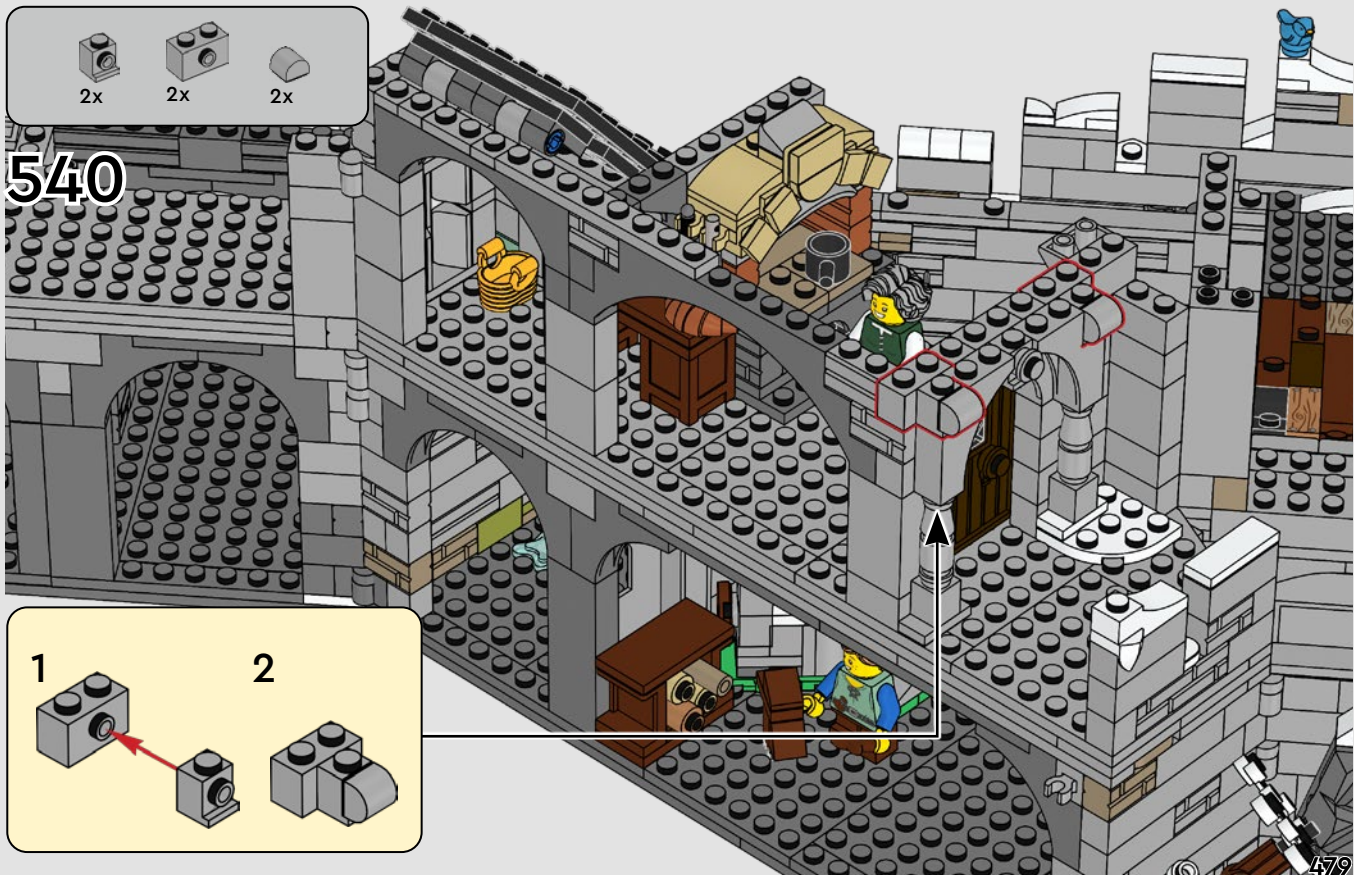

1

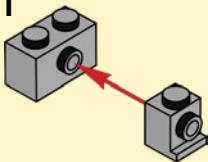

2

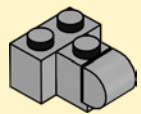

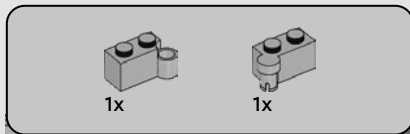

541

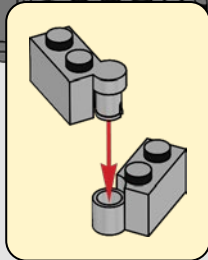

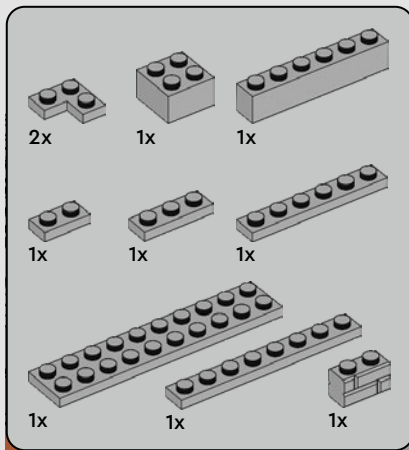

542



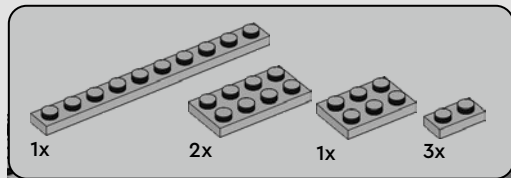

543



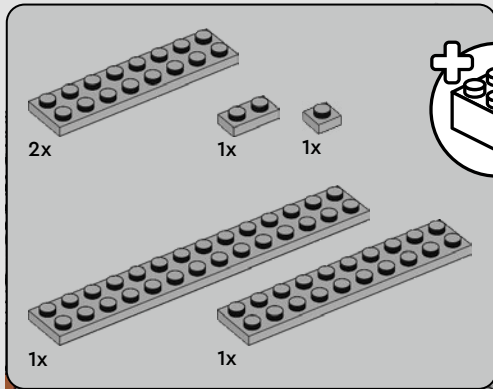

544



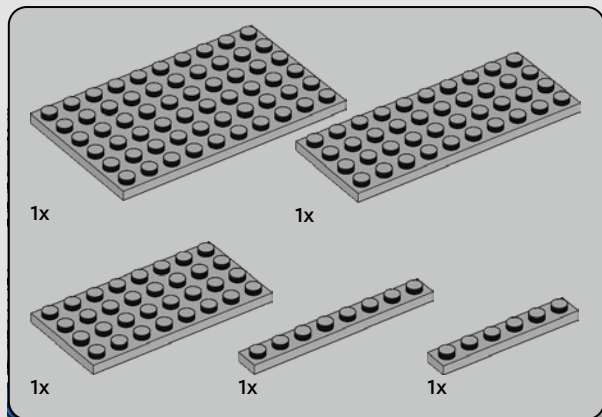

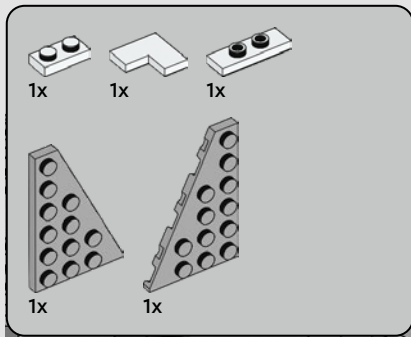

546



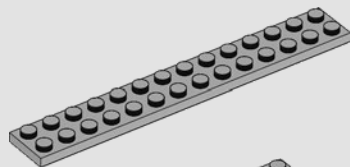
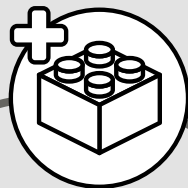
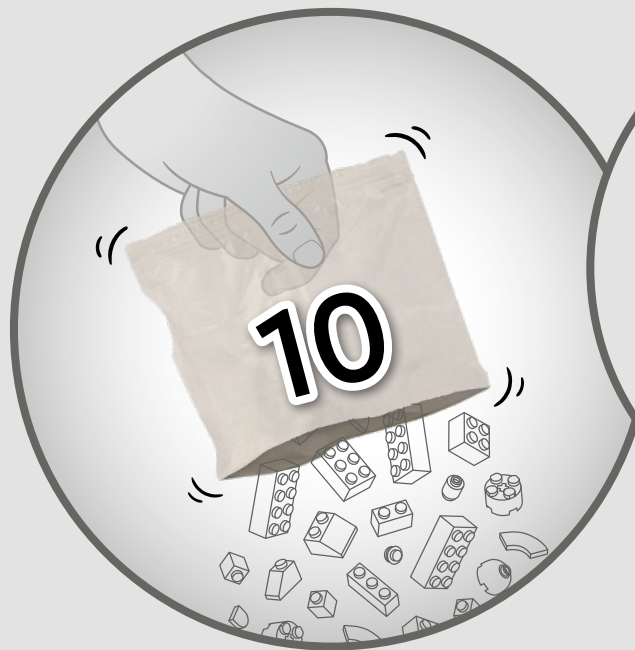

1x

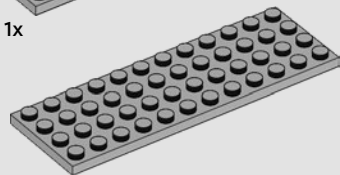

1x

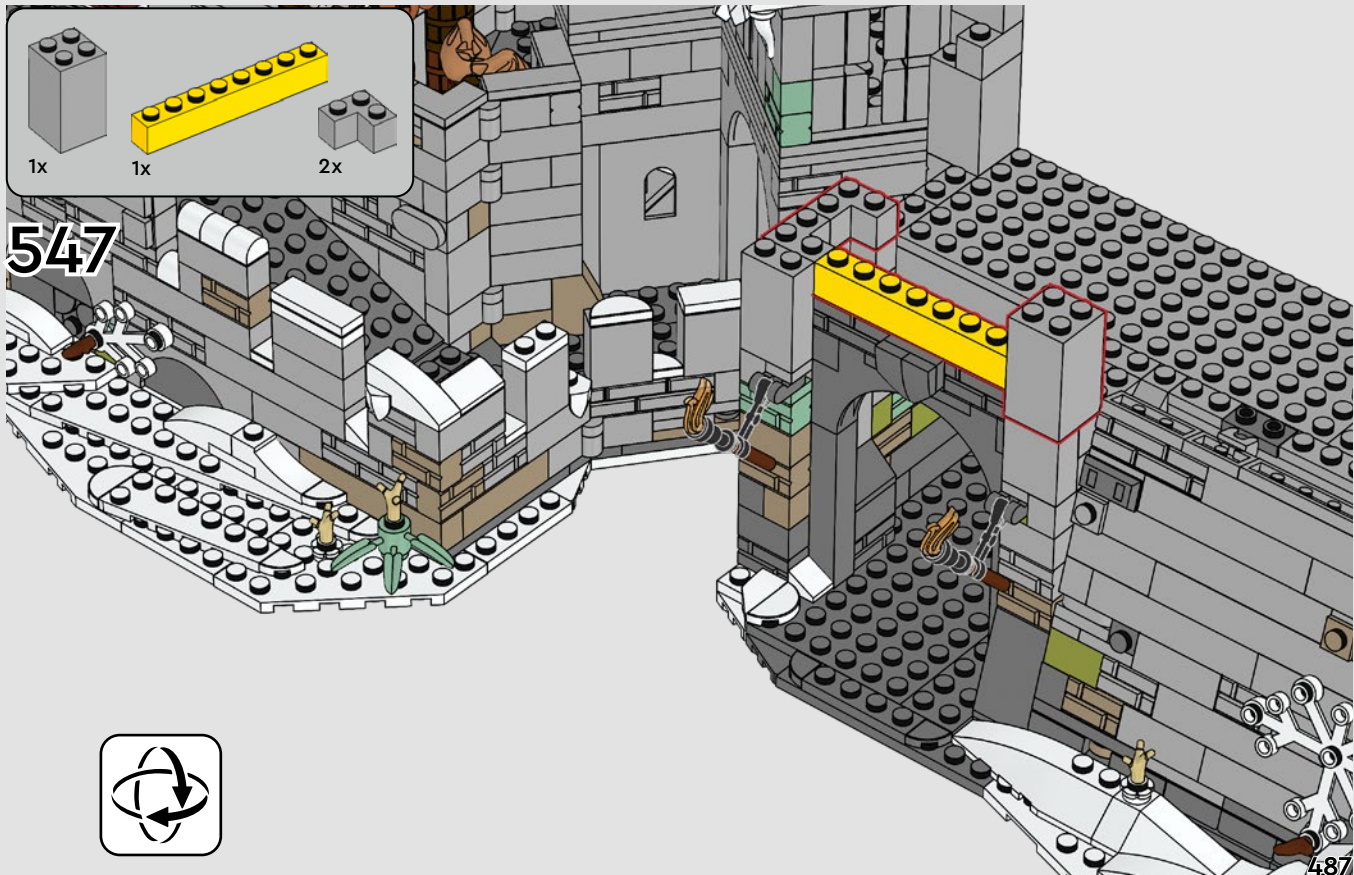

1x

1x

2x

547



487

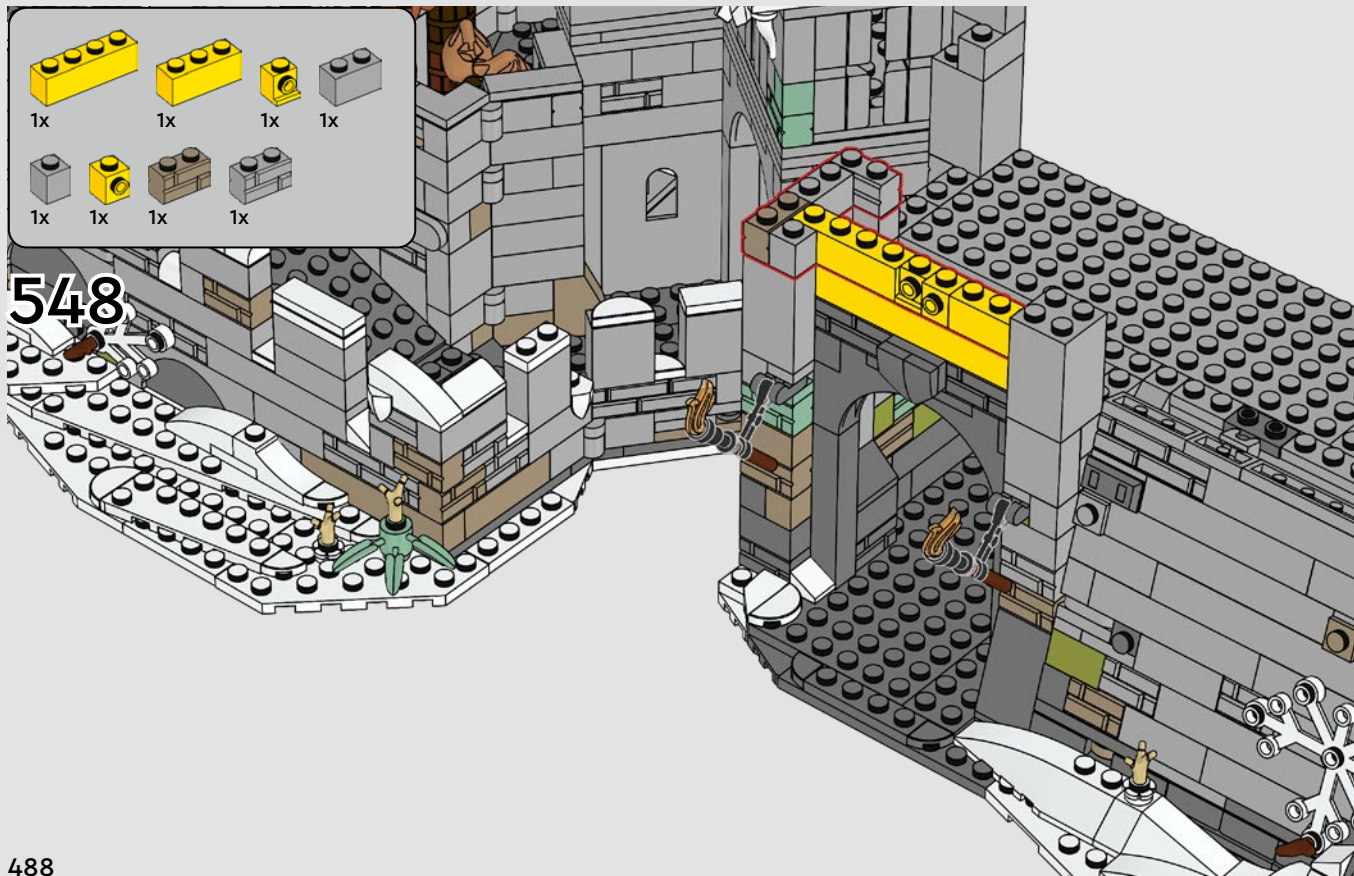



1x



1x



1x

549

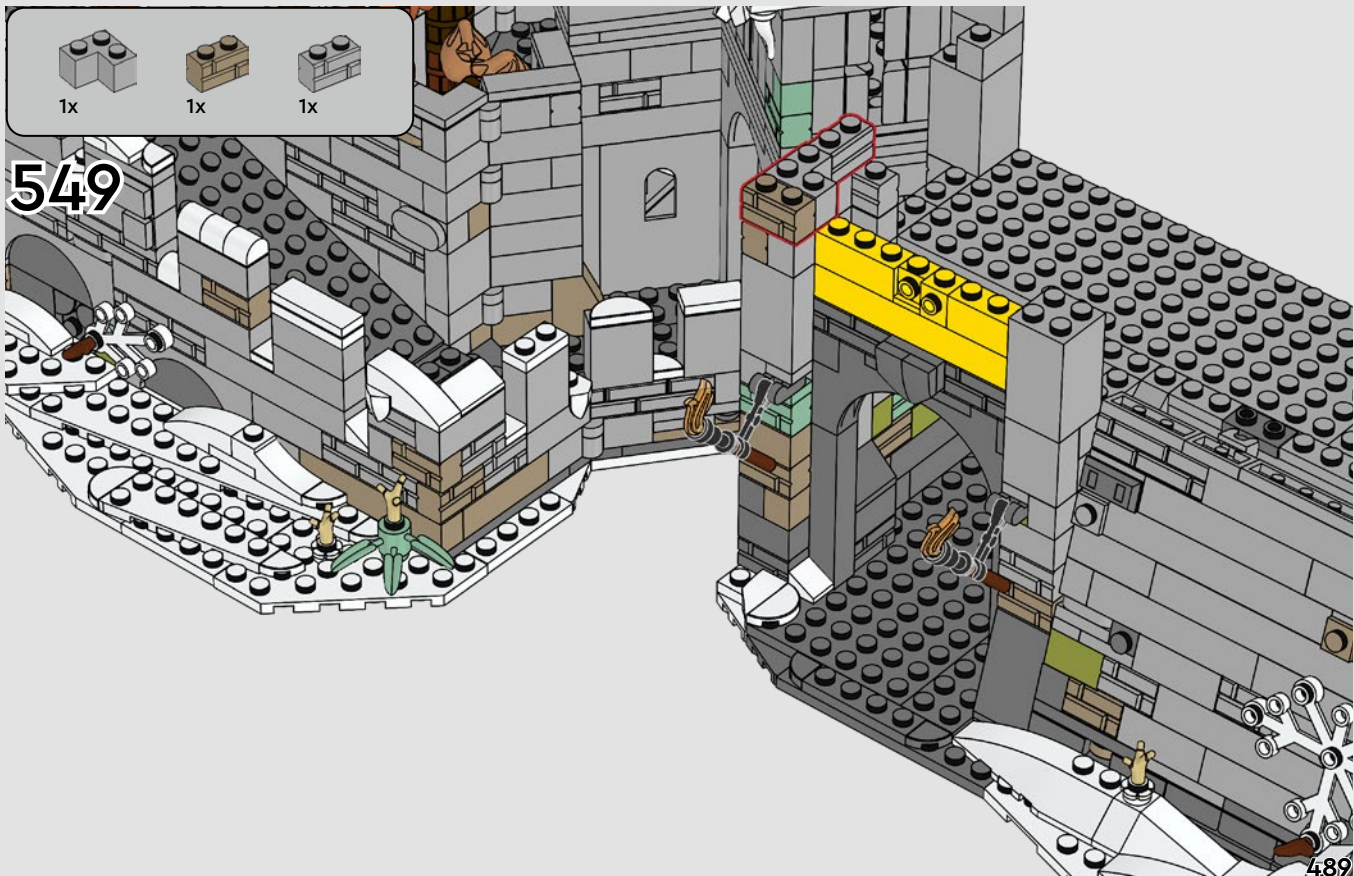



2x

550

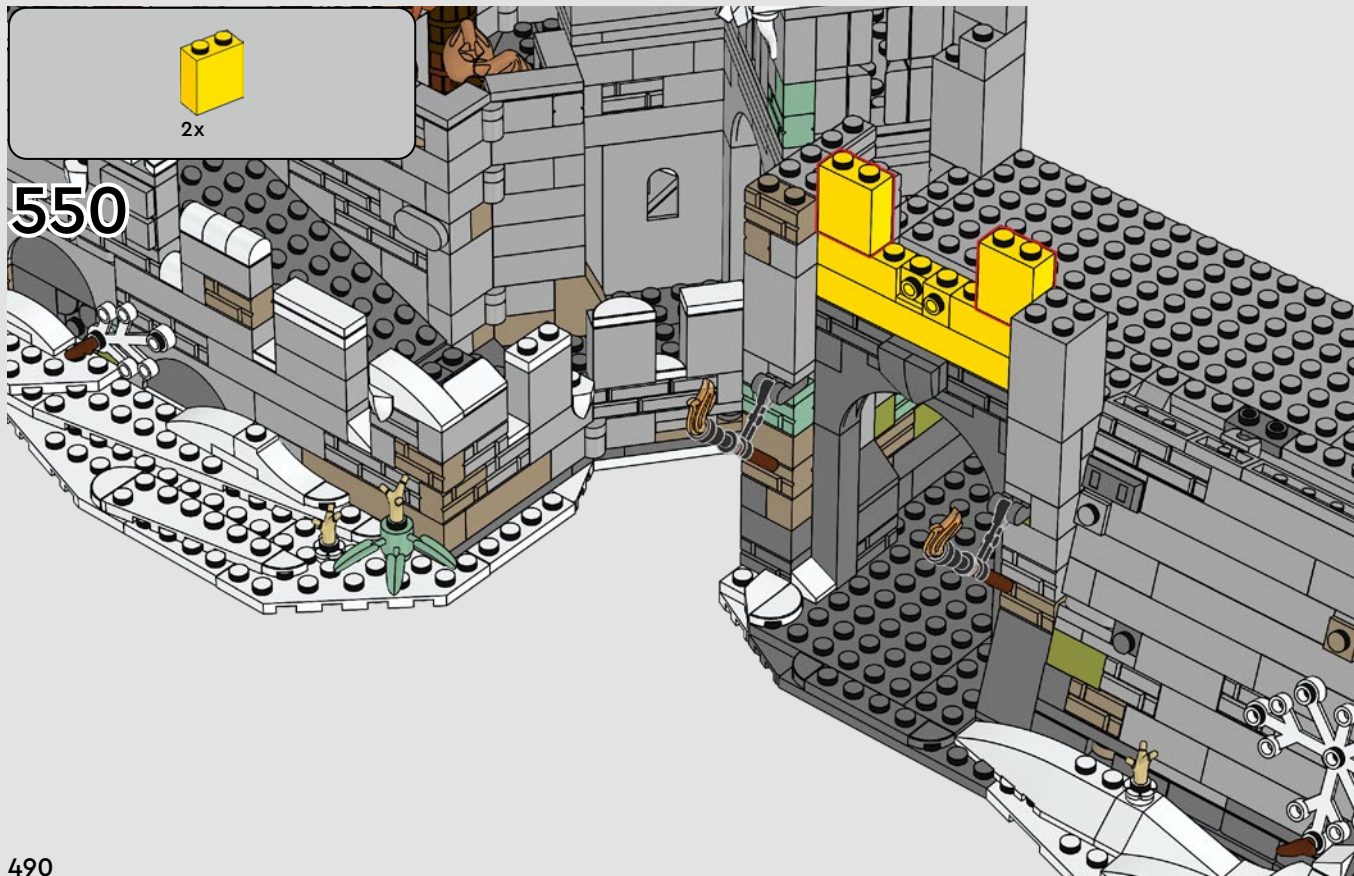



3x



2x



1x

551

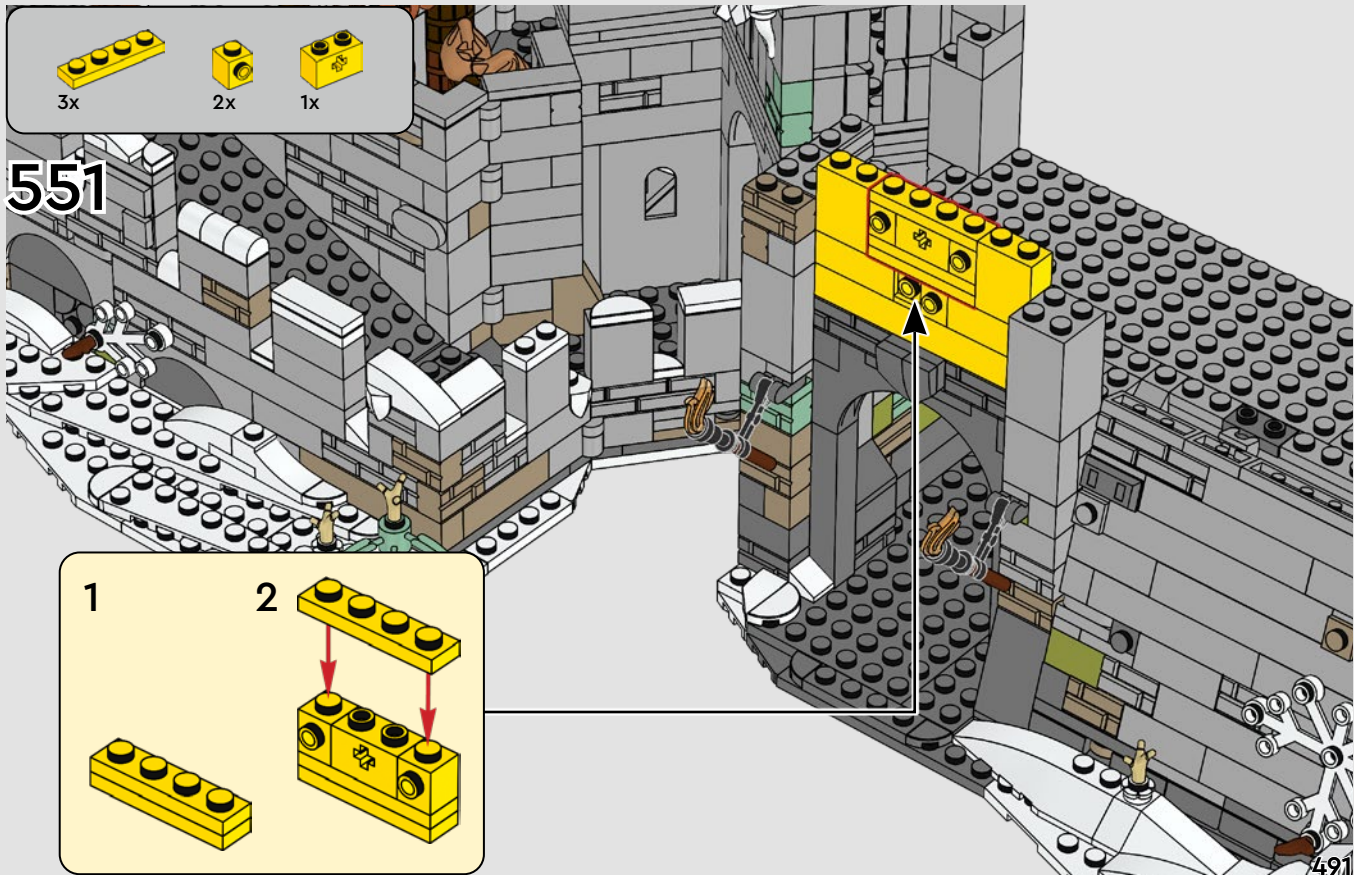

1

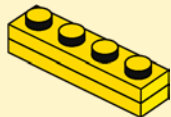

2

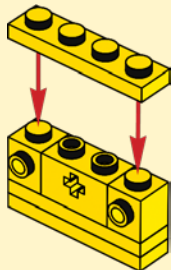

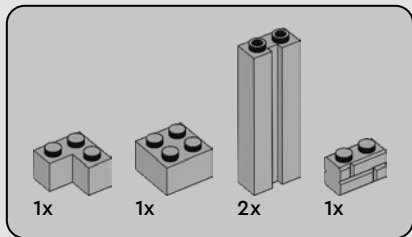

552

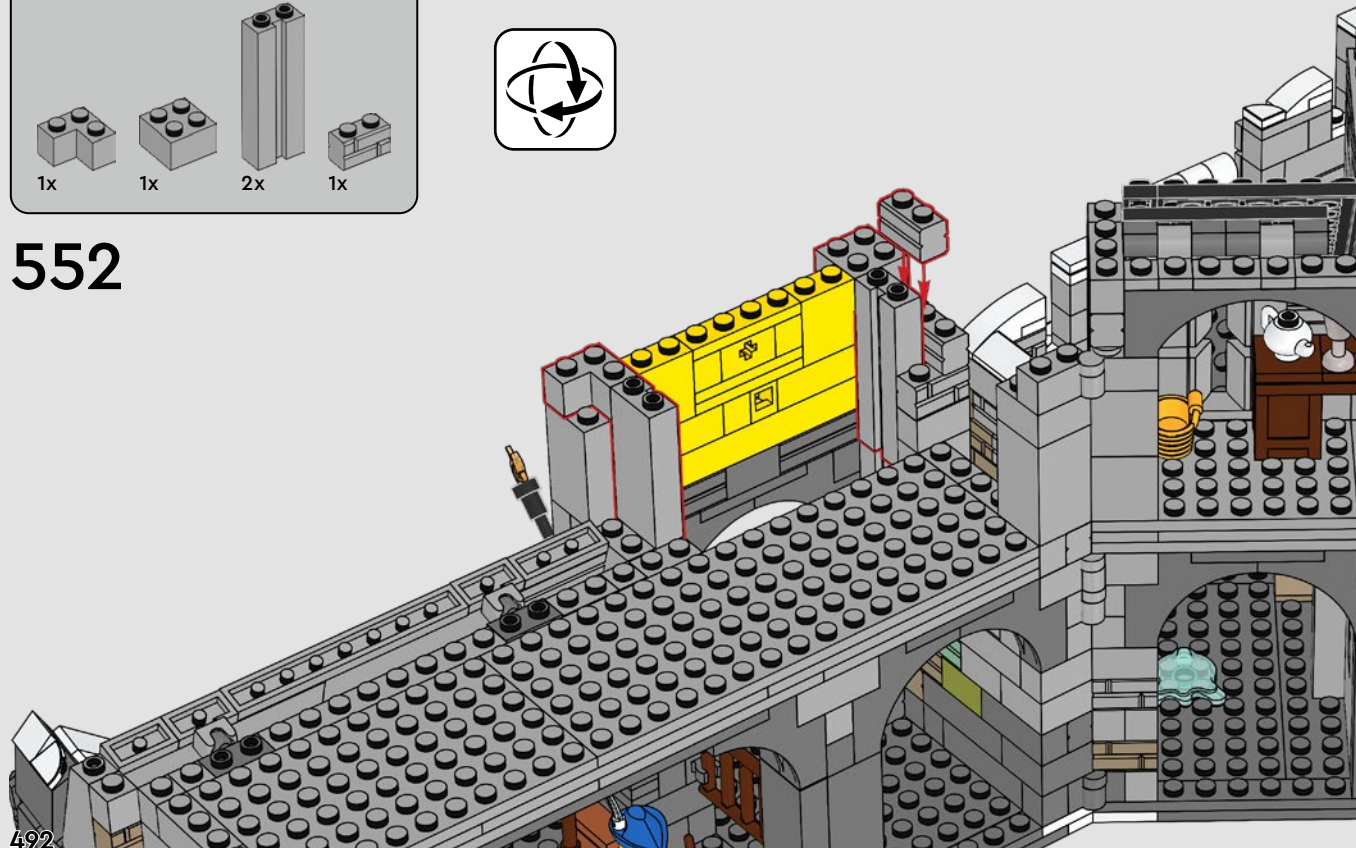

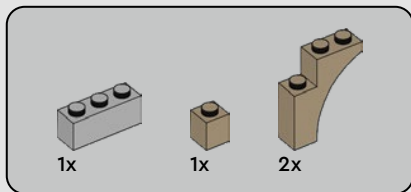

553

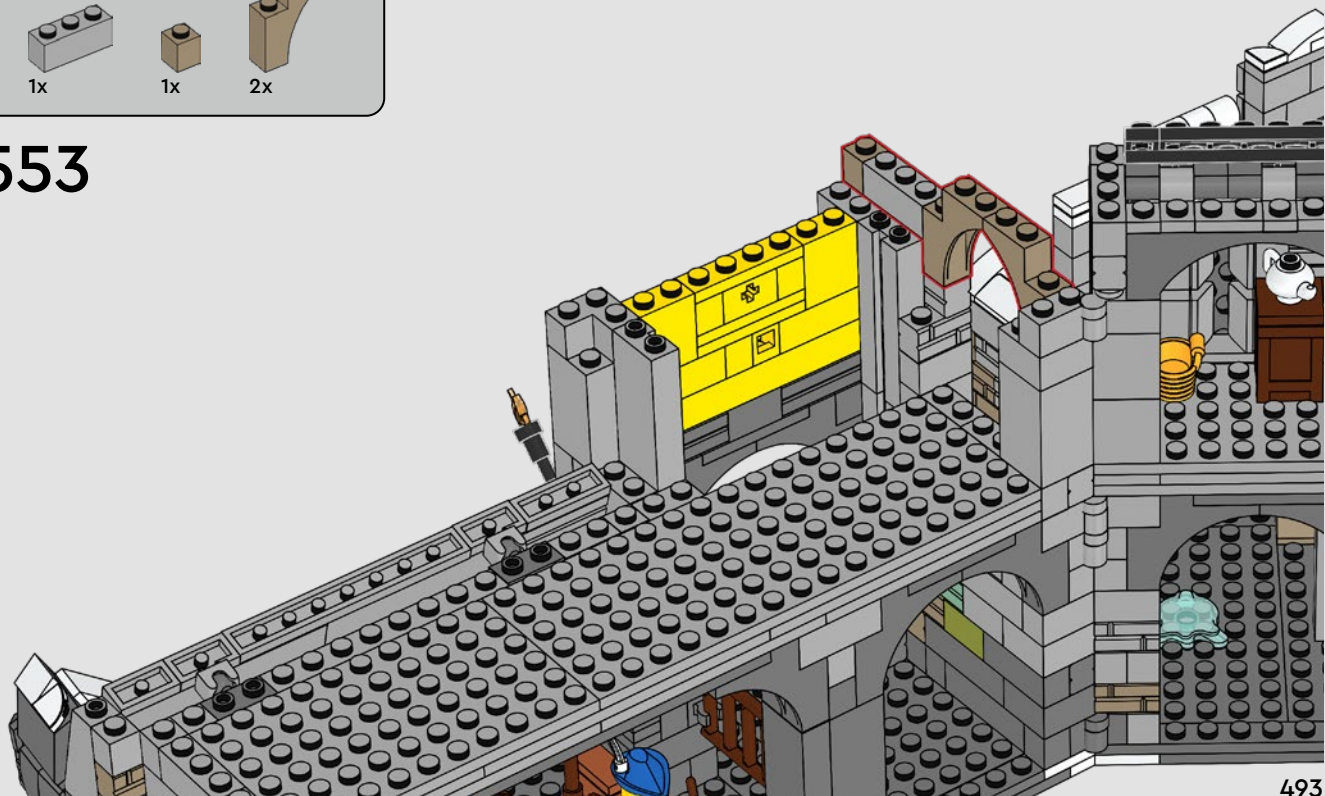

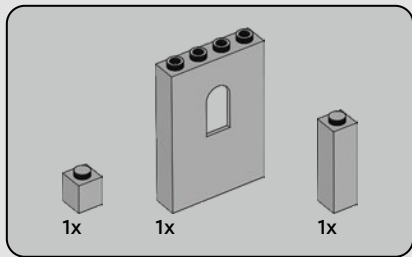

554

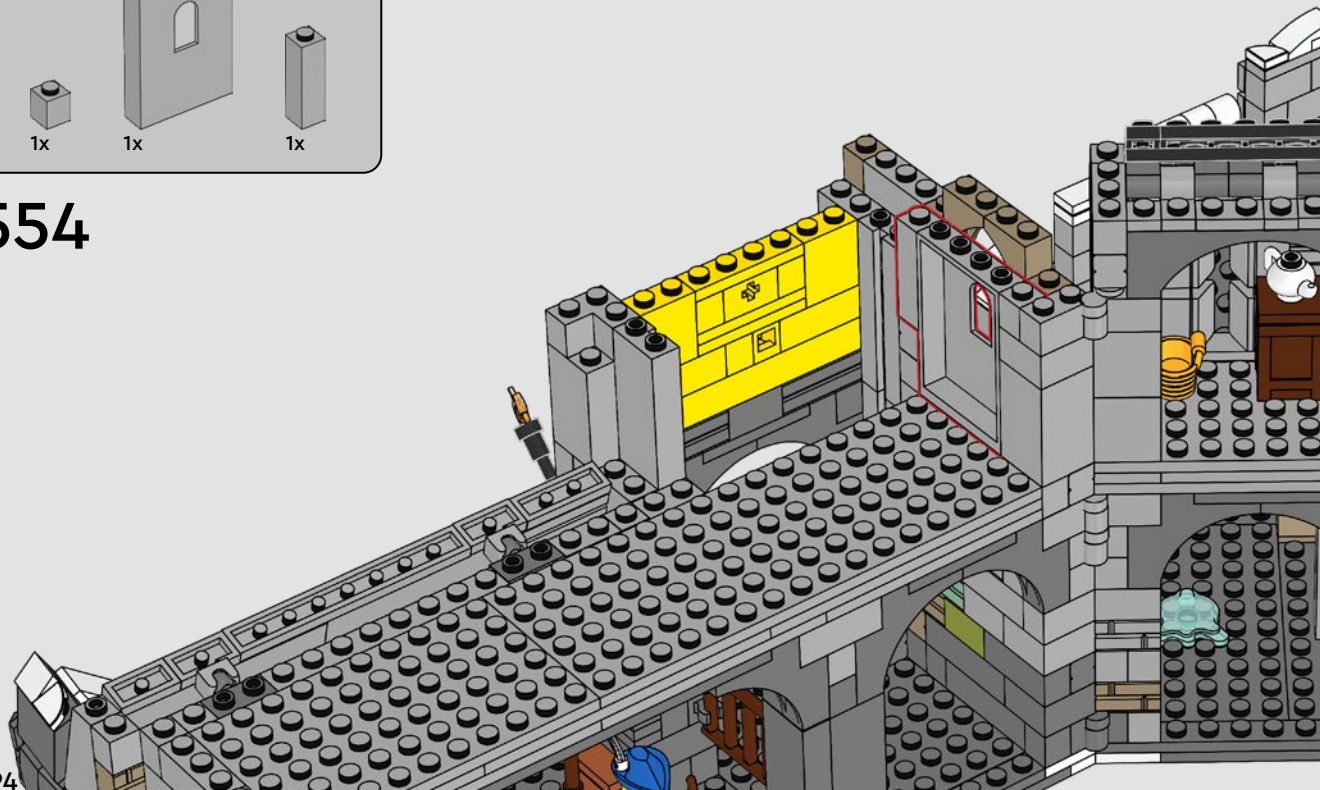

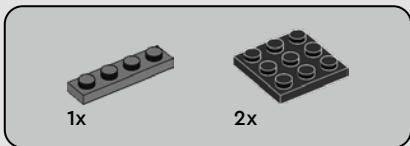
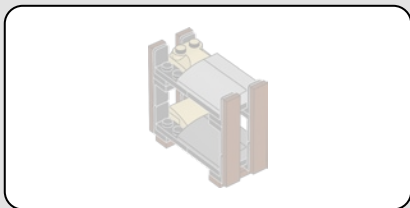

555

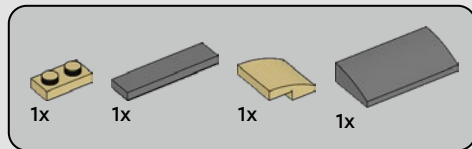
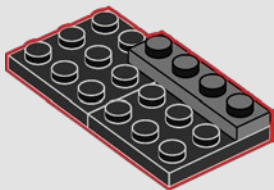

556

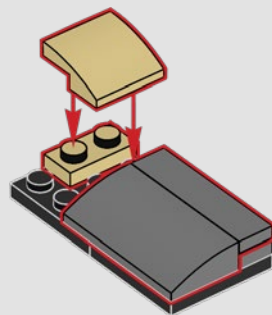



4x



557

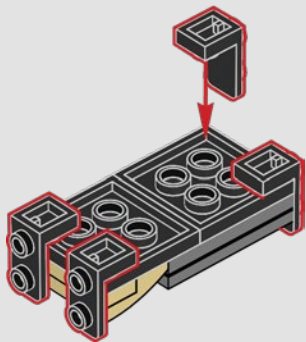

2x

558

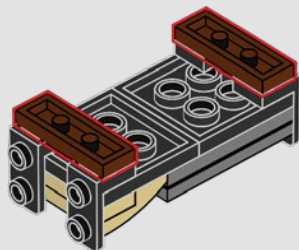

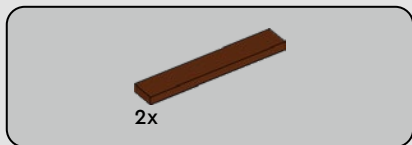

559

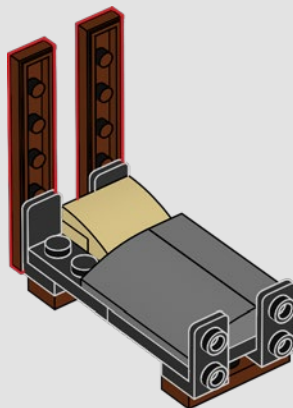

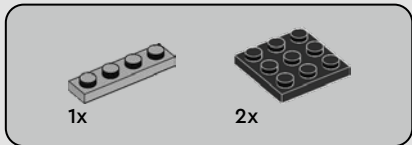
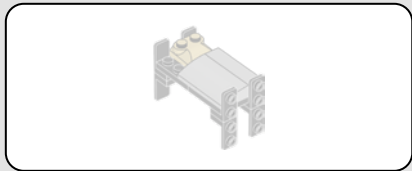

560

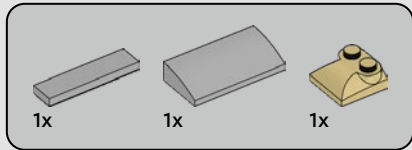
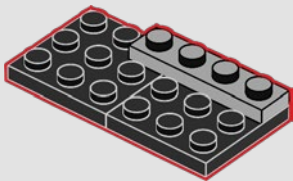

561

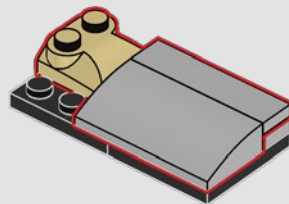



4x



562

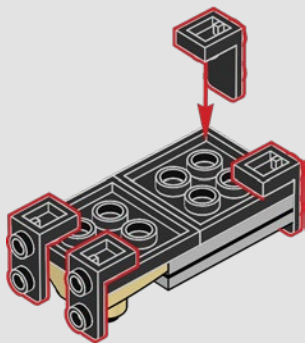

4x

563

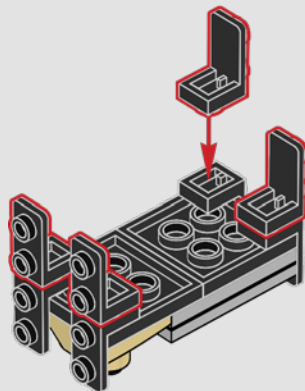

564

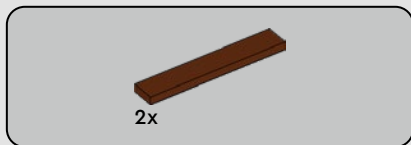
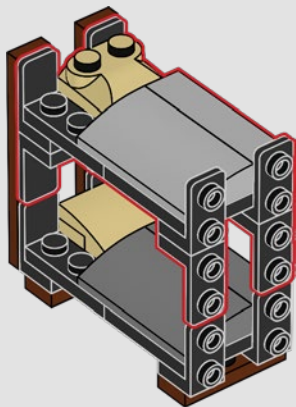
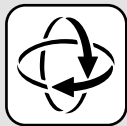

565

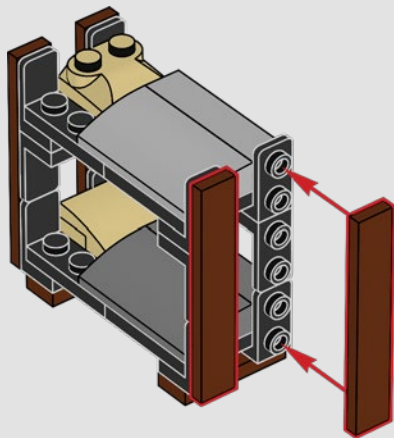

566

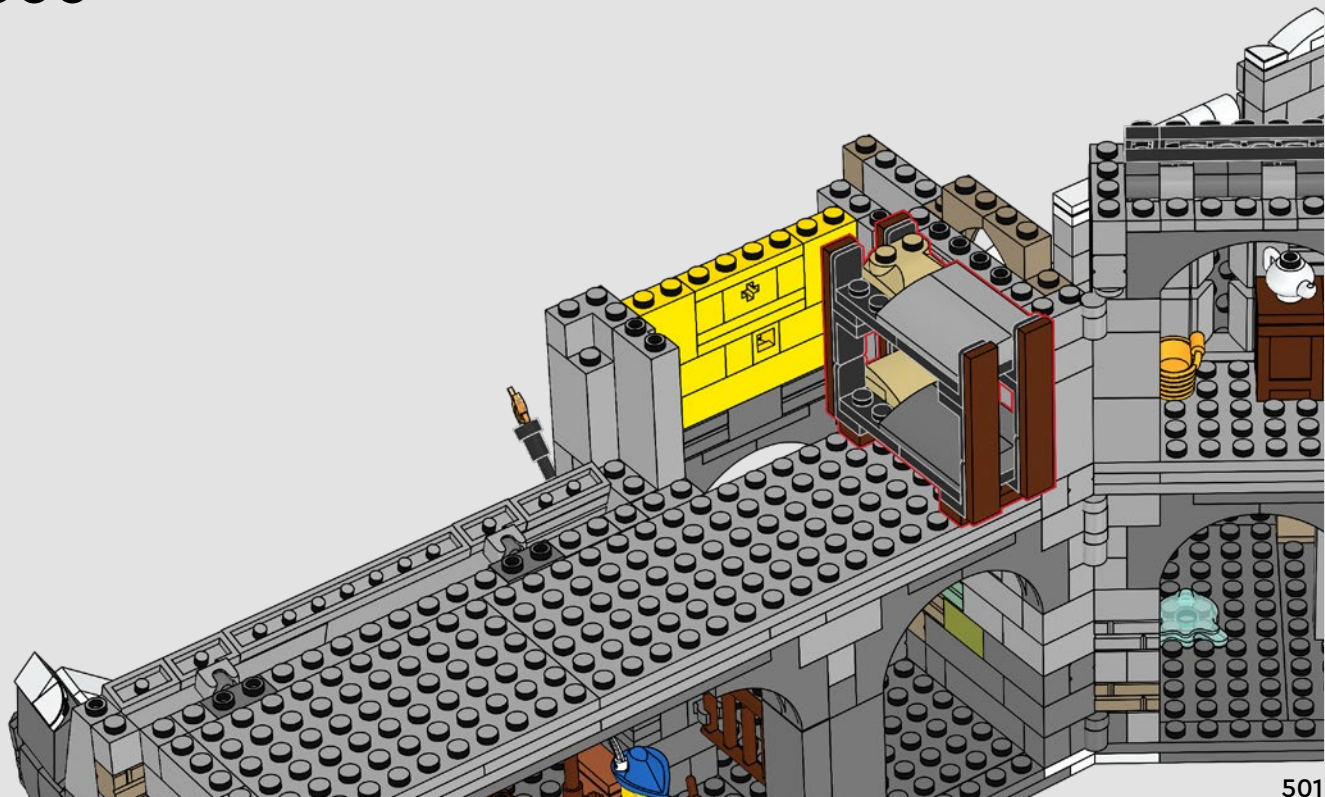

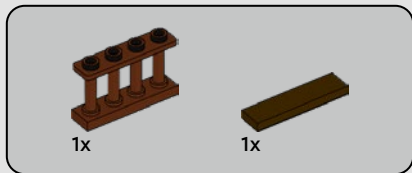

567

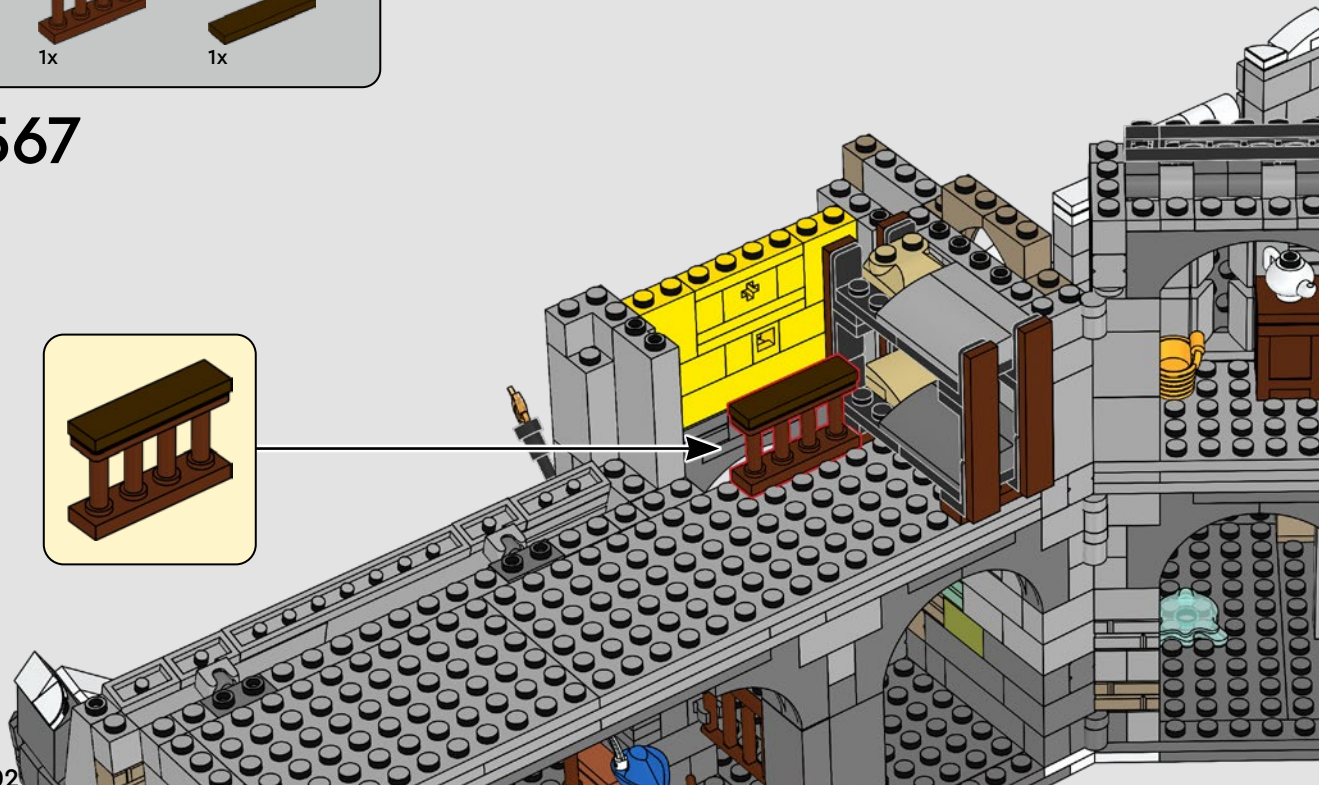

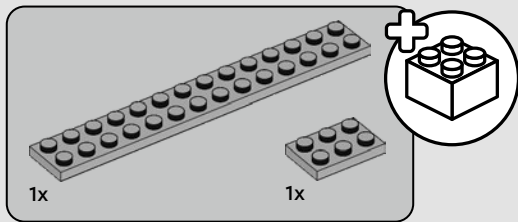

568

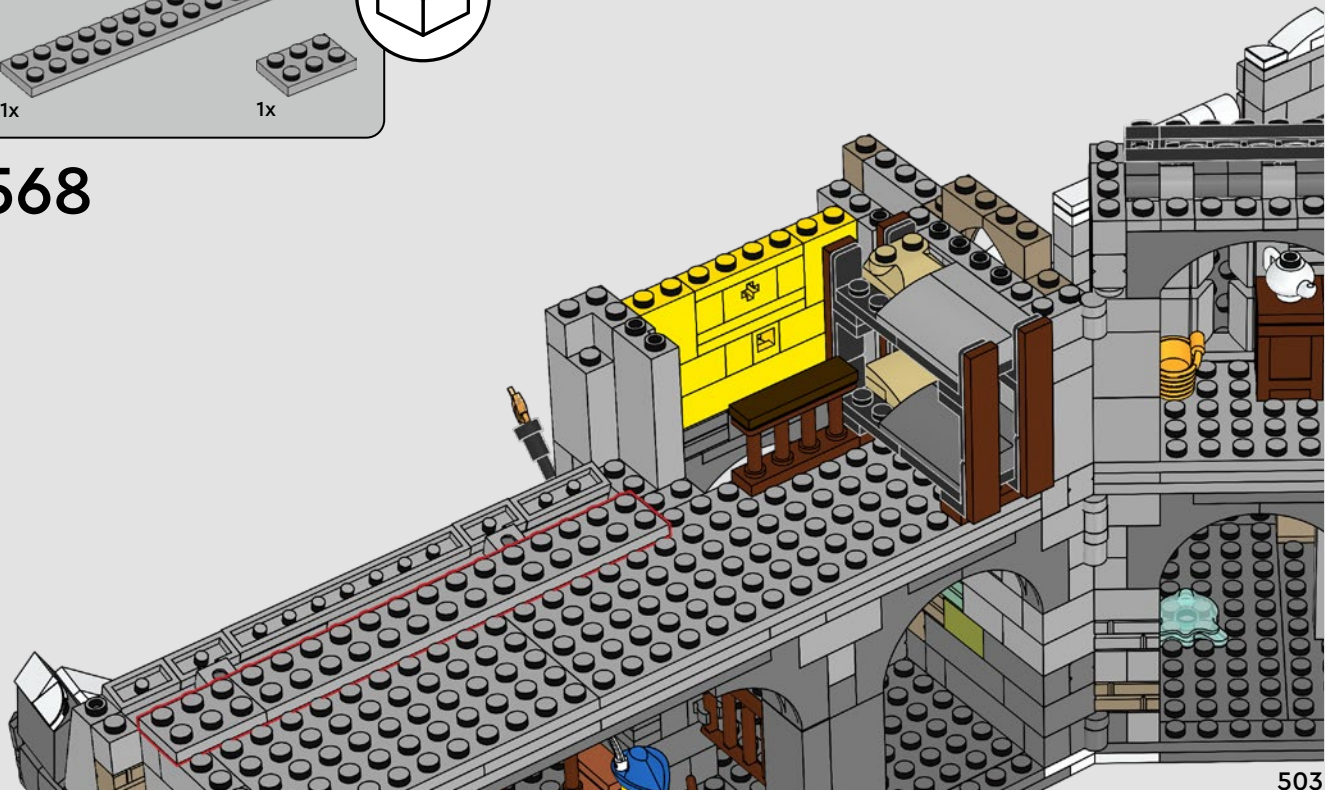

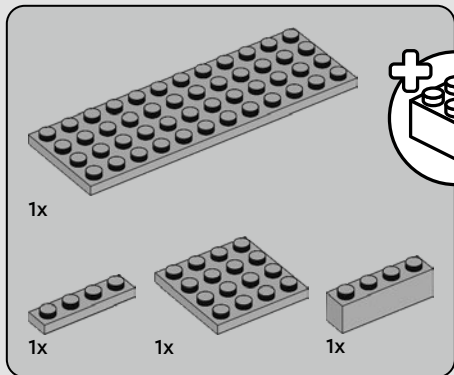

569

504

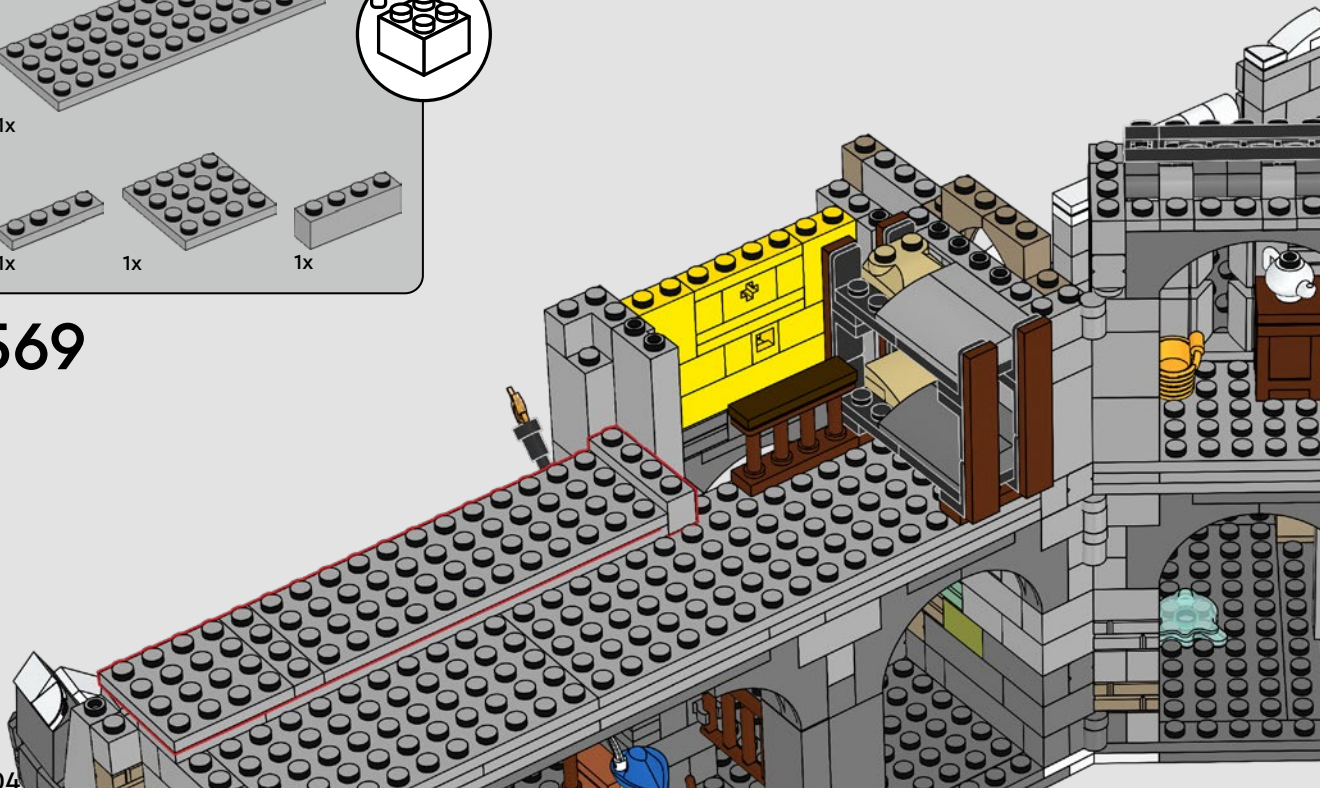

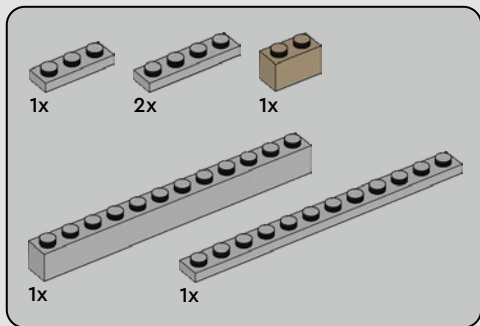

570

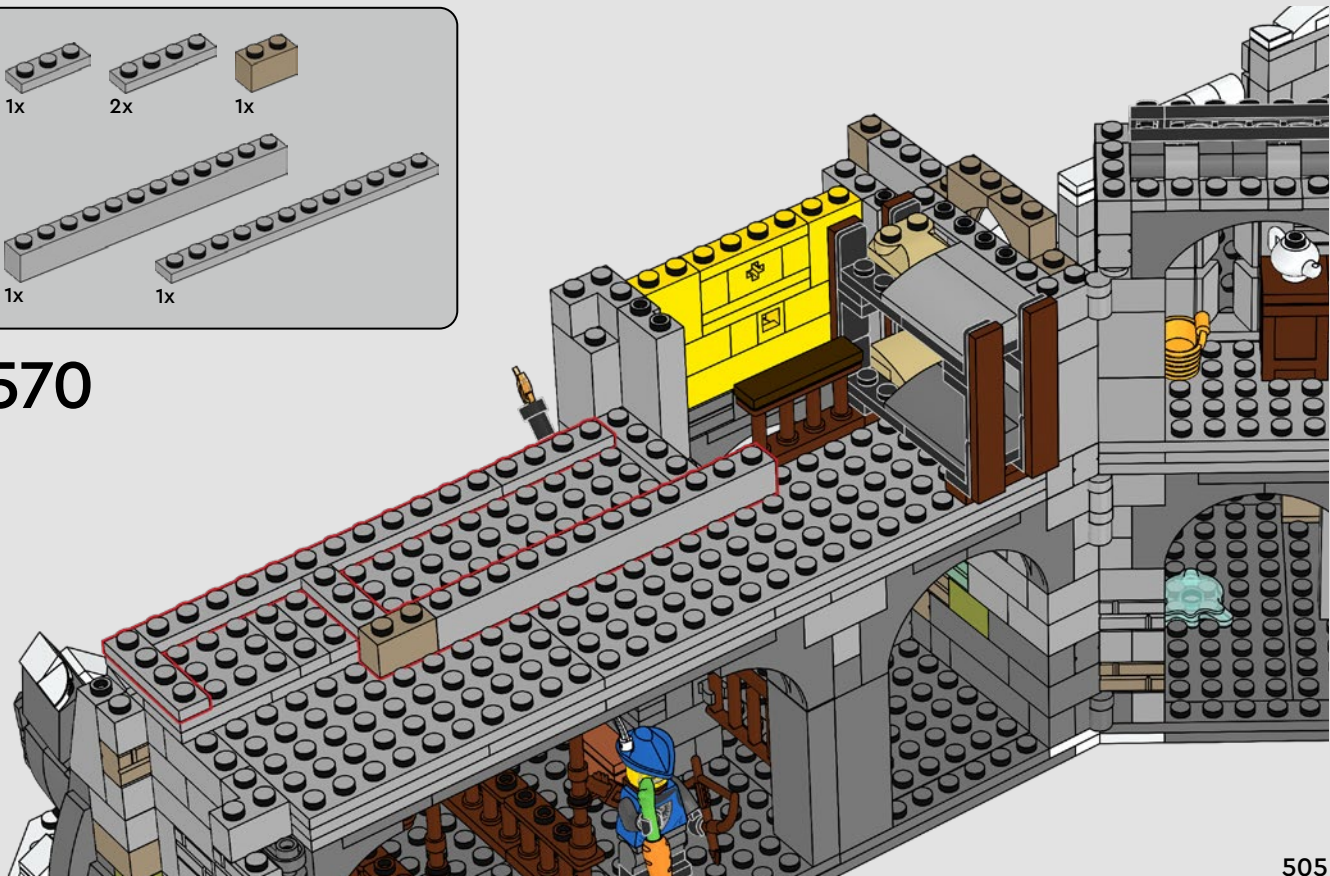

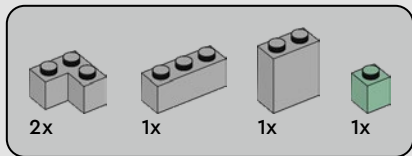

571

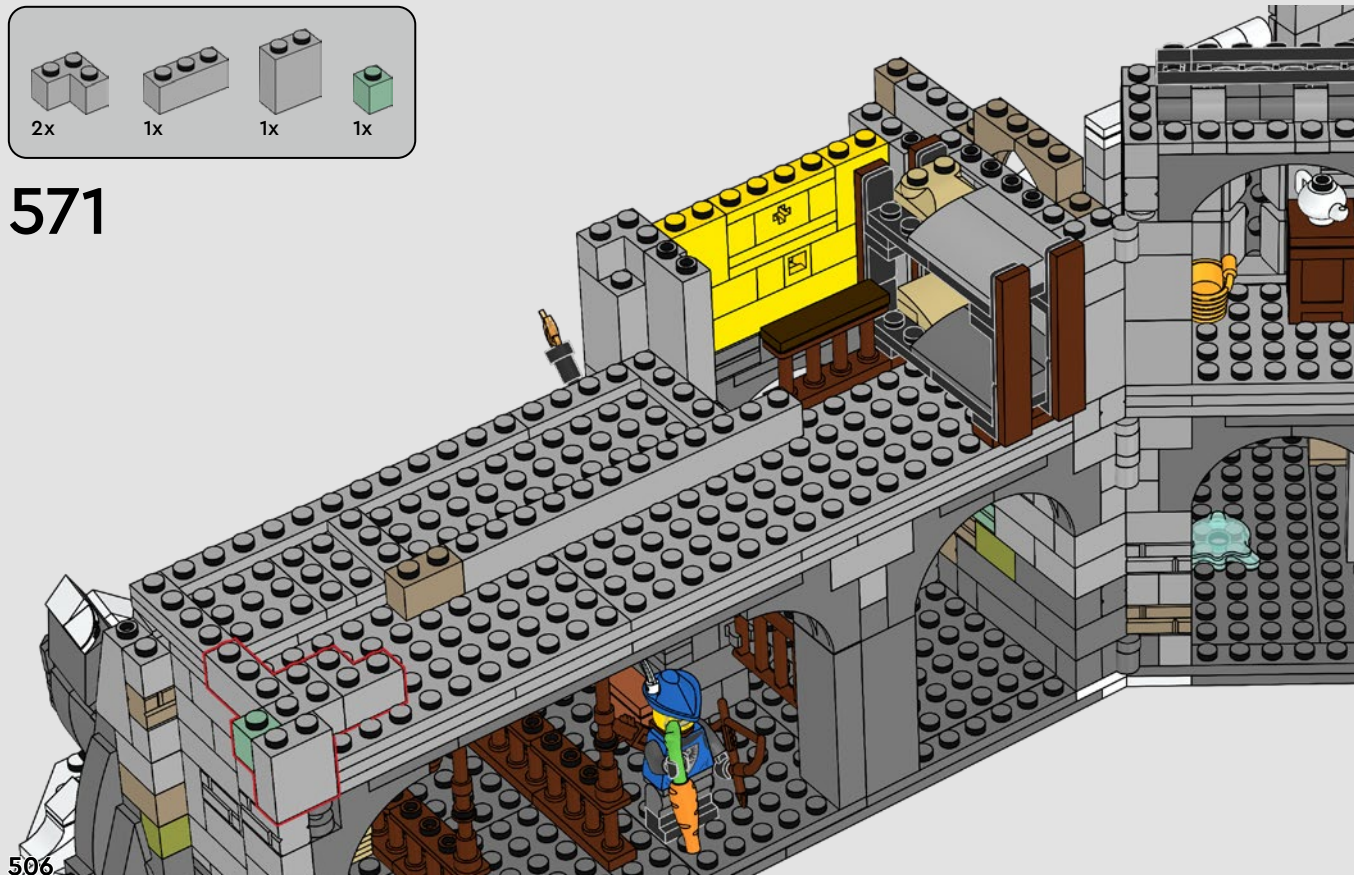

506

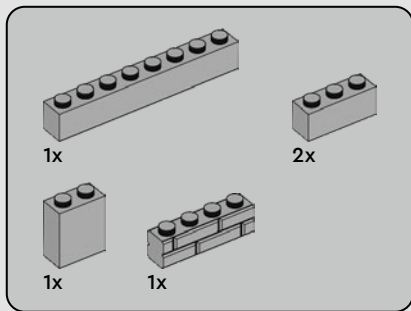

572

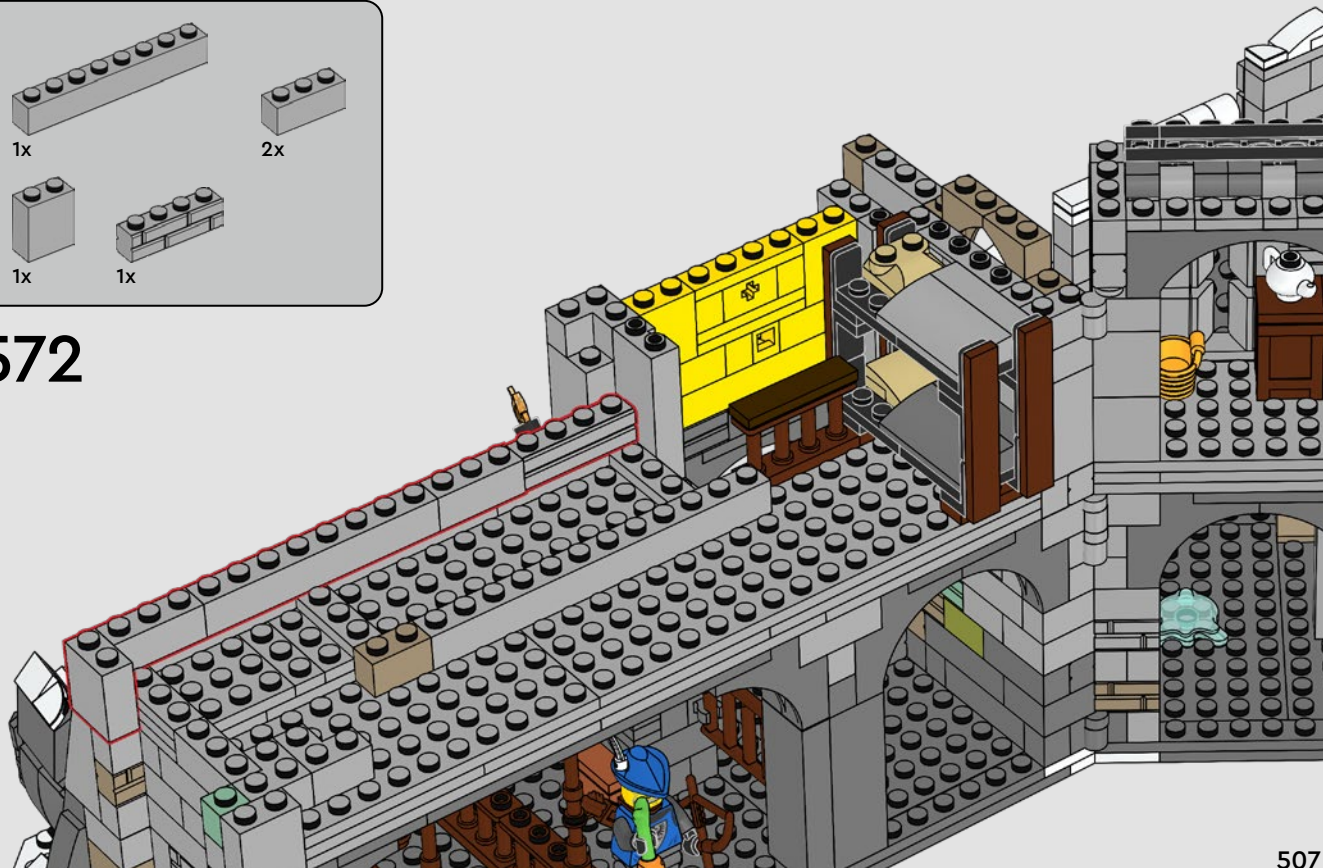



2x



1x

573

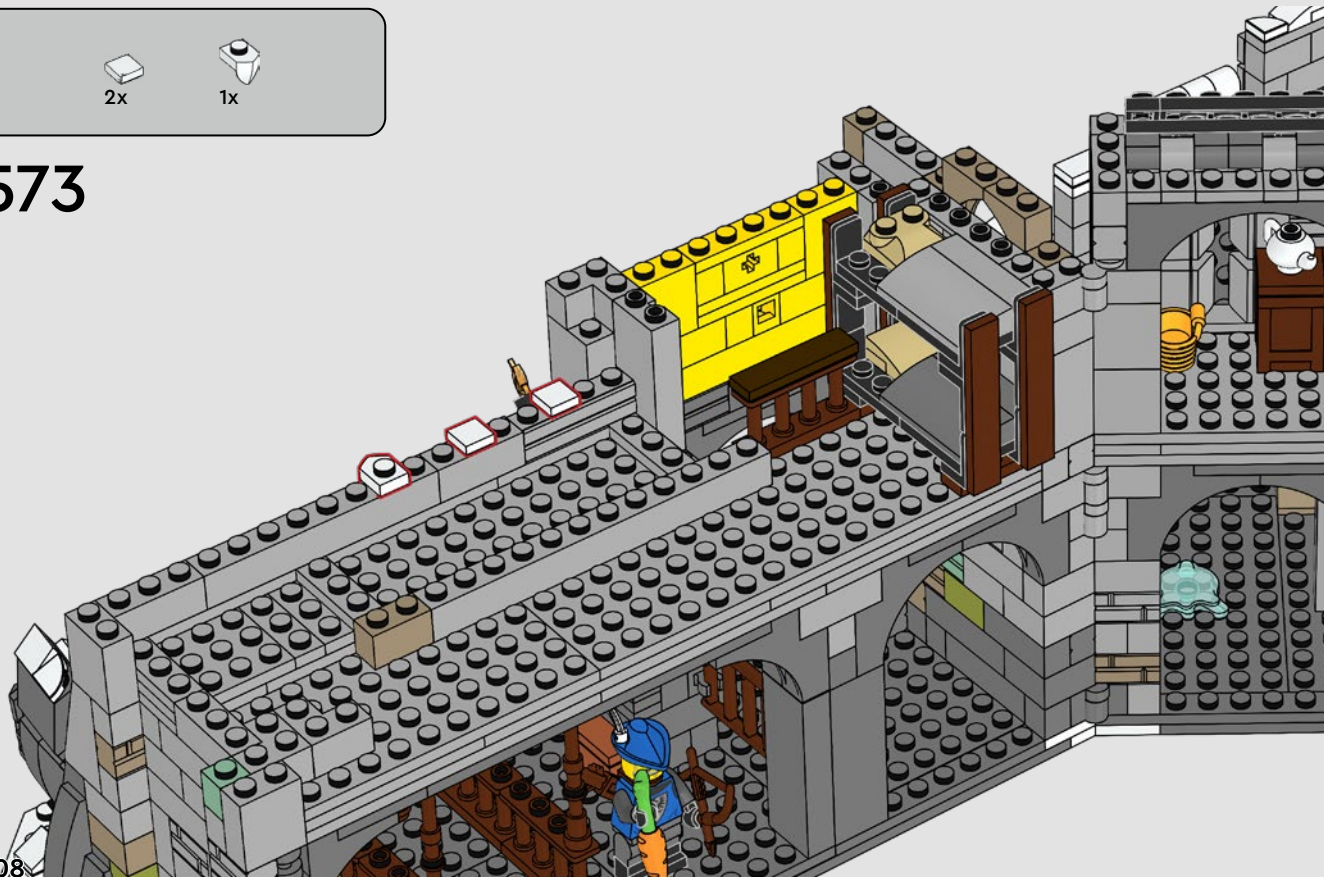

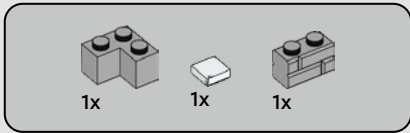

574

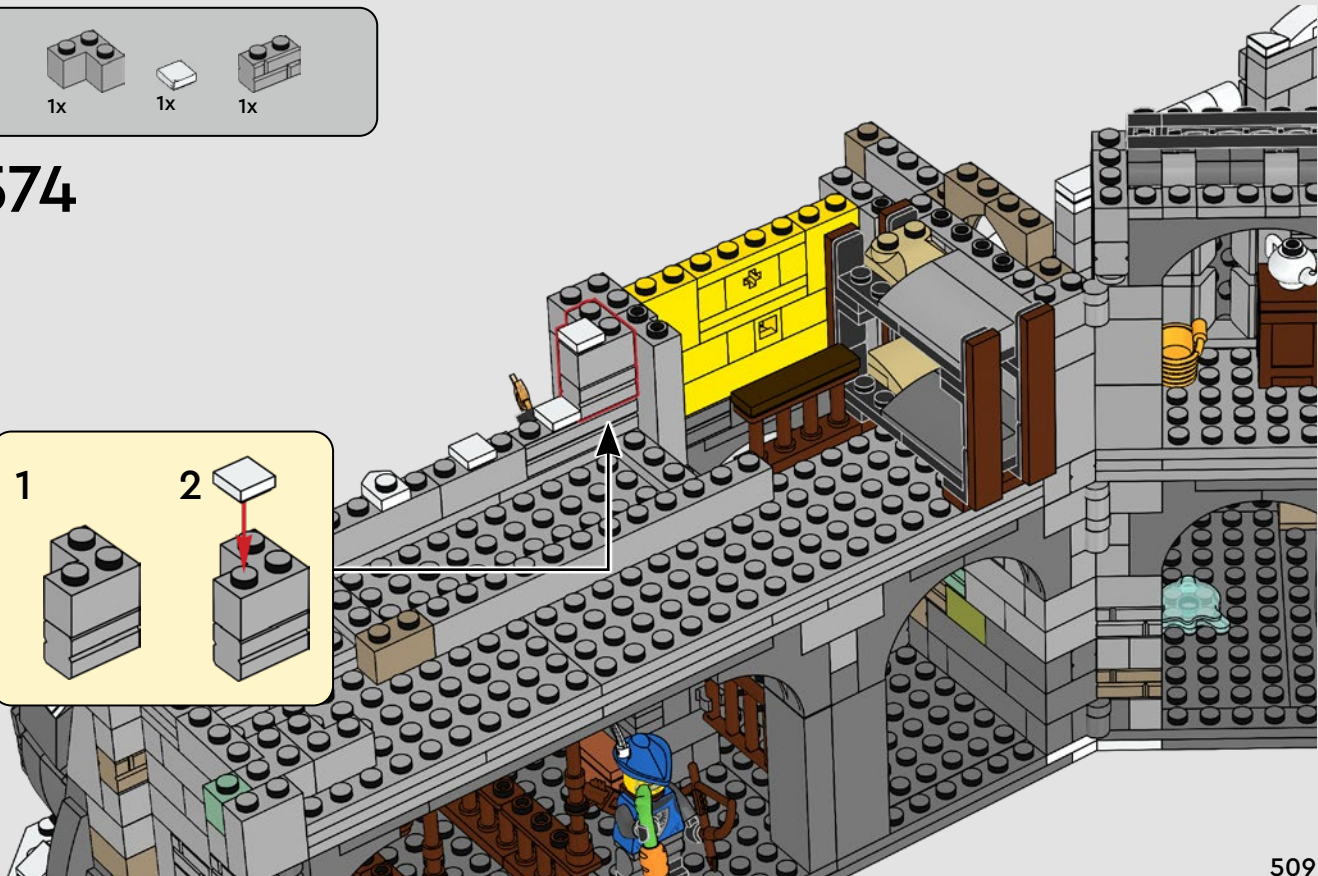
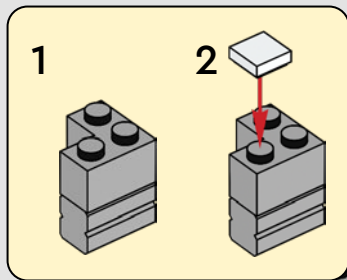

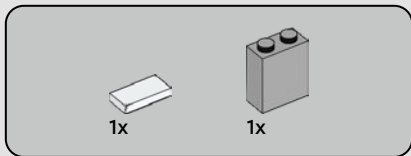

575

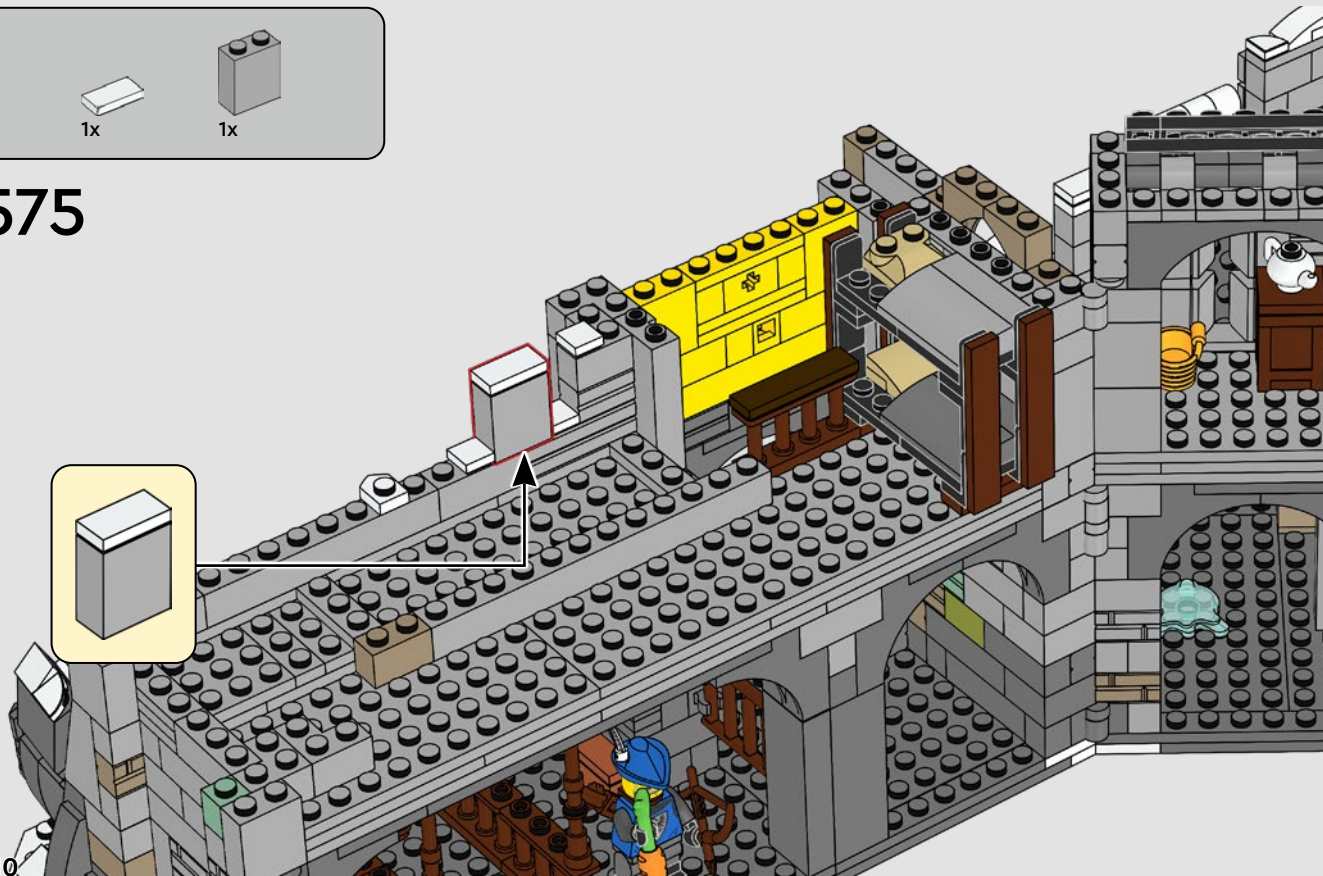
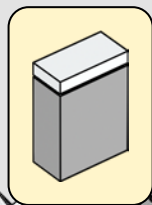

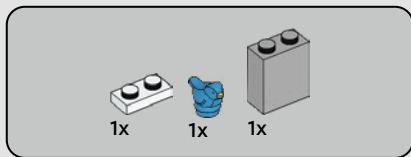

576

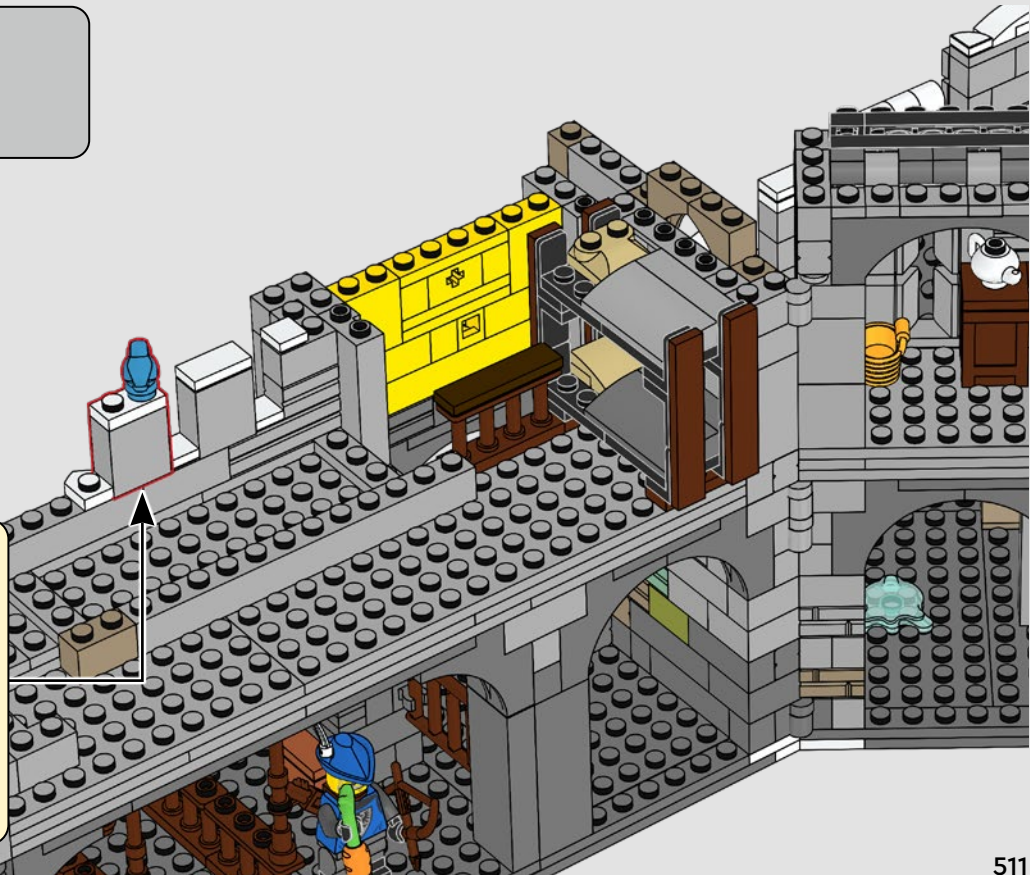
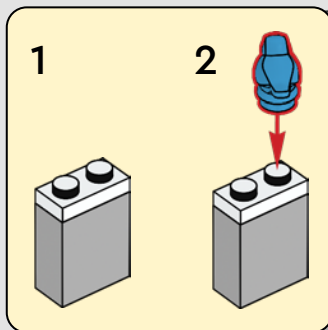

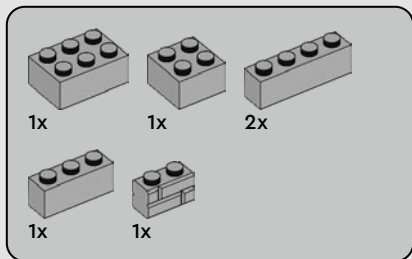

577

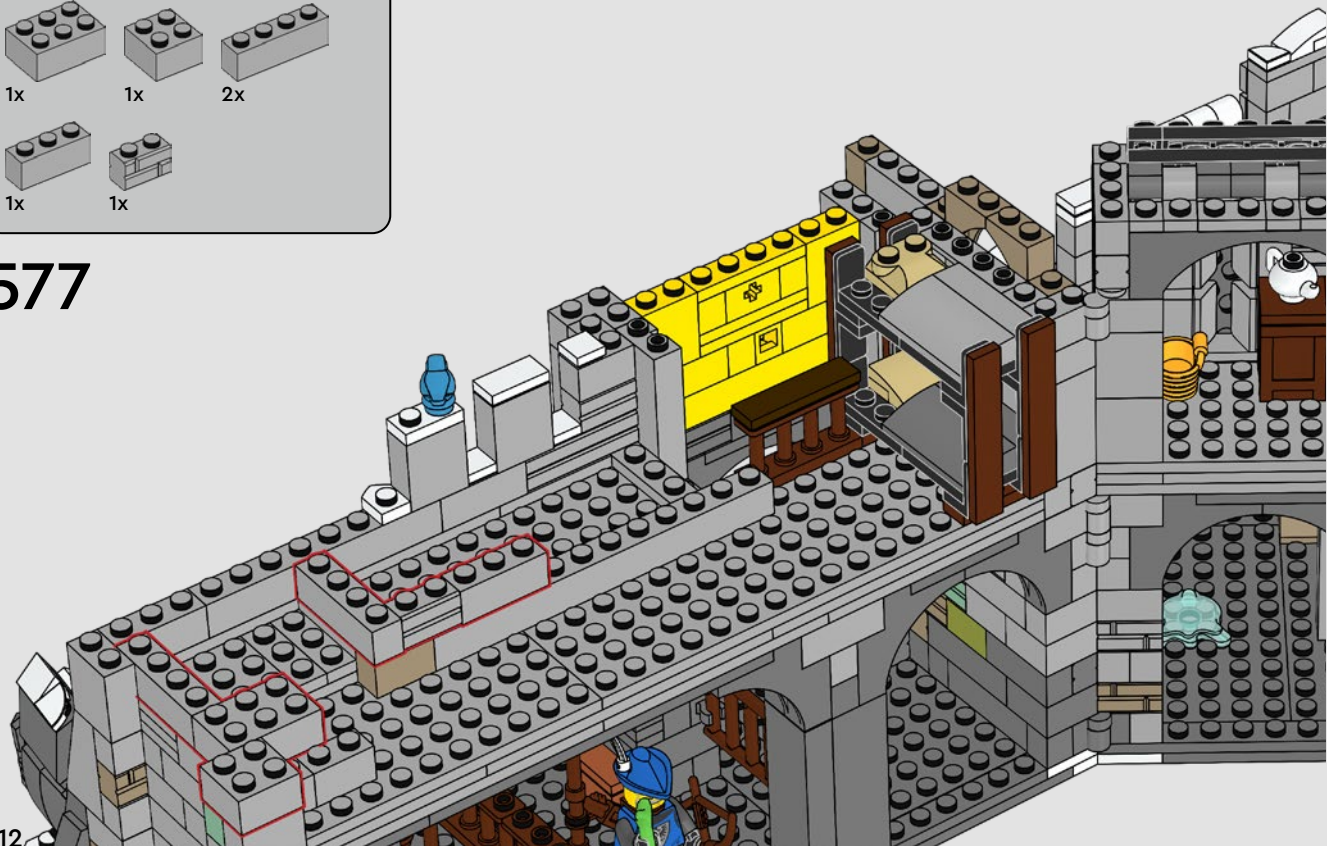

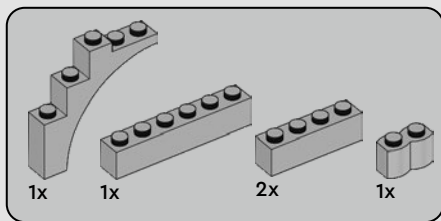

578

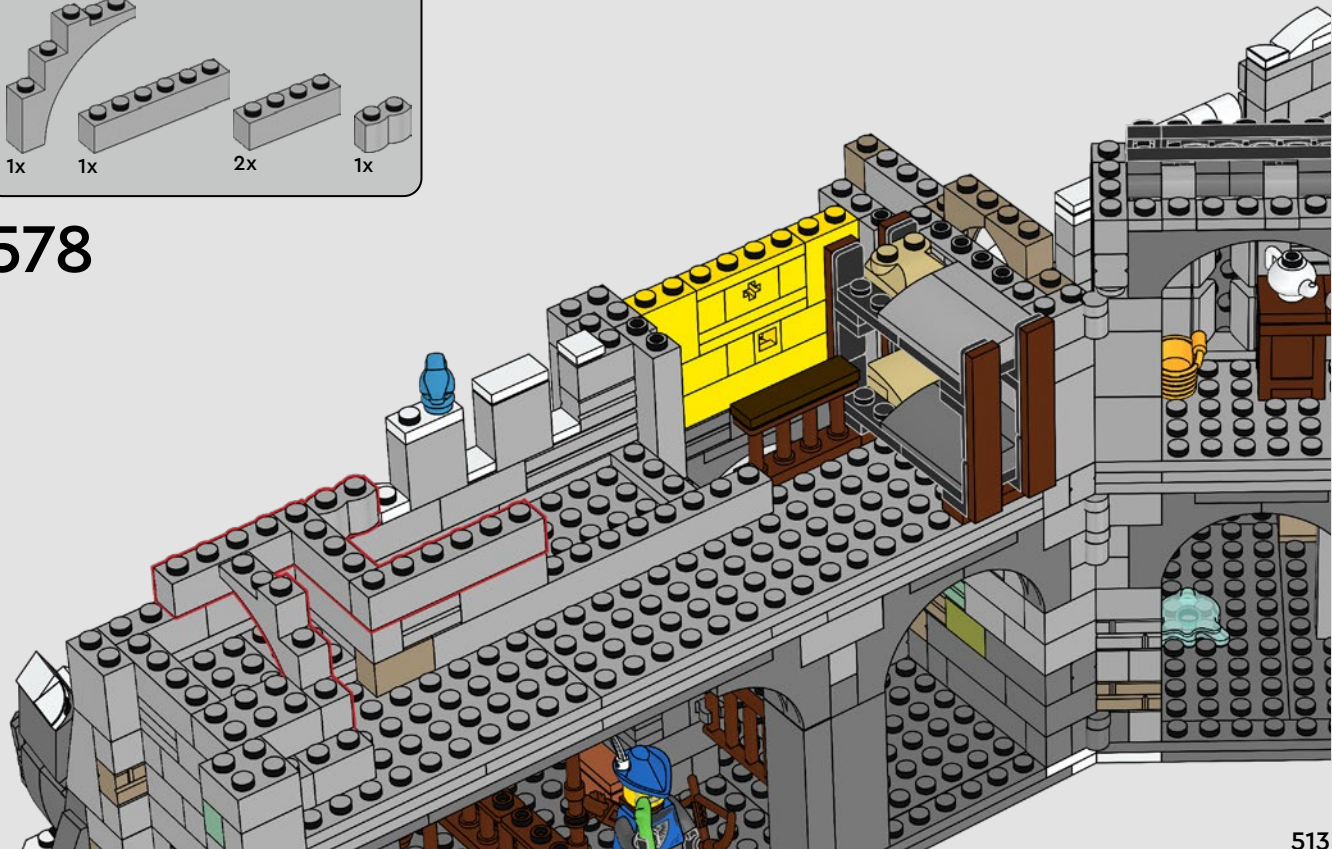

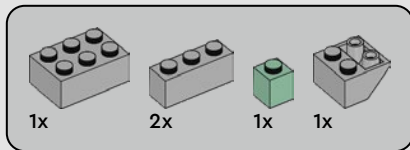

579

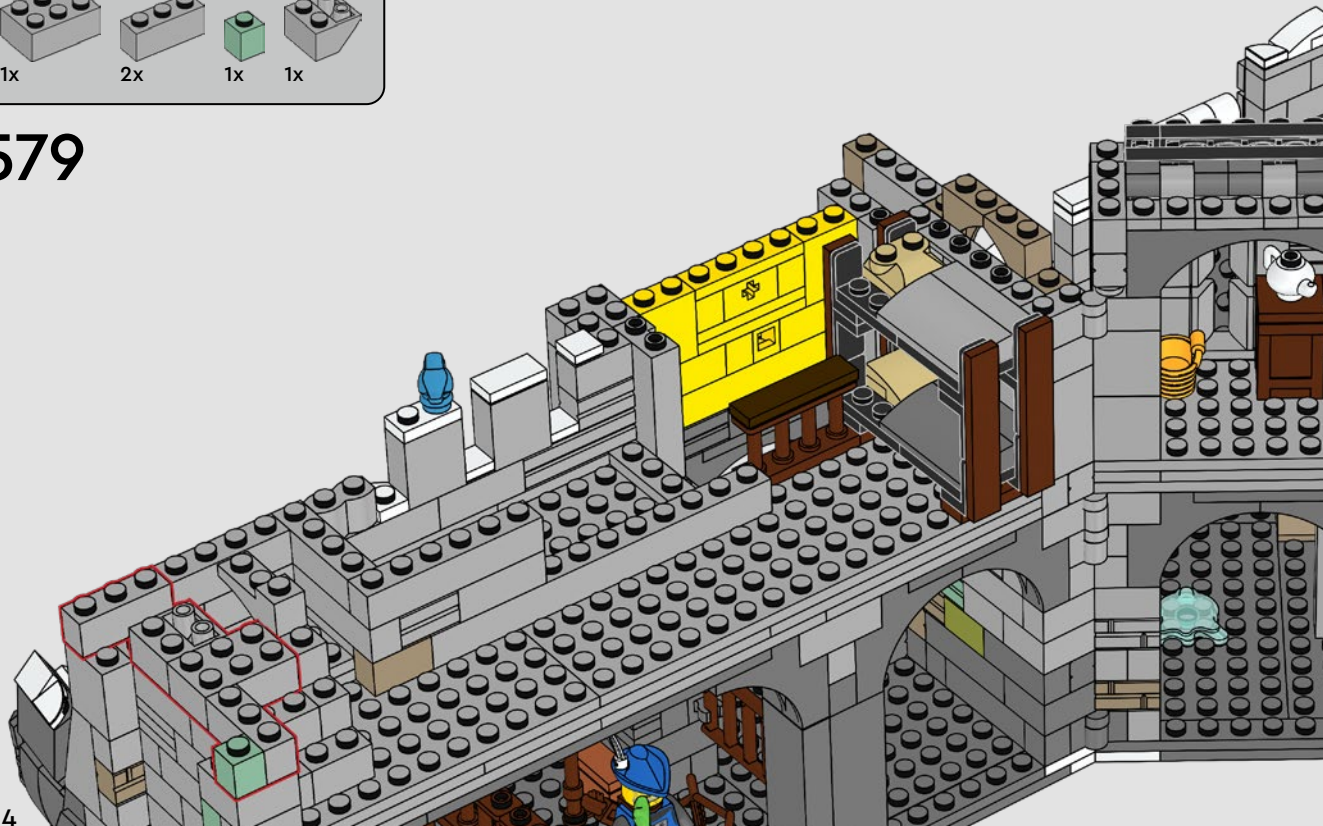

514



1x



1x

580

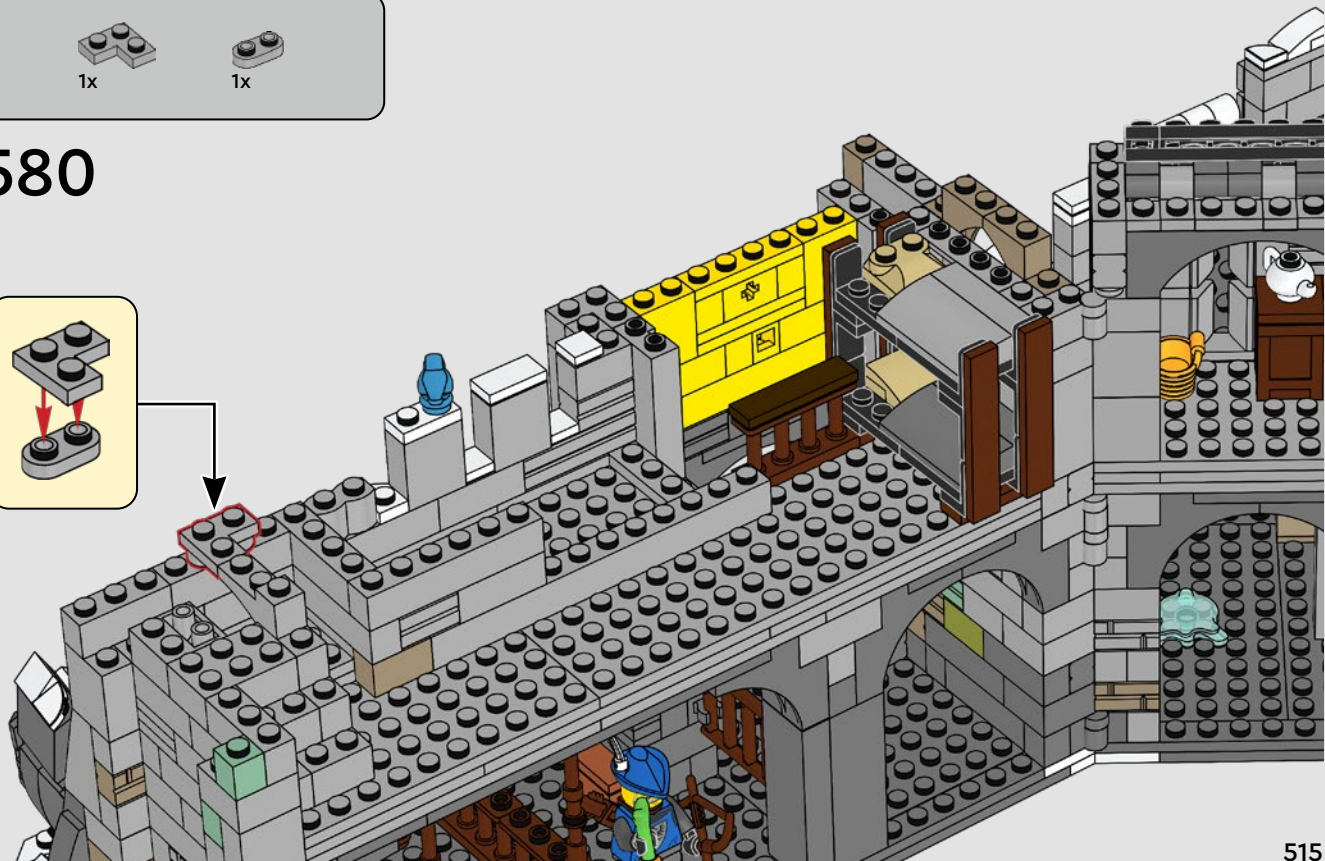
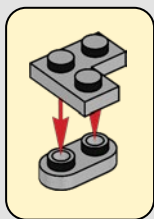

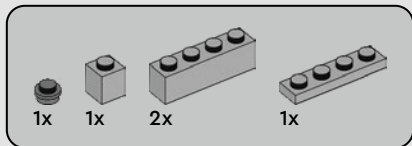

581

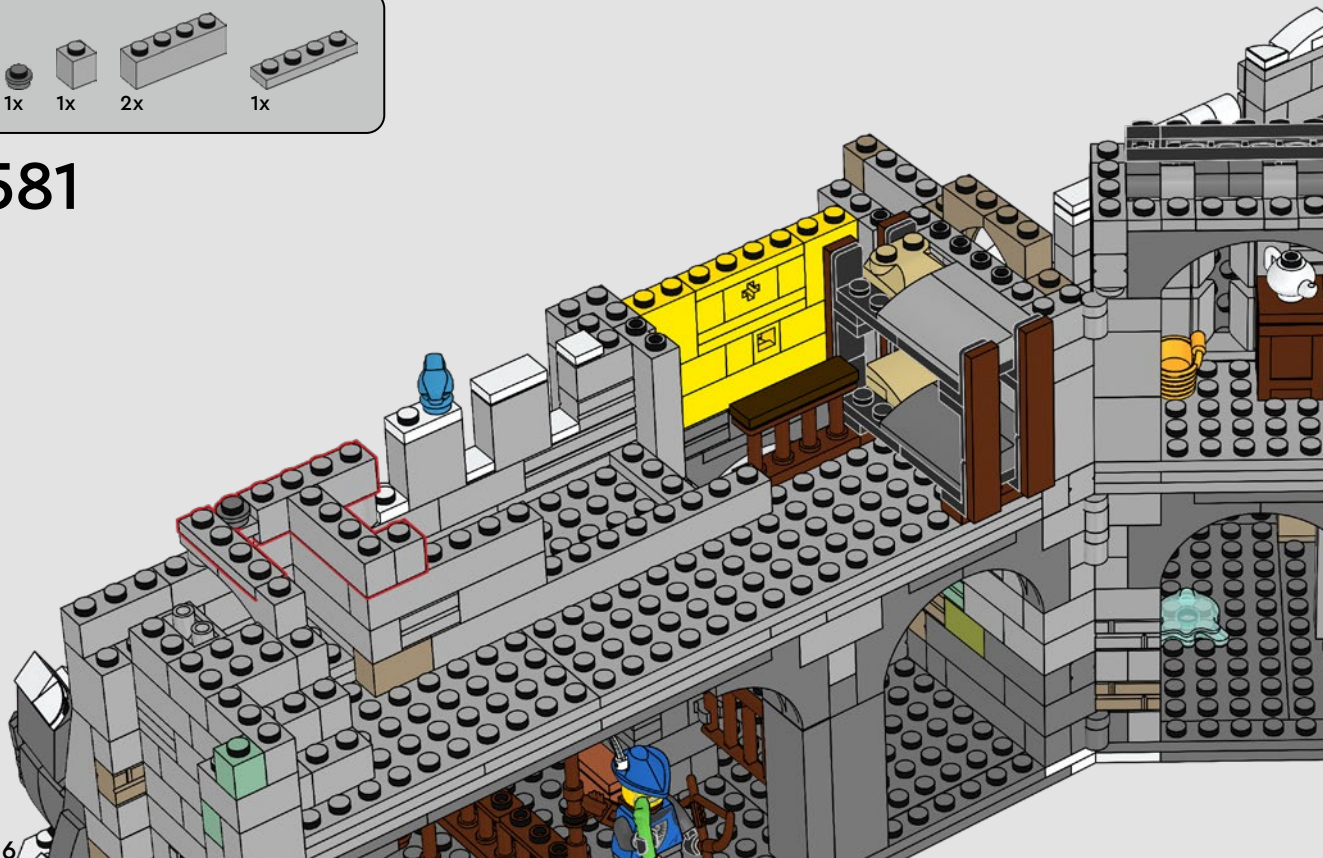

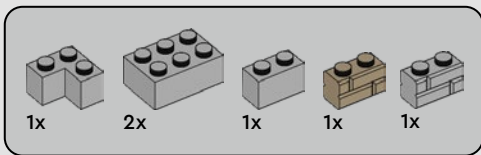

582

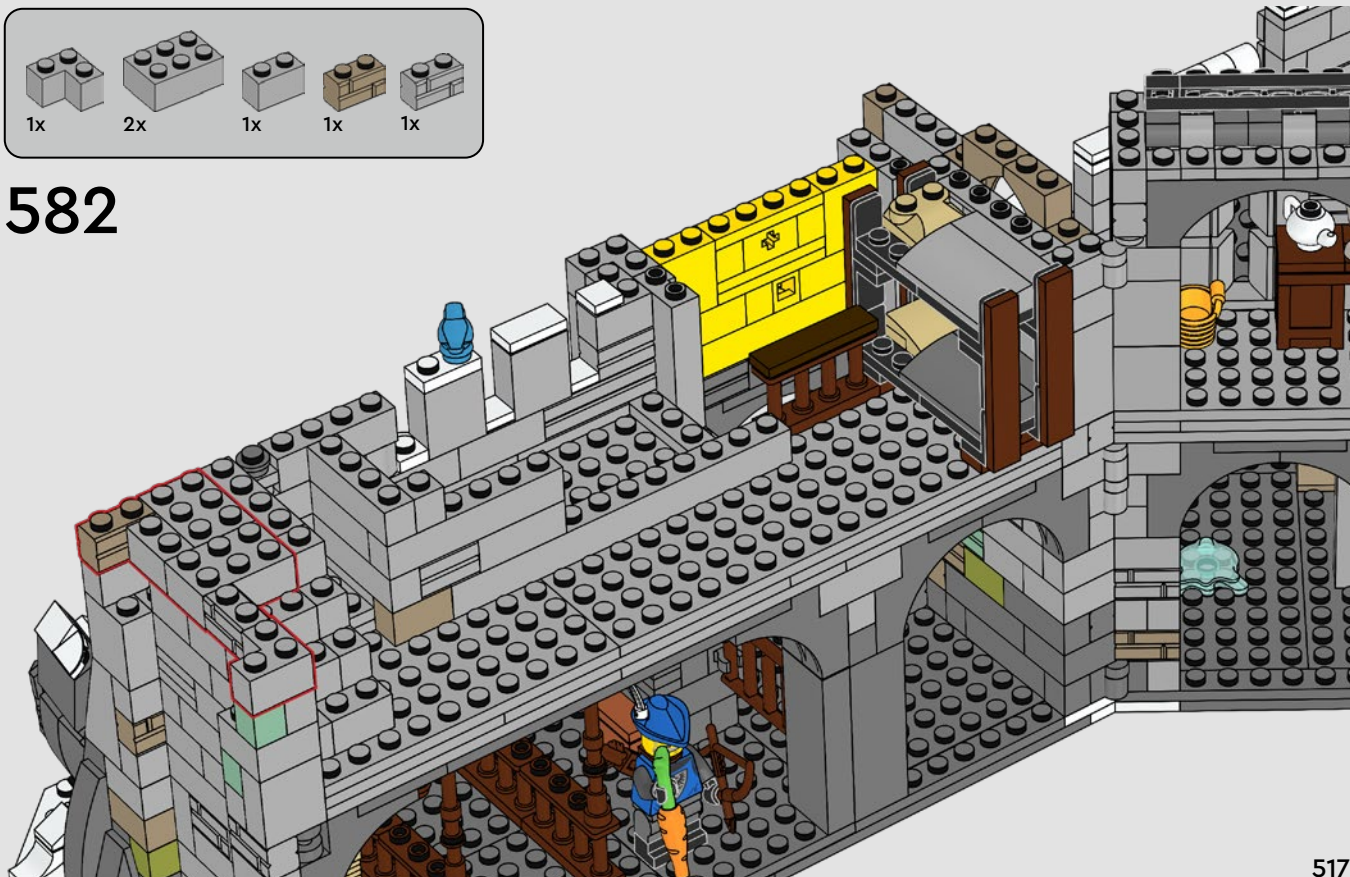

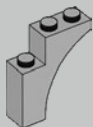

2x

583

518

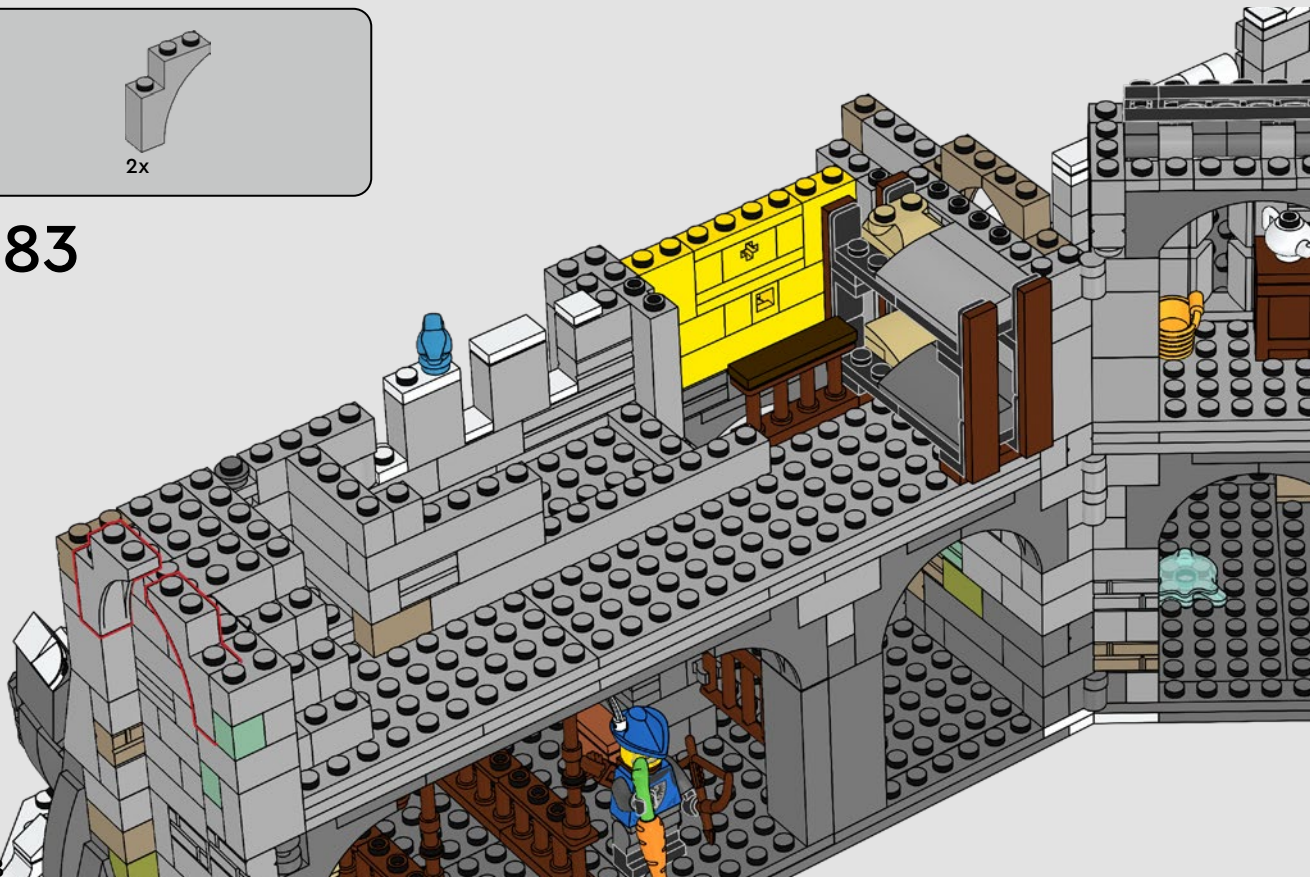



1x



1x

584

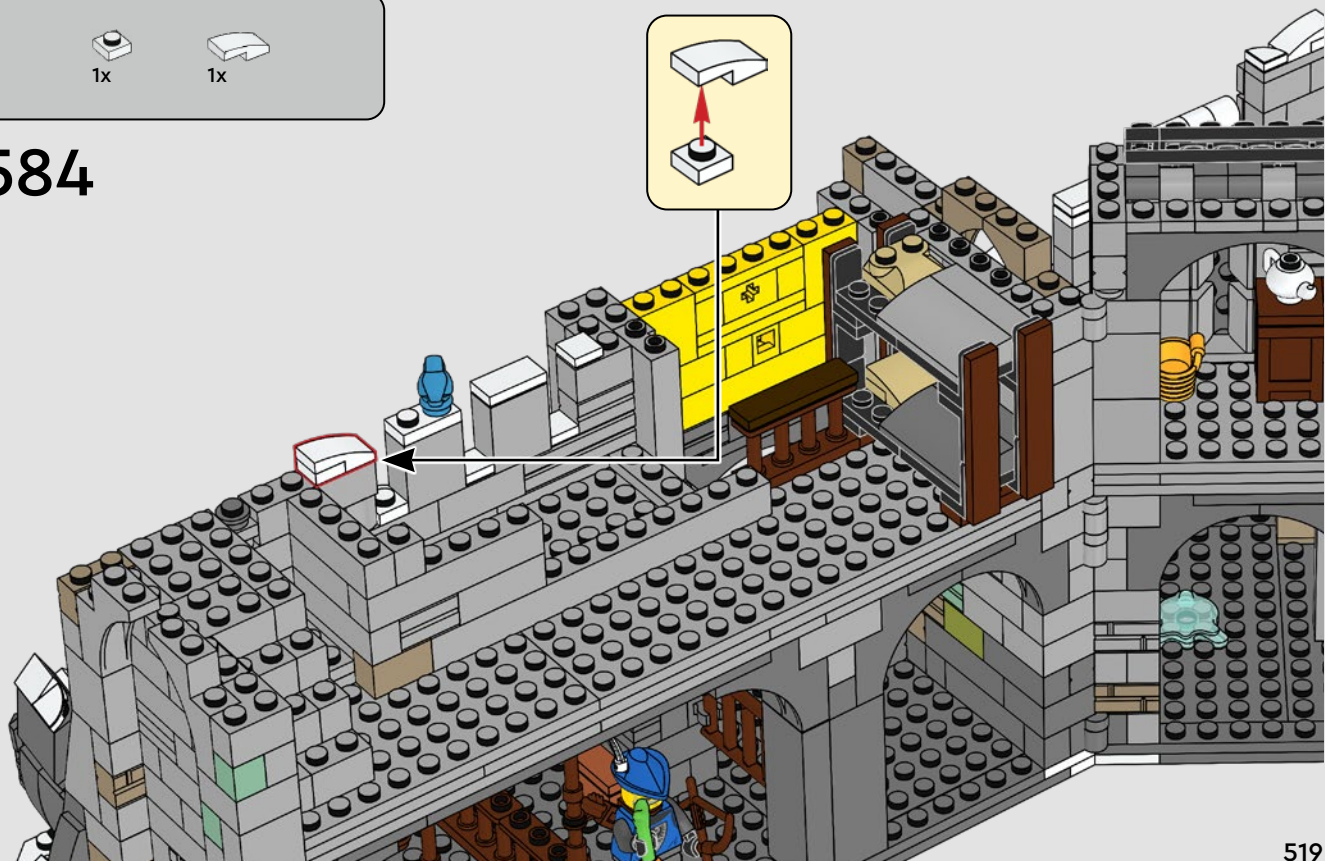
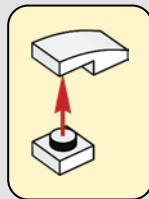

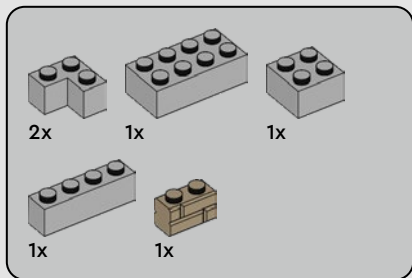

585

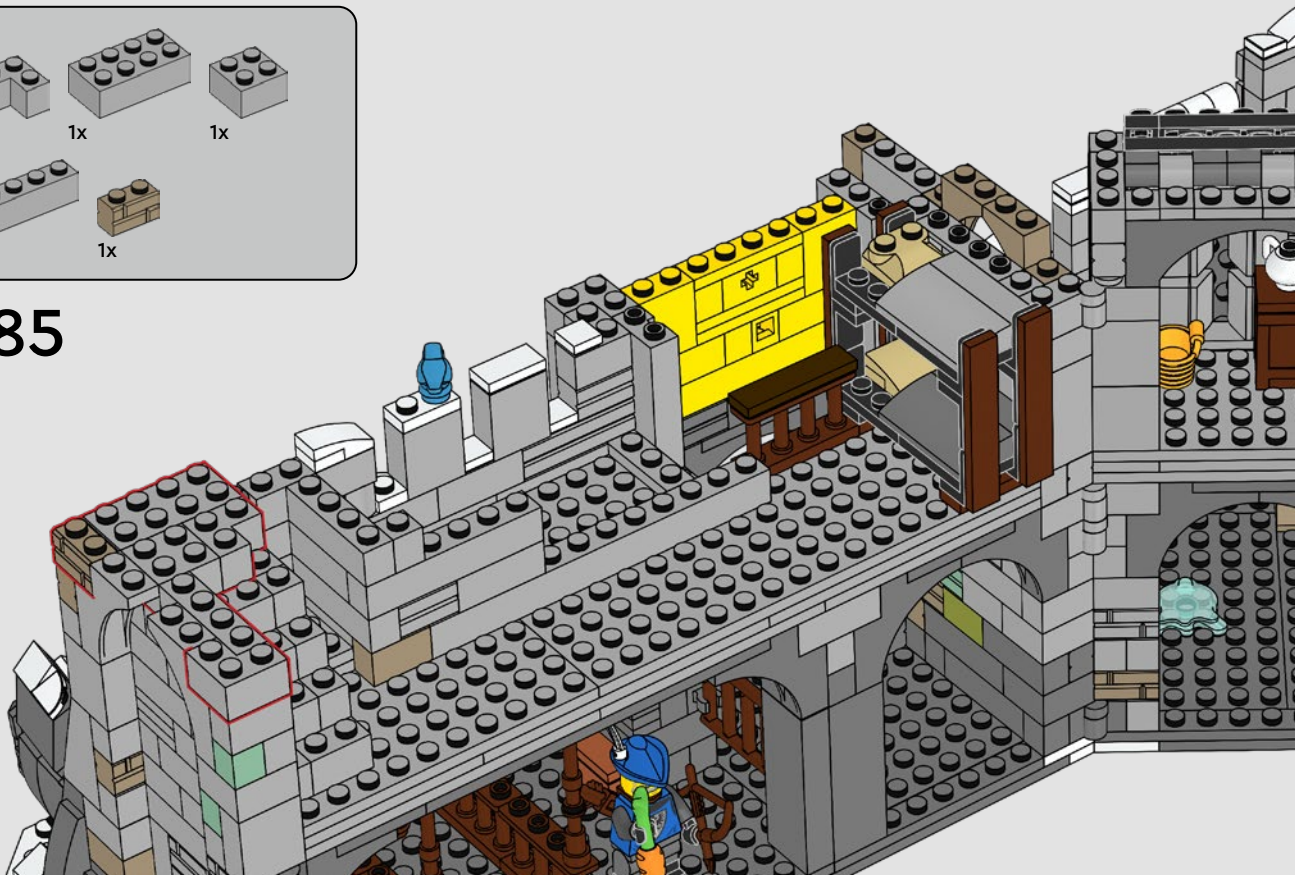

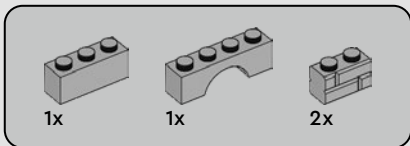

586

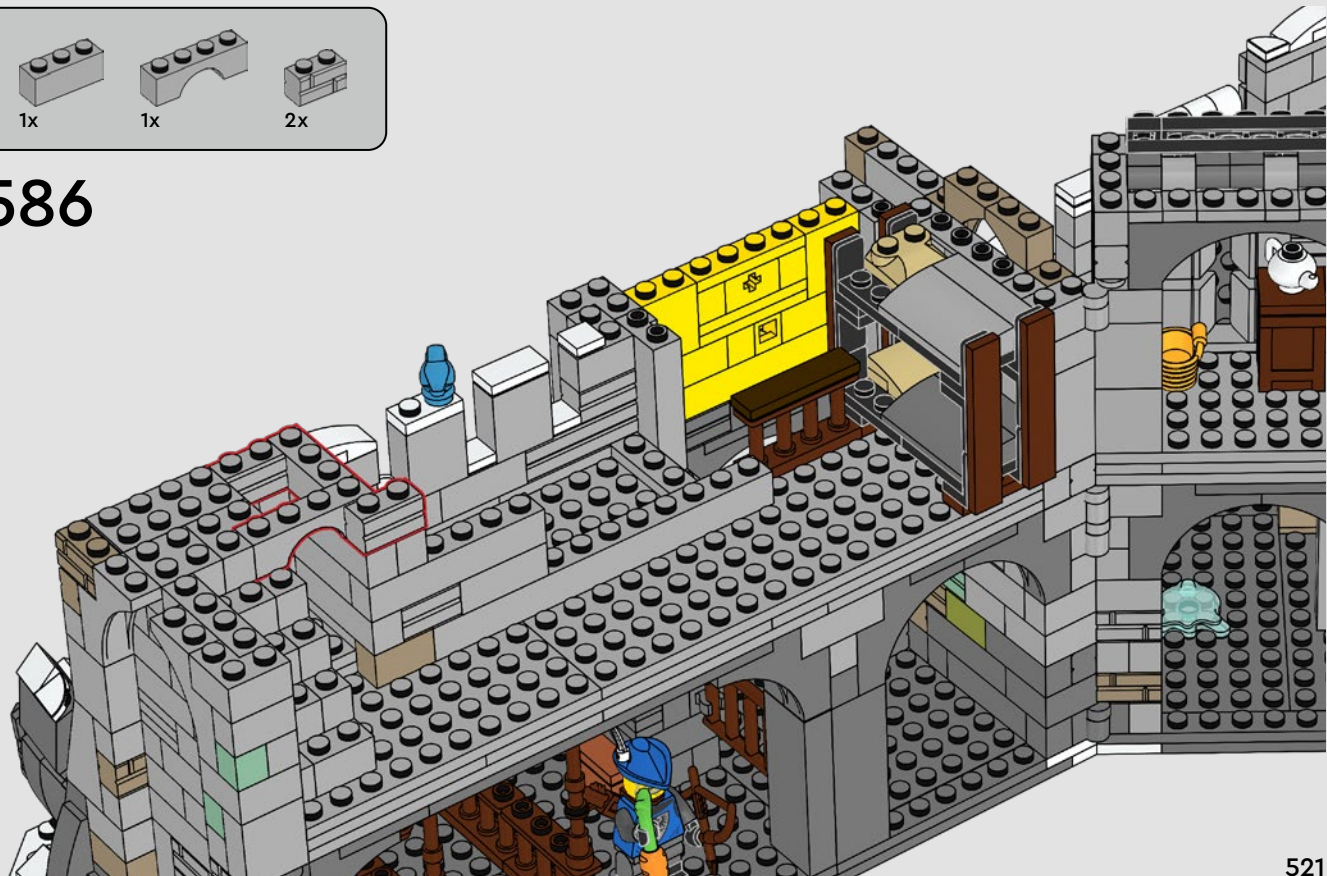

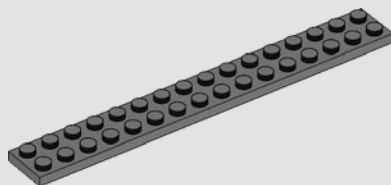
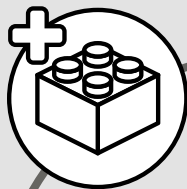

1x

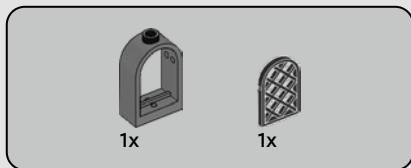

587

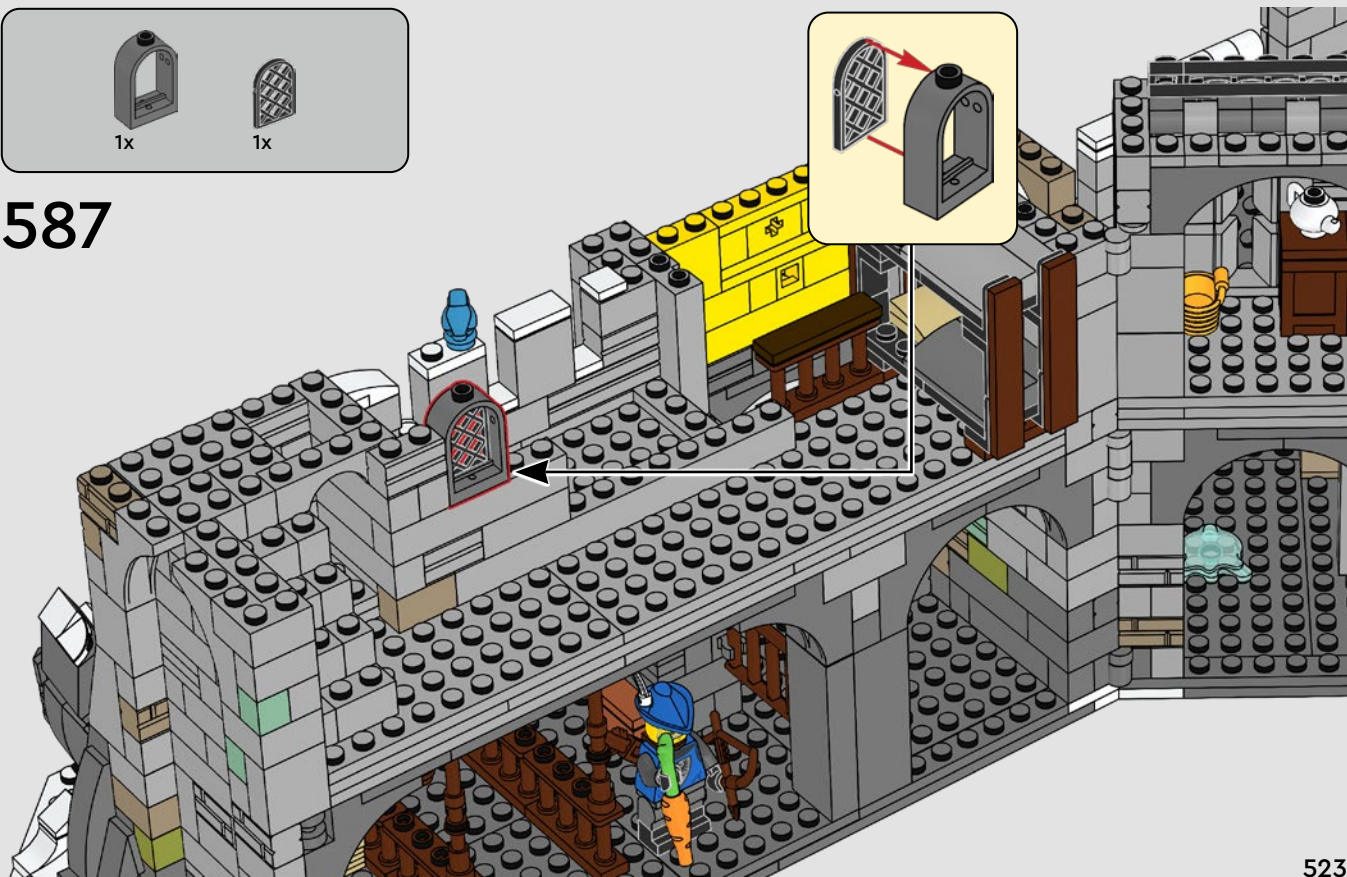
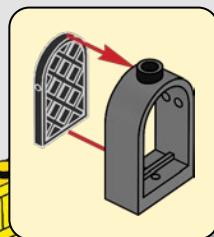



1x



1x

588

524

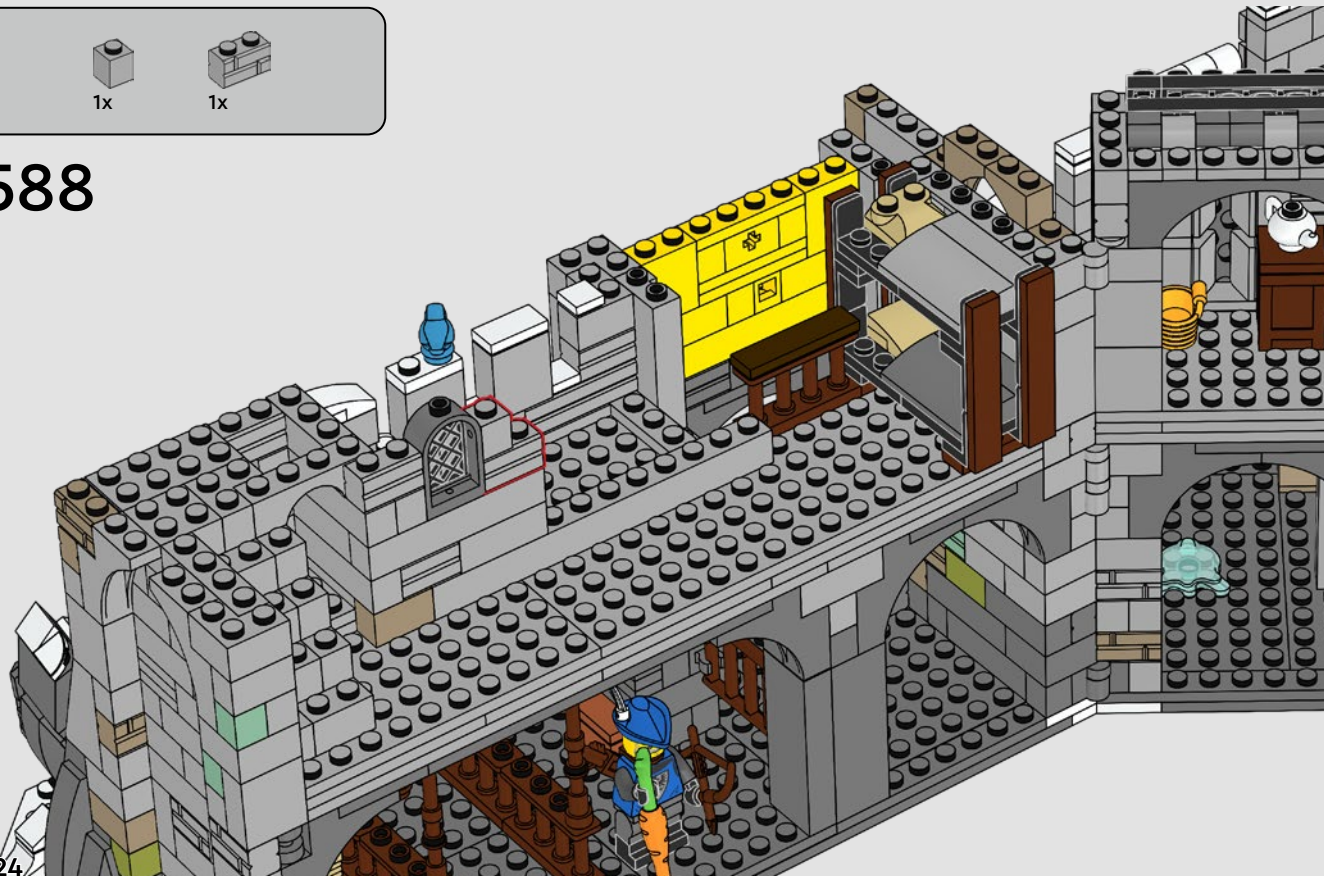

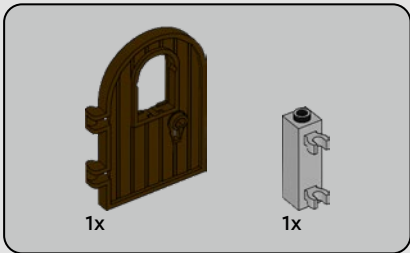
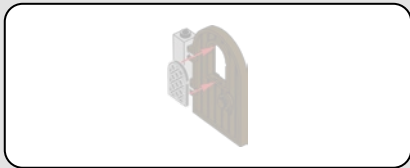

589

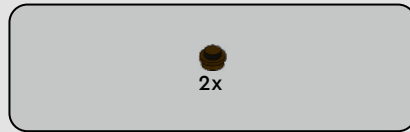

590

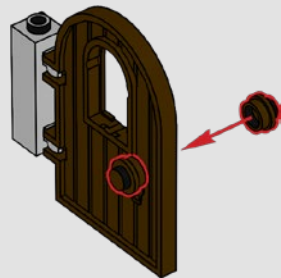

591

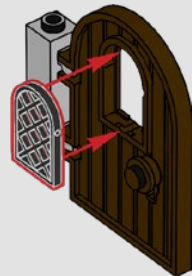

592

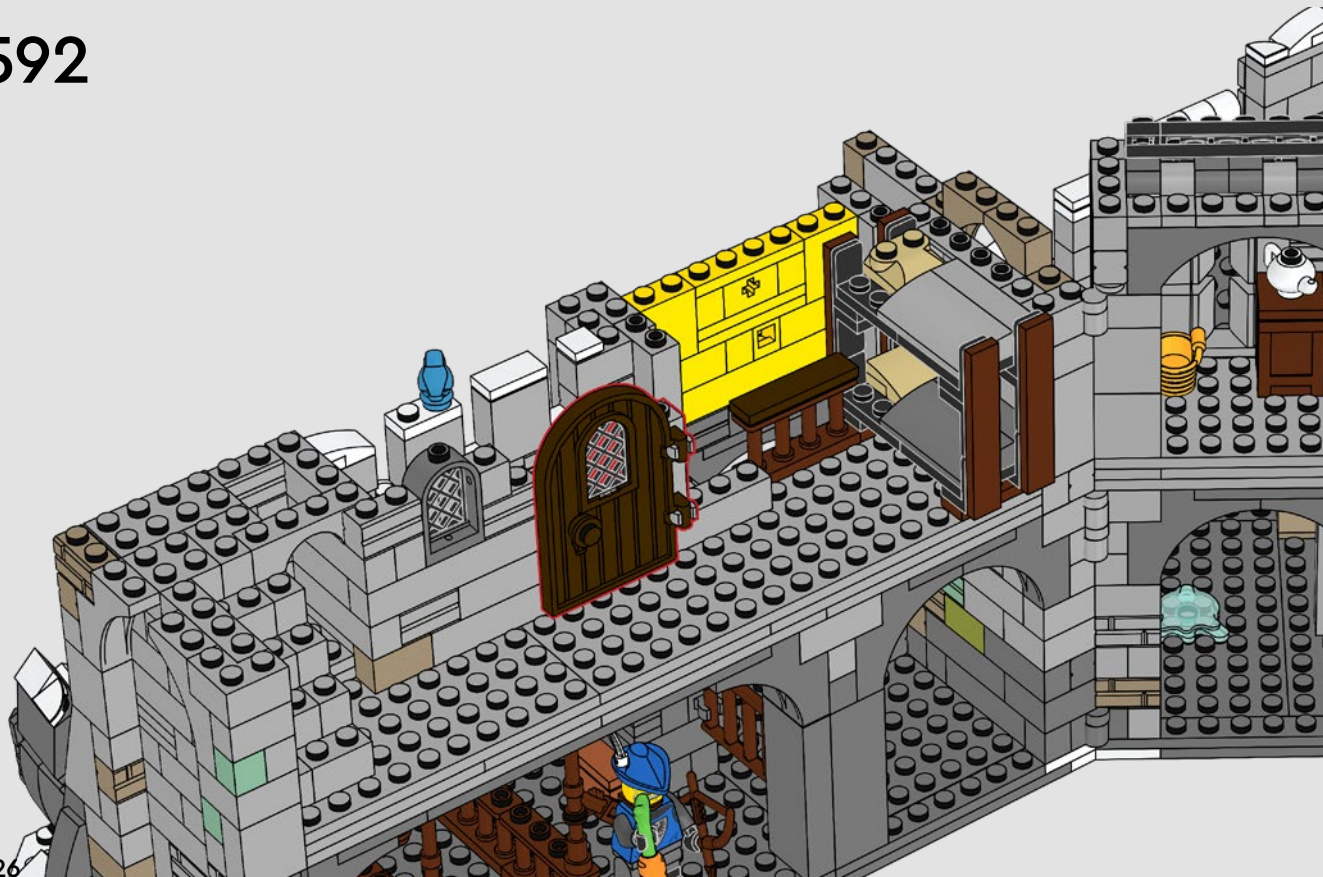

526

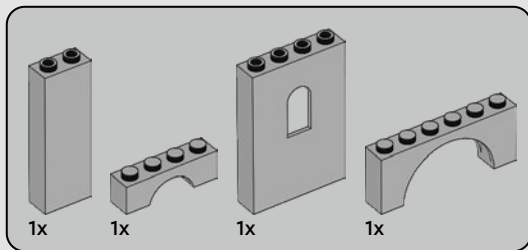

593

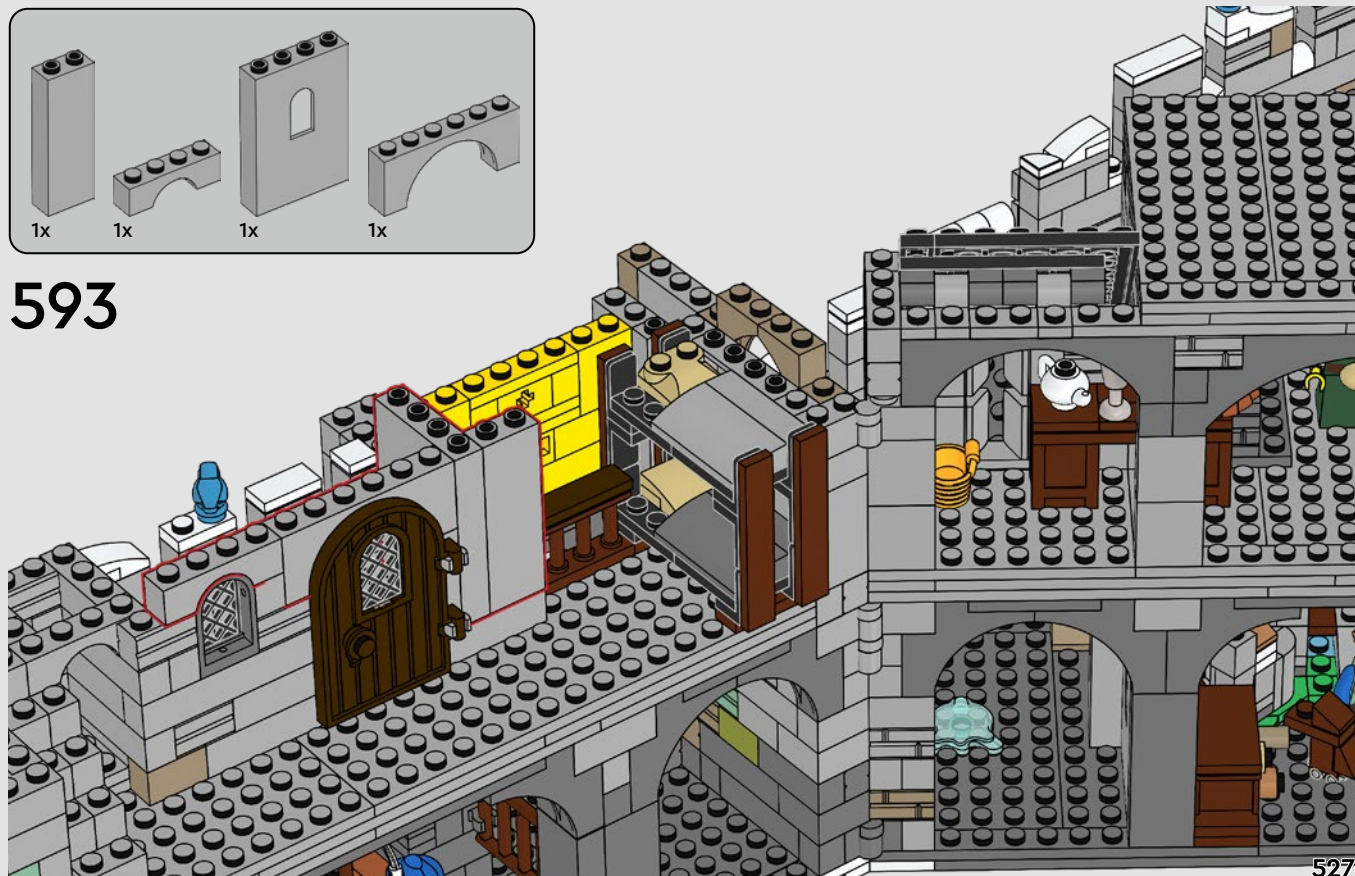

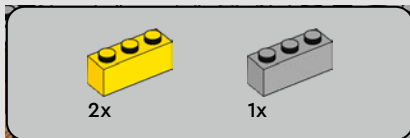

594

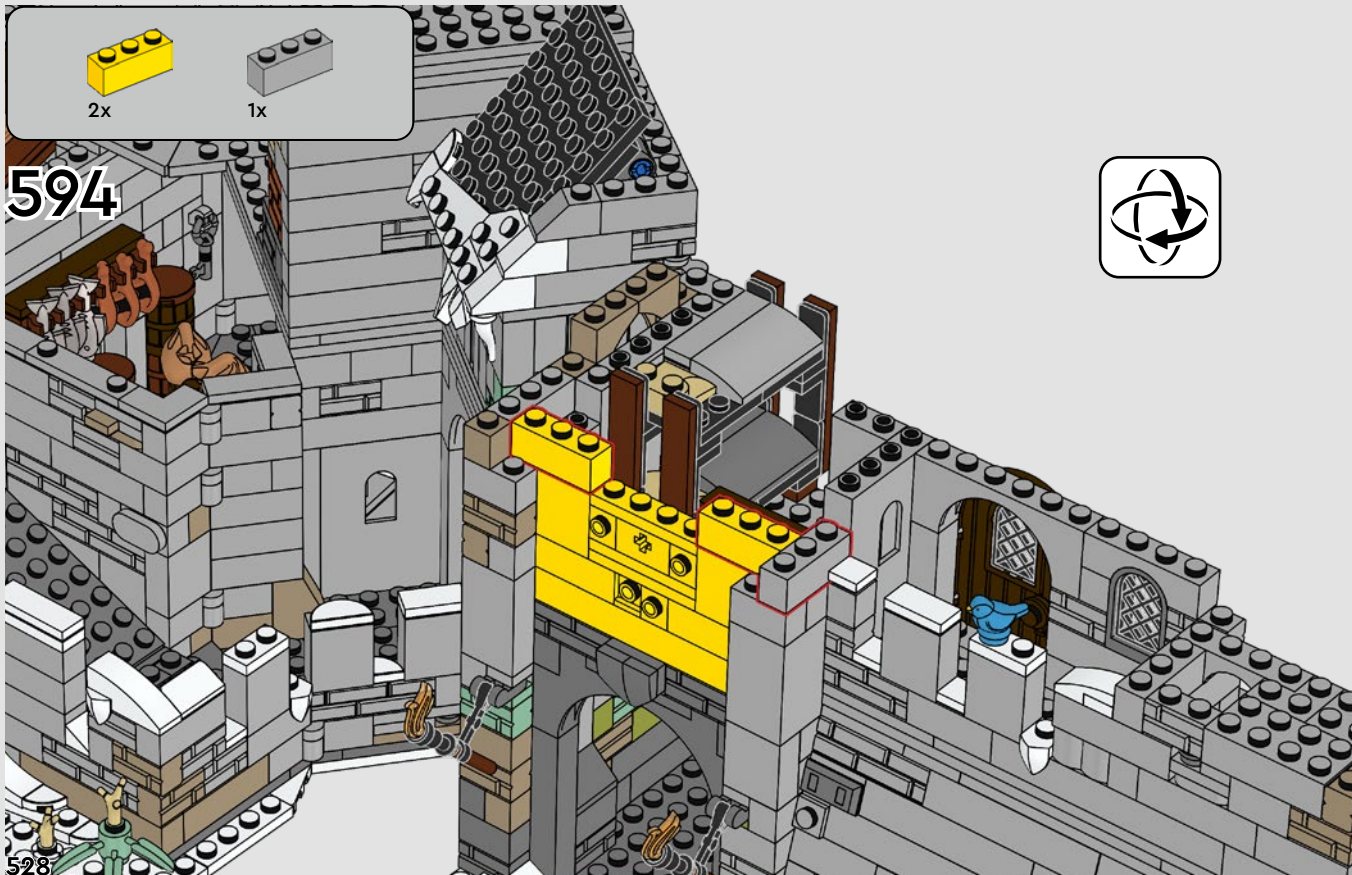

528

1x

2x

595

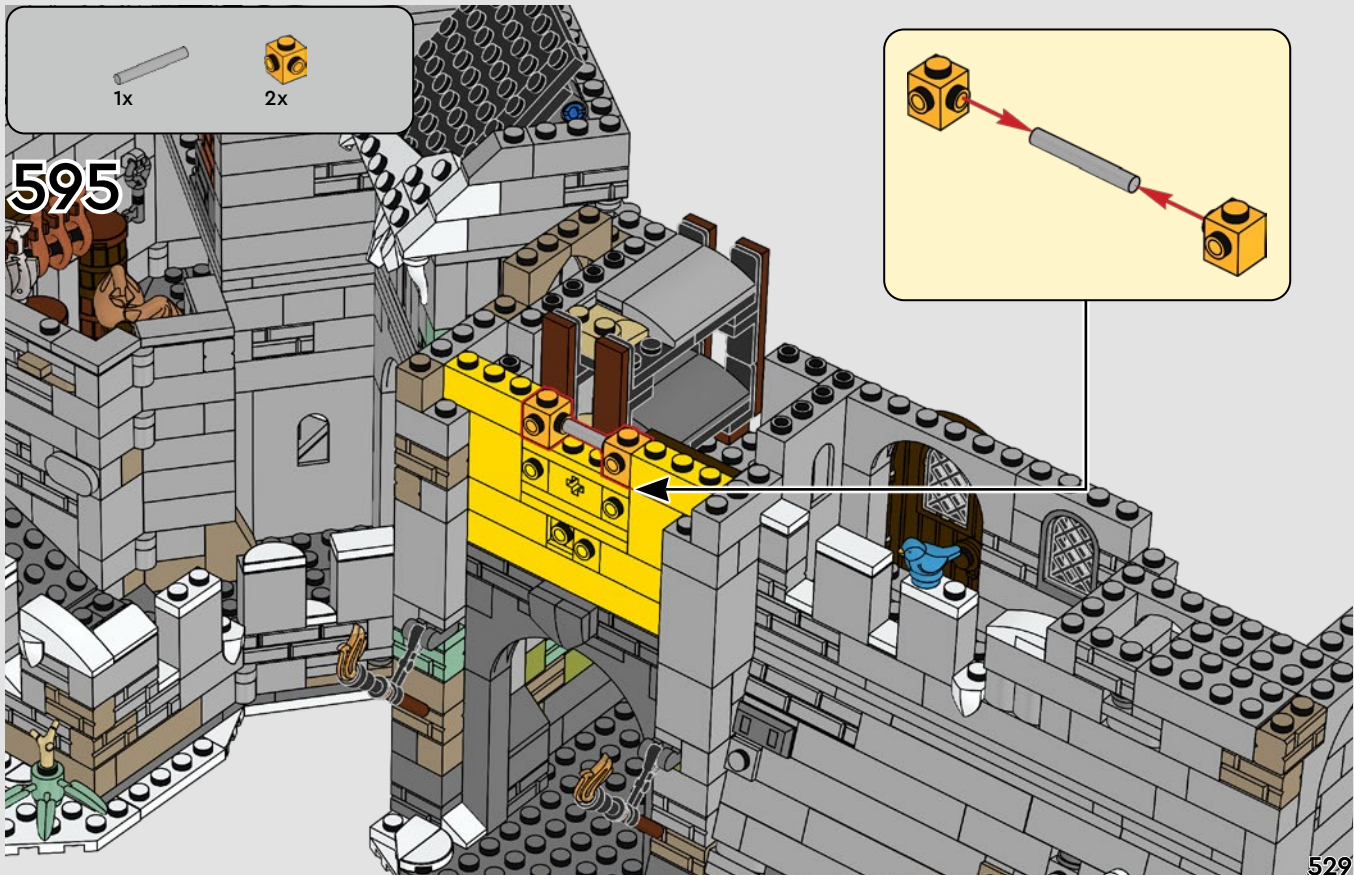
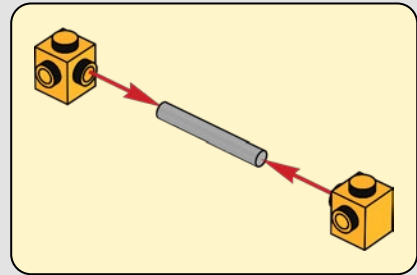

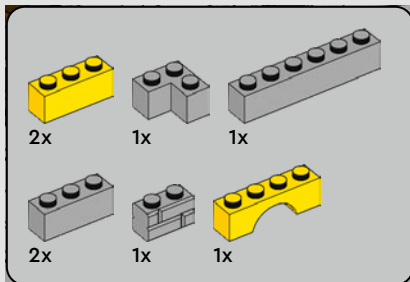

596

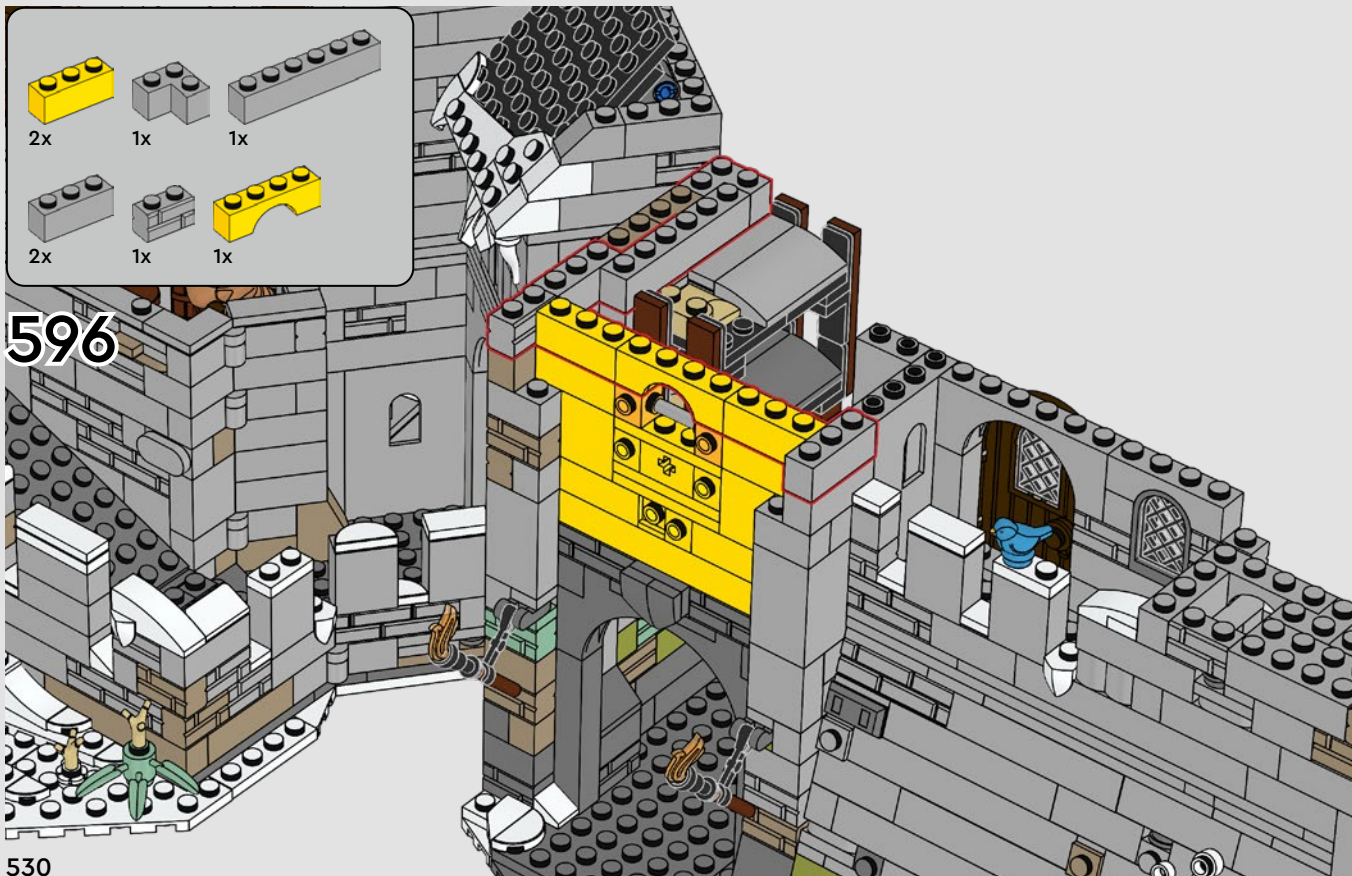

530



597

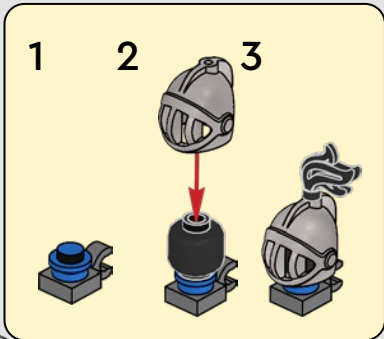
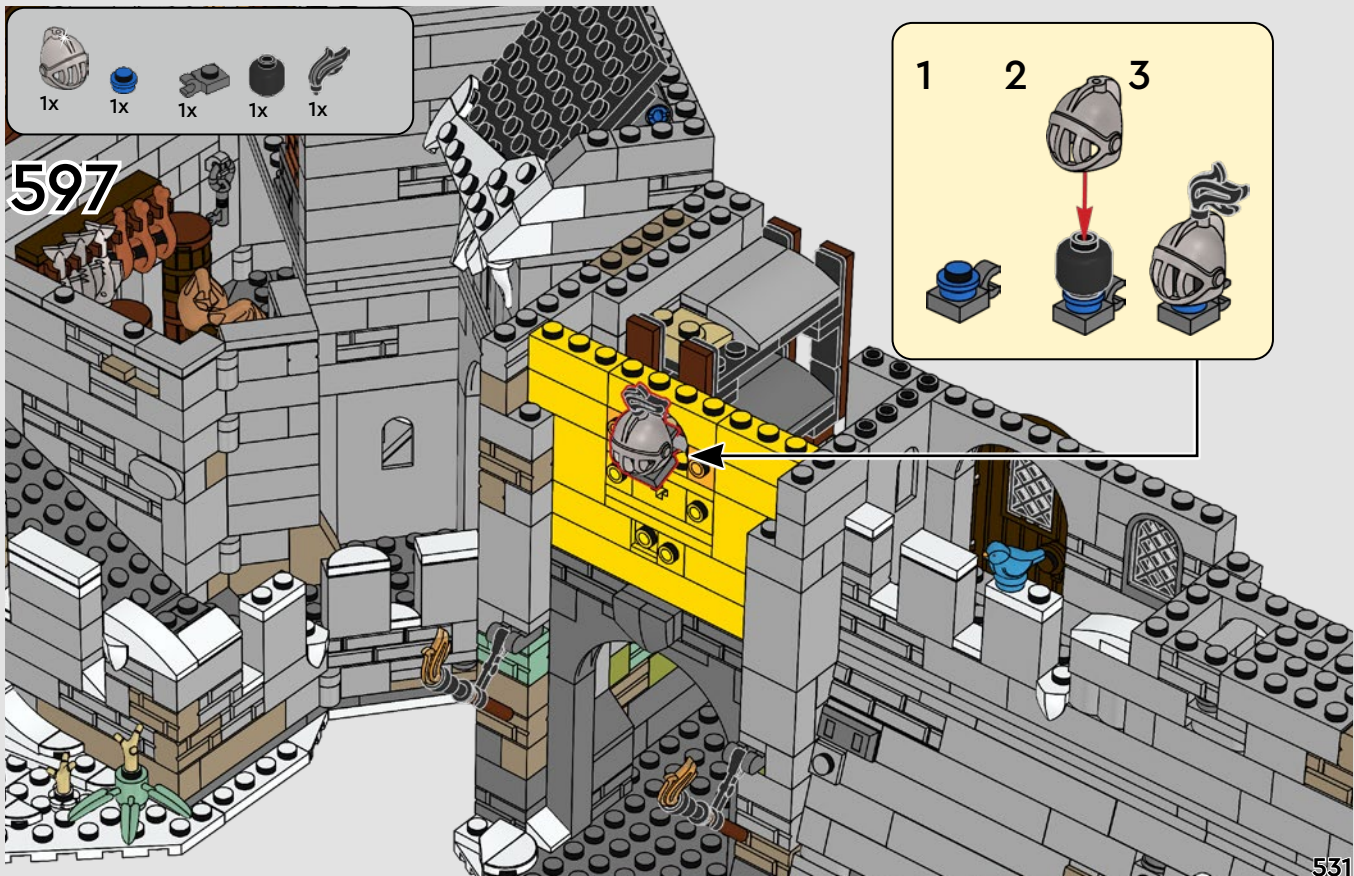



2x



2x

598



2x



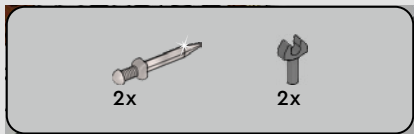

599

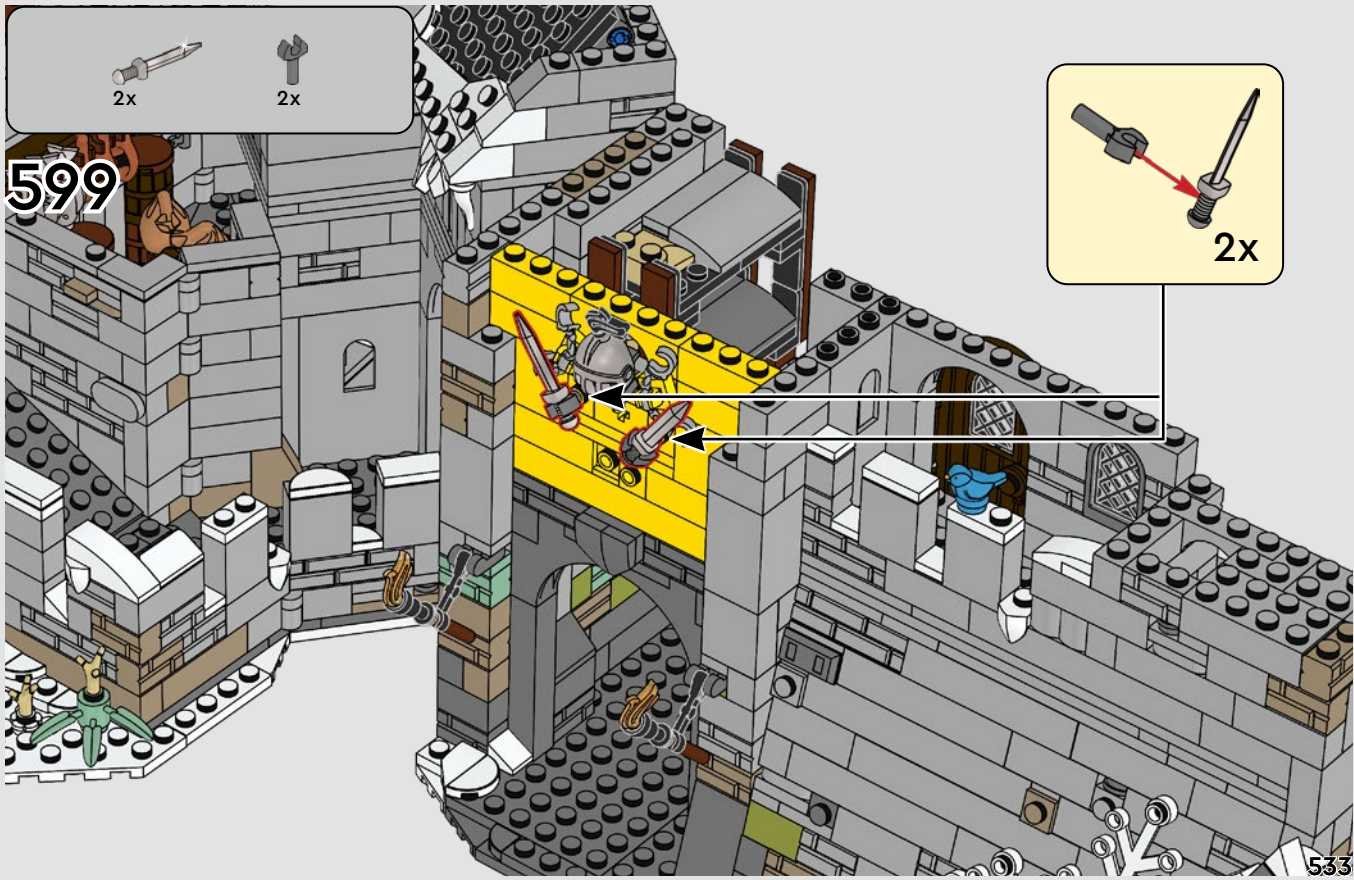
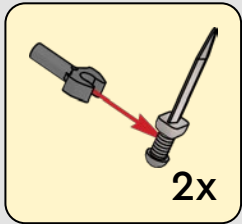



1x

600





601

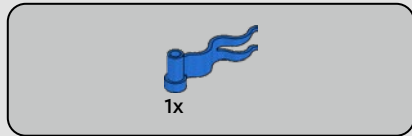

602

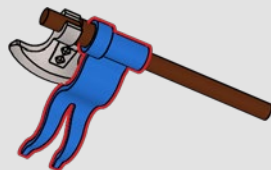

603

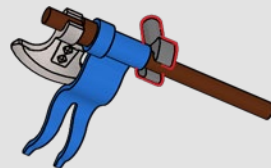

604





605

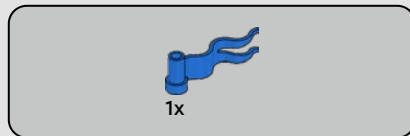

606

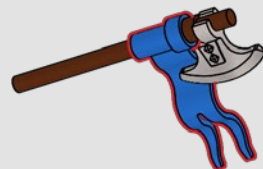

607



608

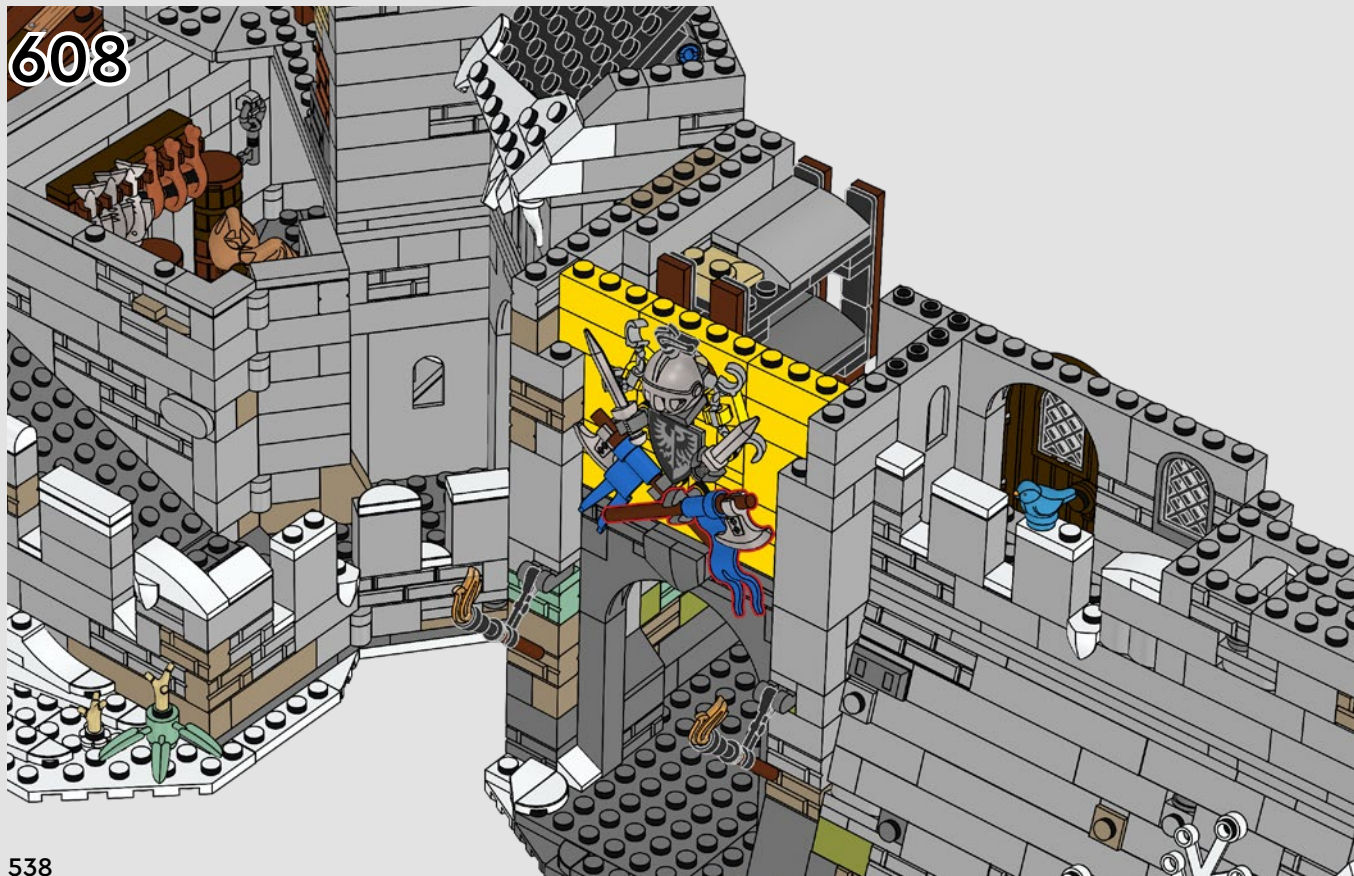

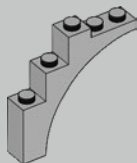

2x

609



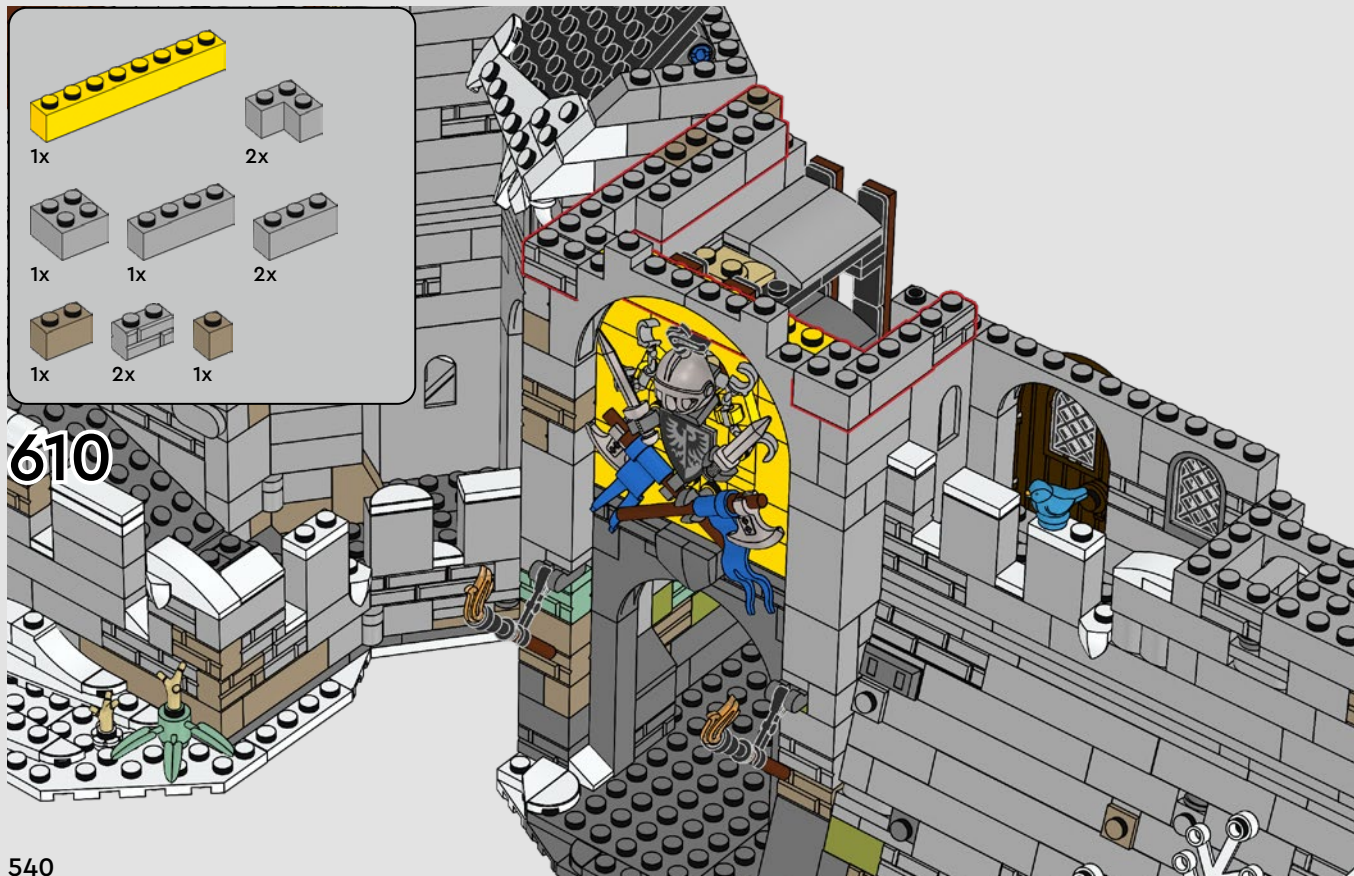

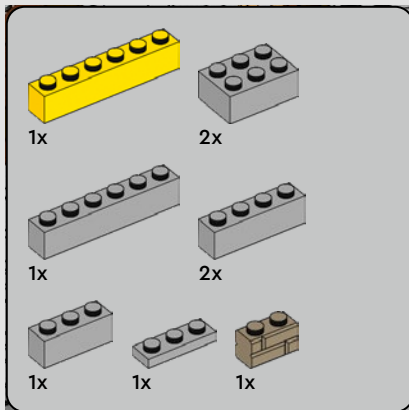

611

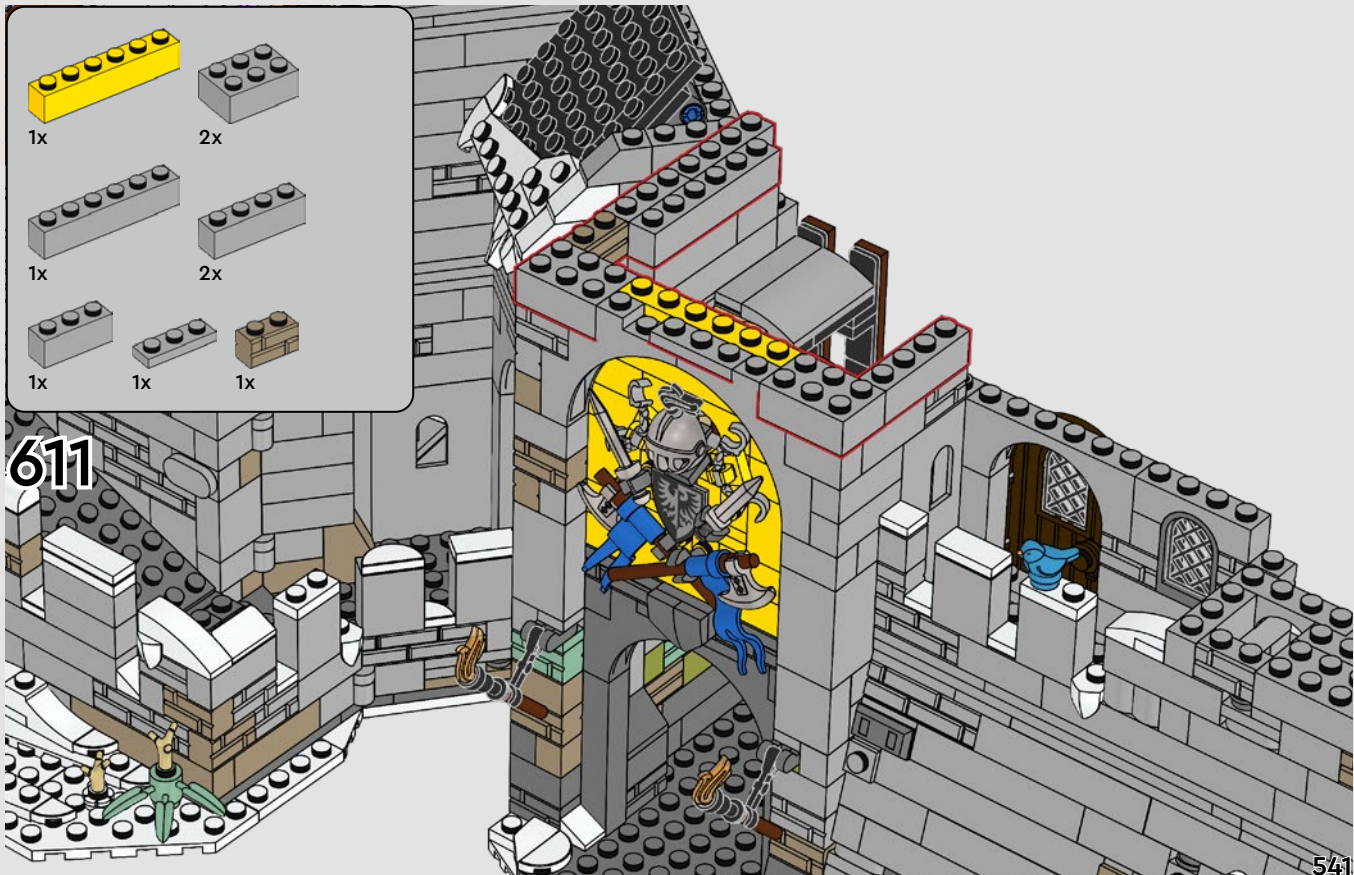

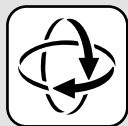
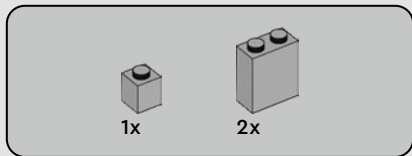

612

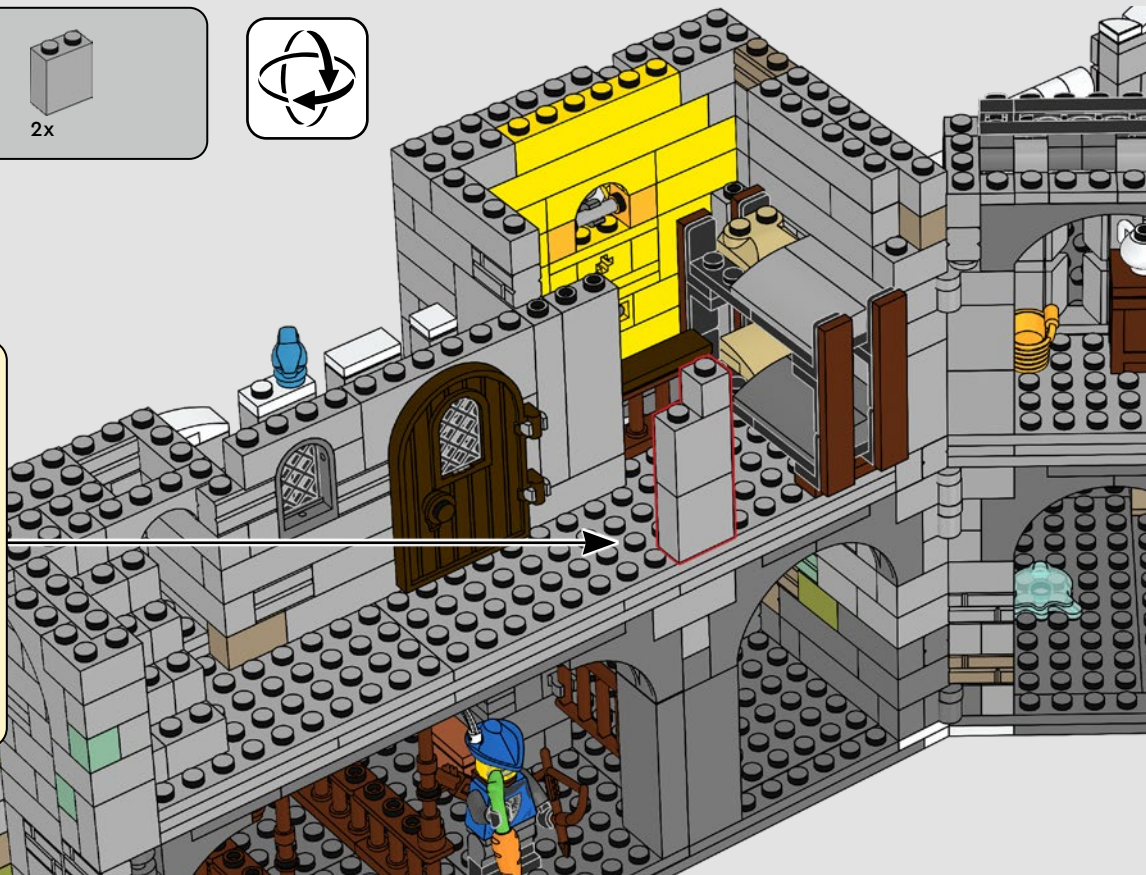
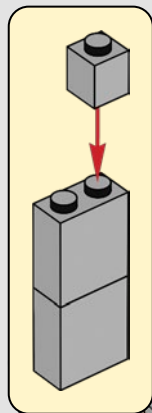

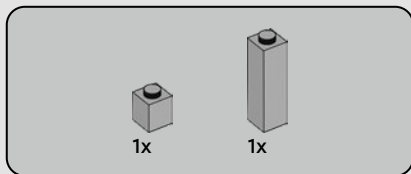

613

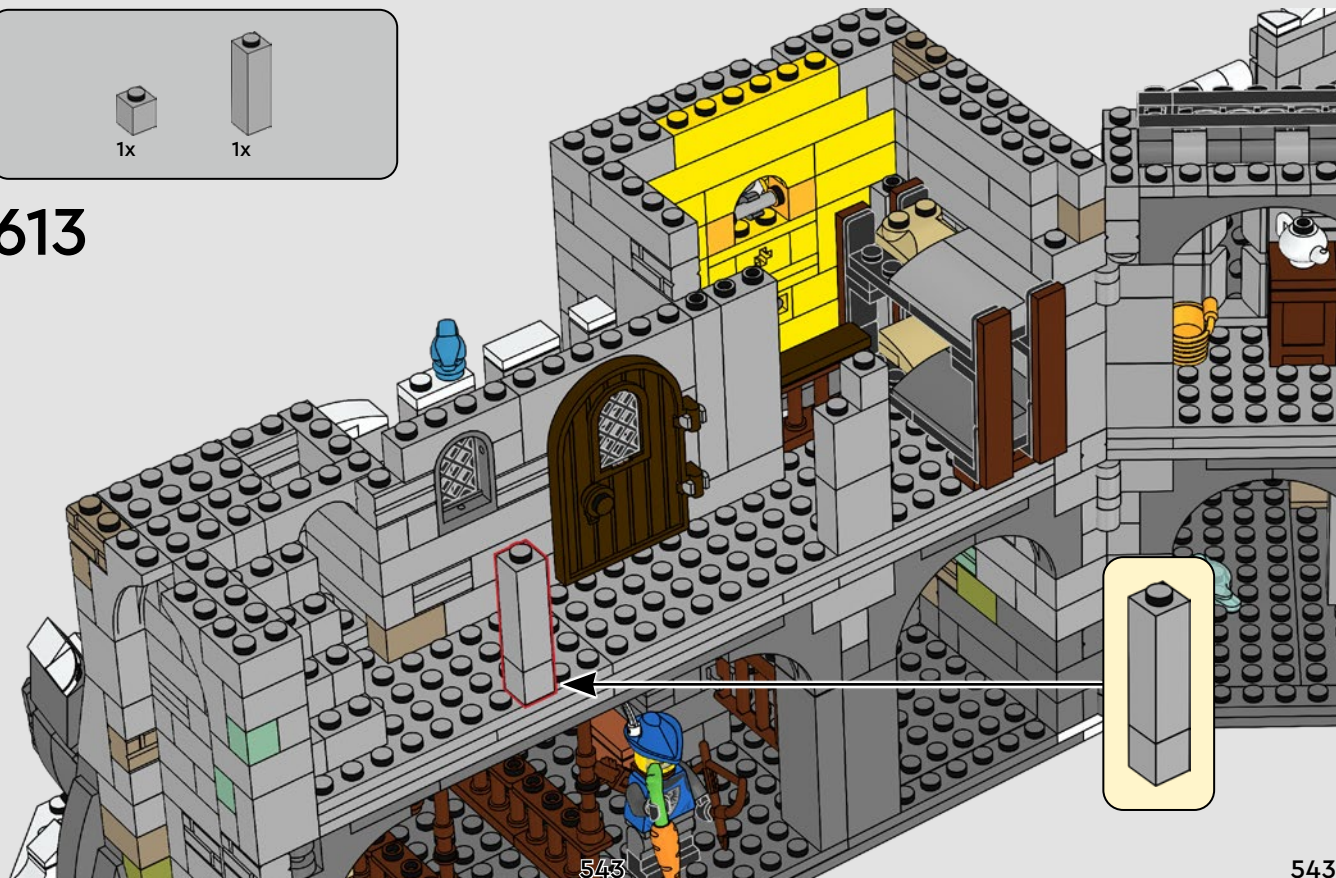

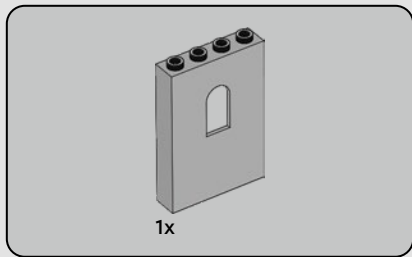

614

544

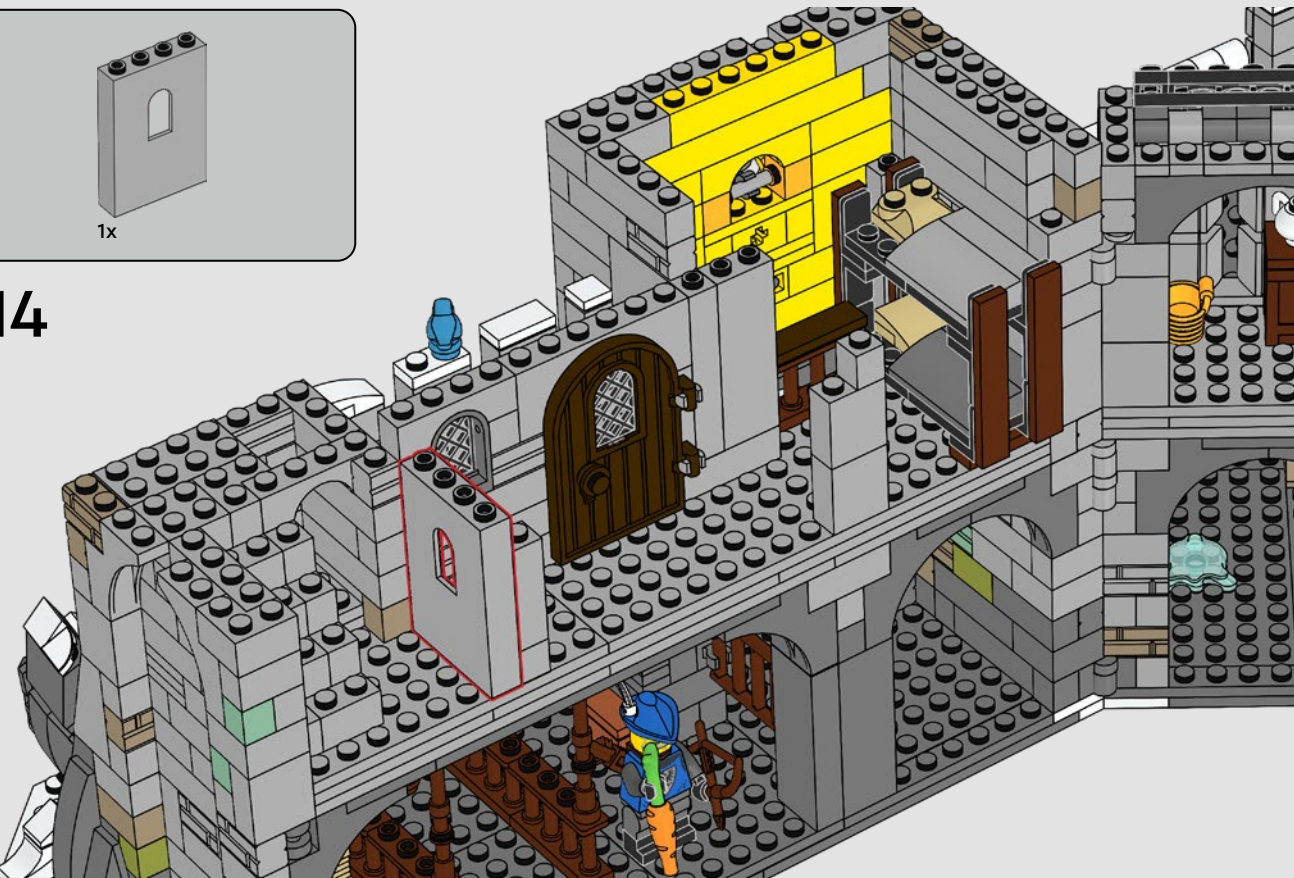

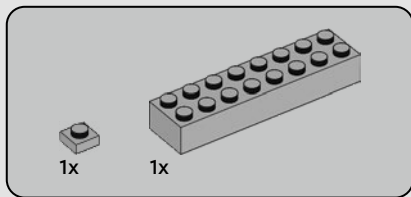

615

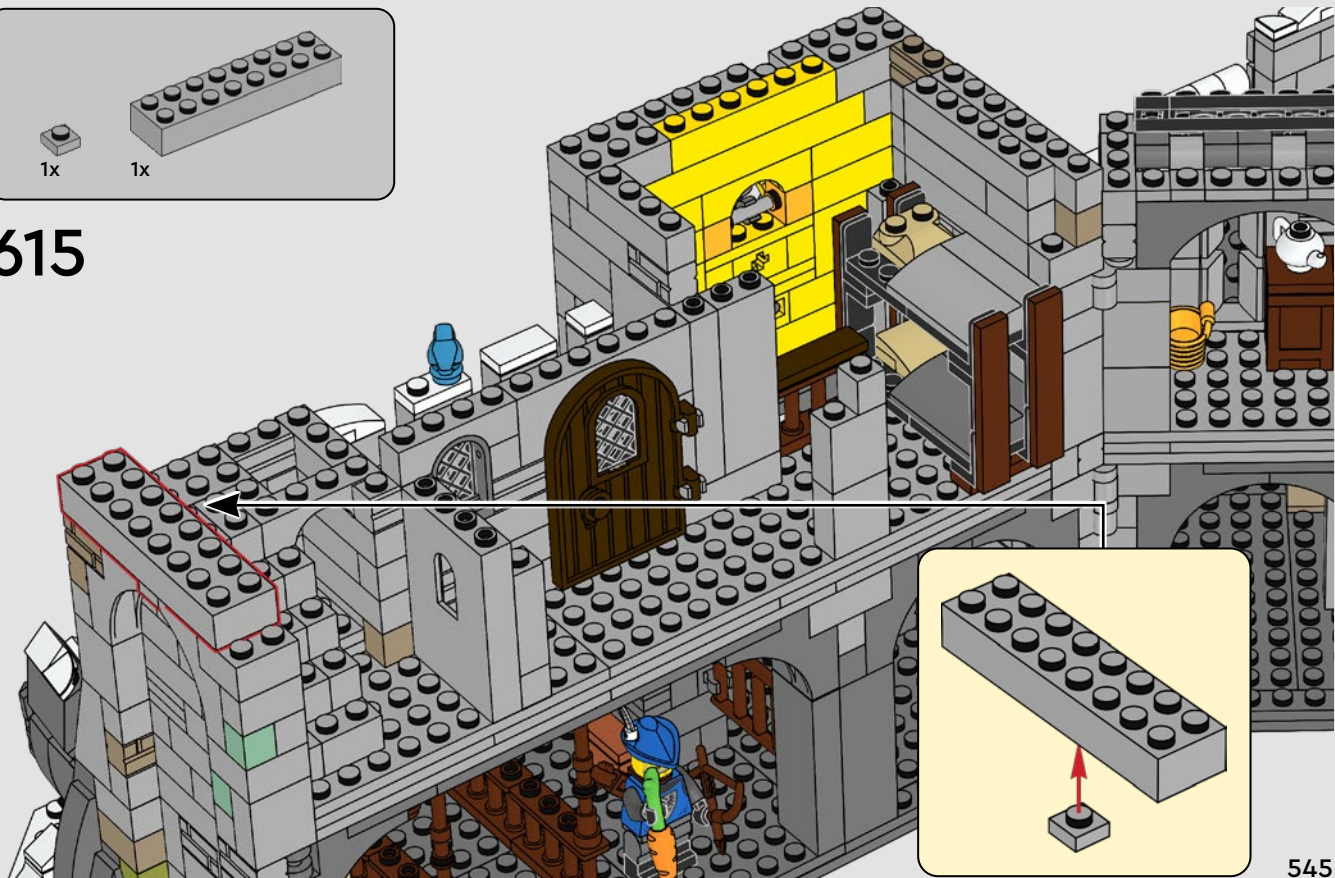

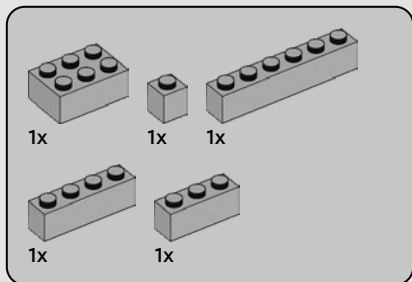

616



546

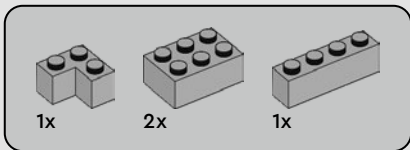

617





1x



1x

618

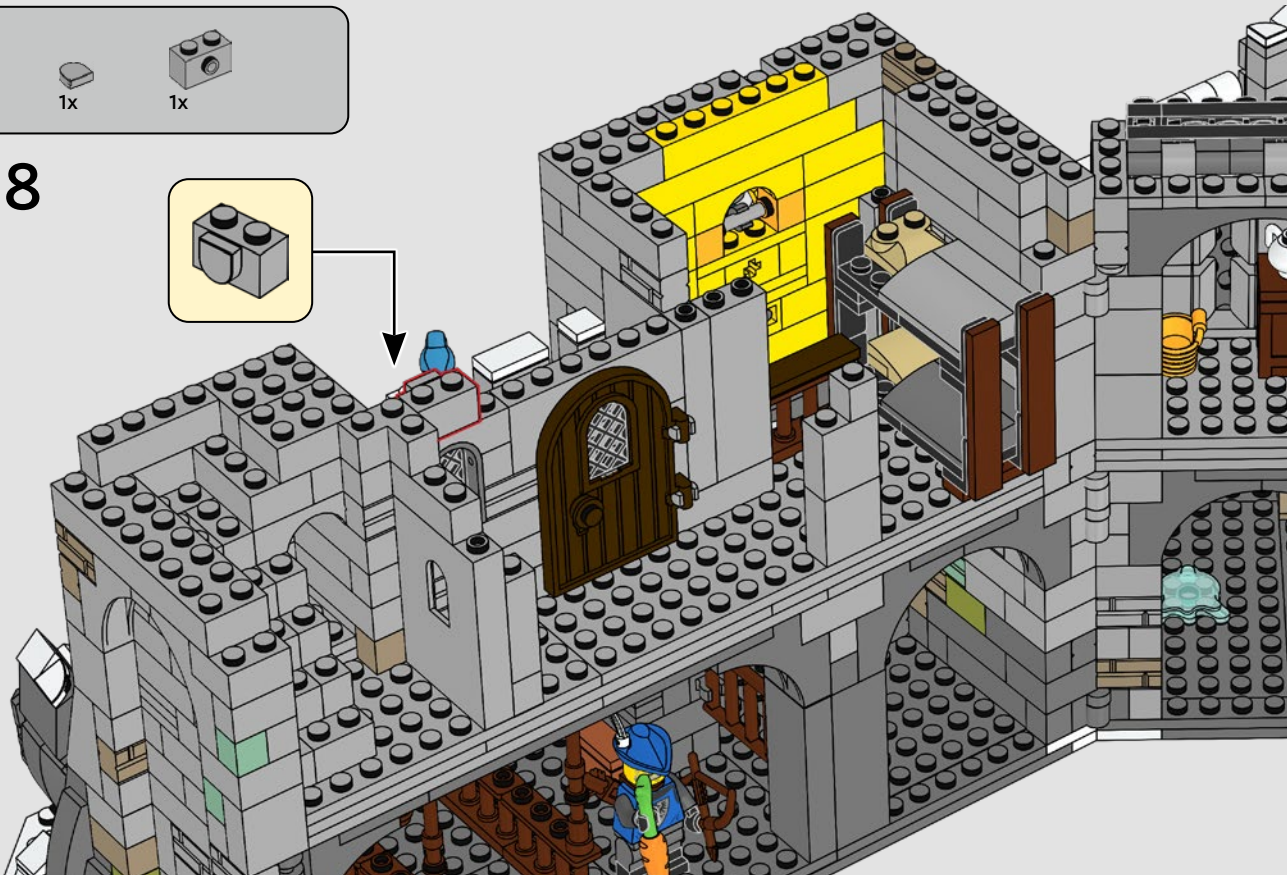
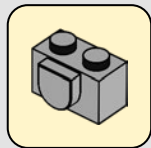



1x



1x

619

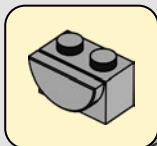

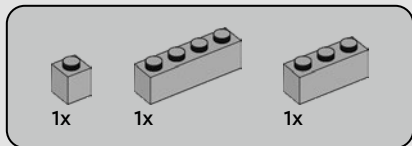

620



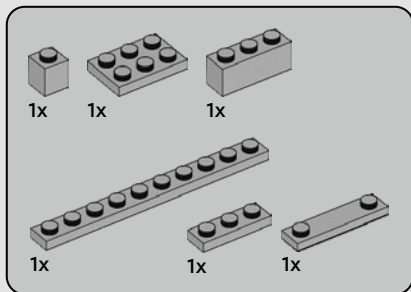

621

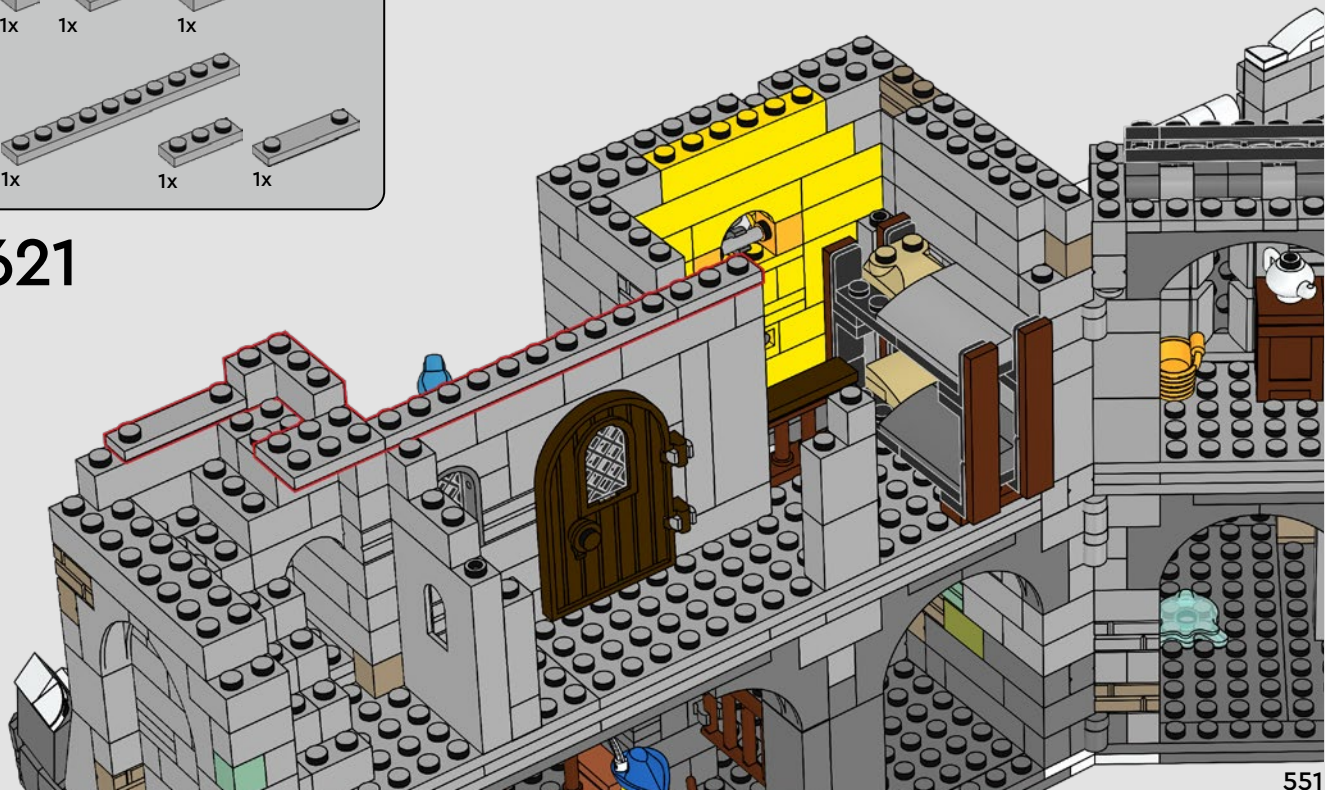

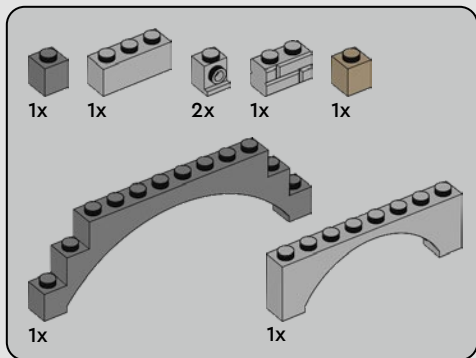

622

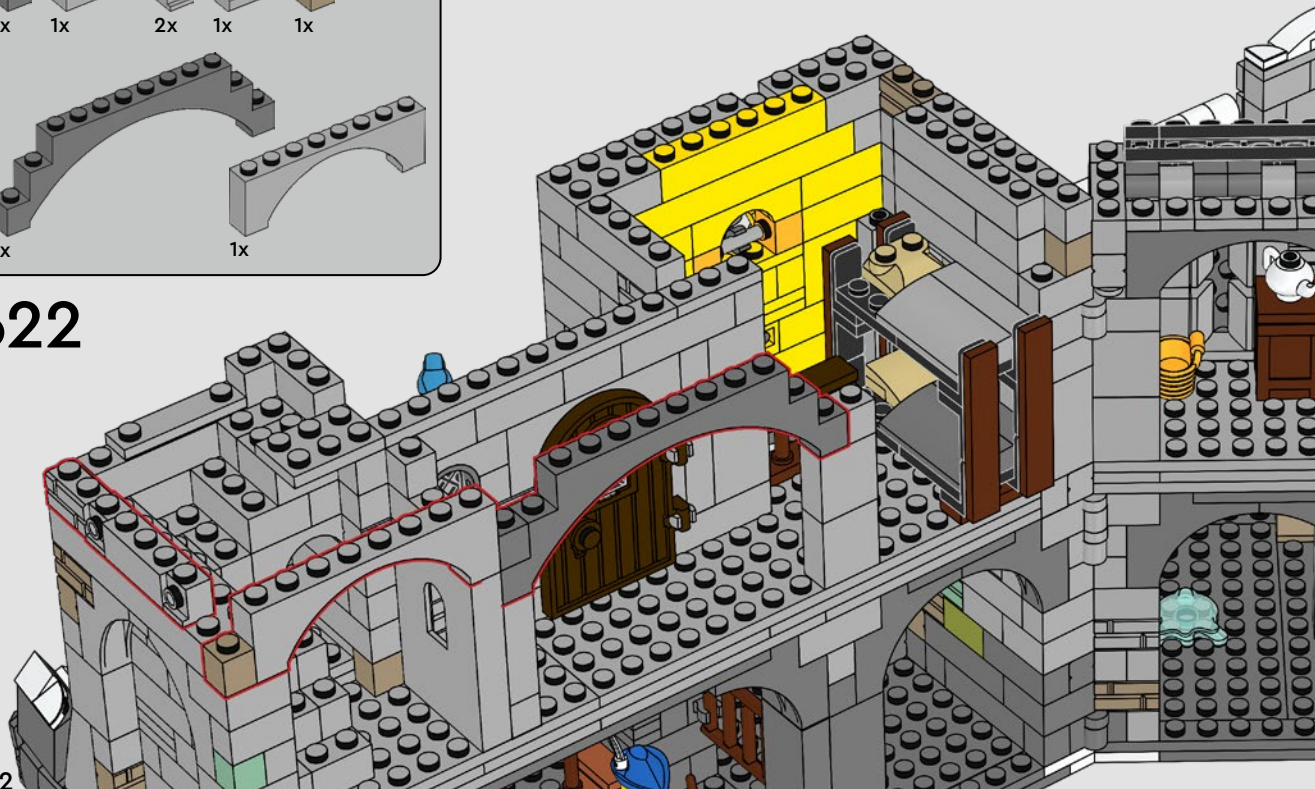



2x



1x



2x

623





1x



2x

624

1



2





1x



1x

625



1x



1x

626

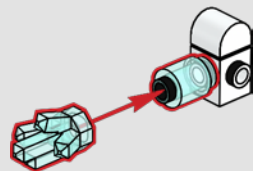

1x



1x

627

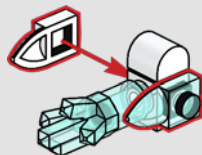

628



556

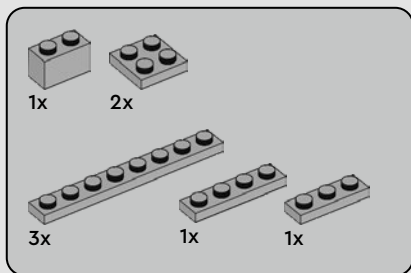

629



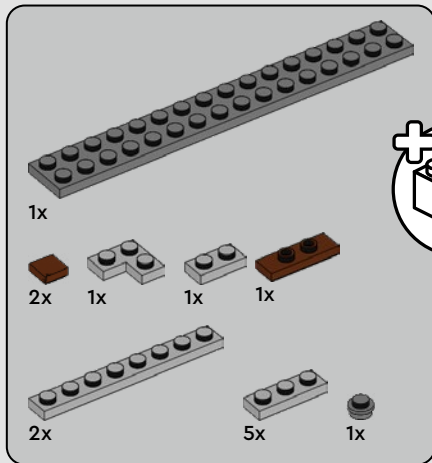

630

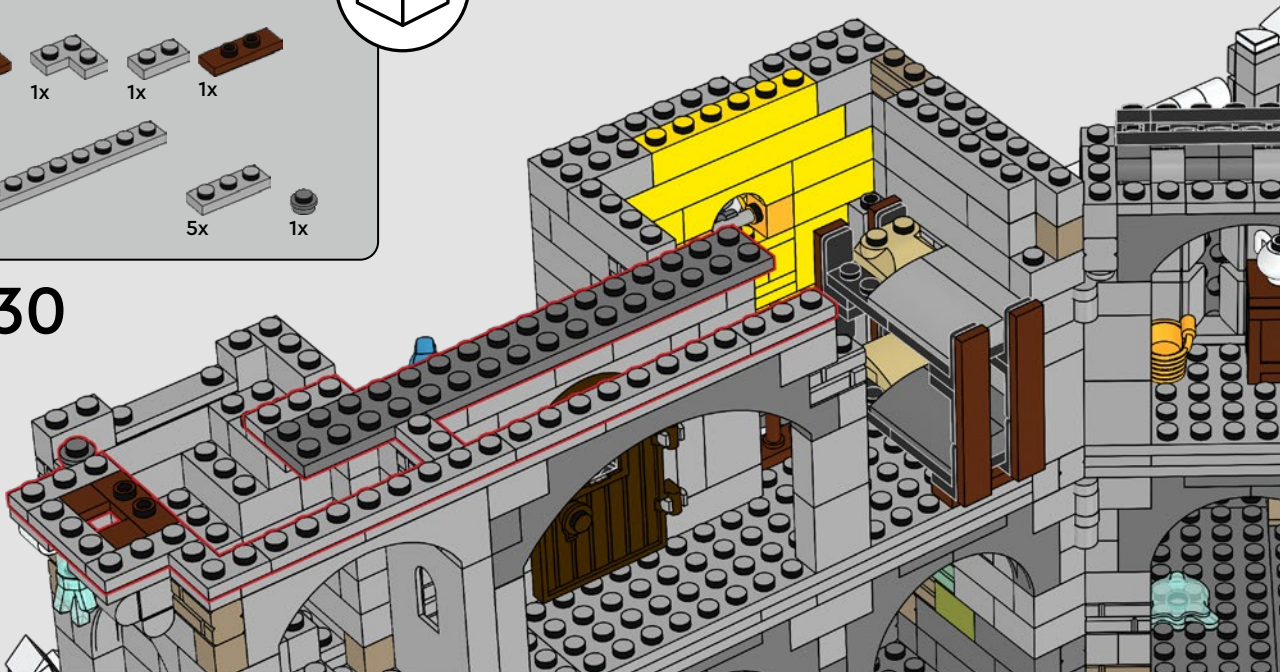

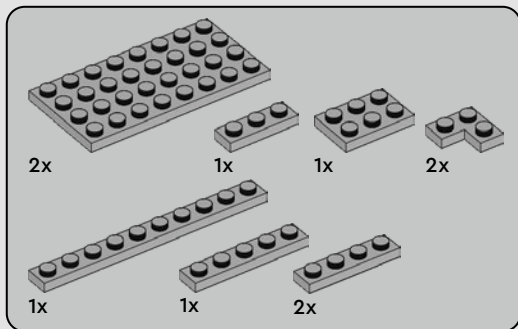

631

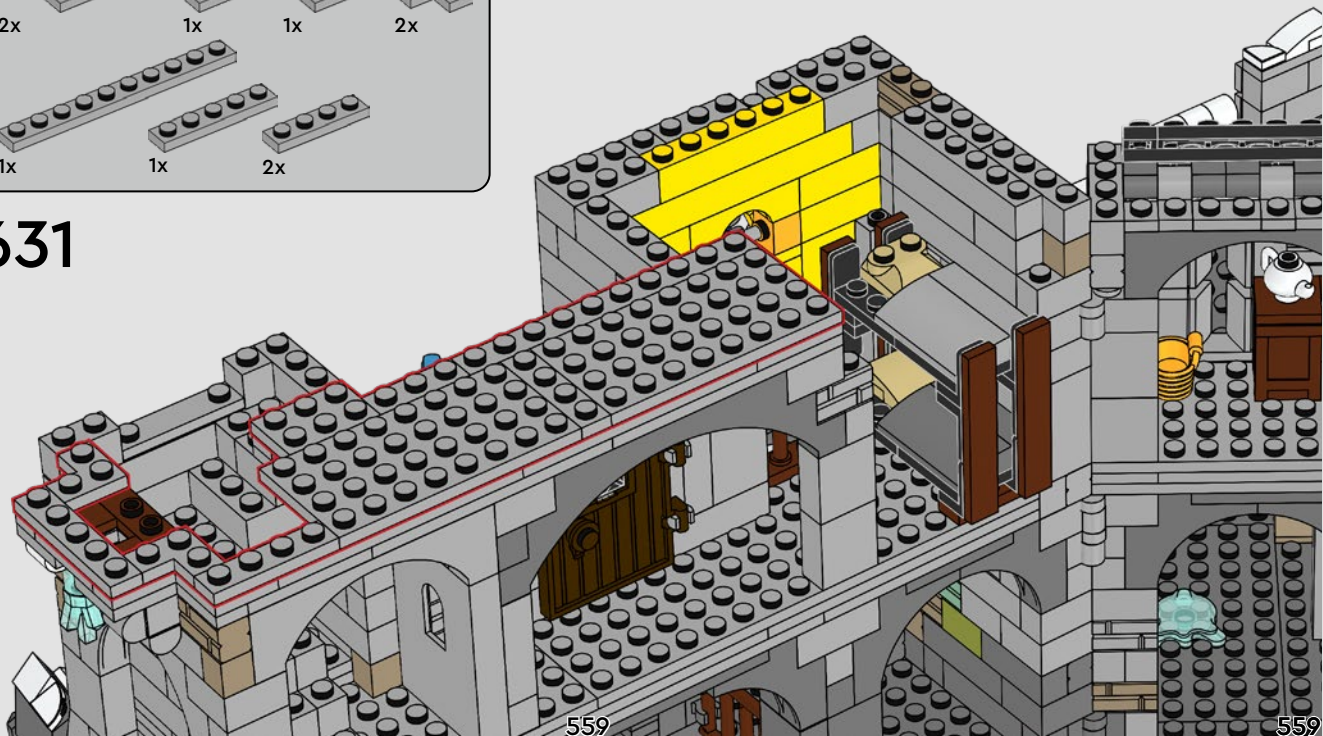





1x



1x

632

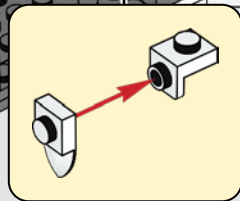
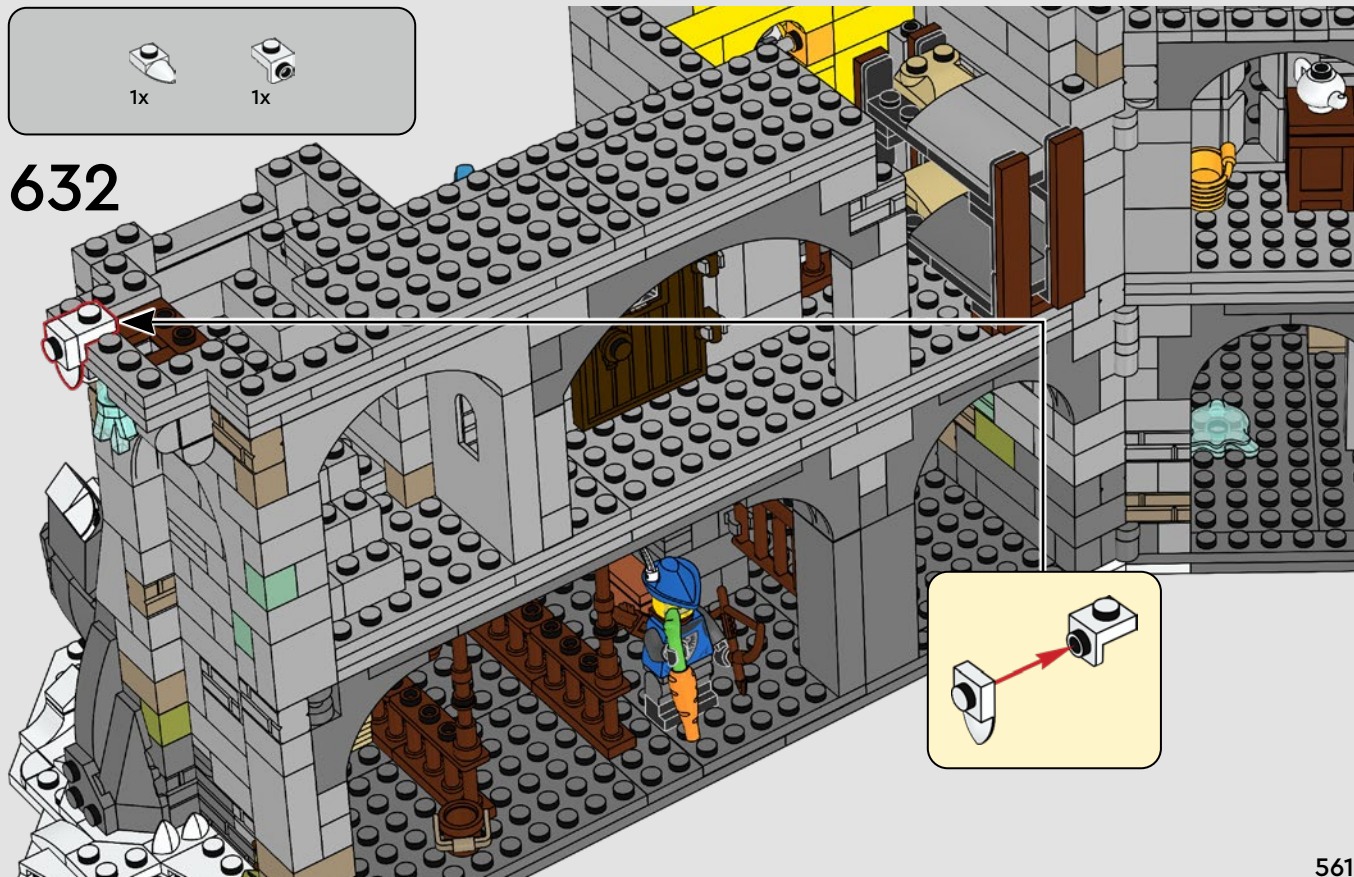

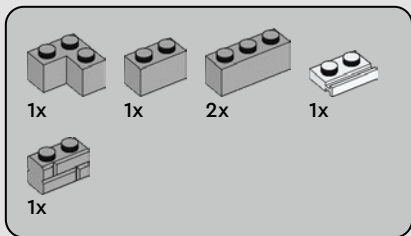

633

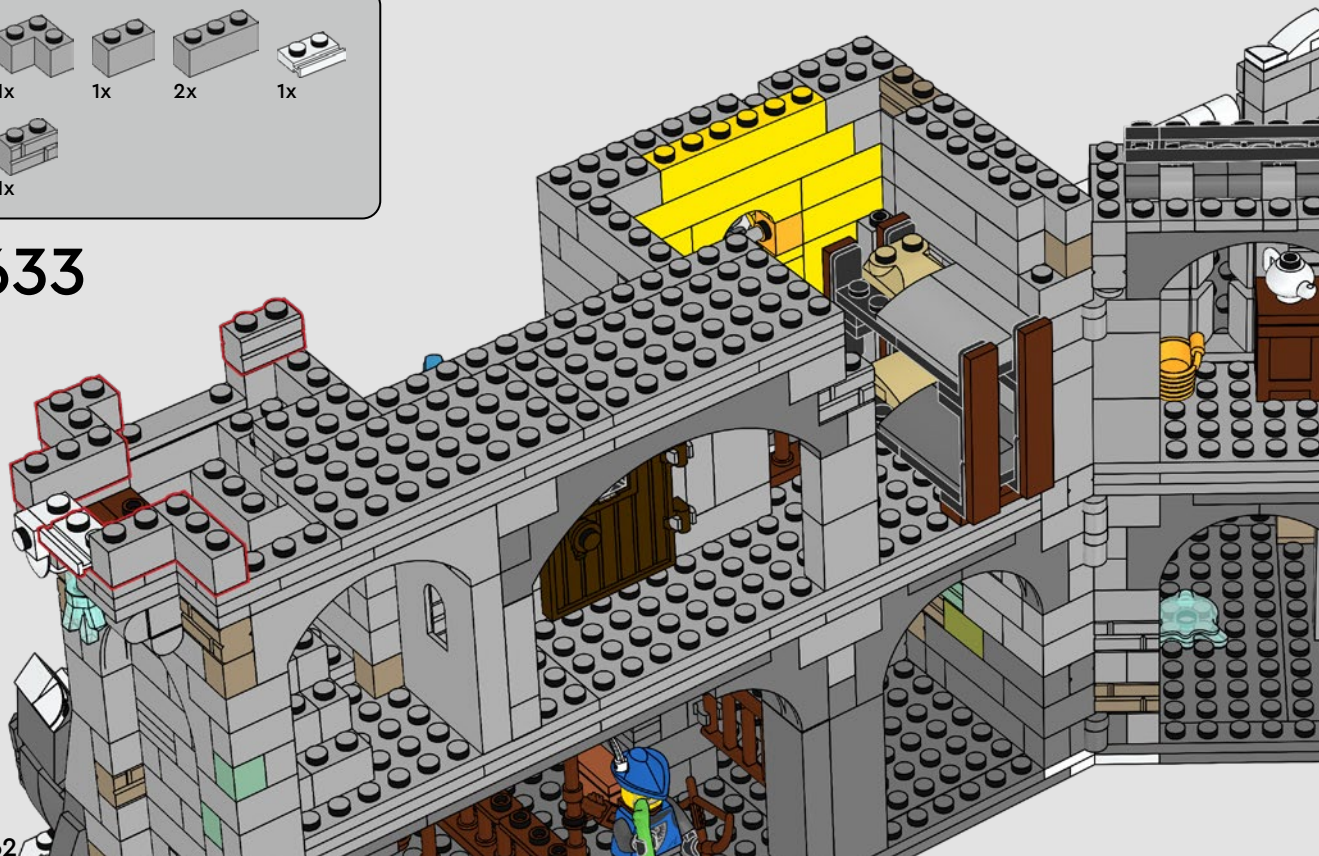

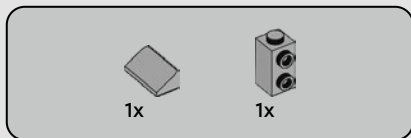

634





1x



1x

635

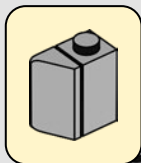

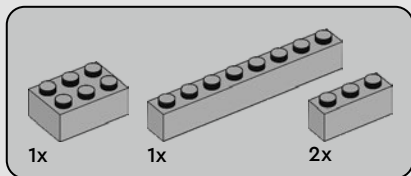

636

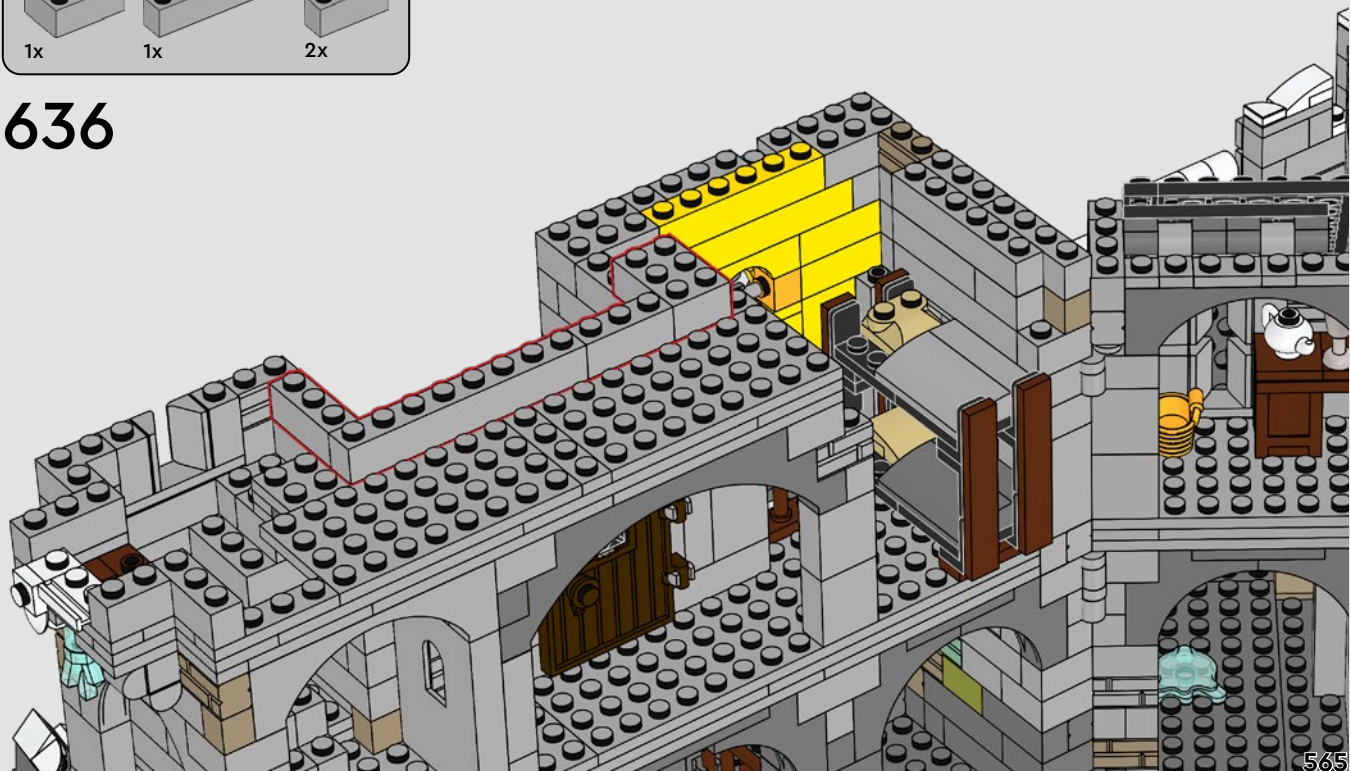

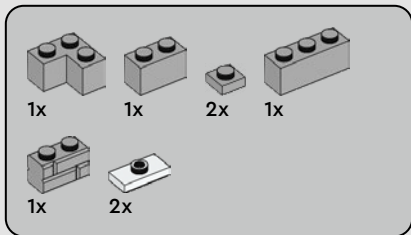

637

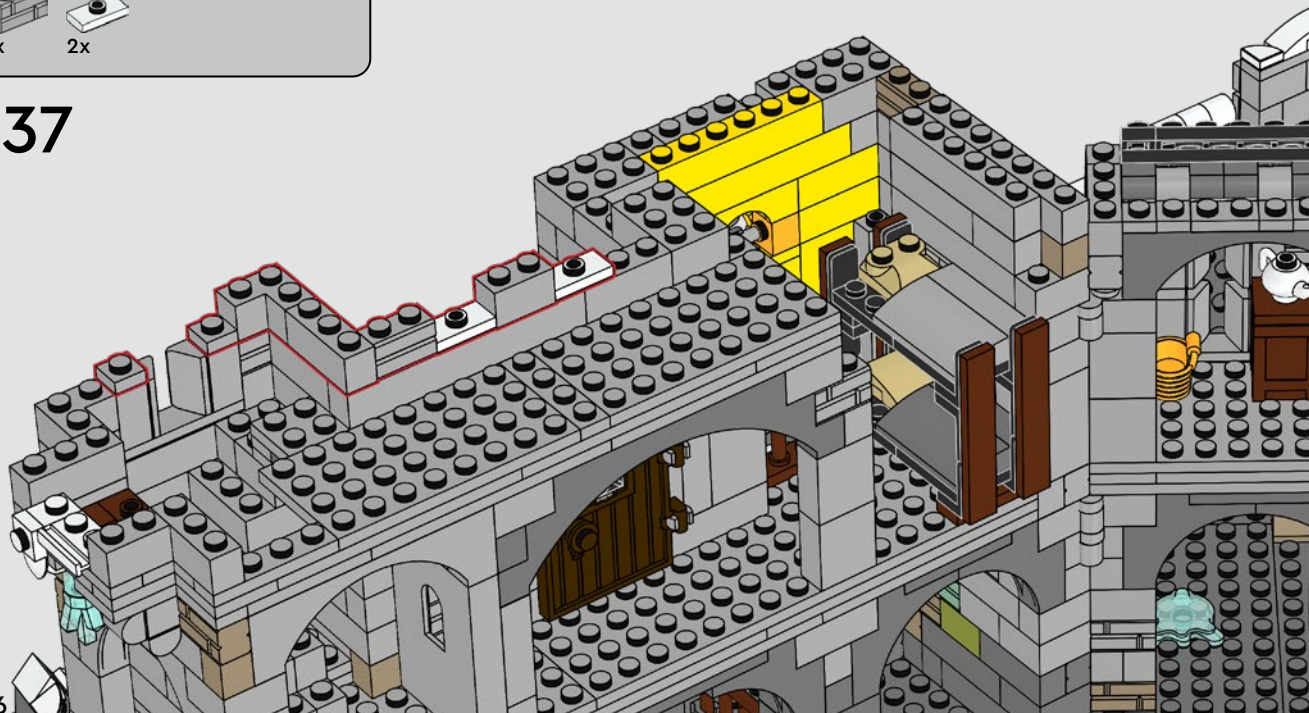

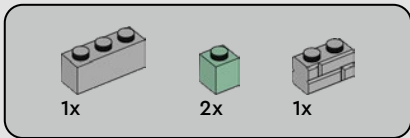

638

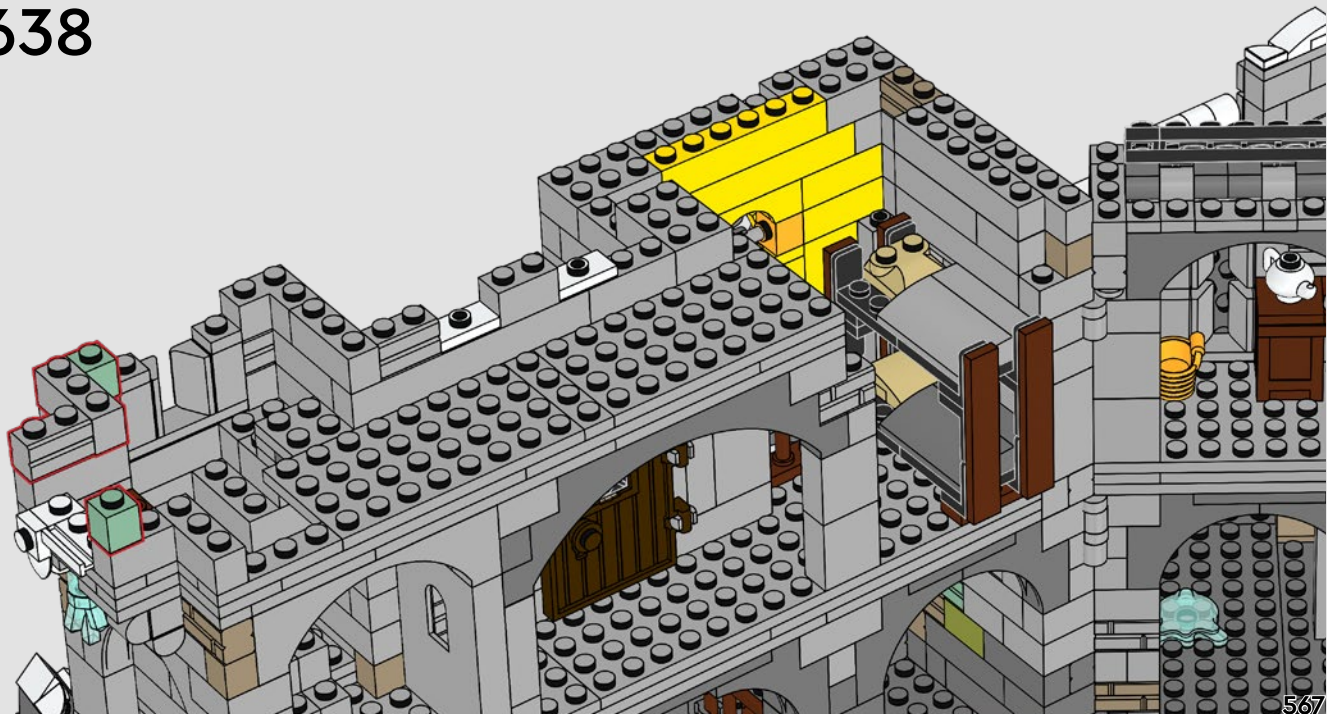



2x



2x

639



2x

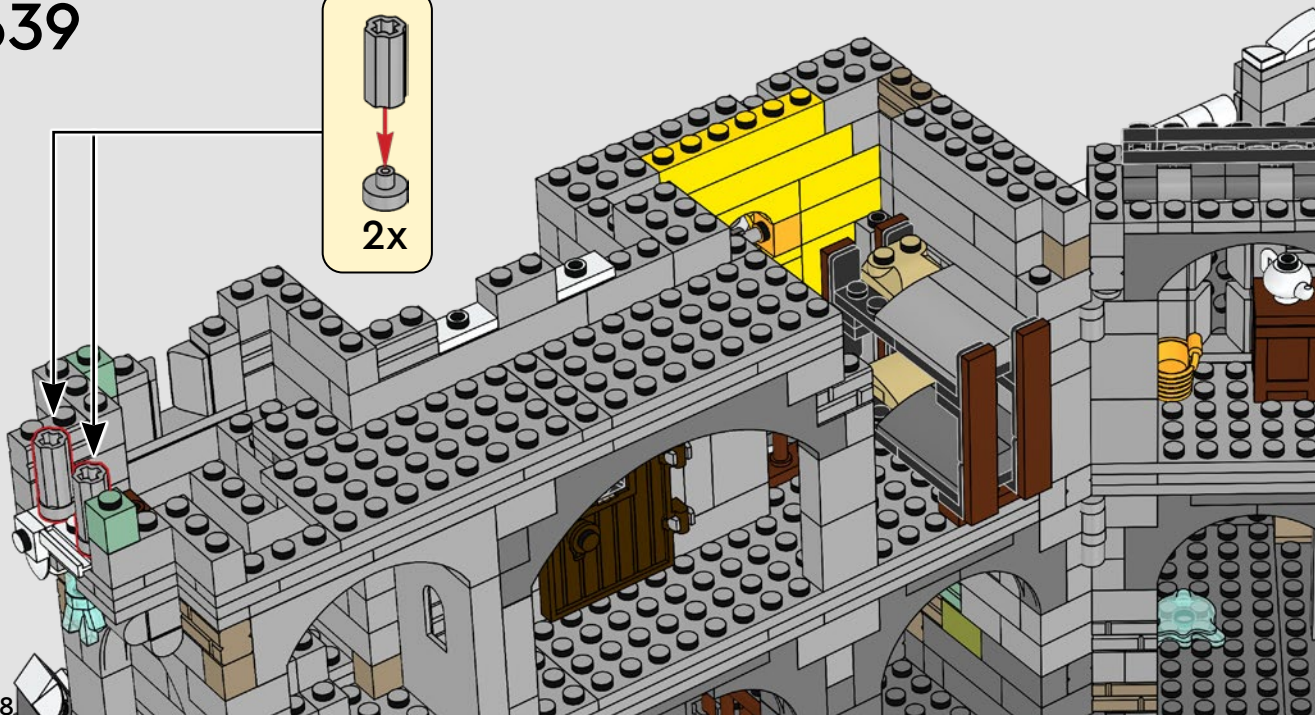

1x



2x



640

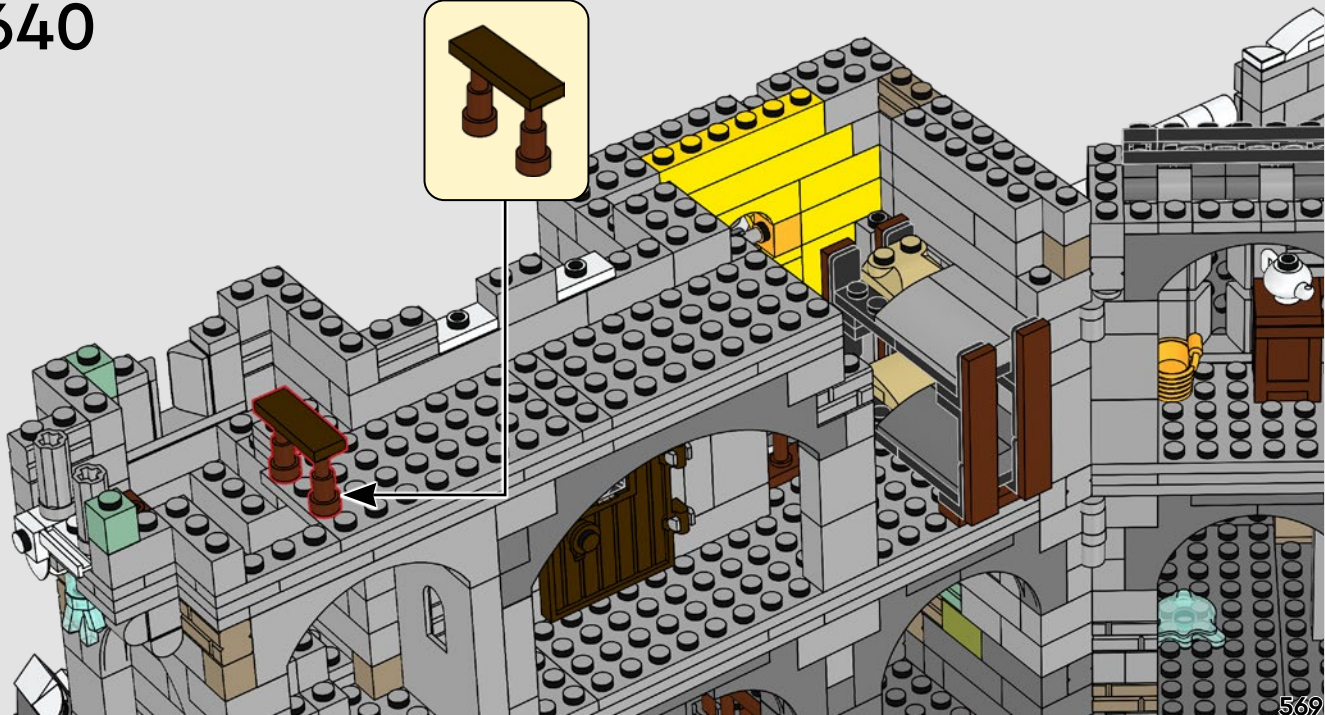
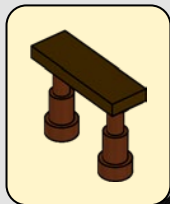

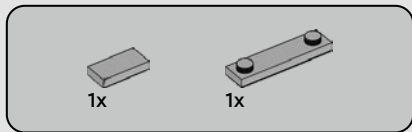

641

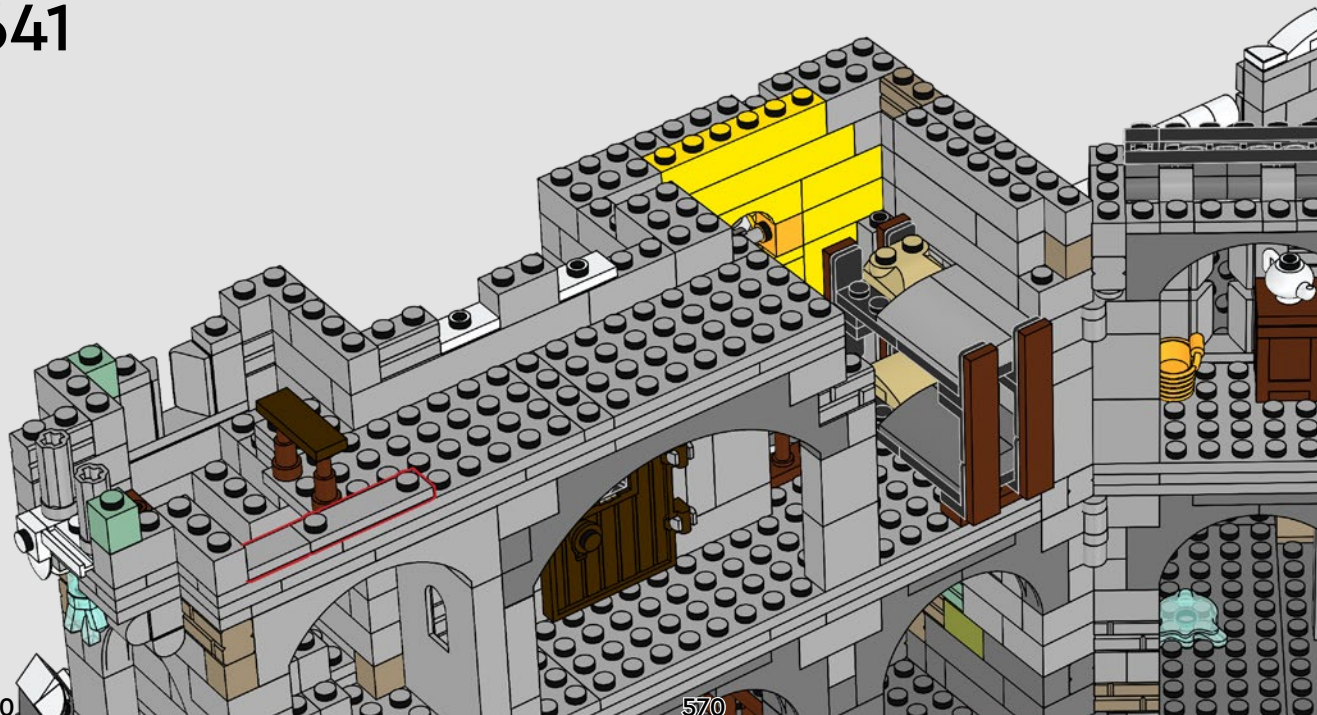

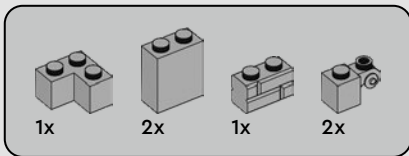

642

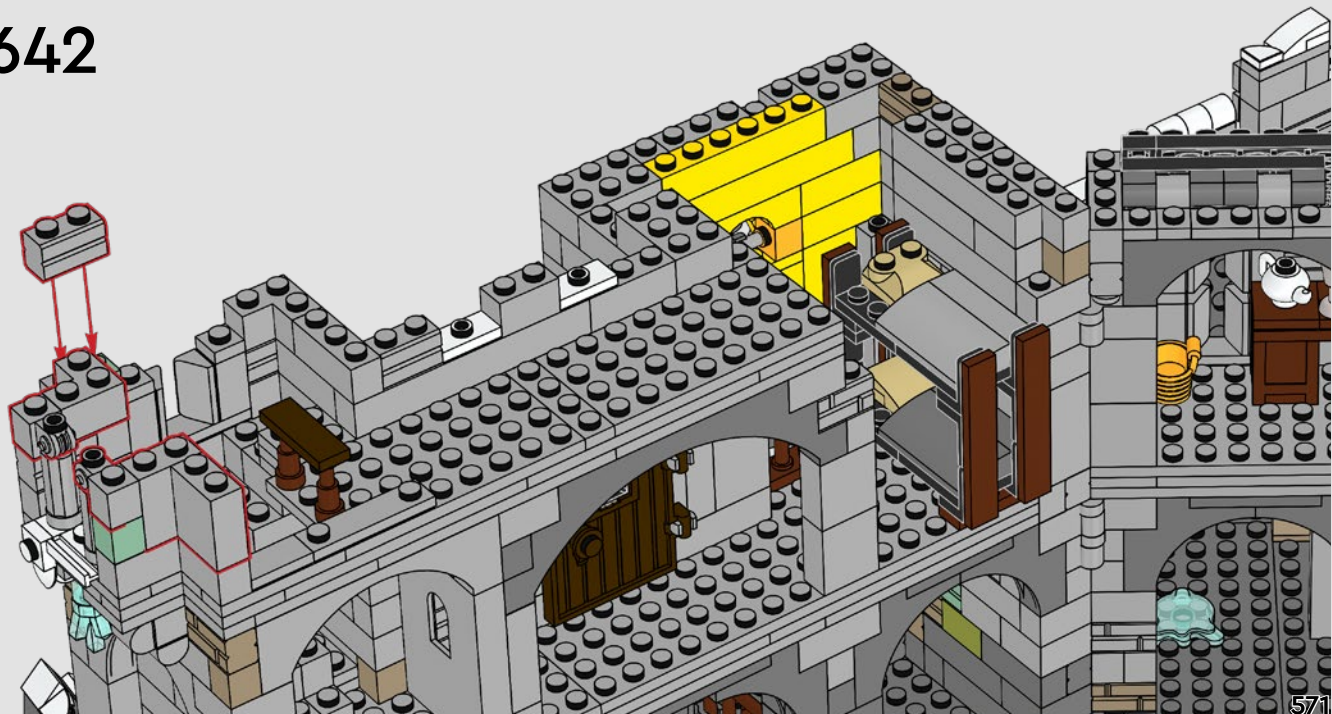



1x



2x

643

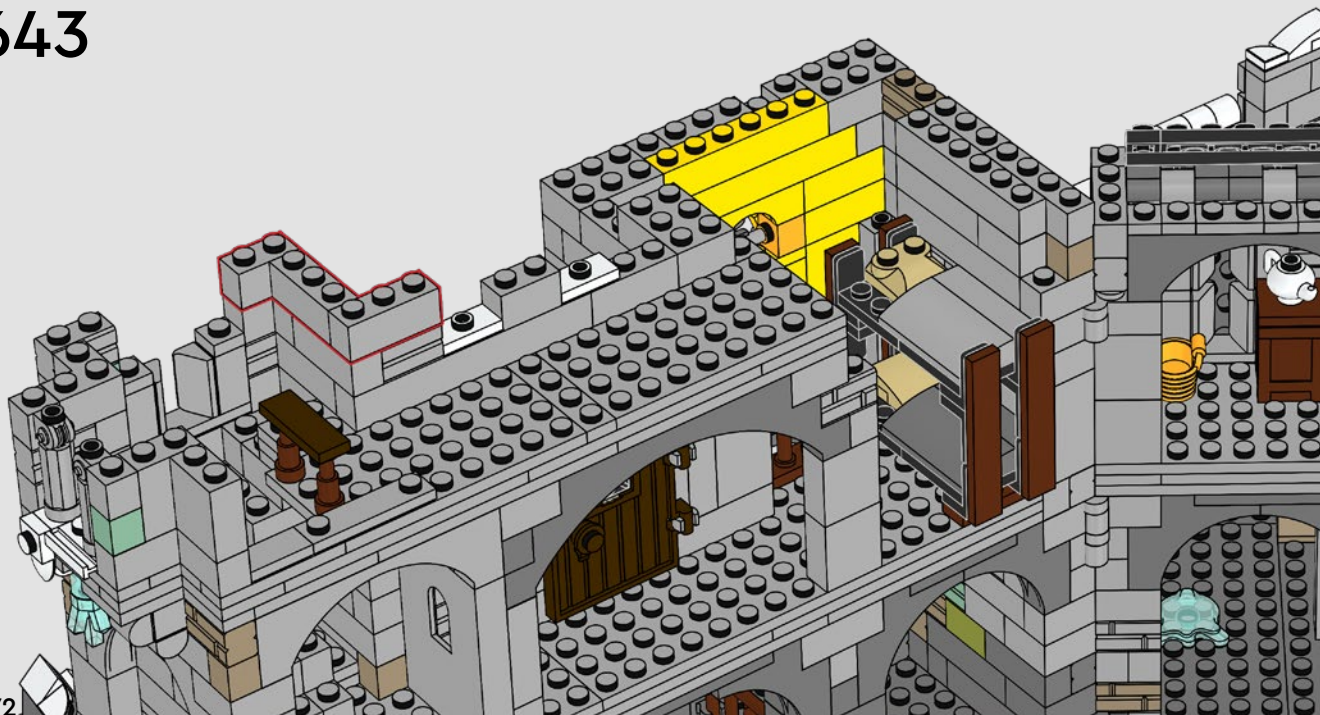



1x



1x

644

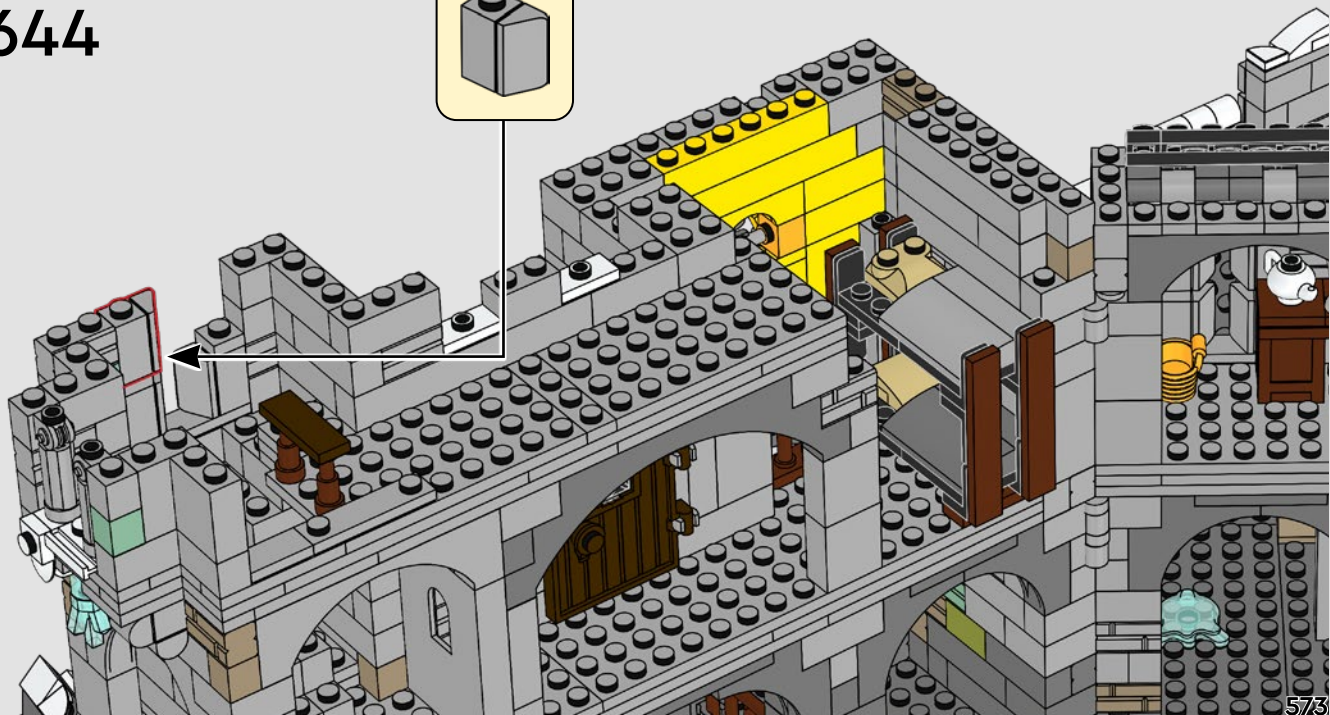
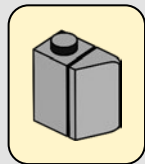



1x



1x

645

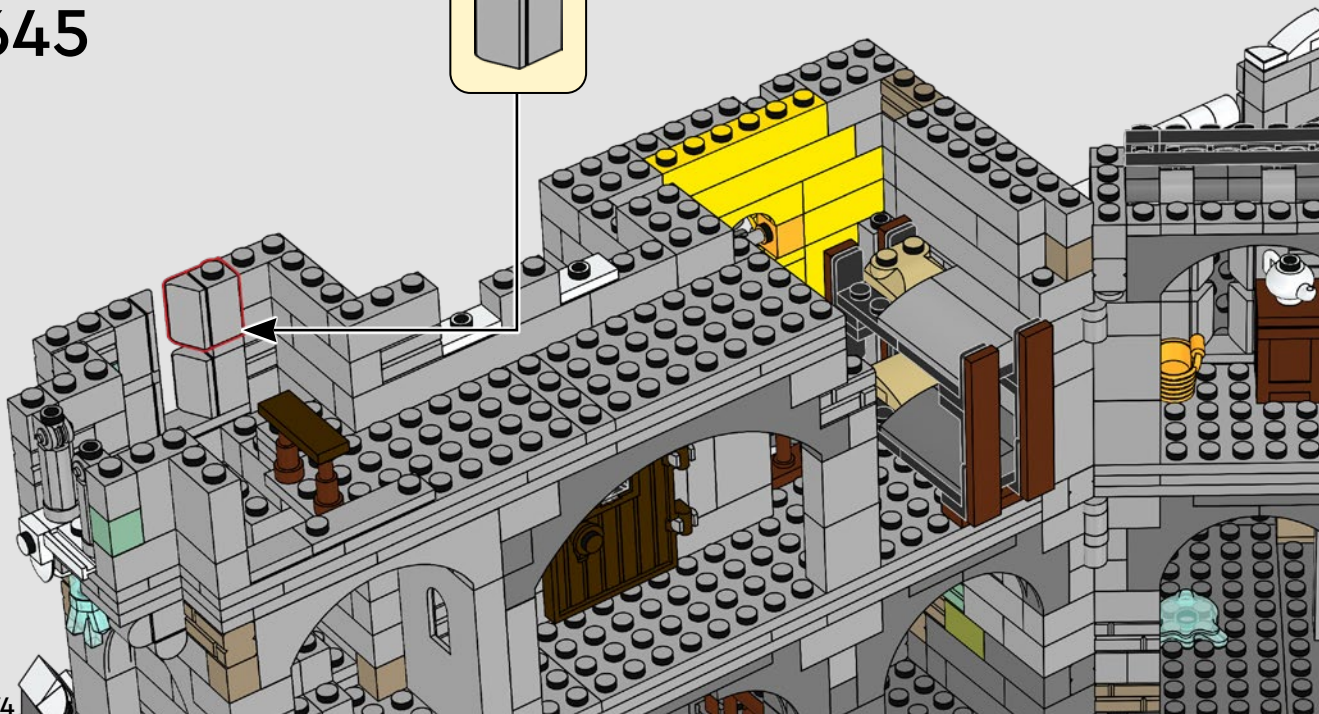
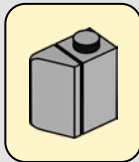

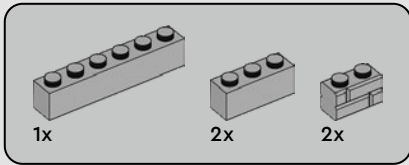

646

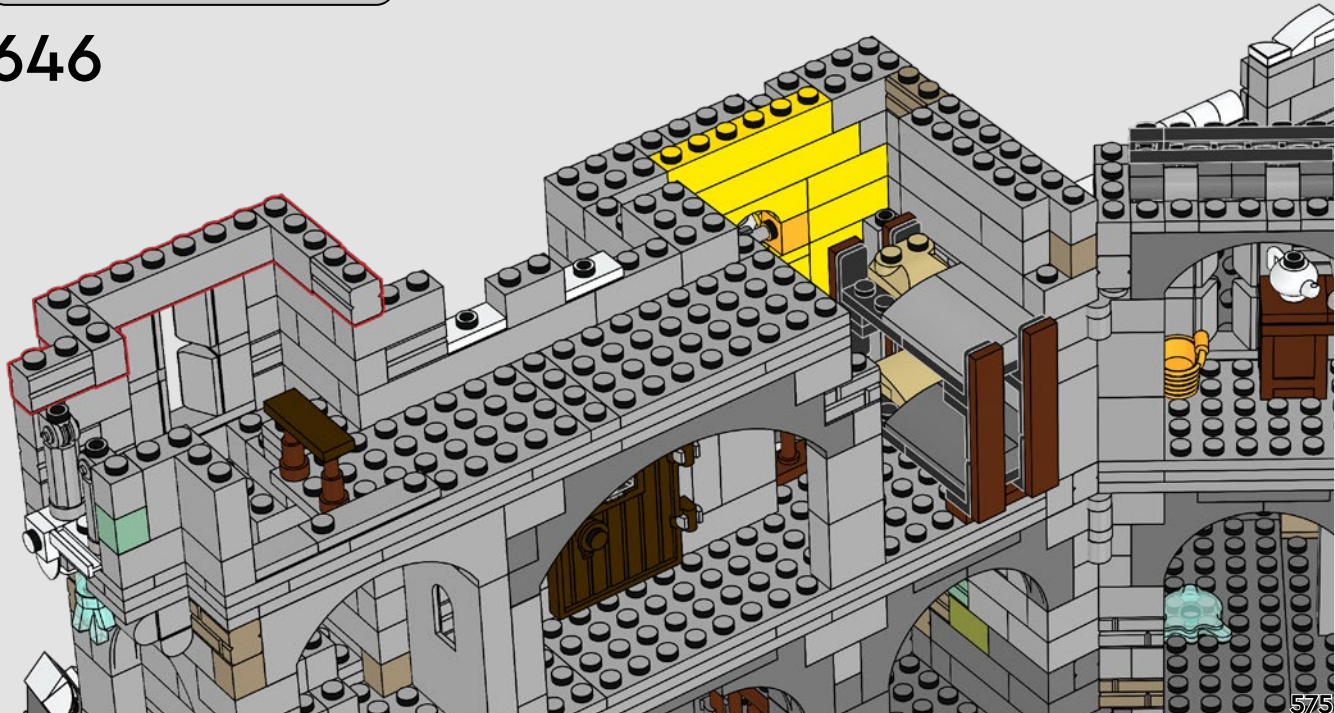

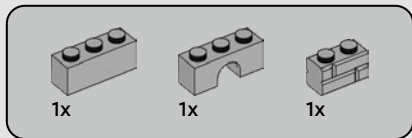

647

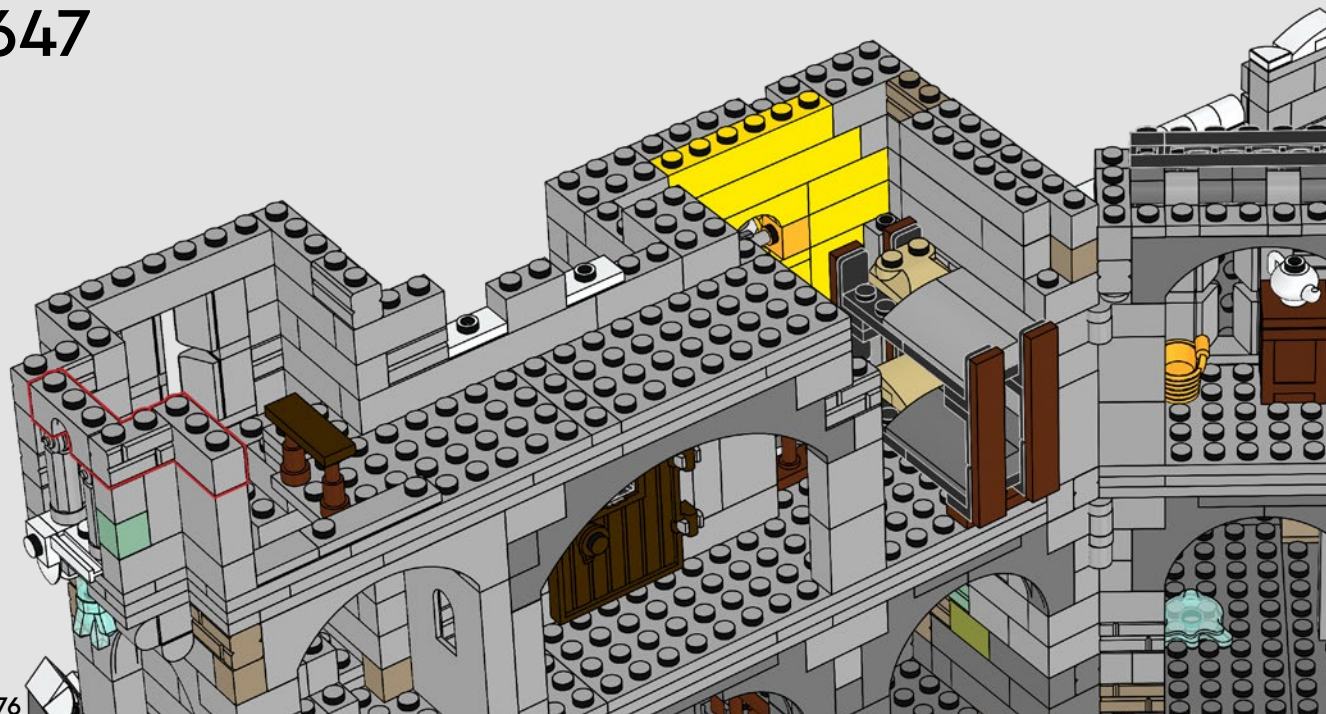

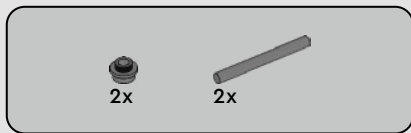

648

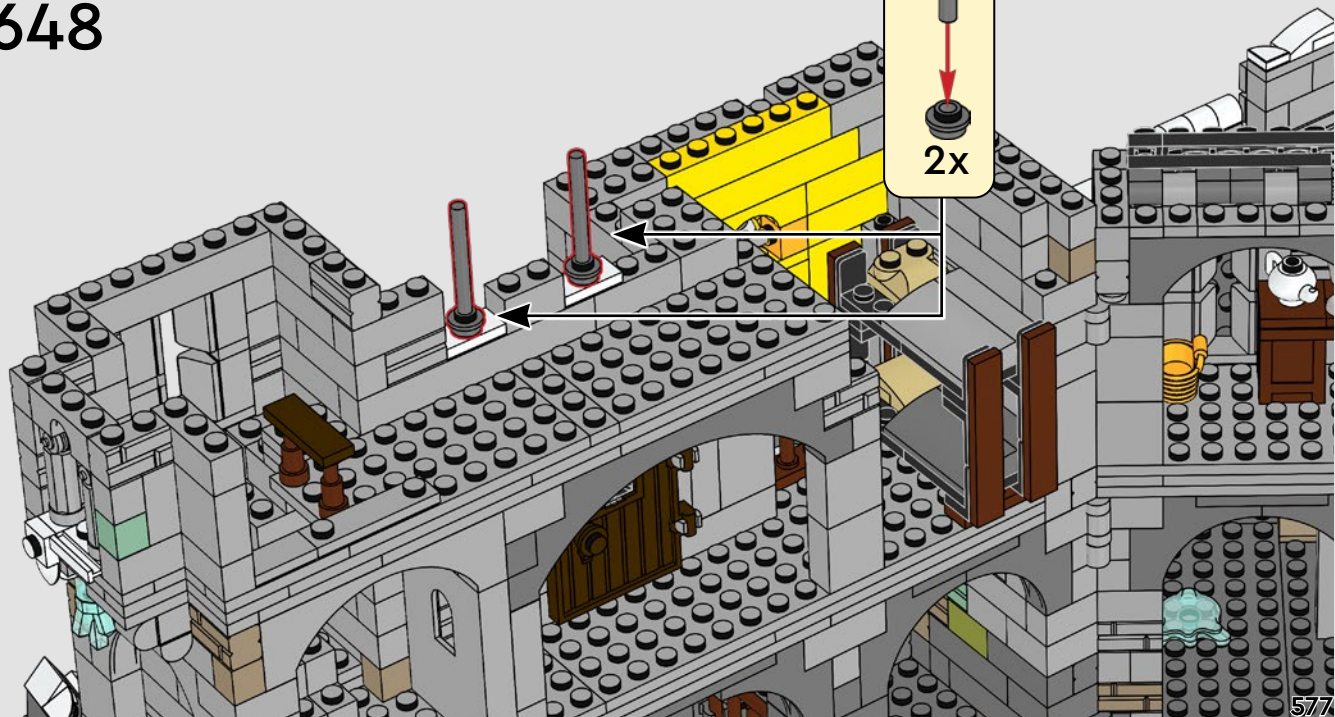
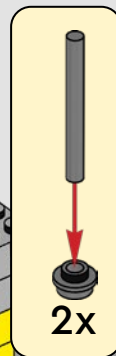



2x



1x

1 2

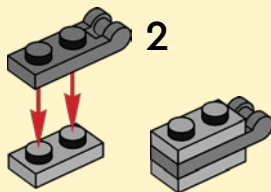

649

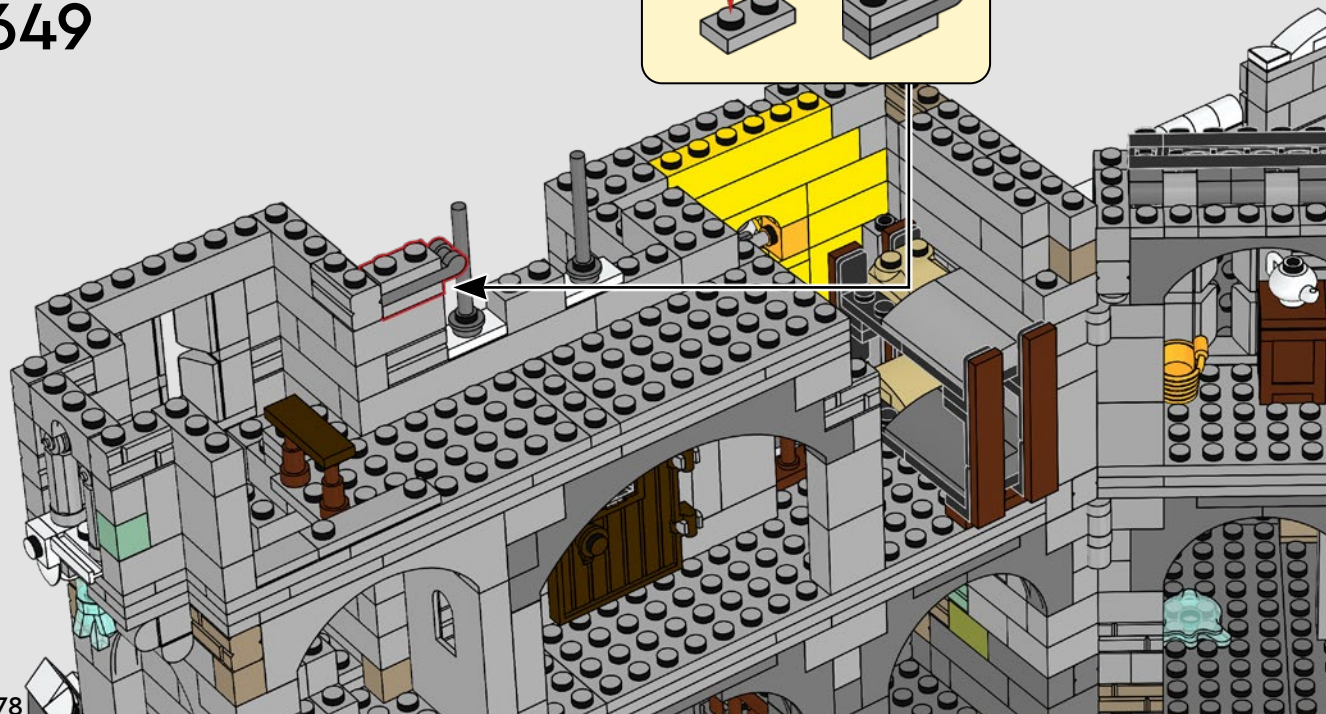

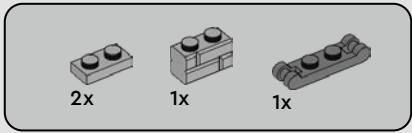

650

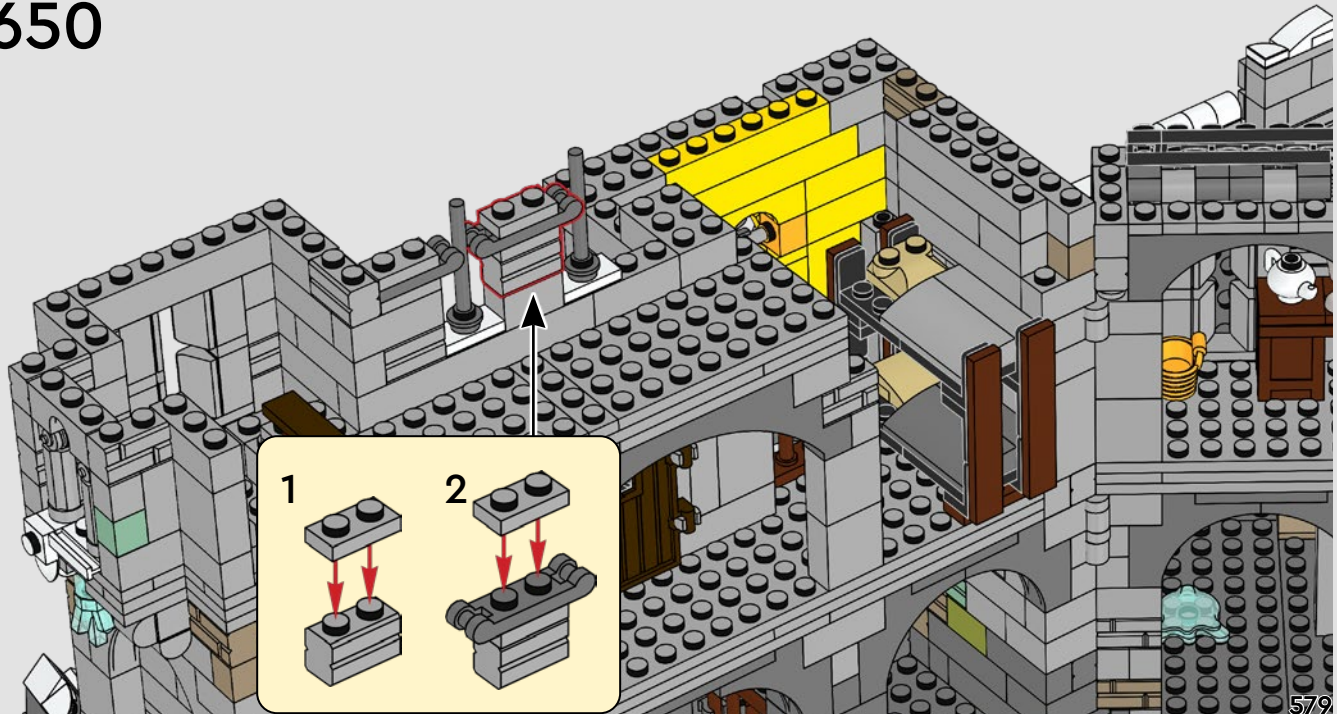

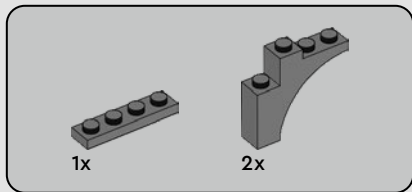

651

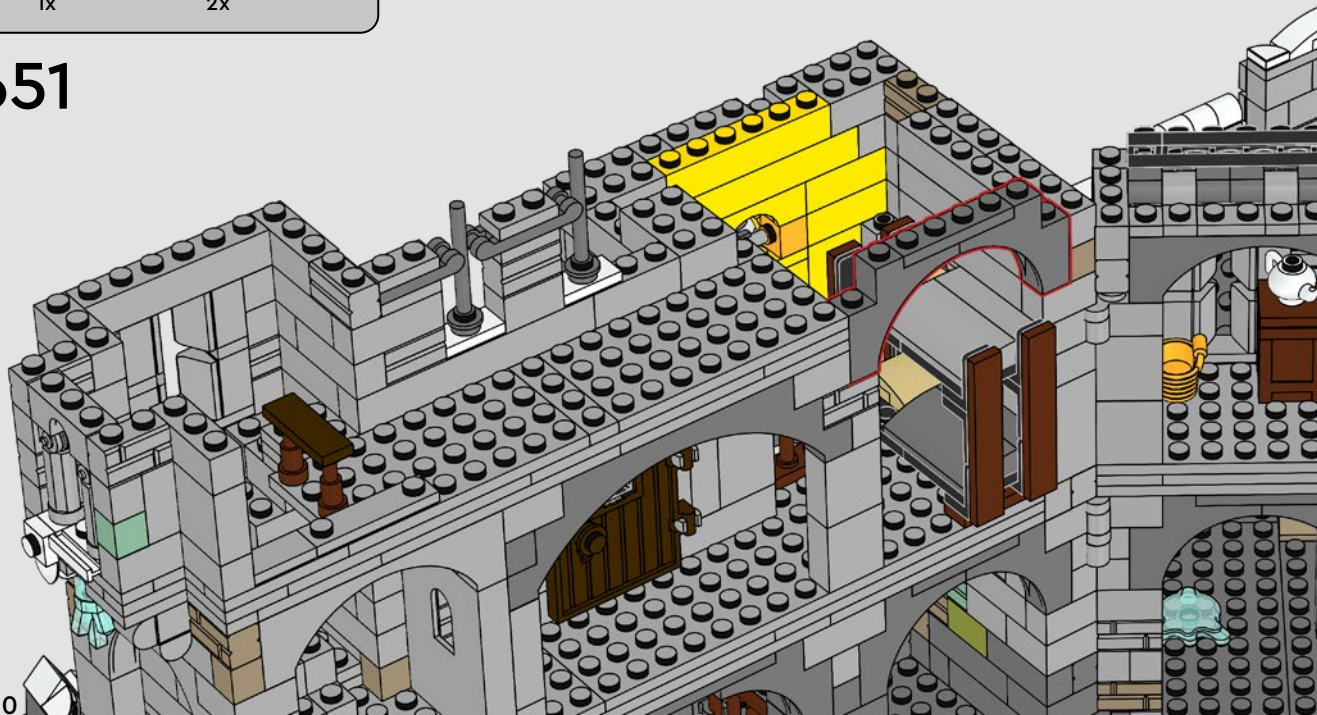

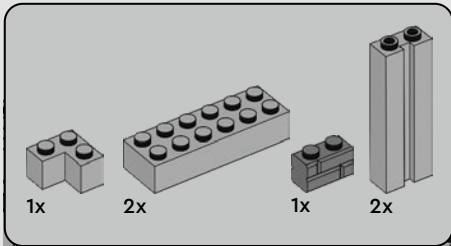

652

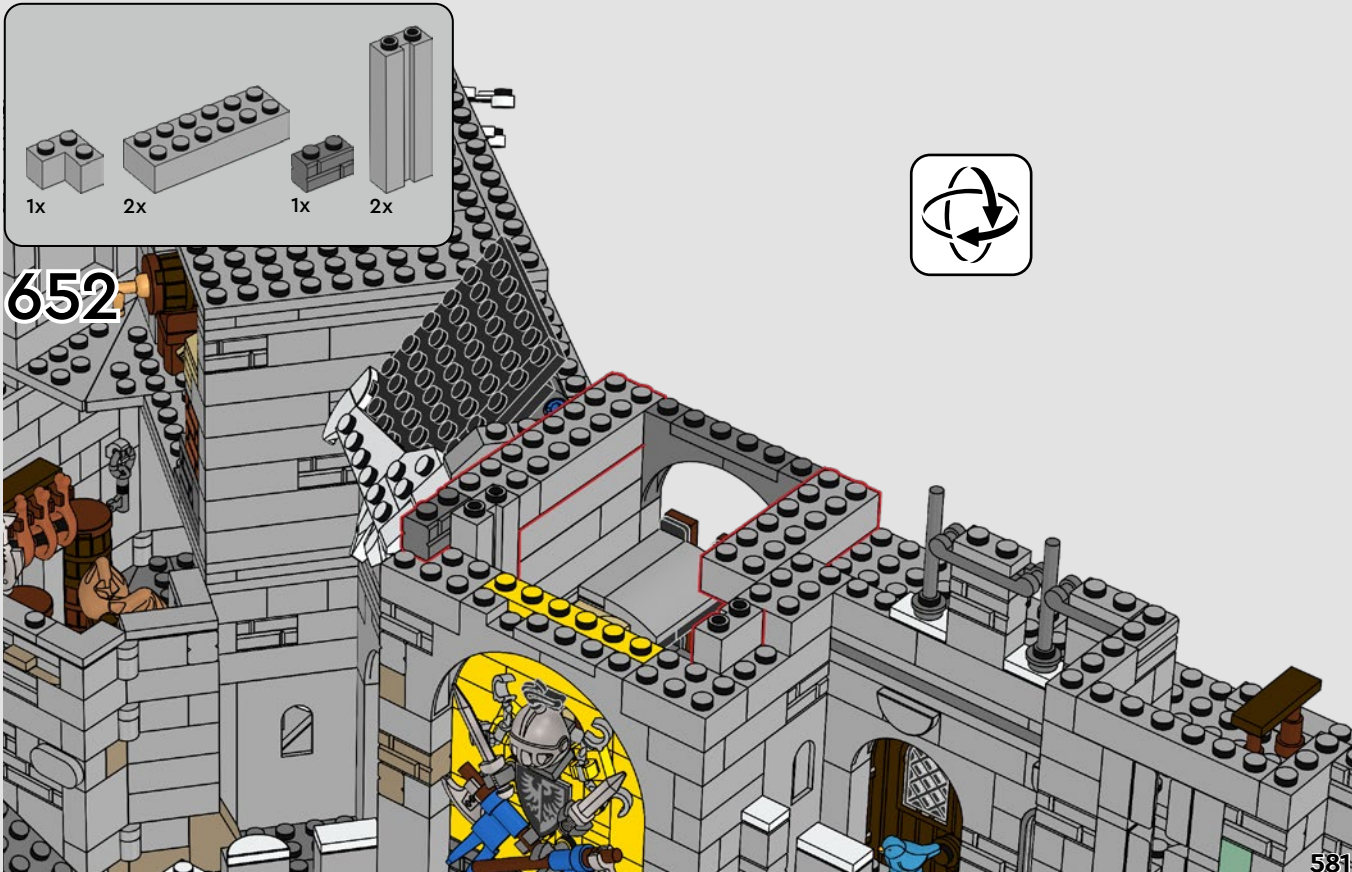



2x



1x



5x

653

582





1x



1x

654

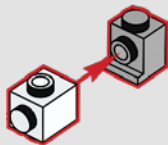

1x

655



1x



1x

656



657



584



3x

658

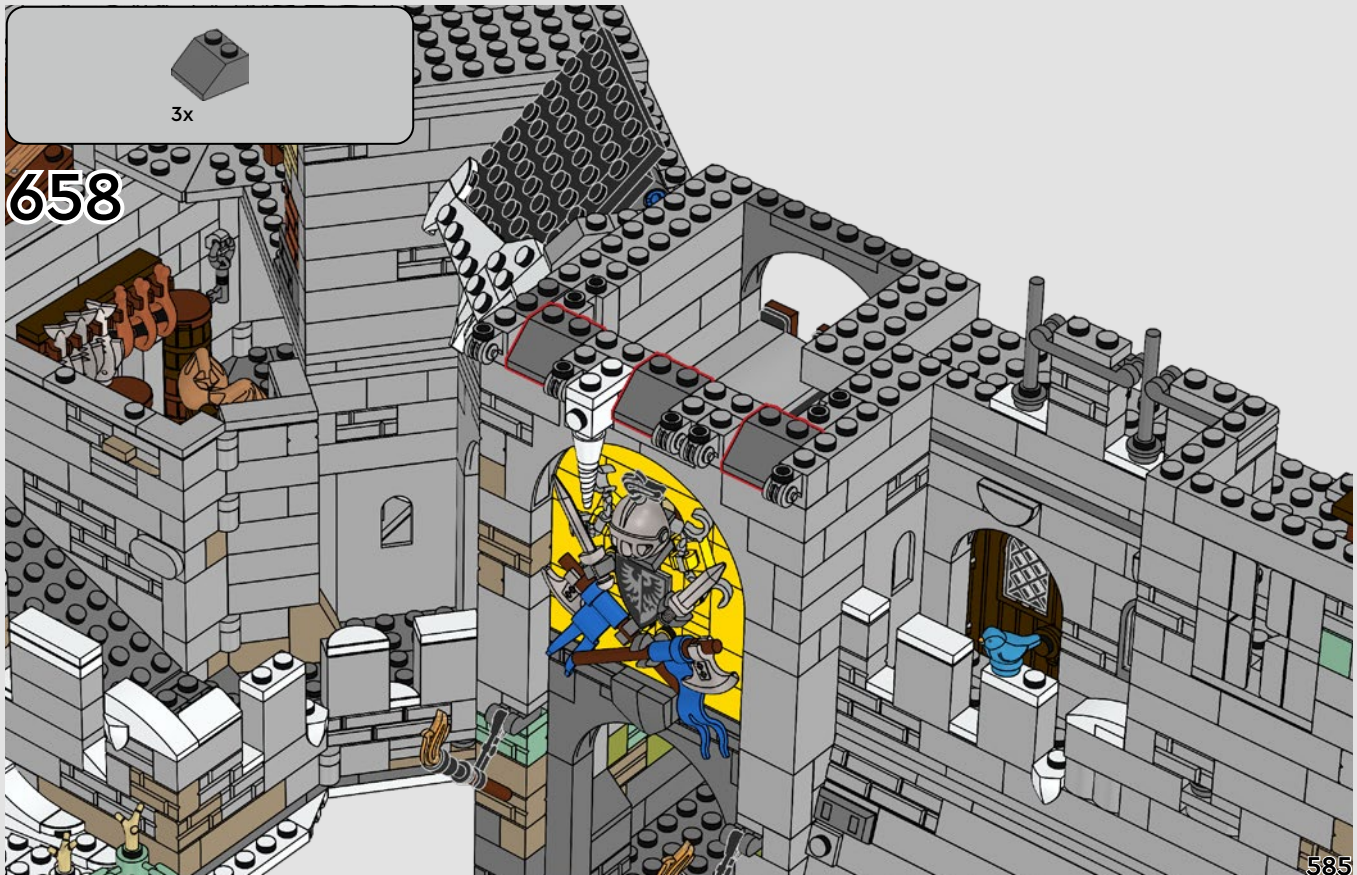

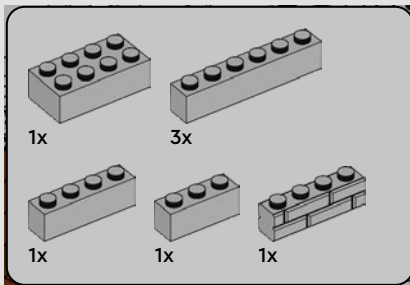

659

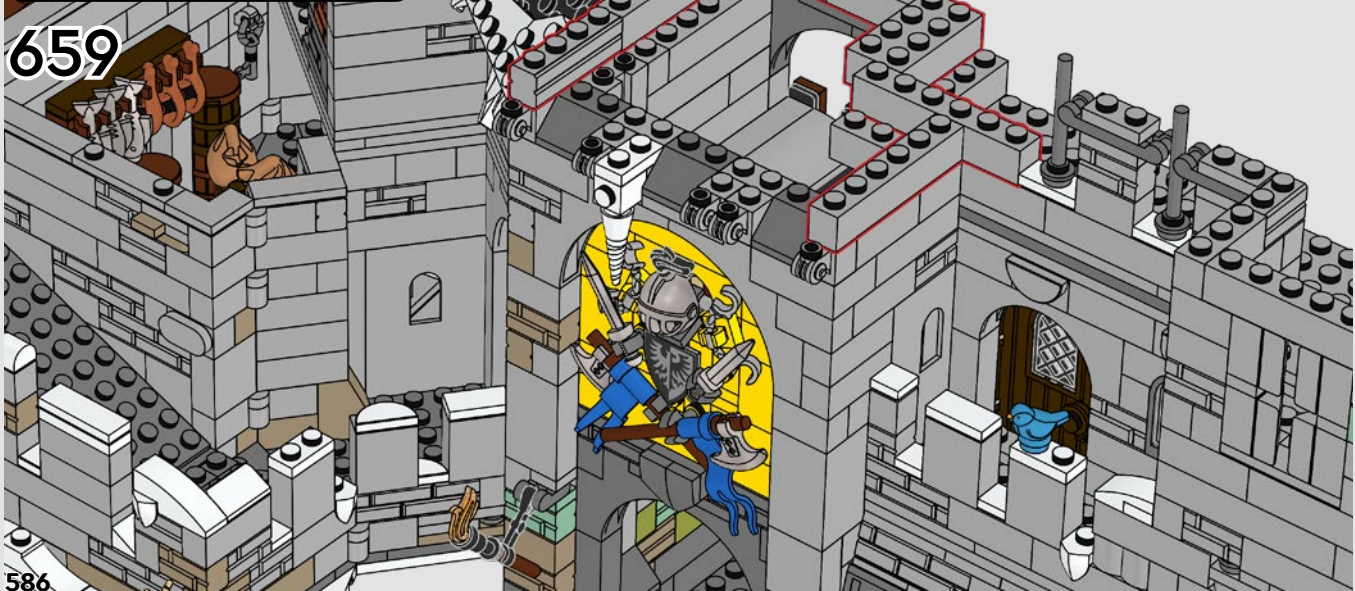



660

2x

1x

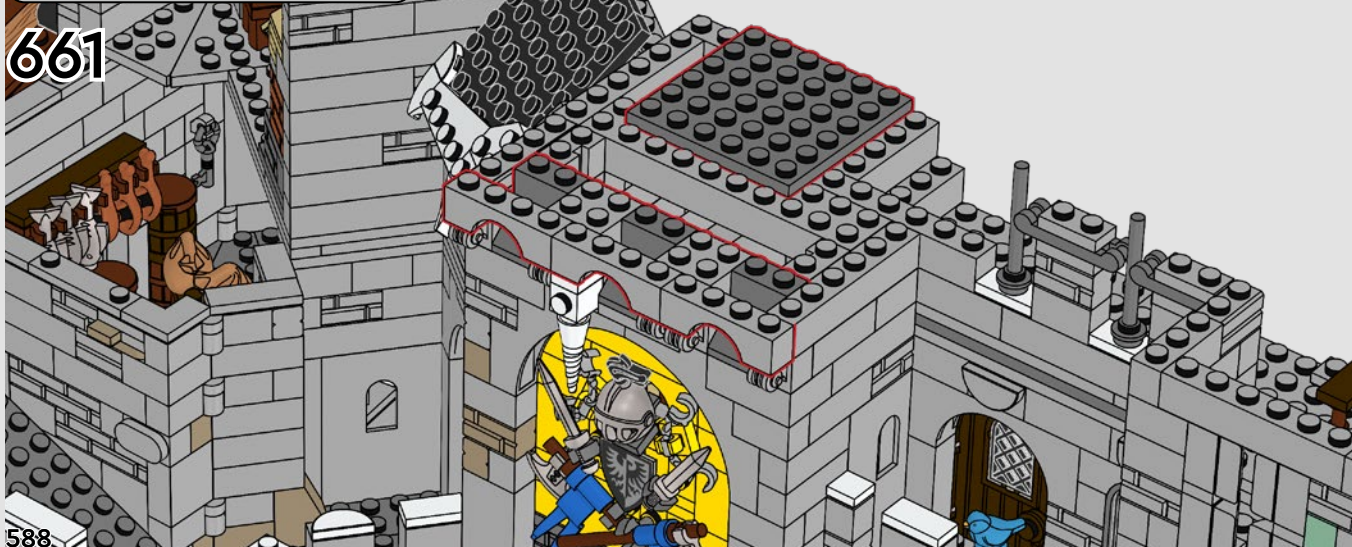
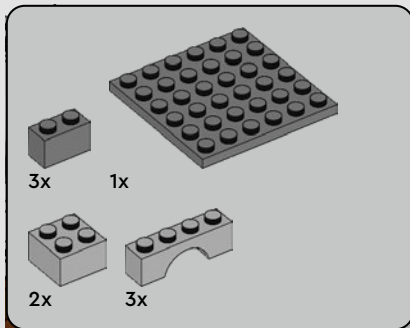

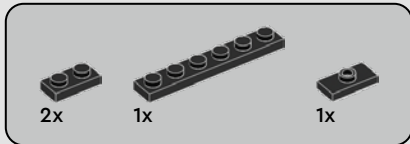
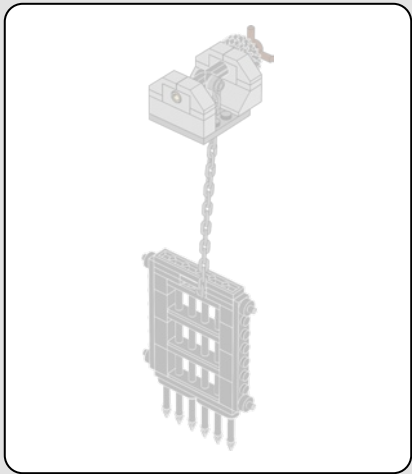

662

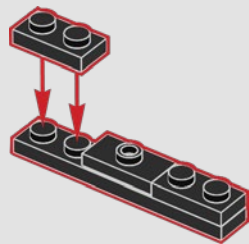

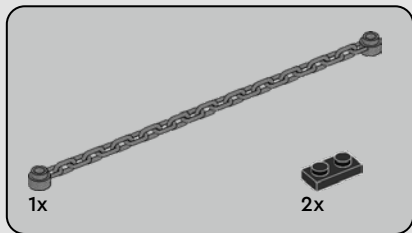

663

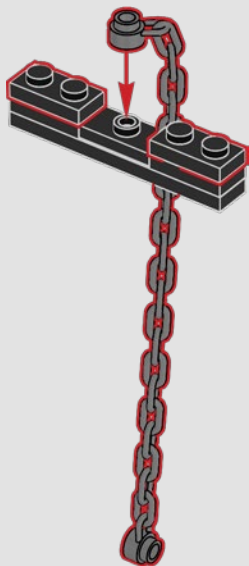

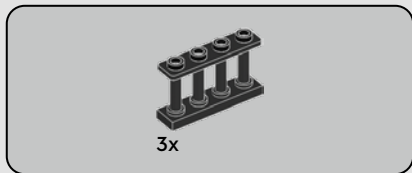

664

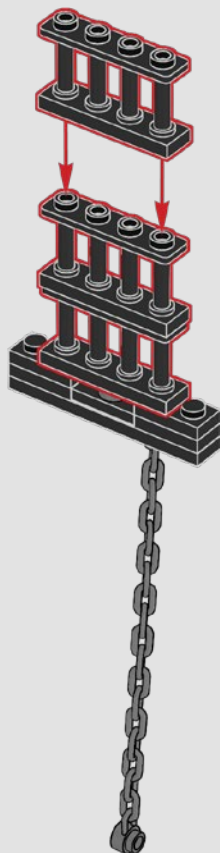



2x



6x

665

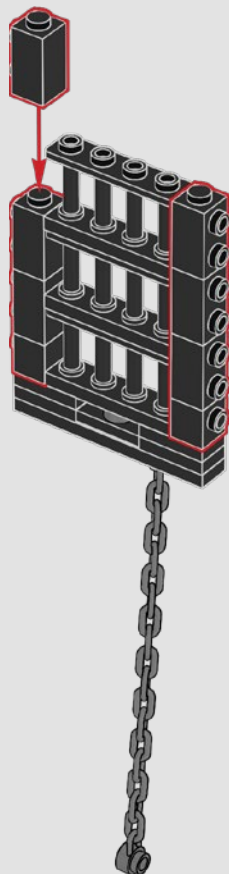

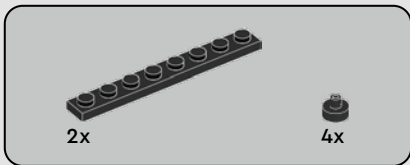

666

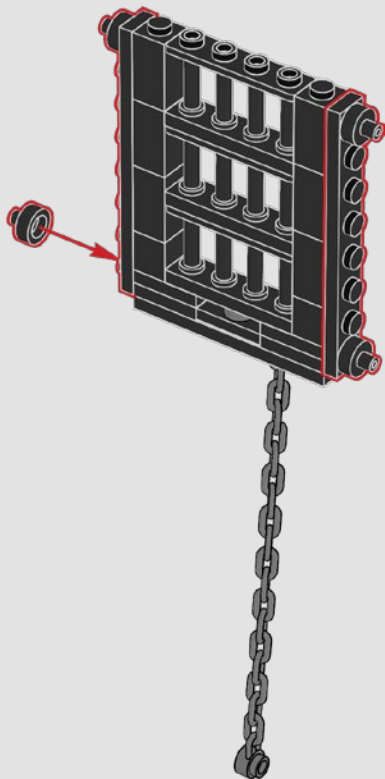

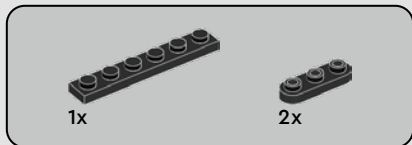

667

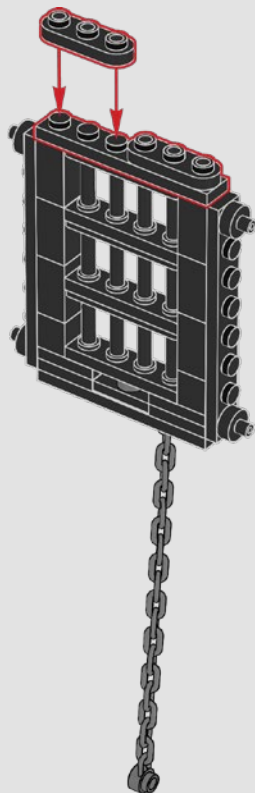

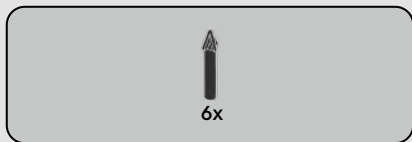

668

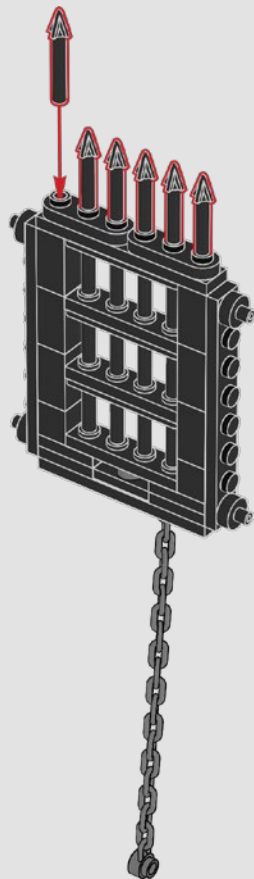

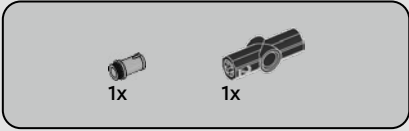
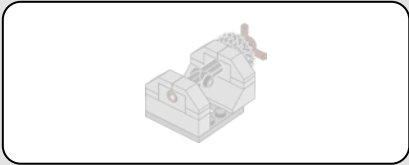

669

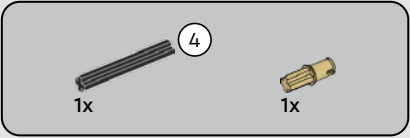
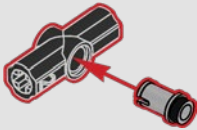

670

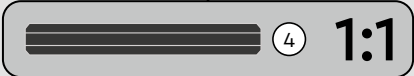
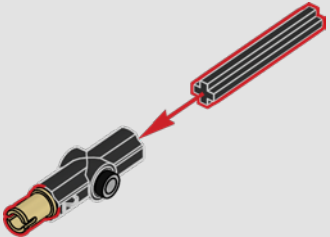



2x

671

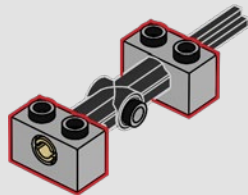

1x



1x

672

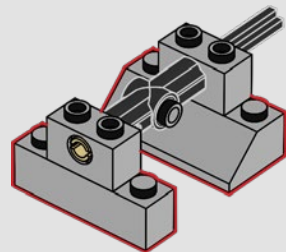

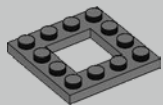

1x

673

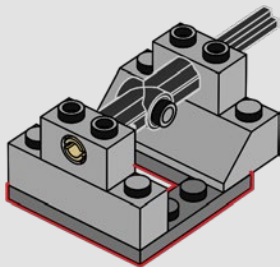

4x

674

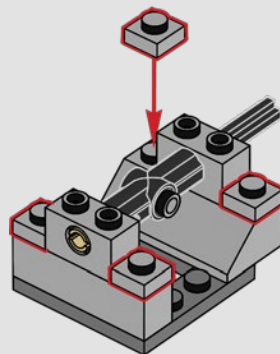



4x

675

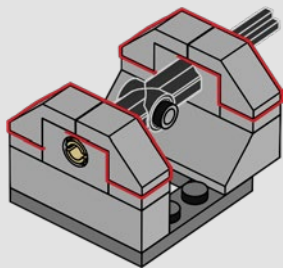

1x

676

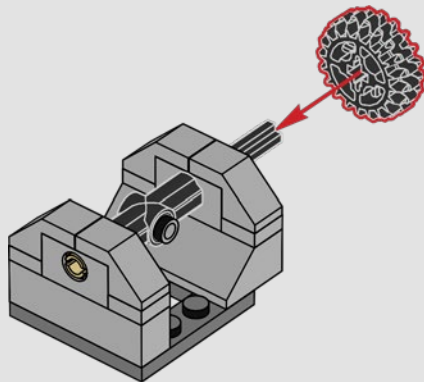



1x

677

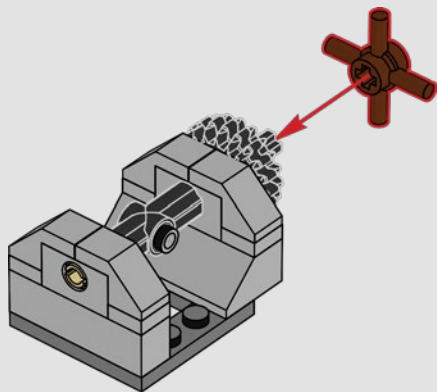

600

678

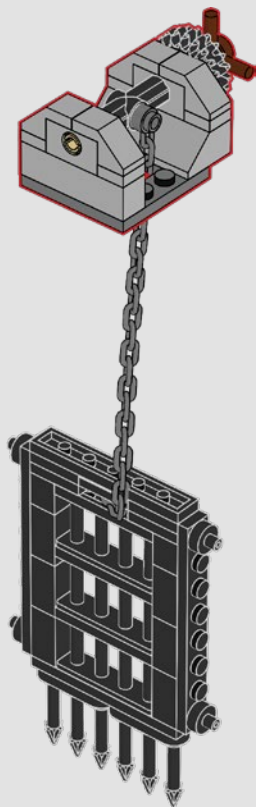

679



680



603

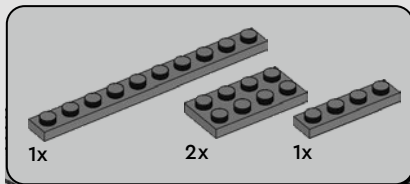

681

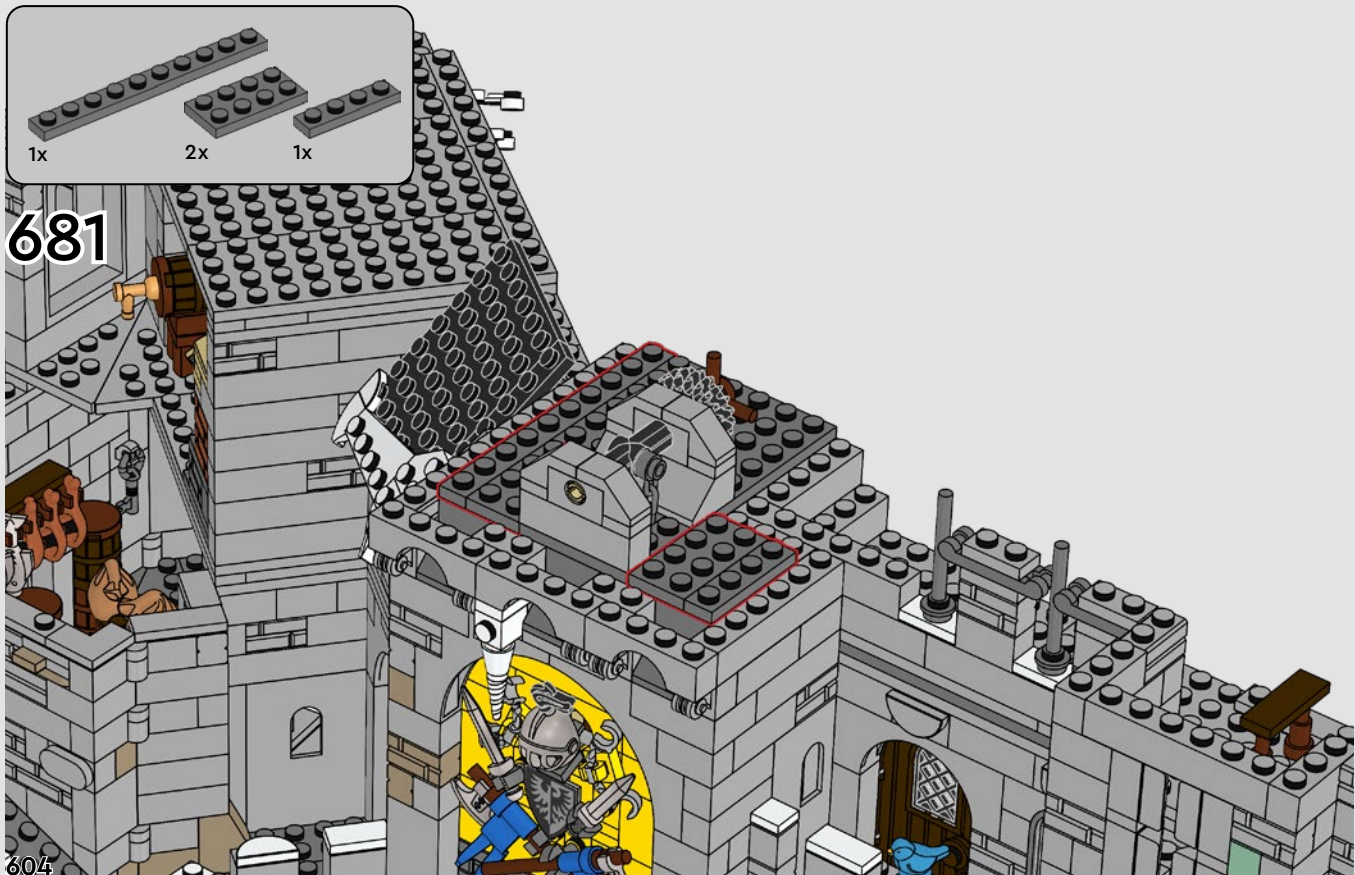

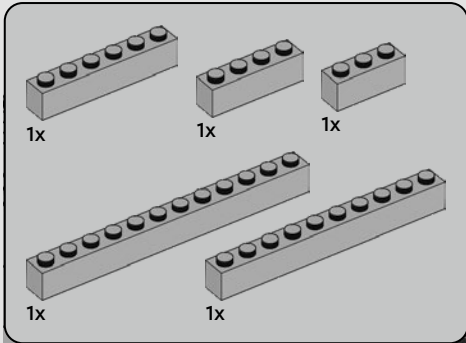

682





2x



1x

683

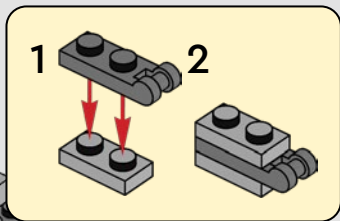

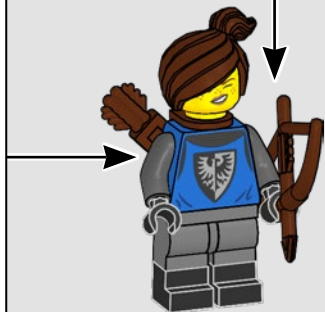
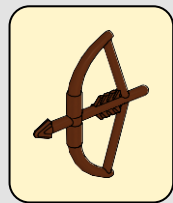
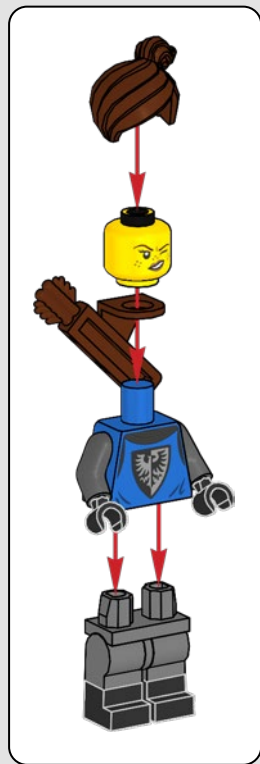



3x

684

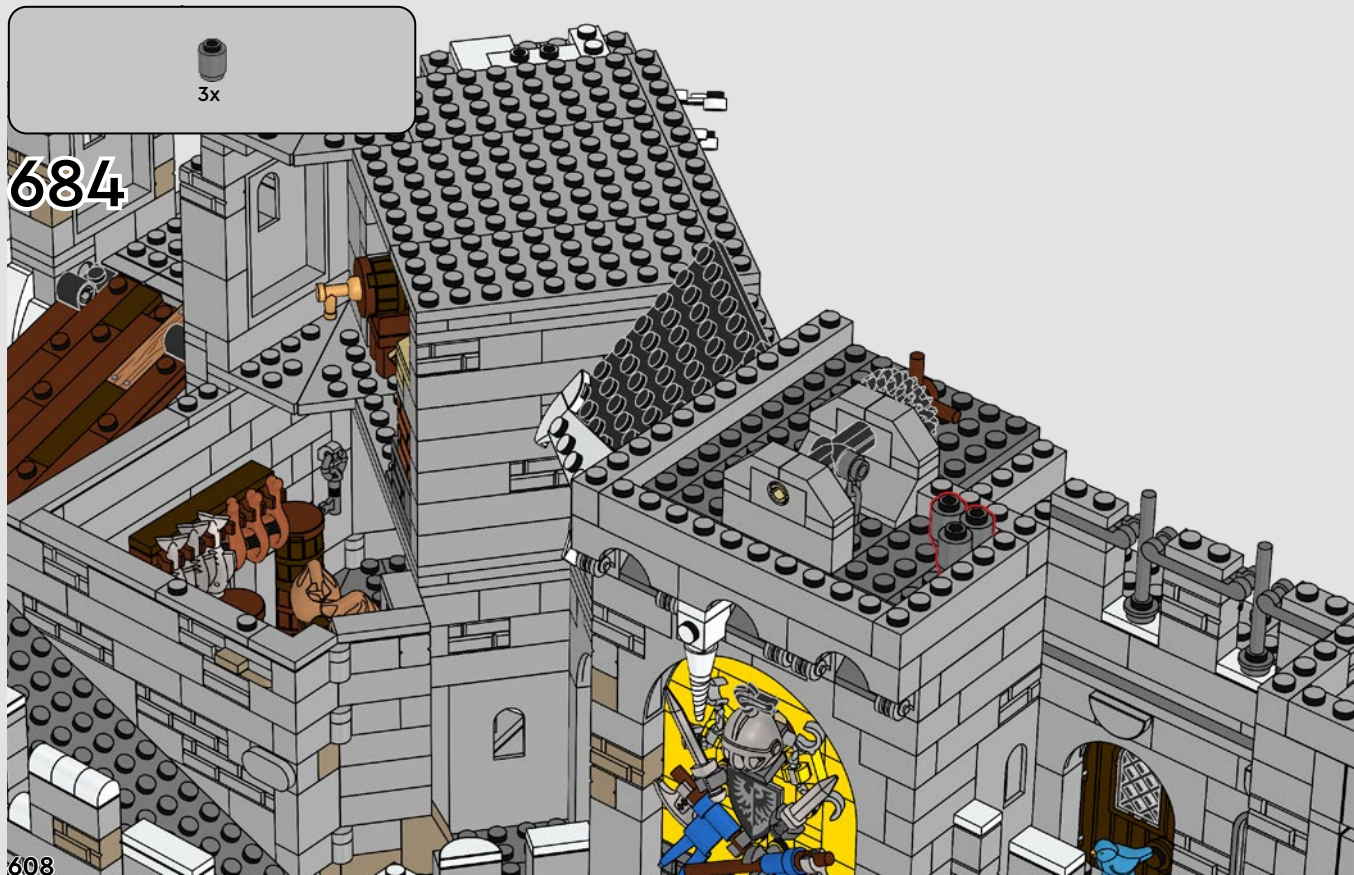



1x



3x



1x

685



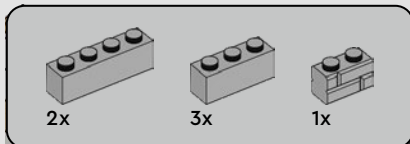

686

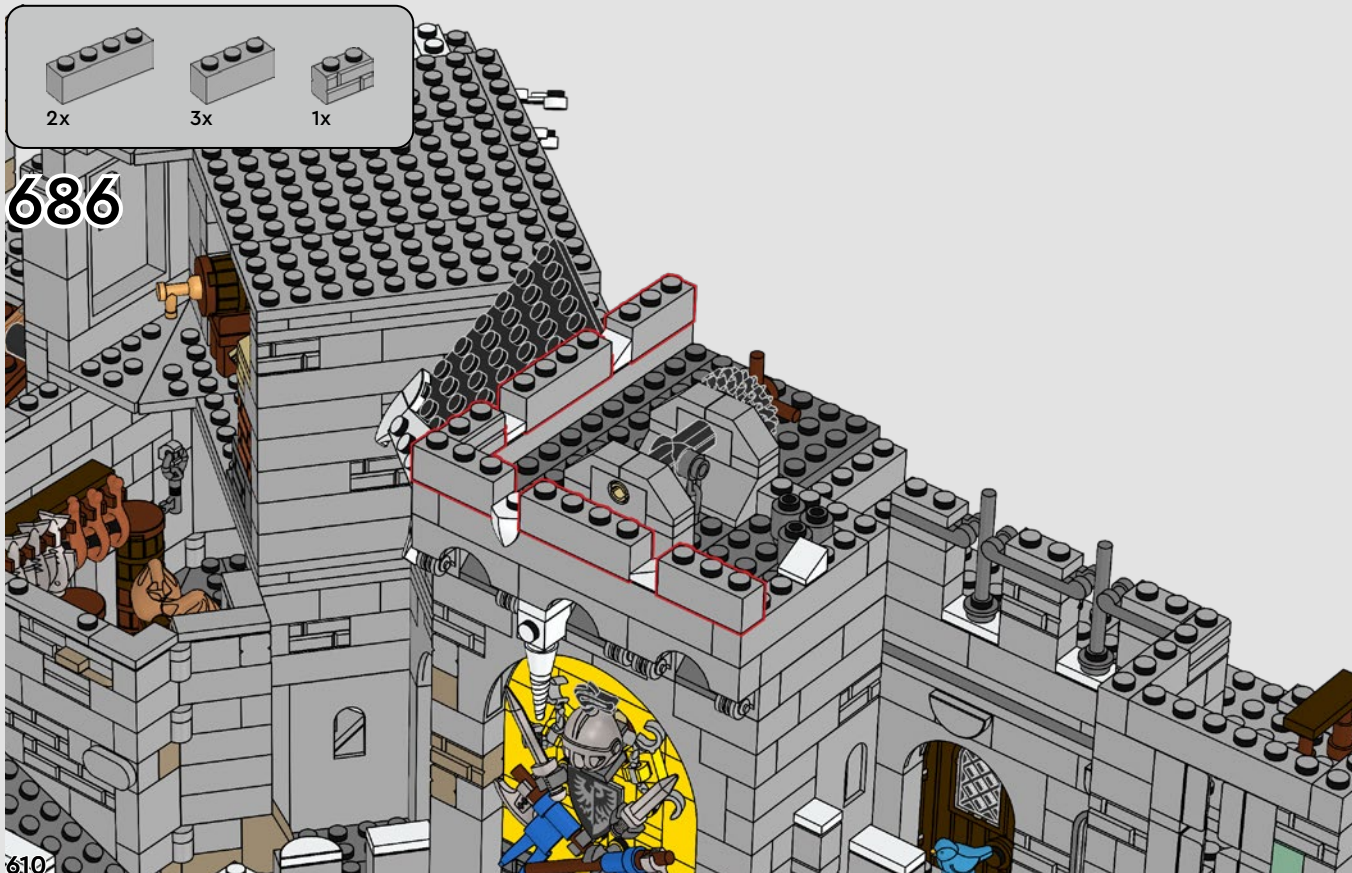



2x



4x



1x



1x



1x



3x

687



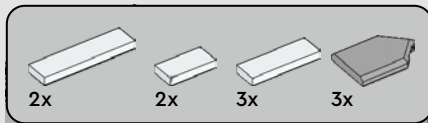

688



689



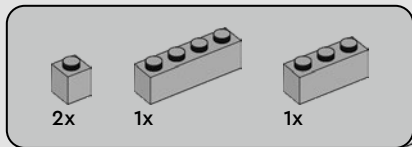

690

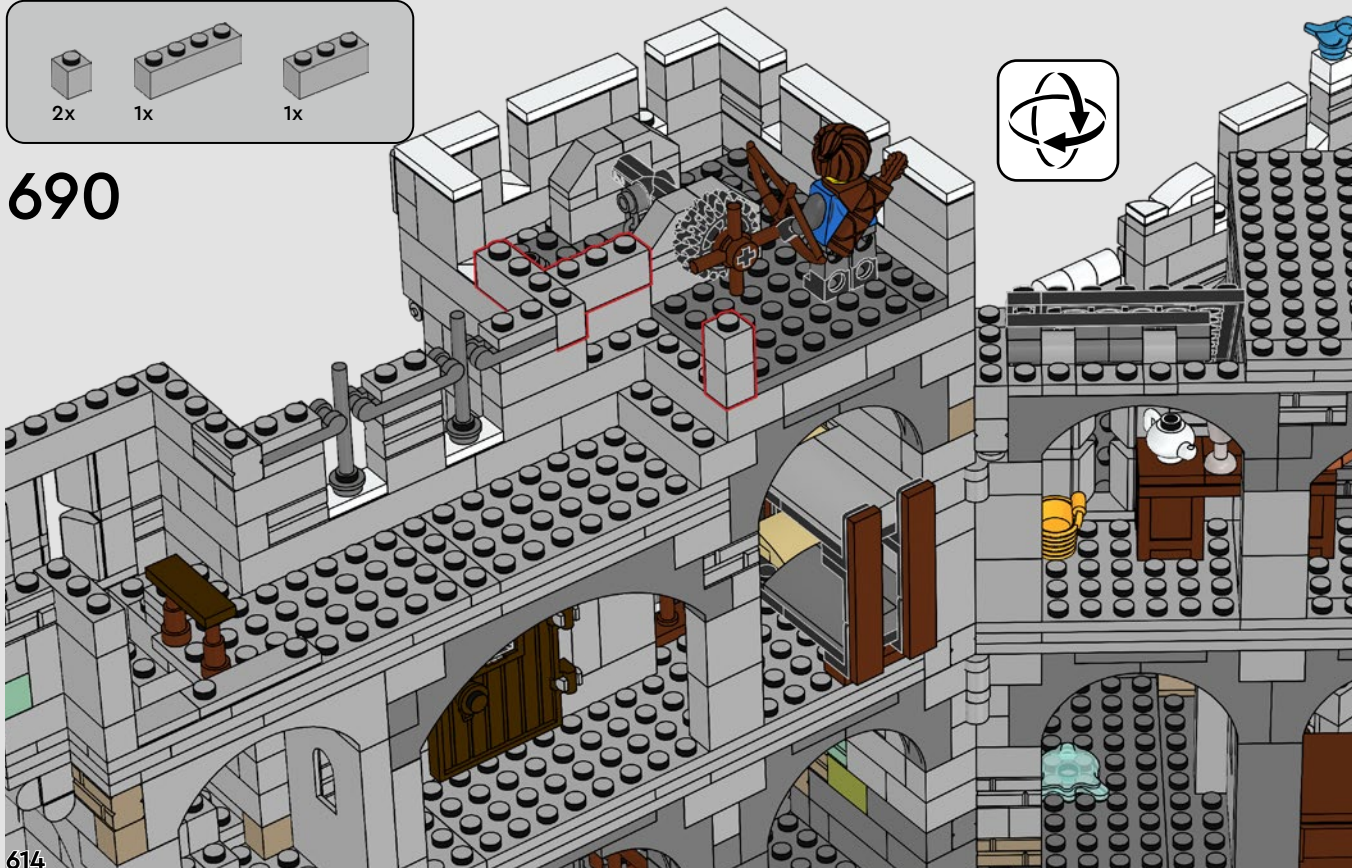
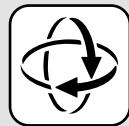



1x



1x

691

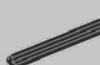
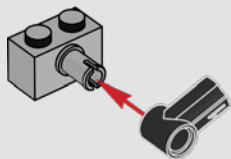

1x



1x

692

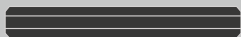
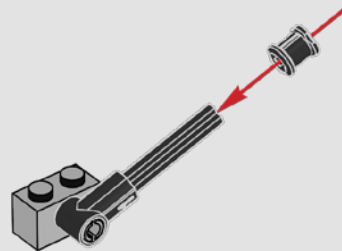

4

1:1

693

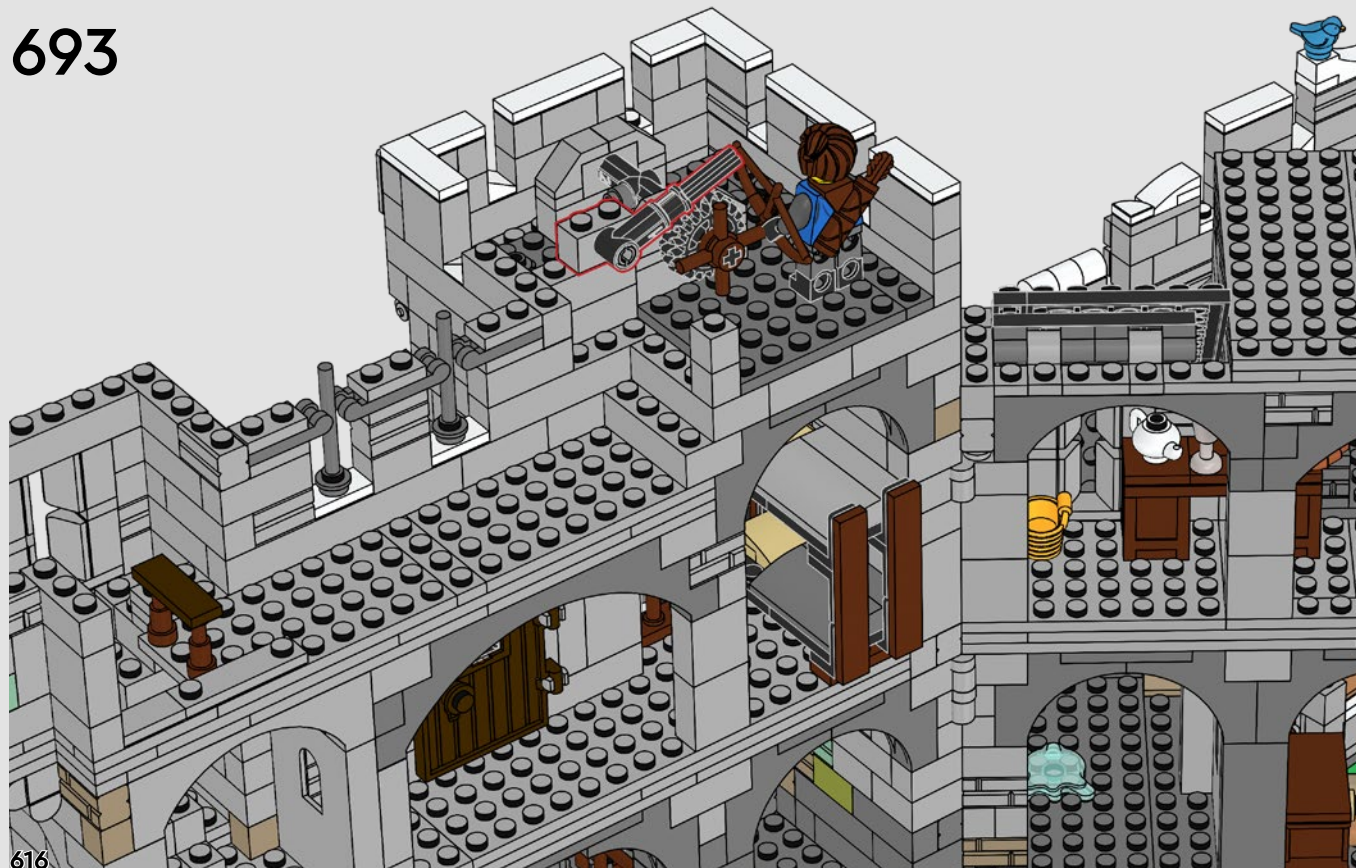

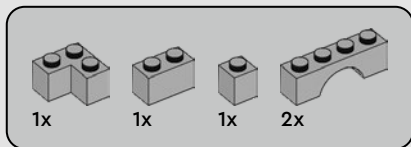

694

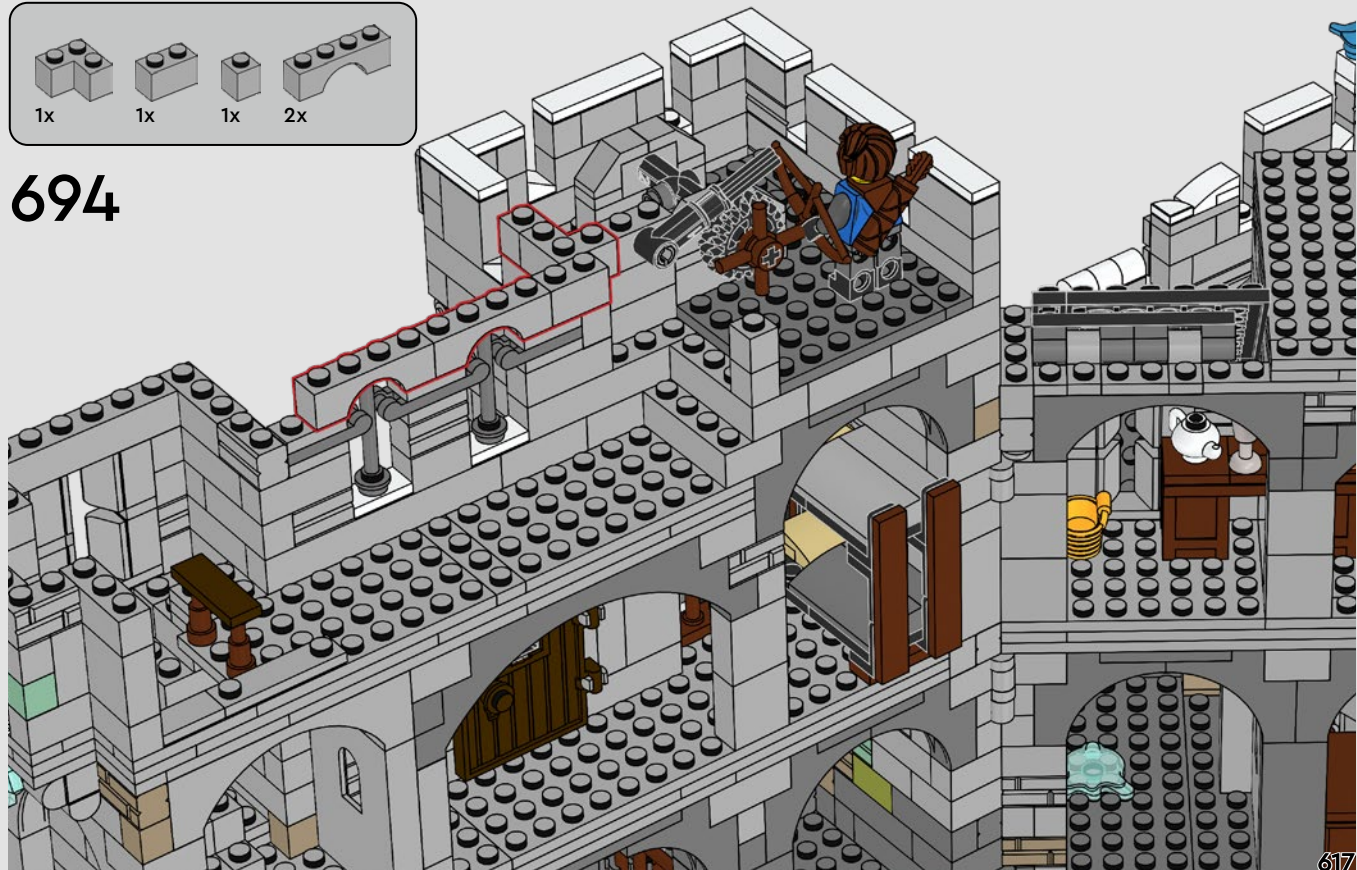

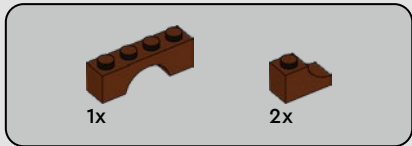
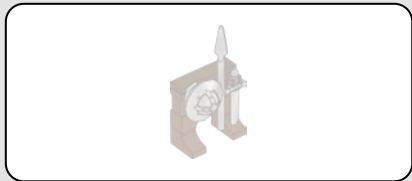

695

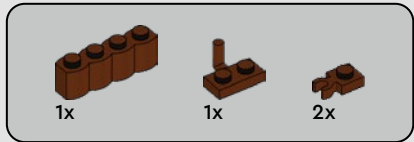
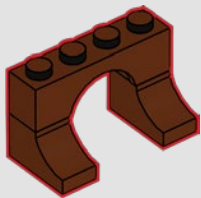

696

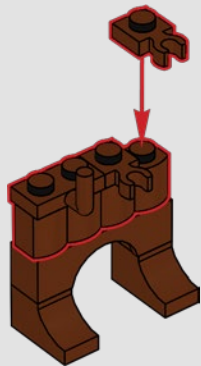

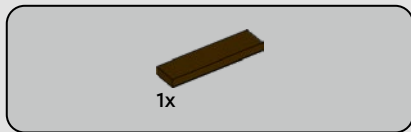

697

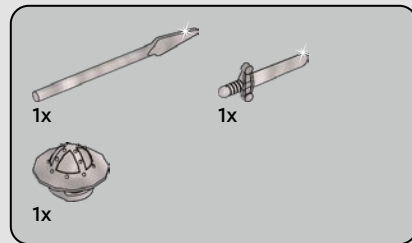
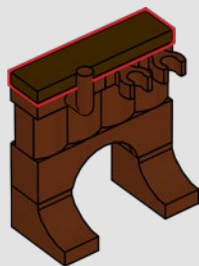

698

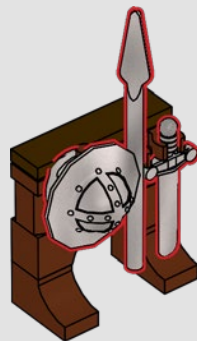

699





1x



1x

700

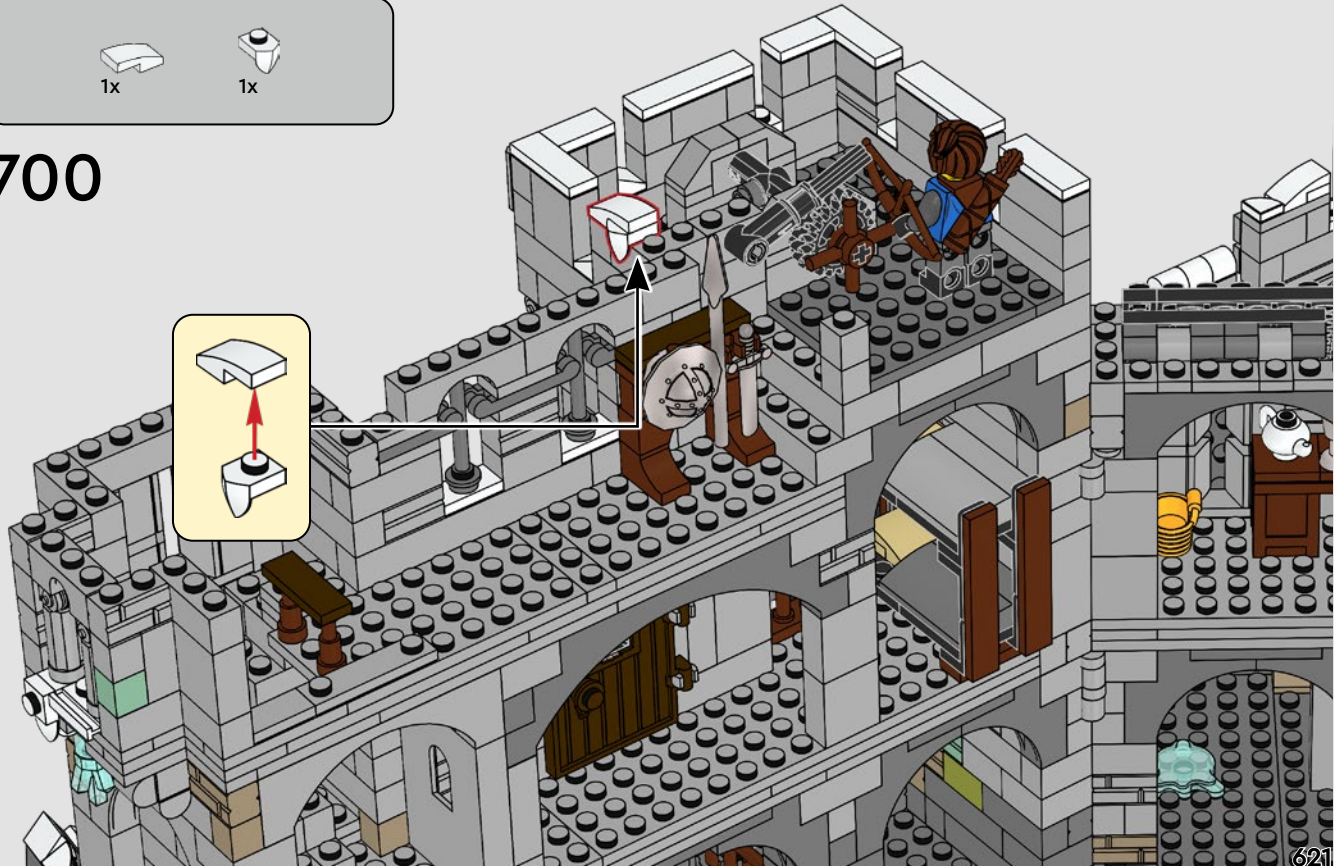
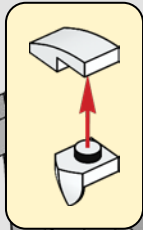

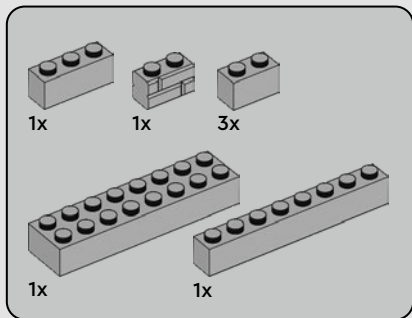

701

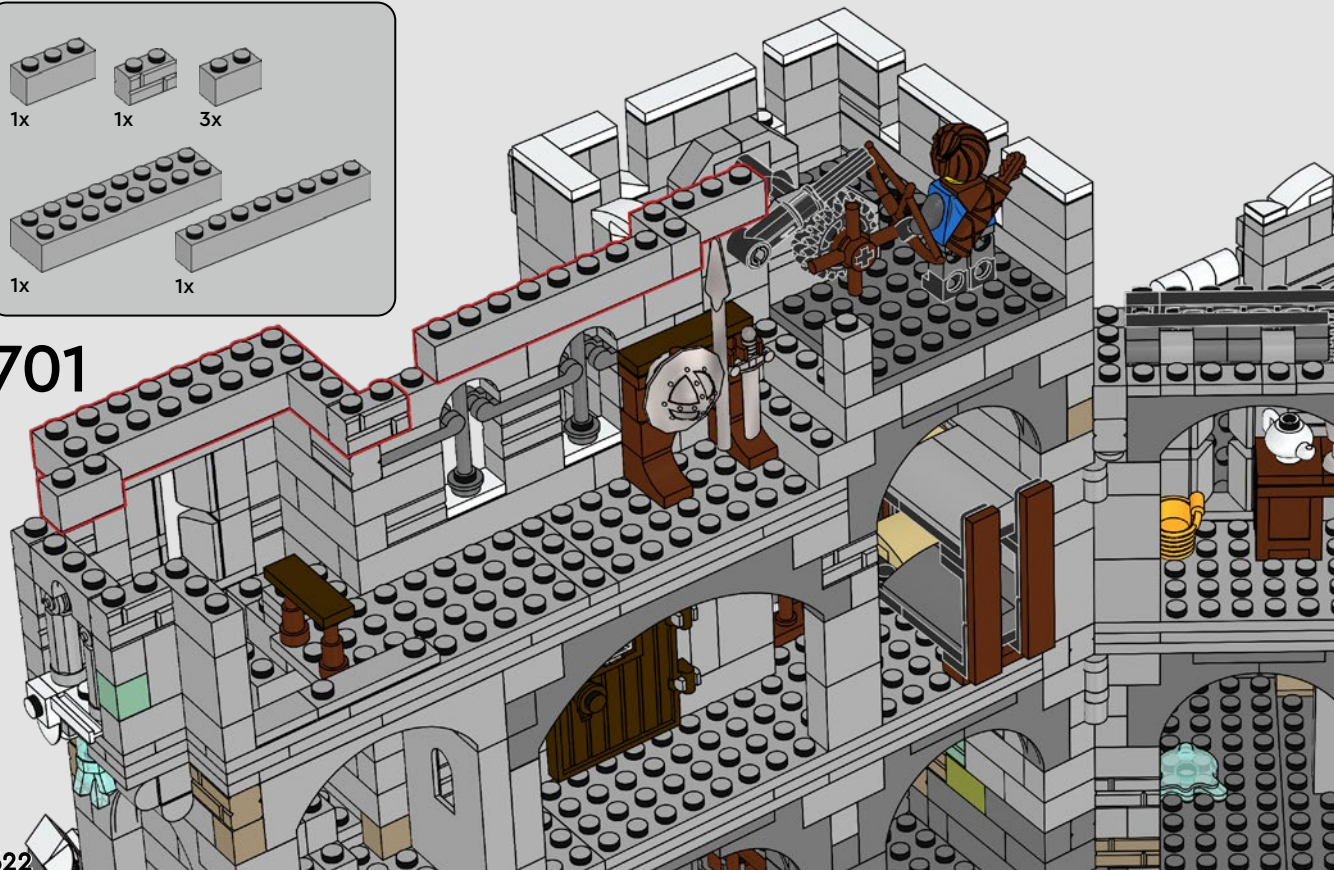

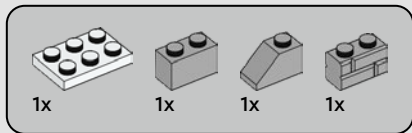

703

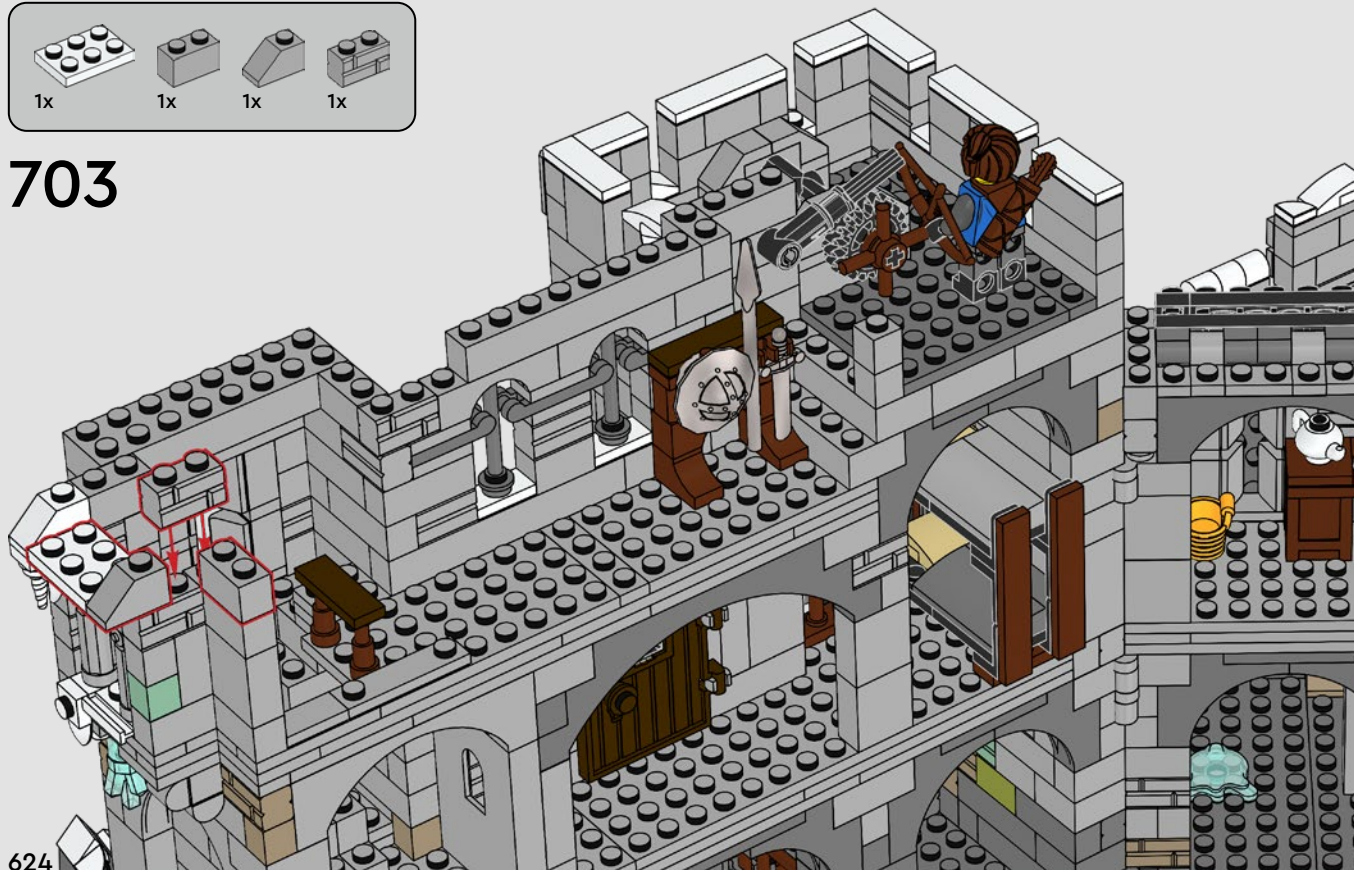

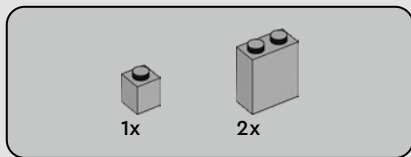

704

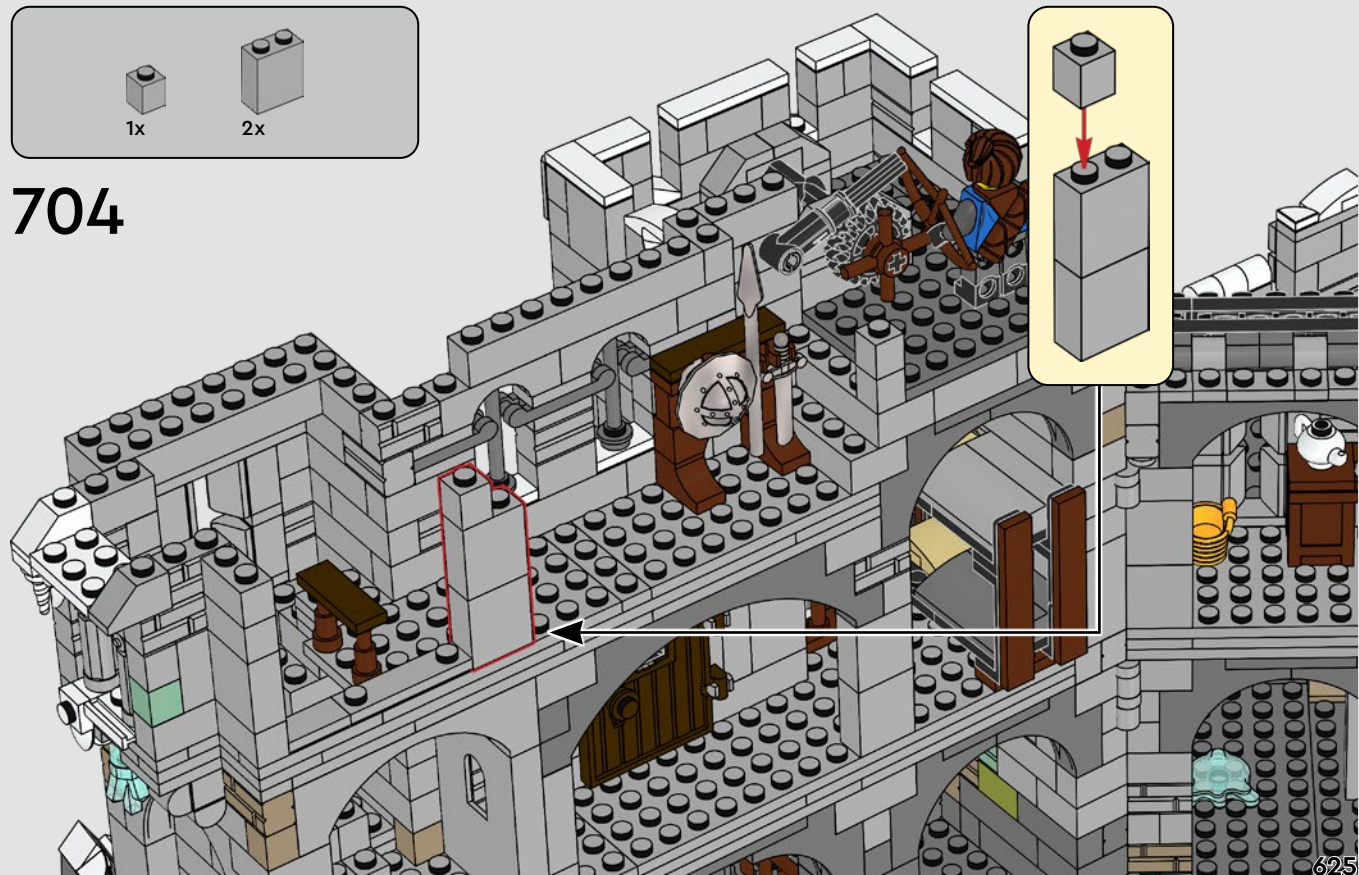



1x



2x

705



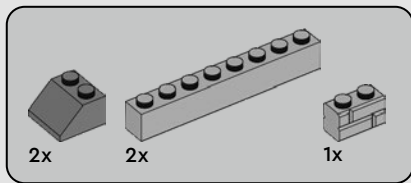

706

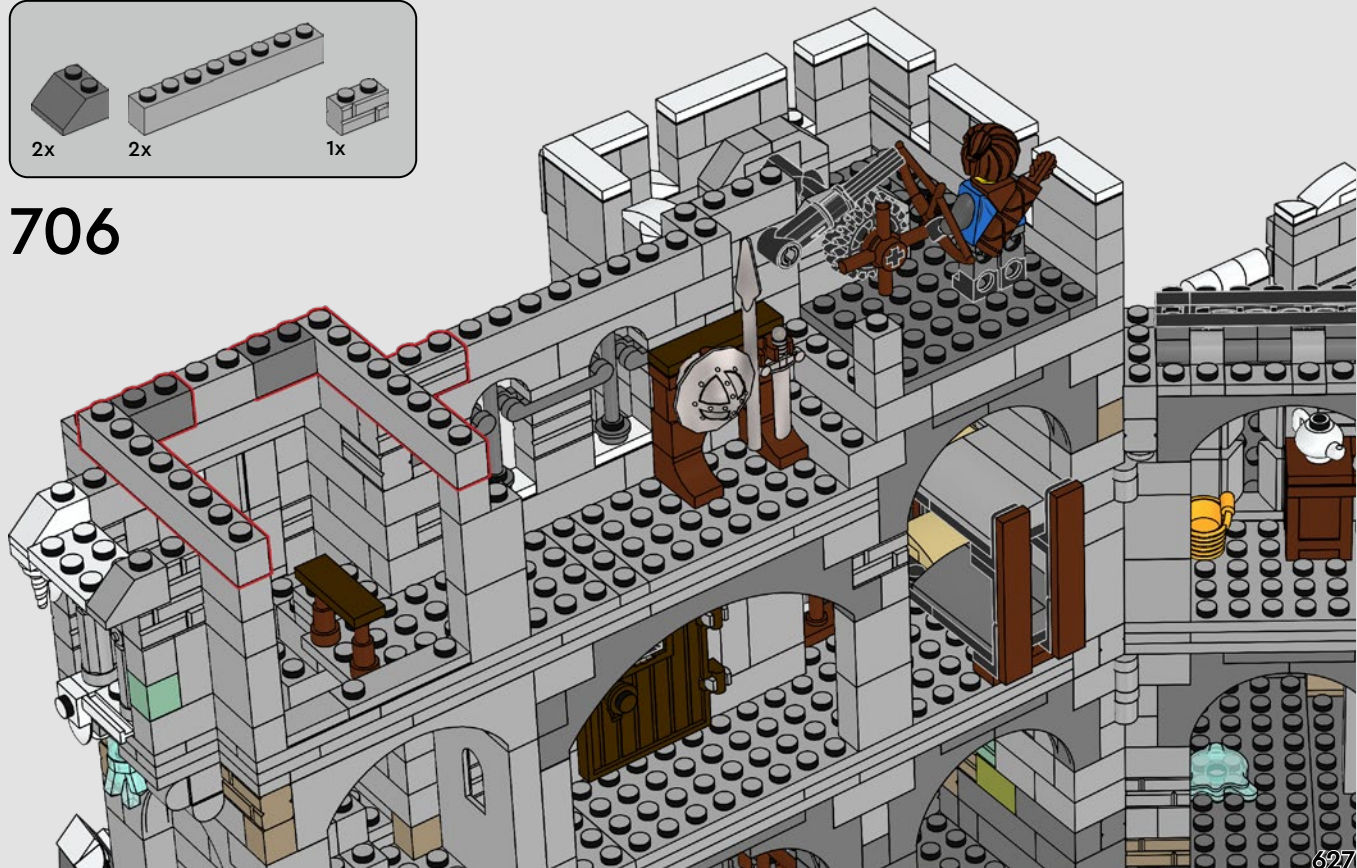



1x



2x

707



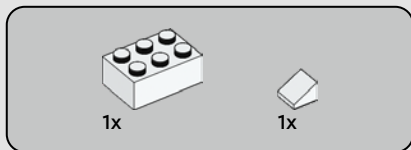

708





1x



1x

709



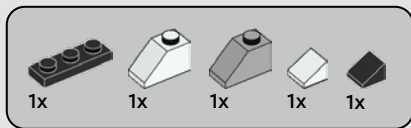

710

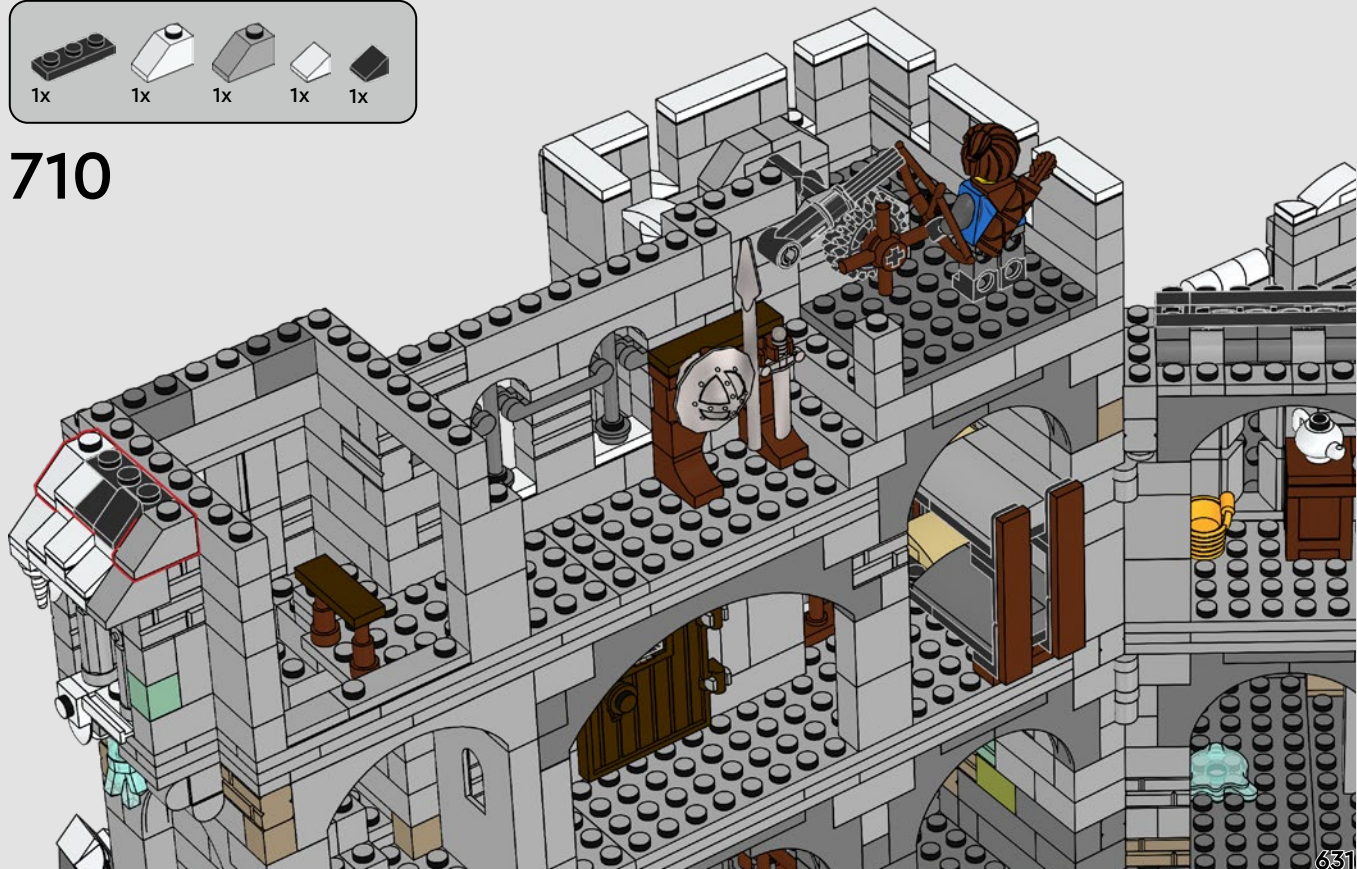



1x



1x



1x

711





2x

712

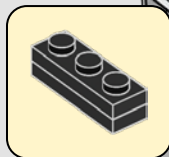

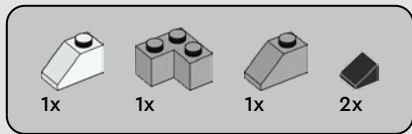

713



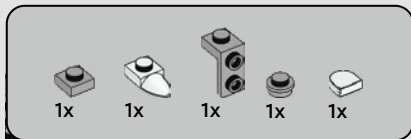

714

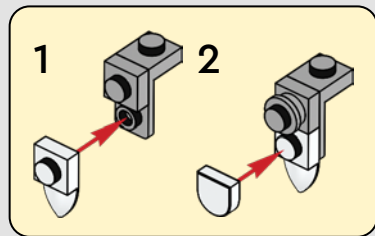
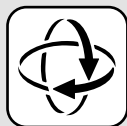

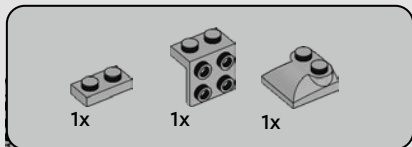

715

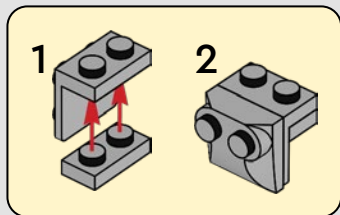

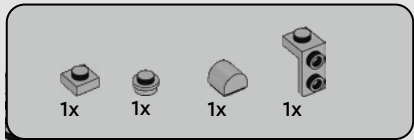

716

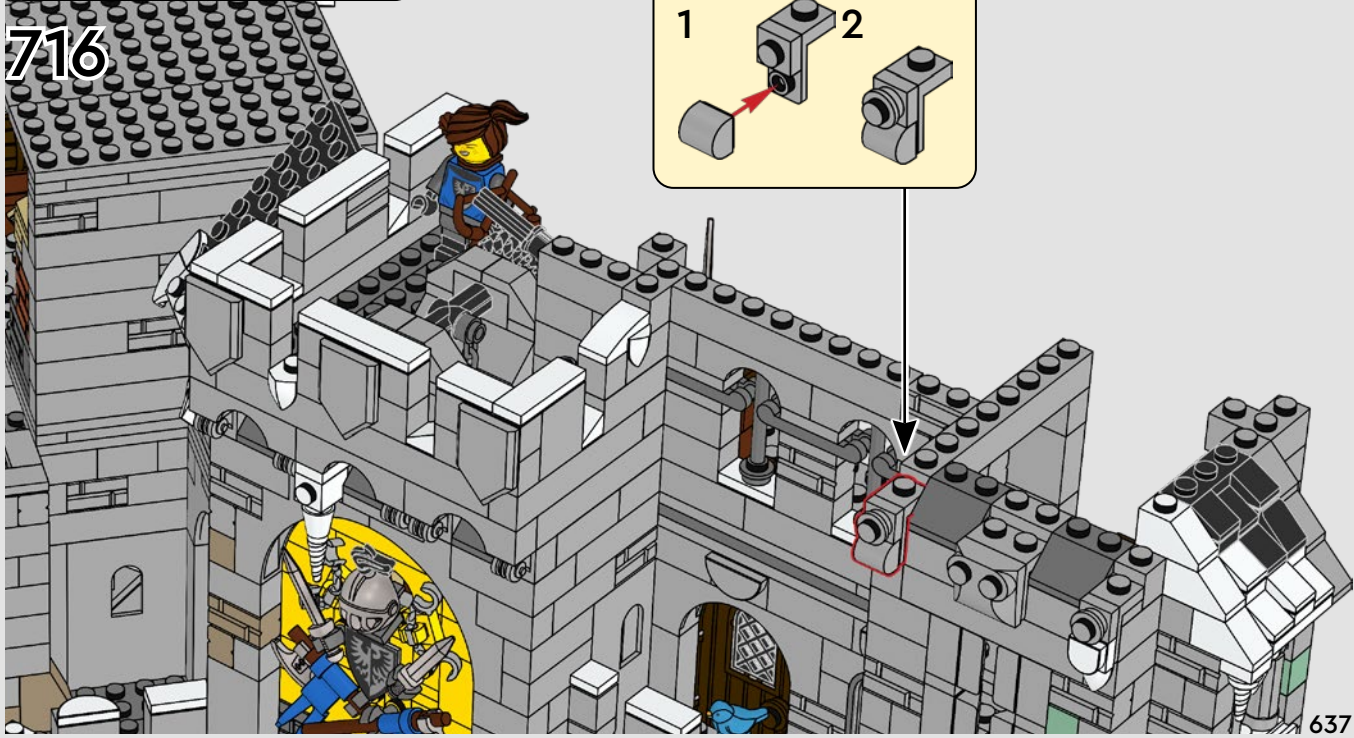
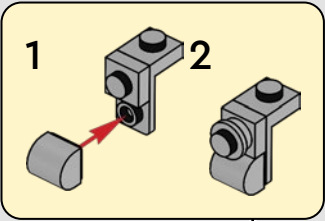



1x



2x

717





2x



2x



1x

718



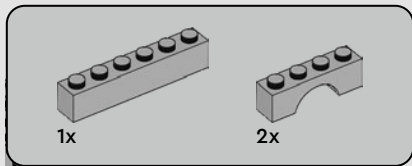

719



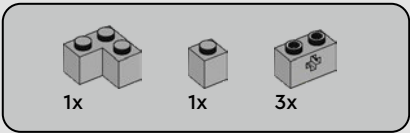

720

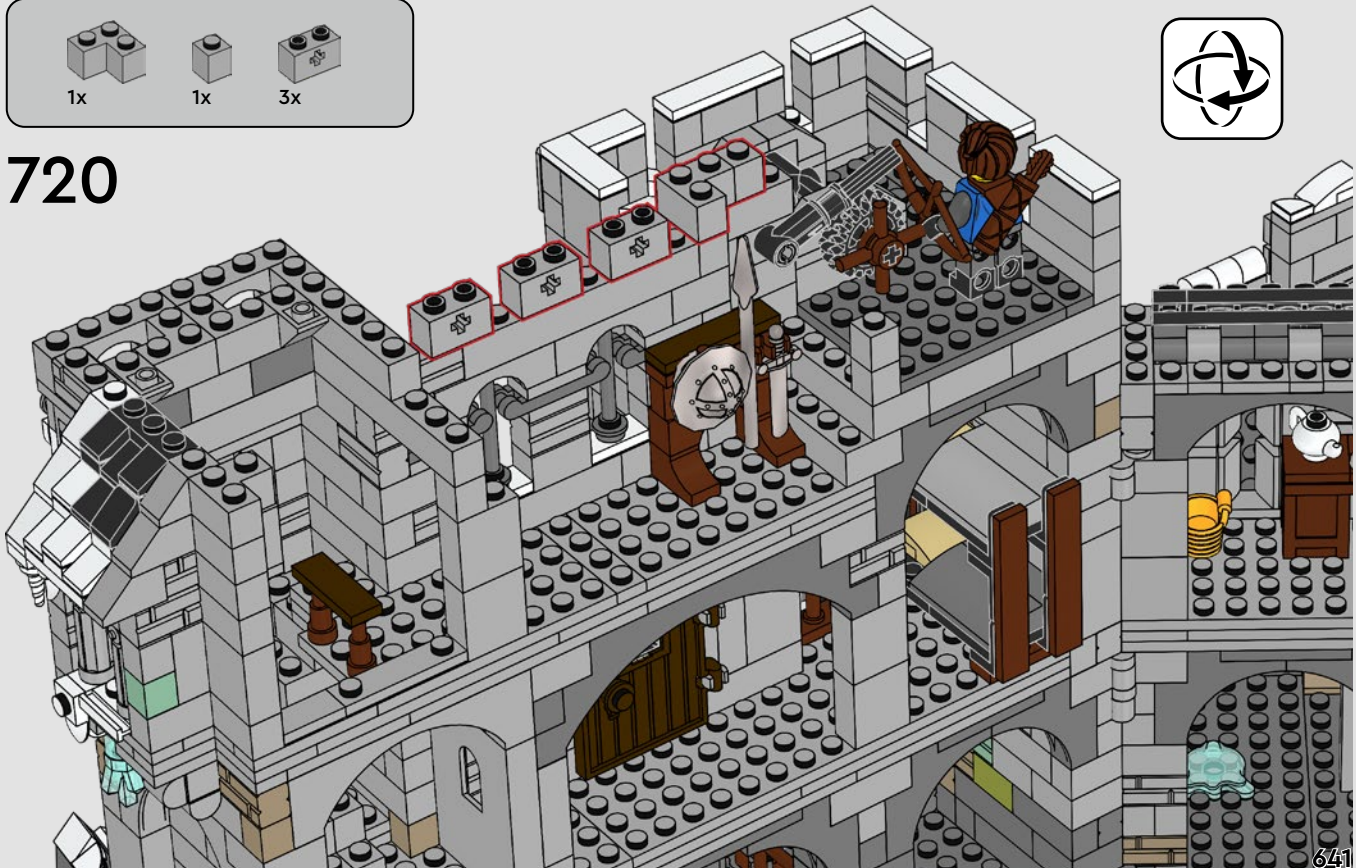



3x

721





1x



1x

722

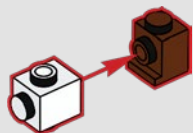

1x

723



1x



1x

724



725

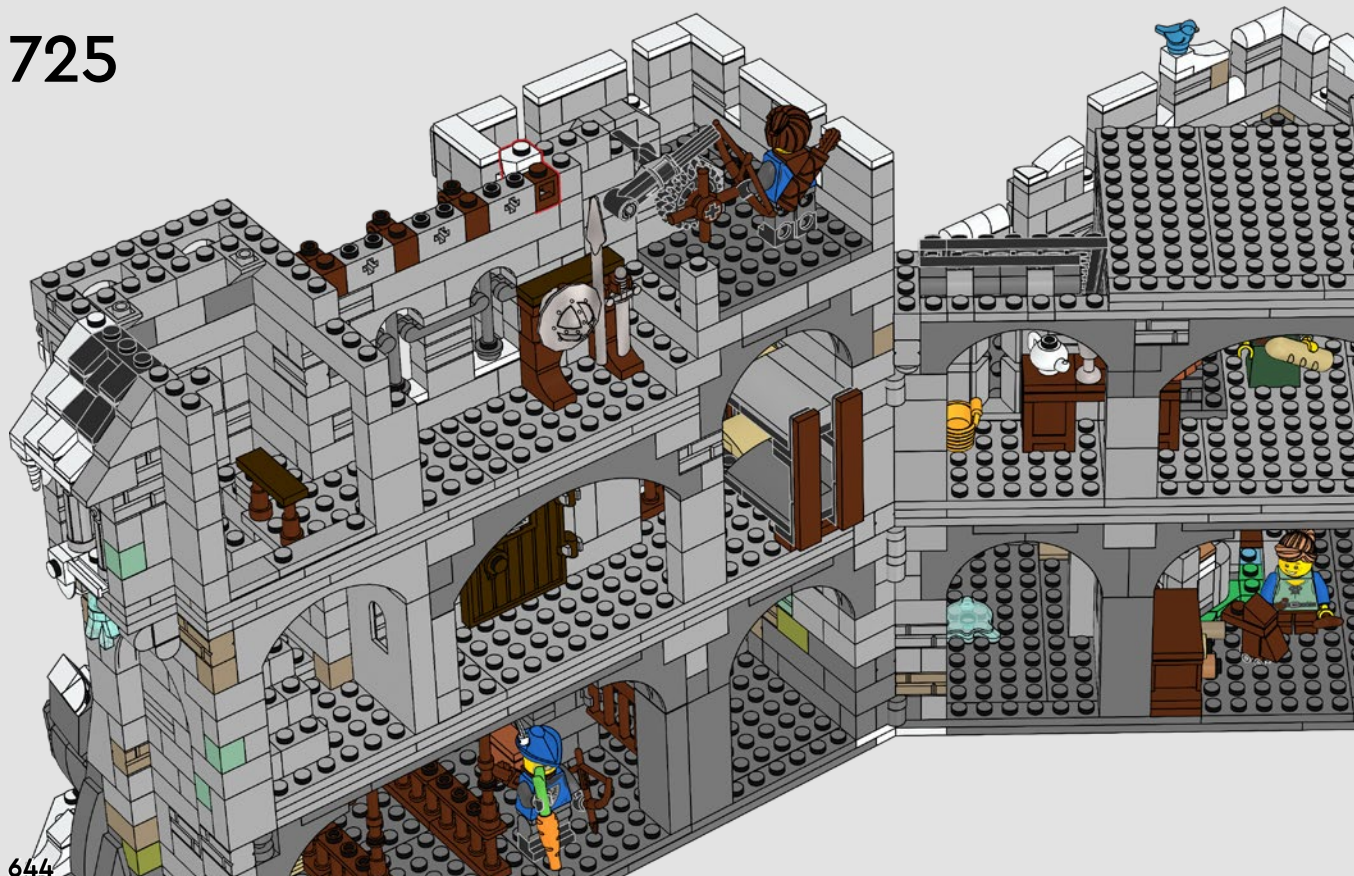

644

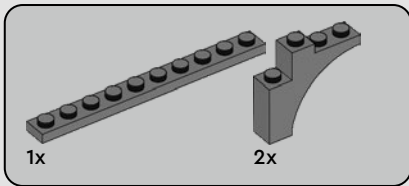

726

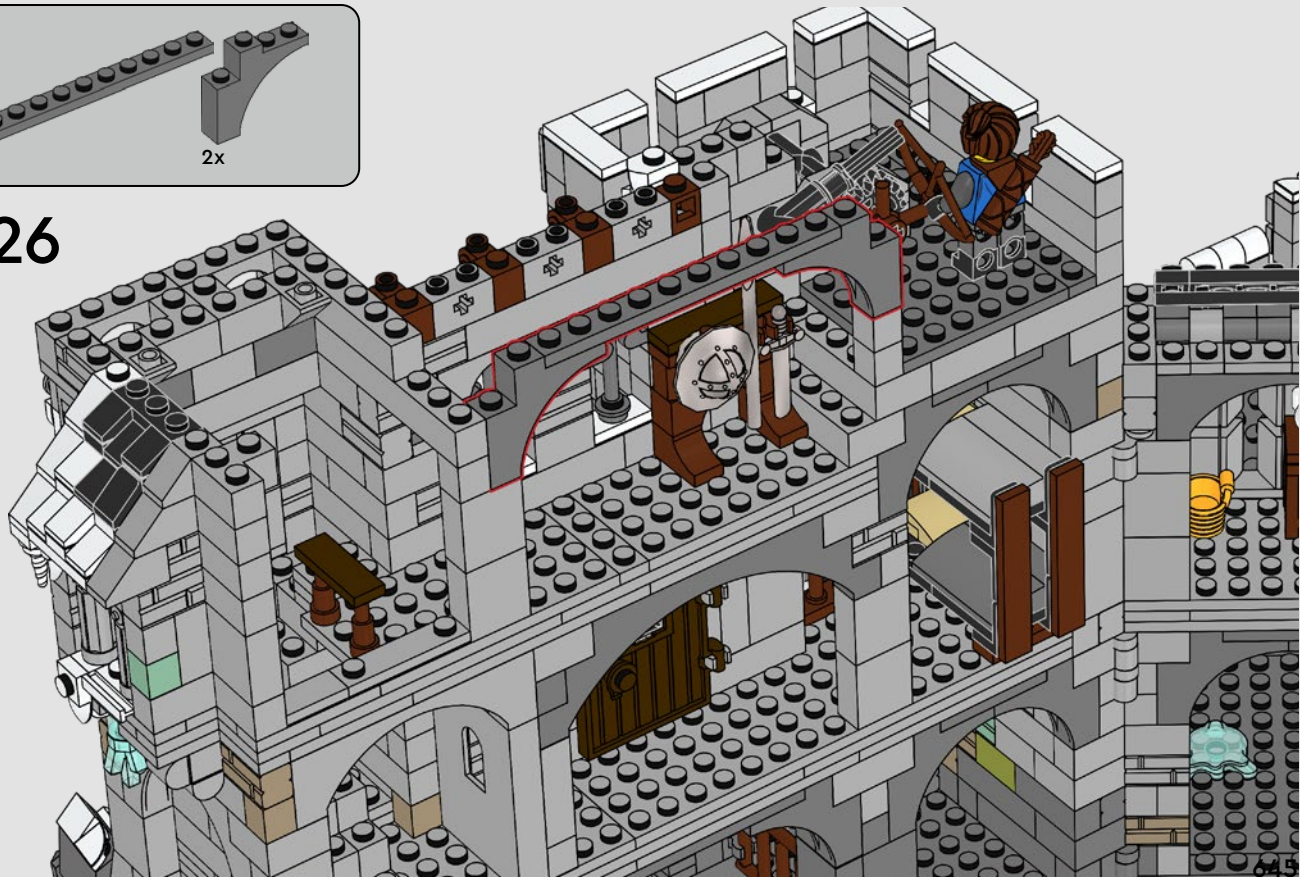

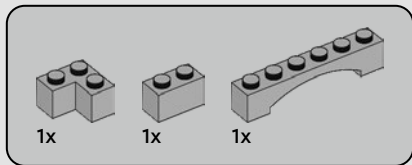

727

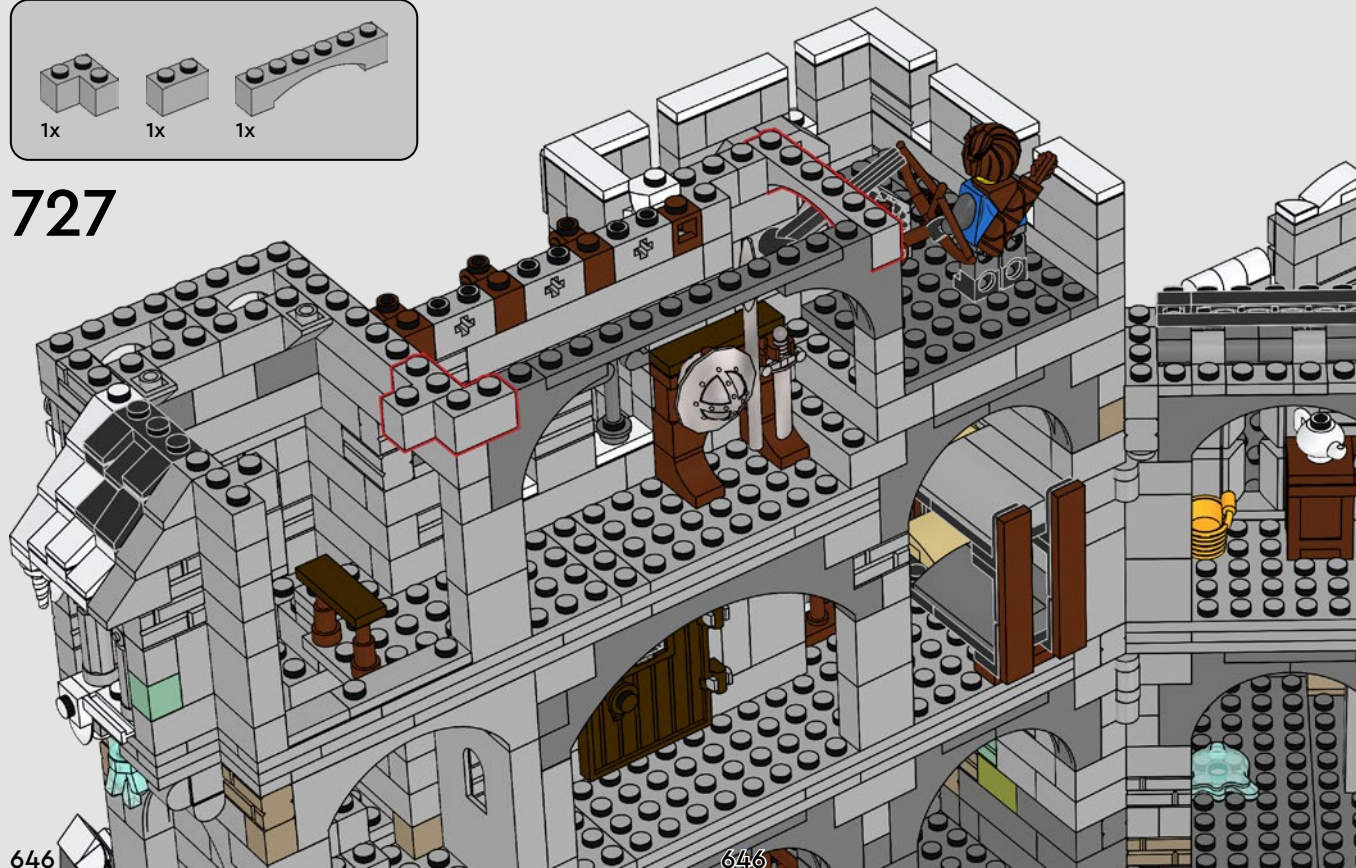

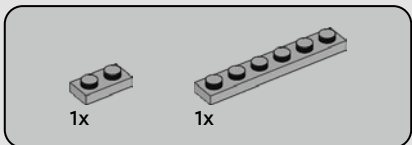
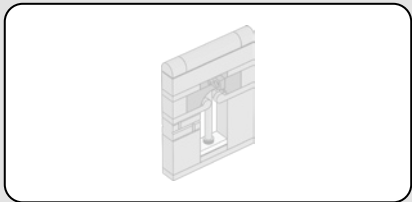

728

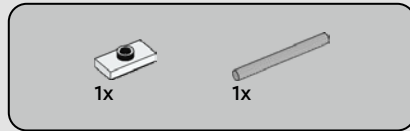
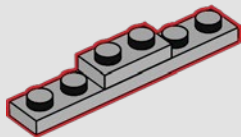

729

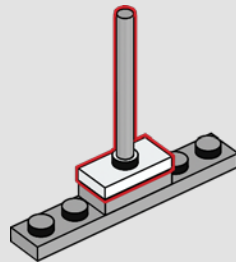

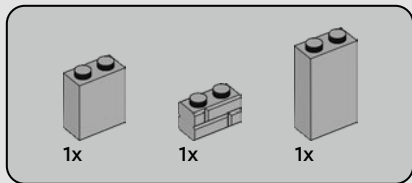

730

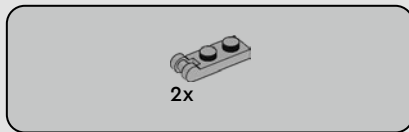
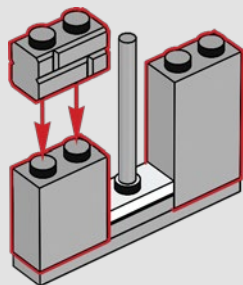

731

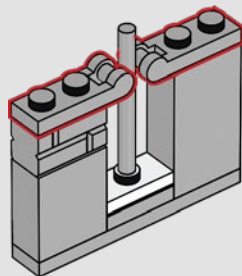

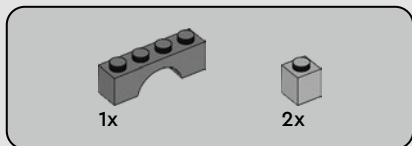

732

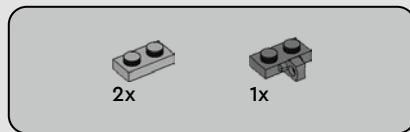
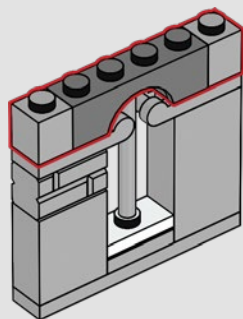

733

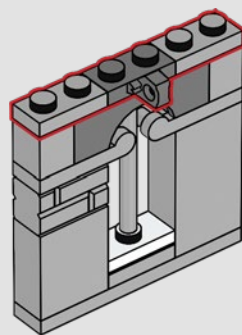

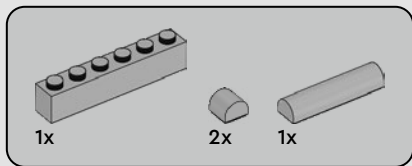

734

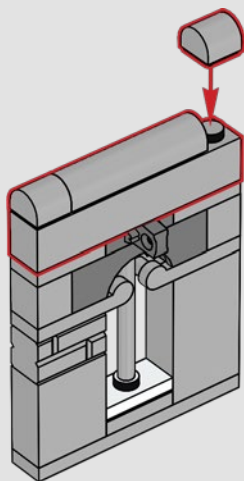

735

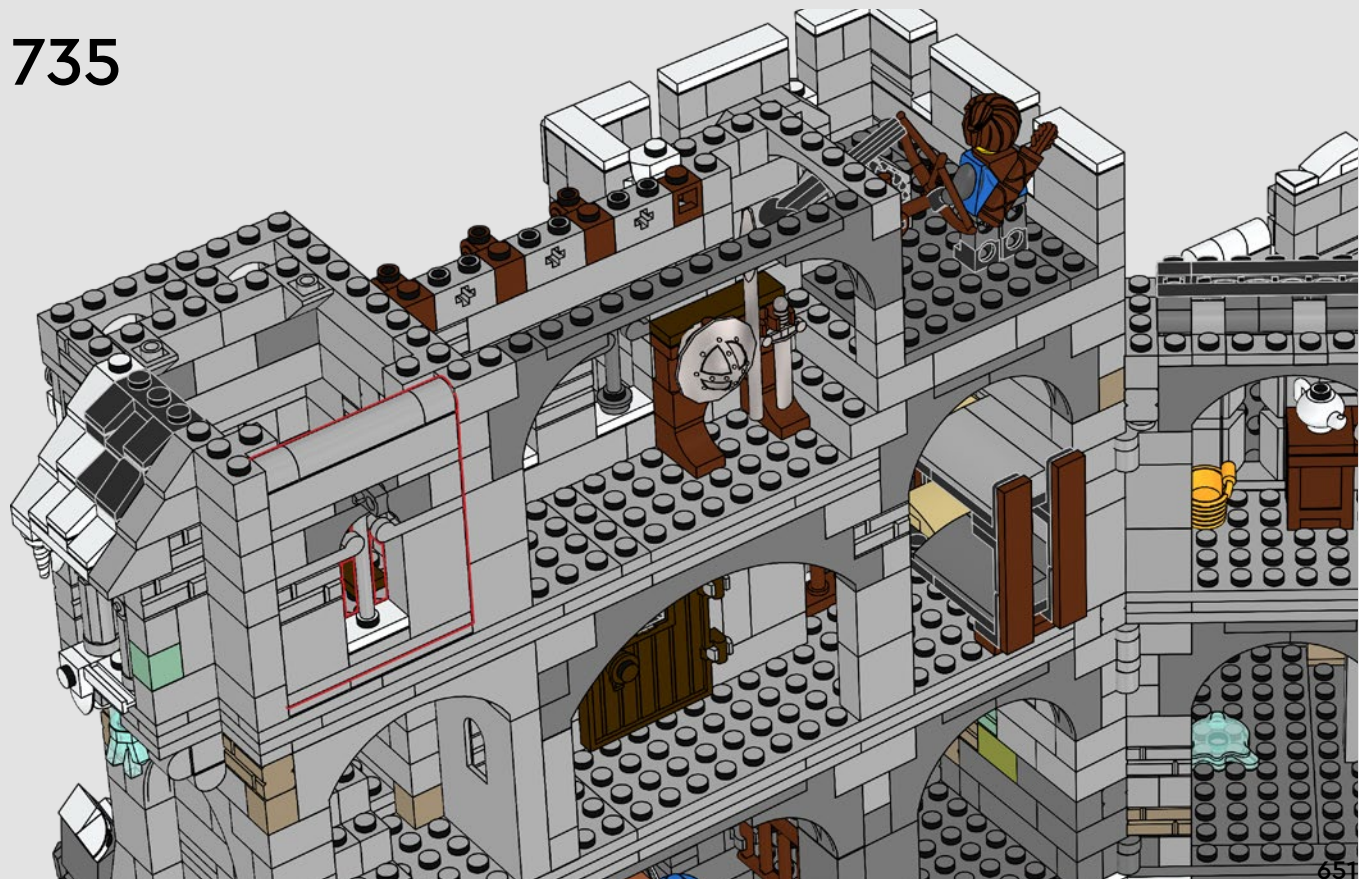

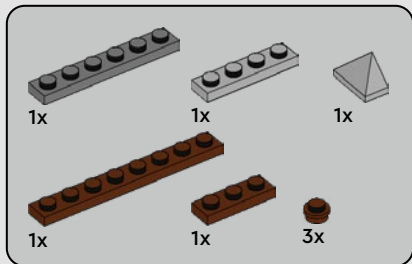

736

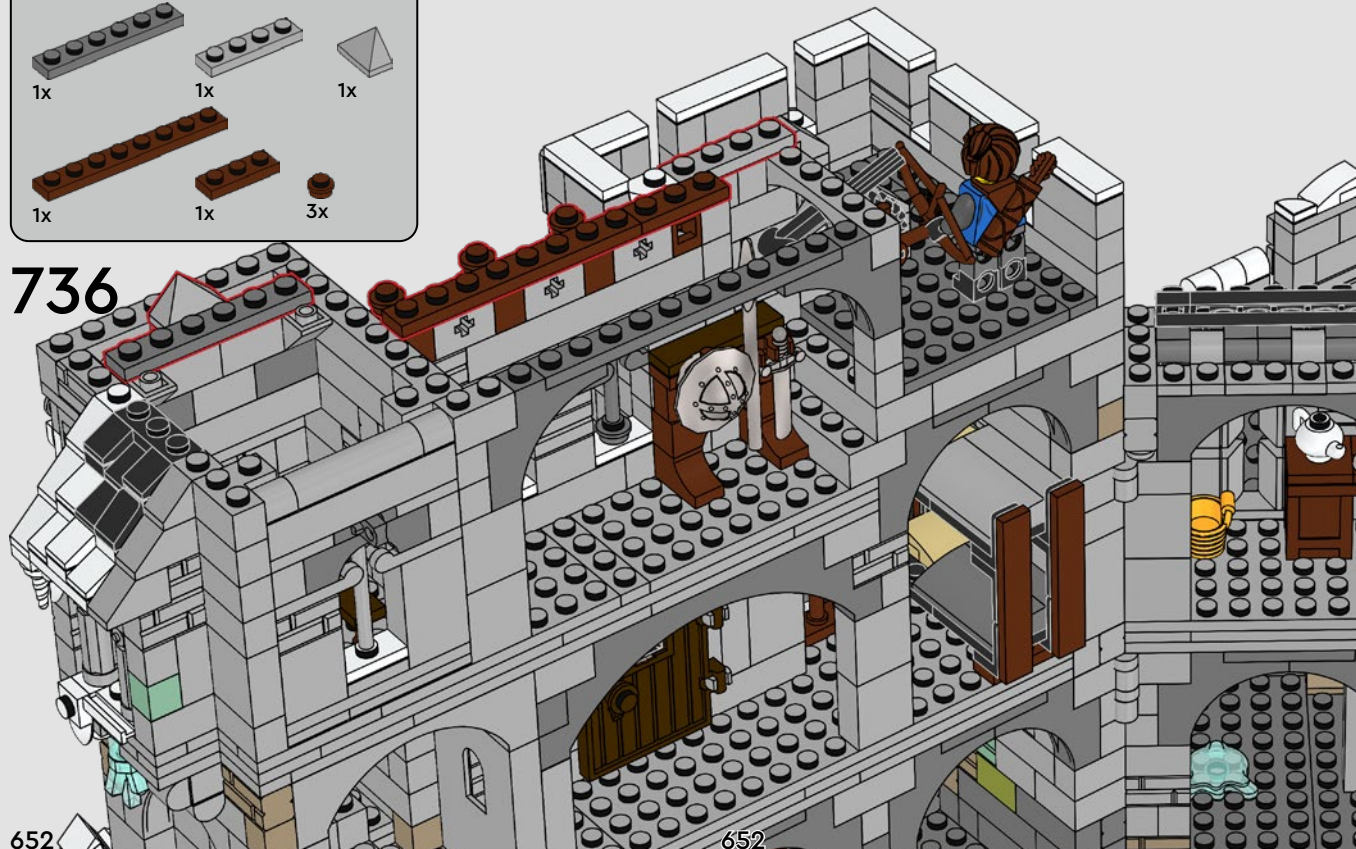

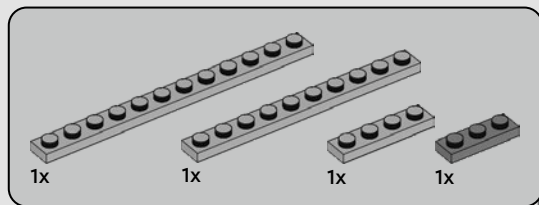

737

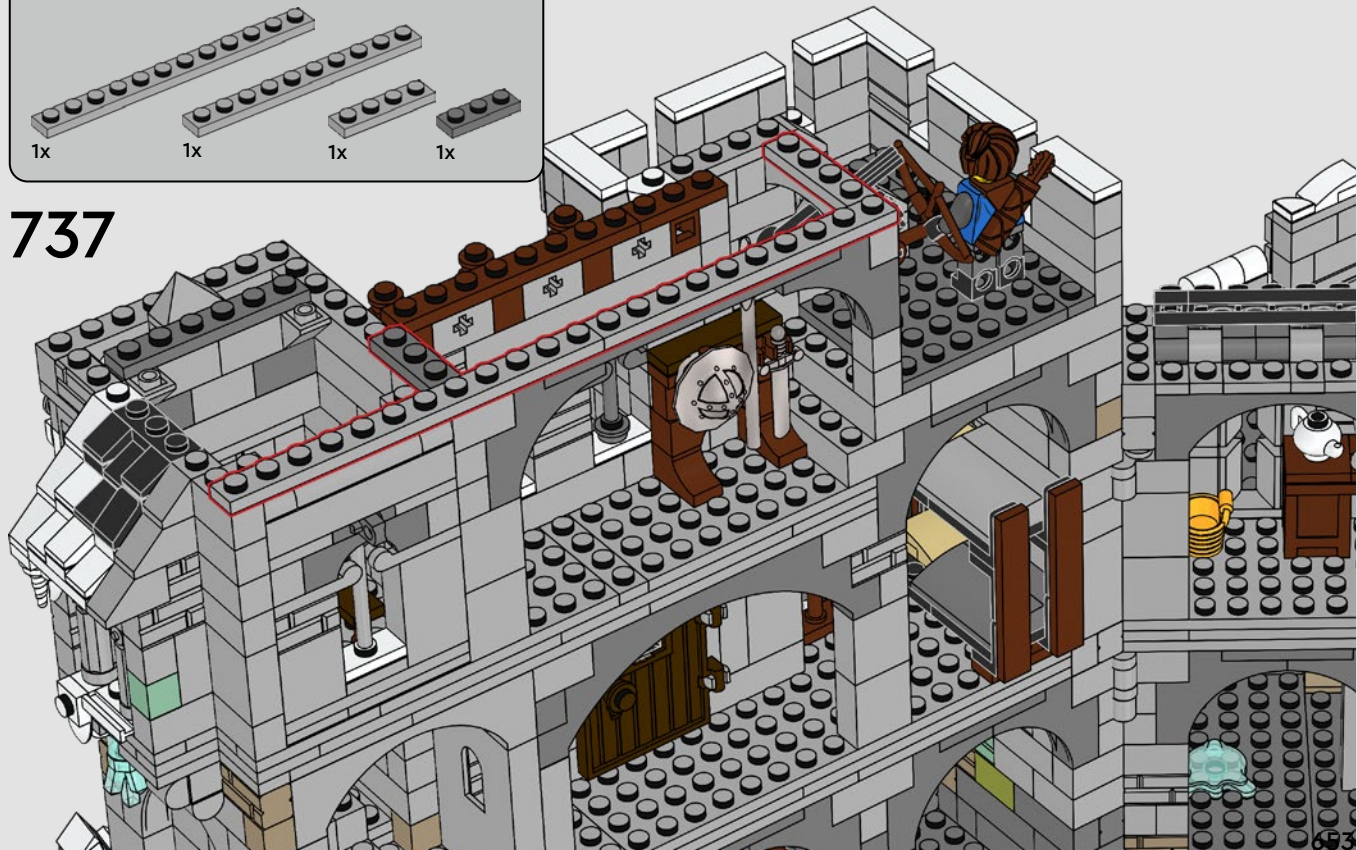

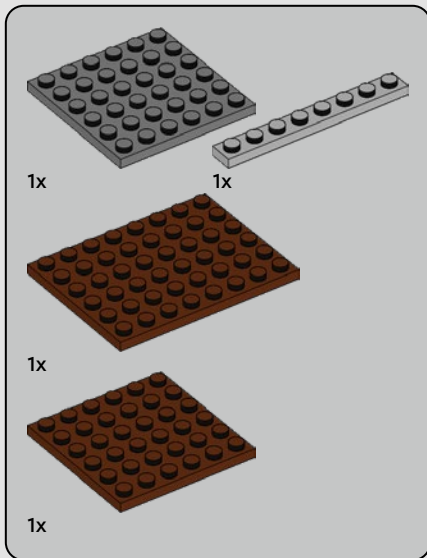

738

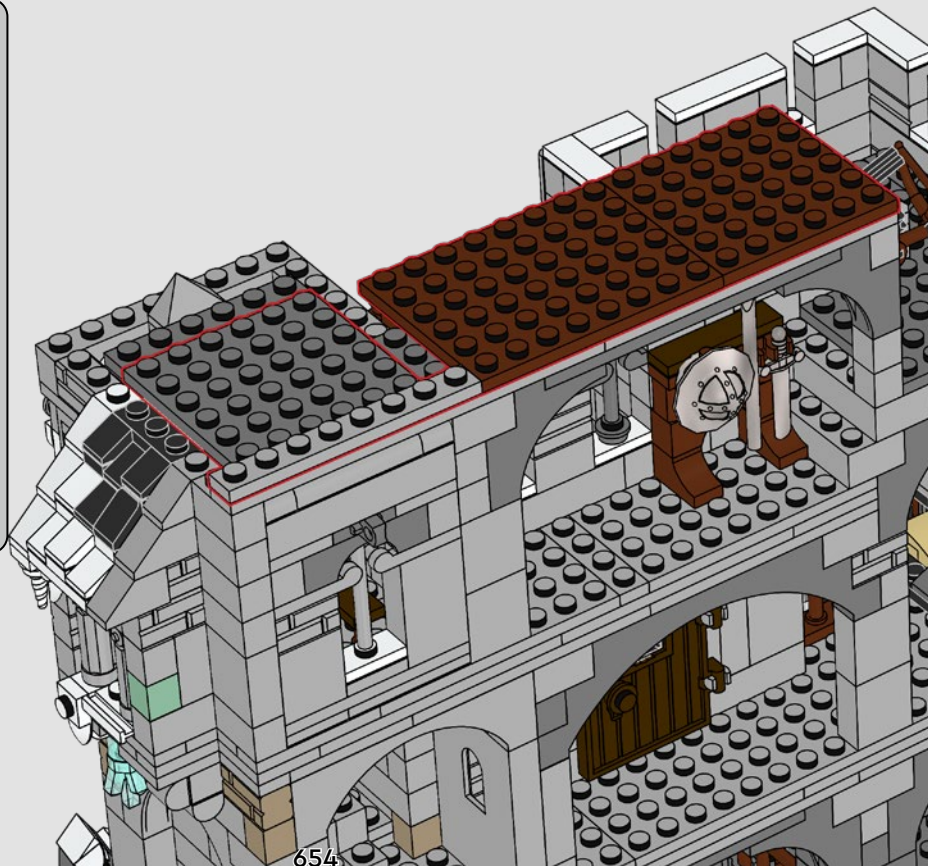

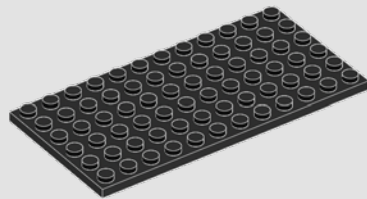
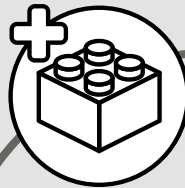
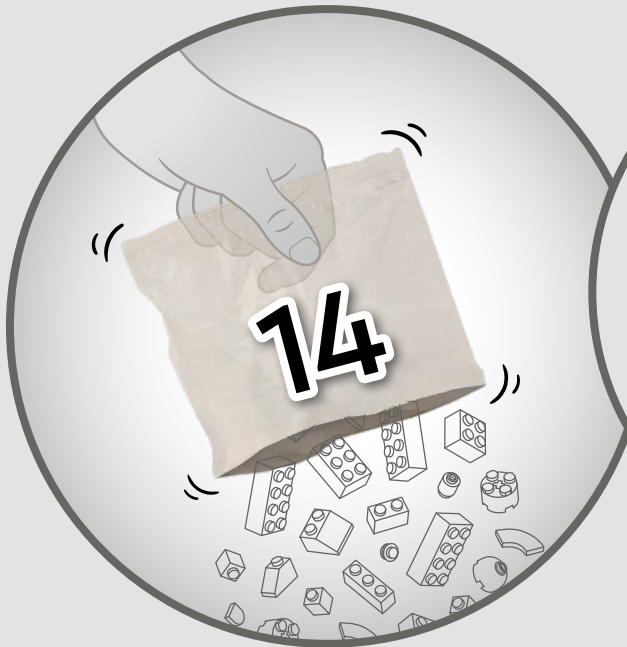

1x

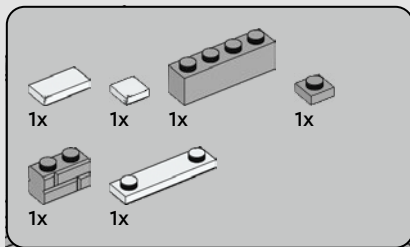

735

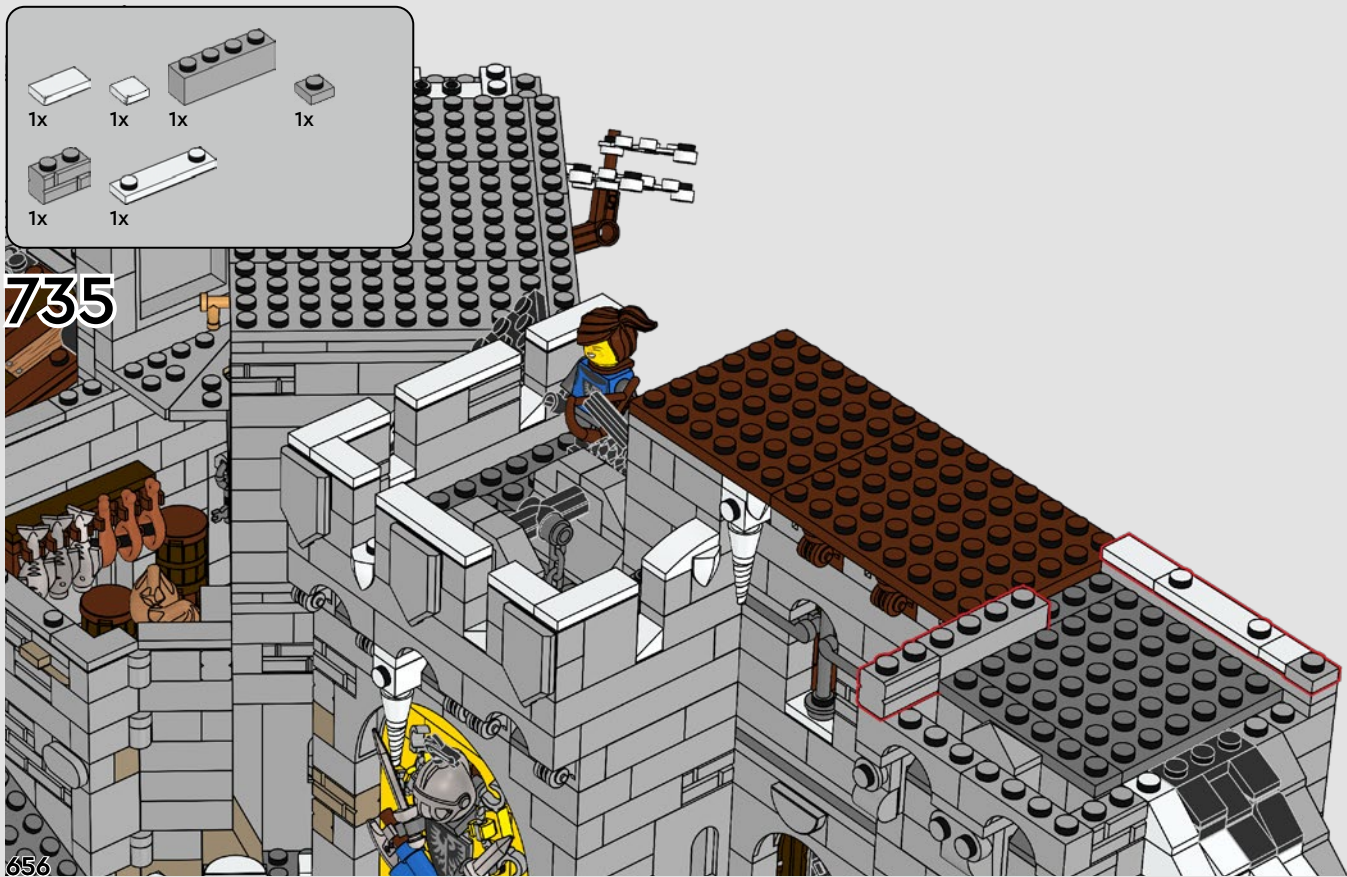

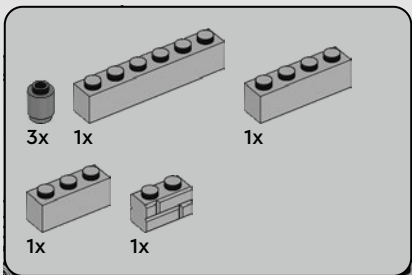

736

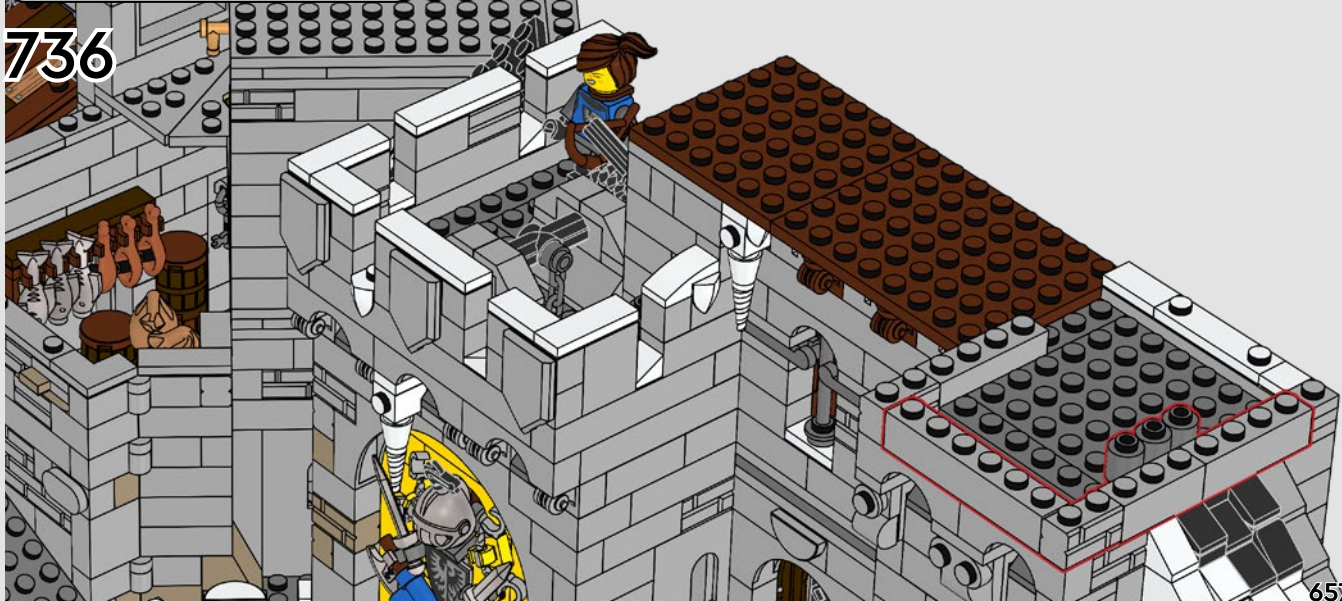



737

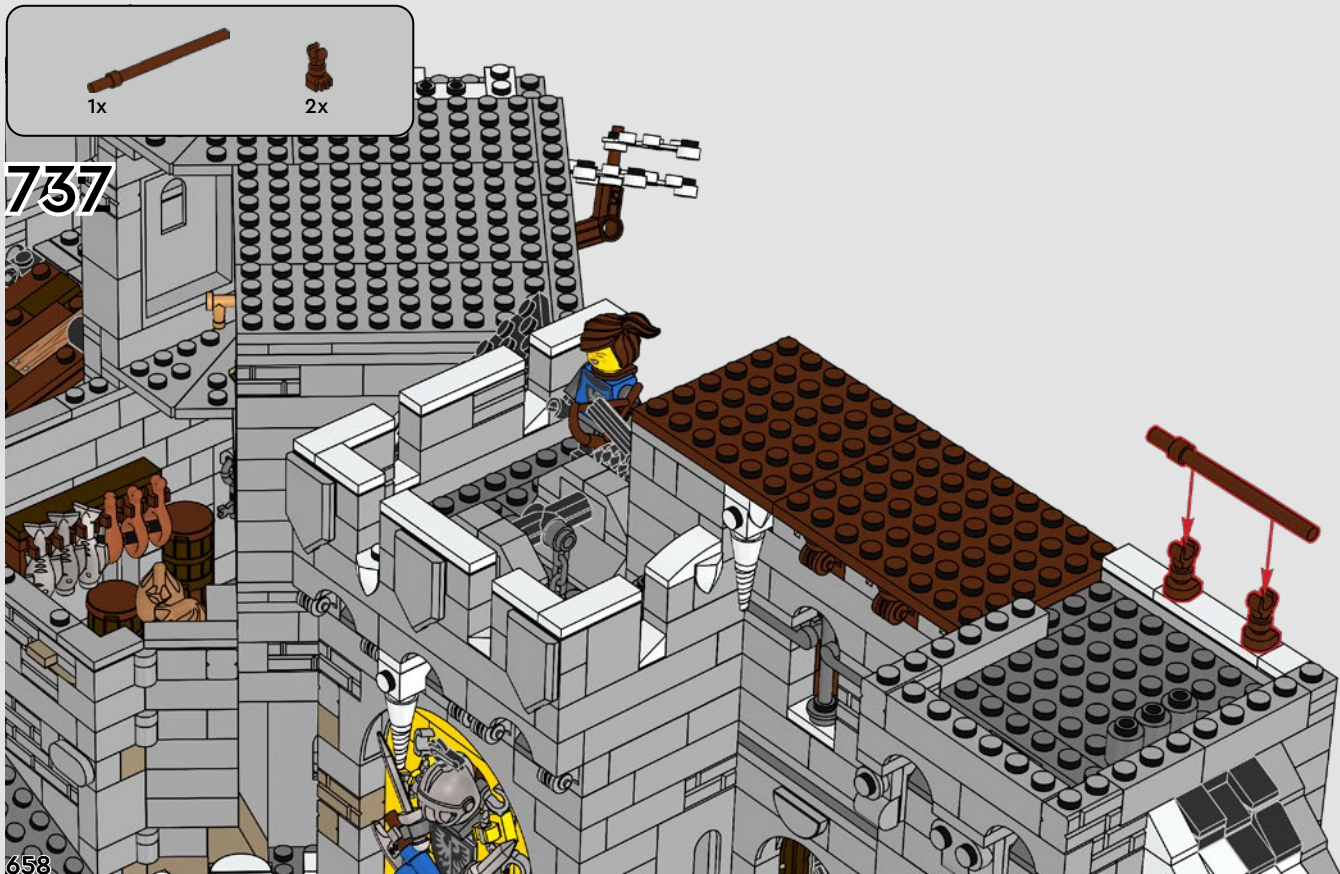



3x



2x

738

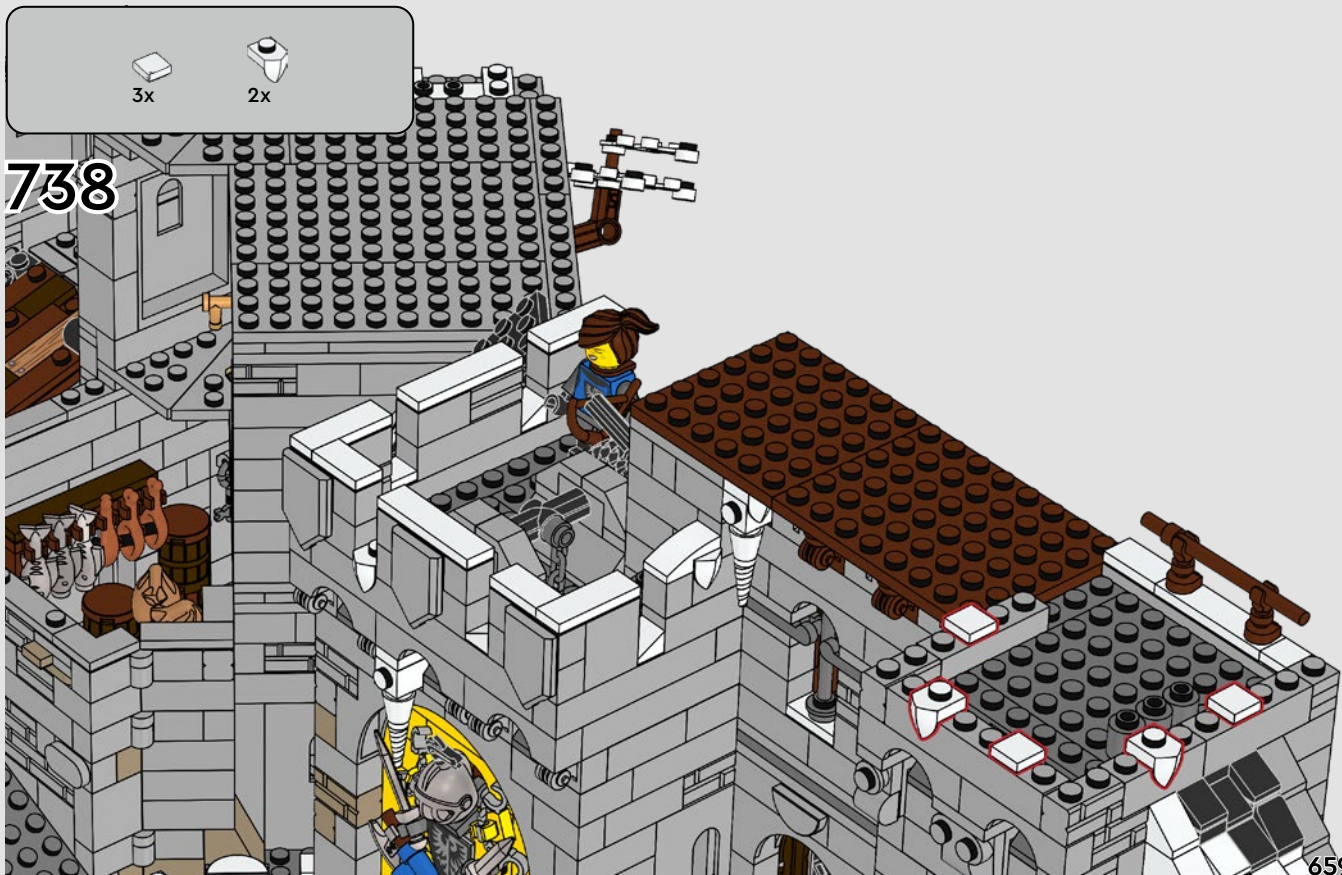

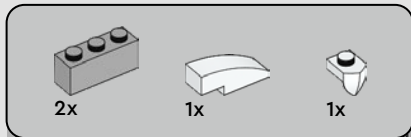

739

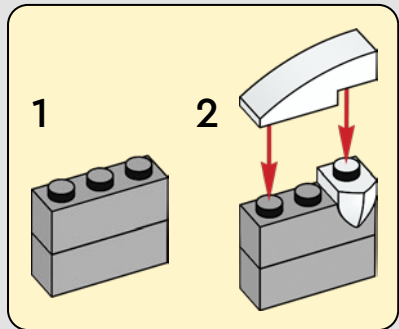
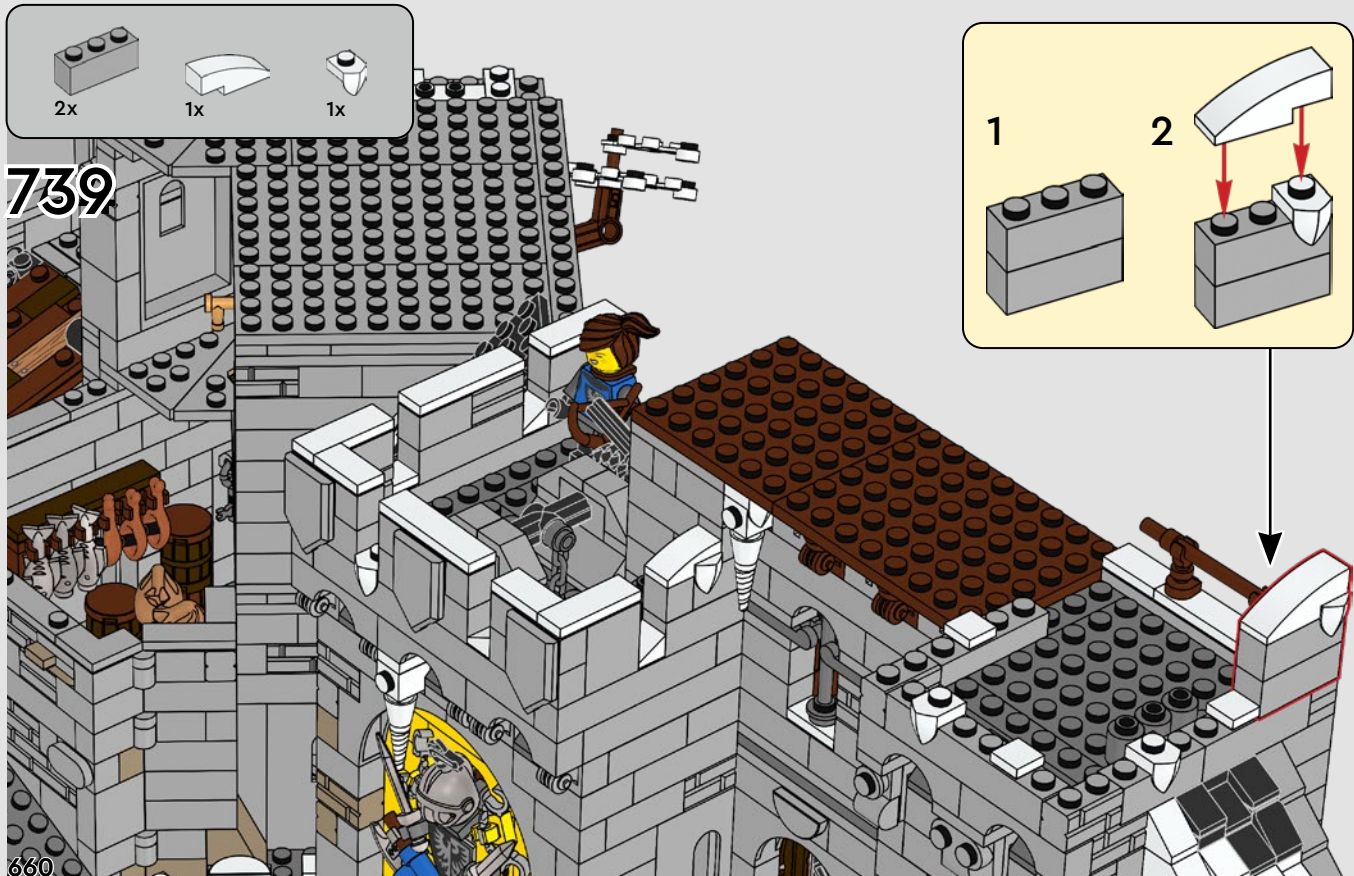

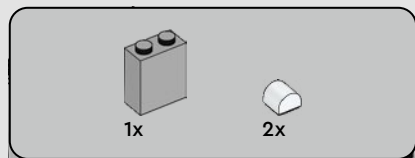

740

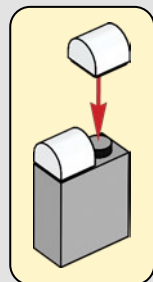



1x



1x

746

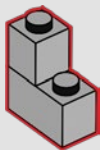

1x



1x

747

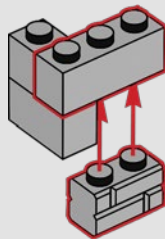

1x



1x

748

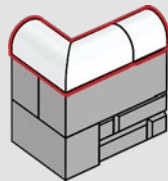

7/44



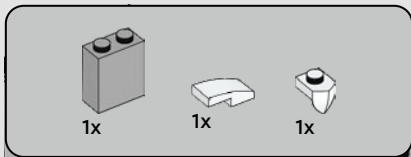

745

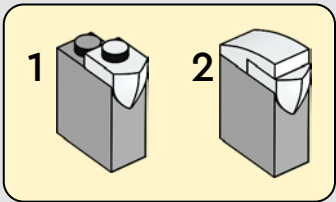



1x



1x

751

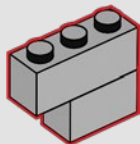

1x



1x

752

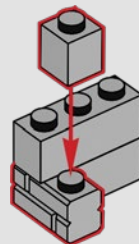

1x



1x

753

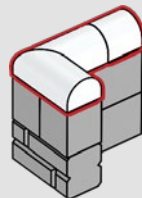

7/49



636

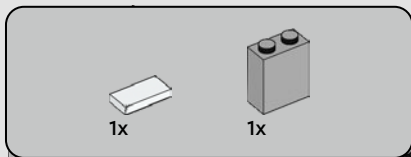

750

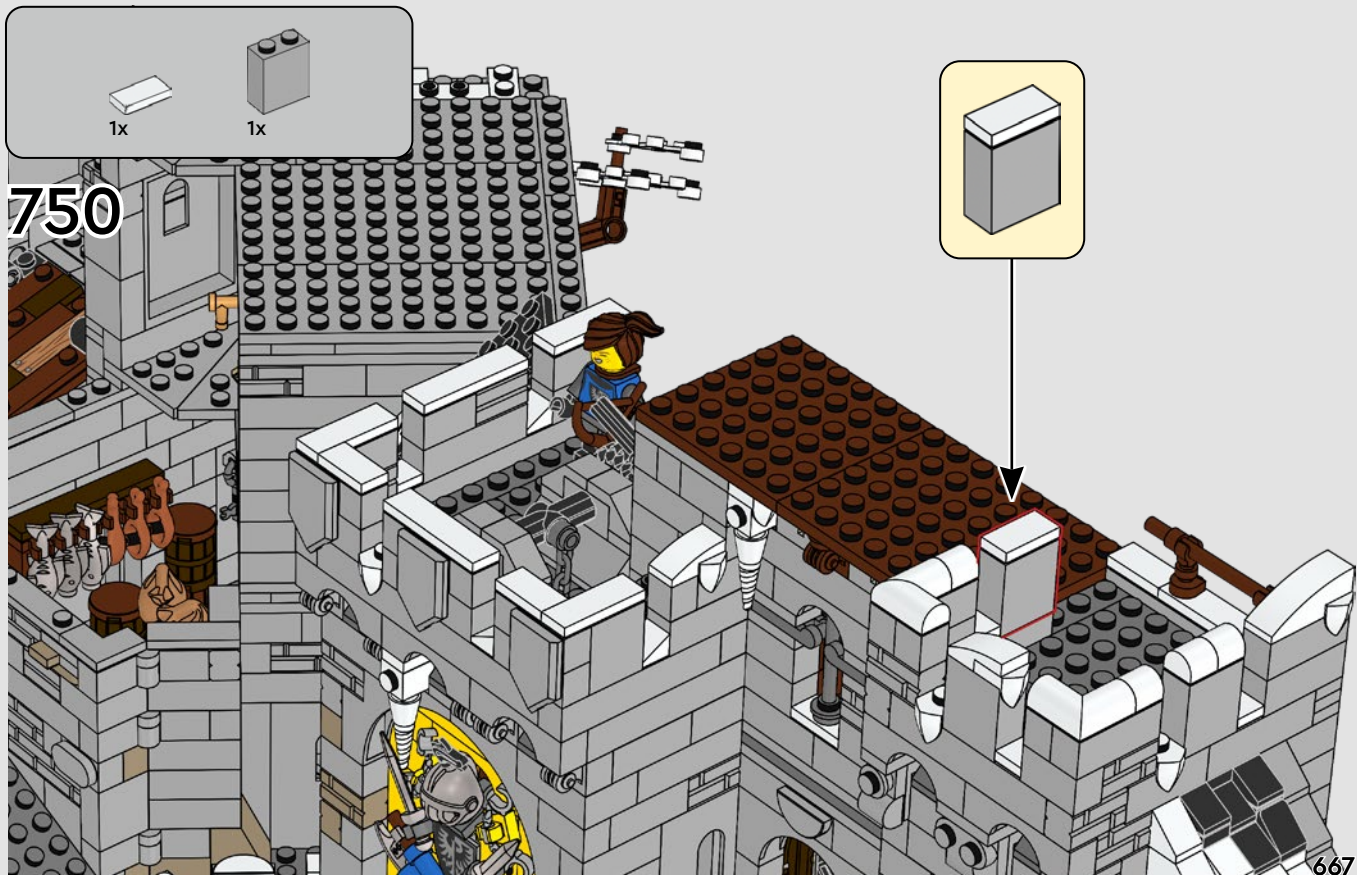
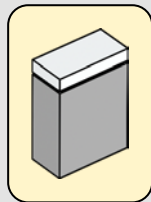

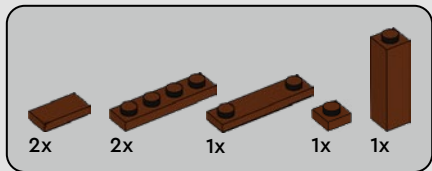

751

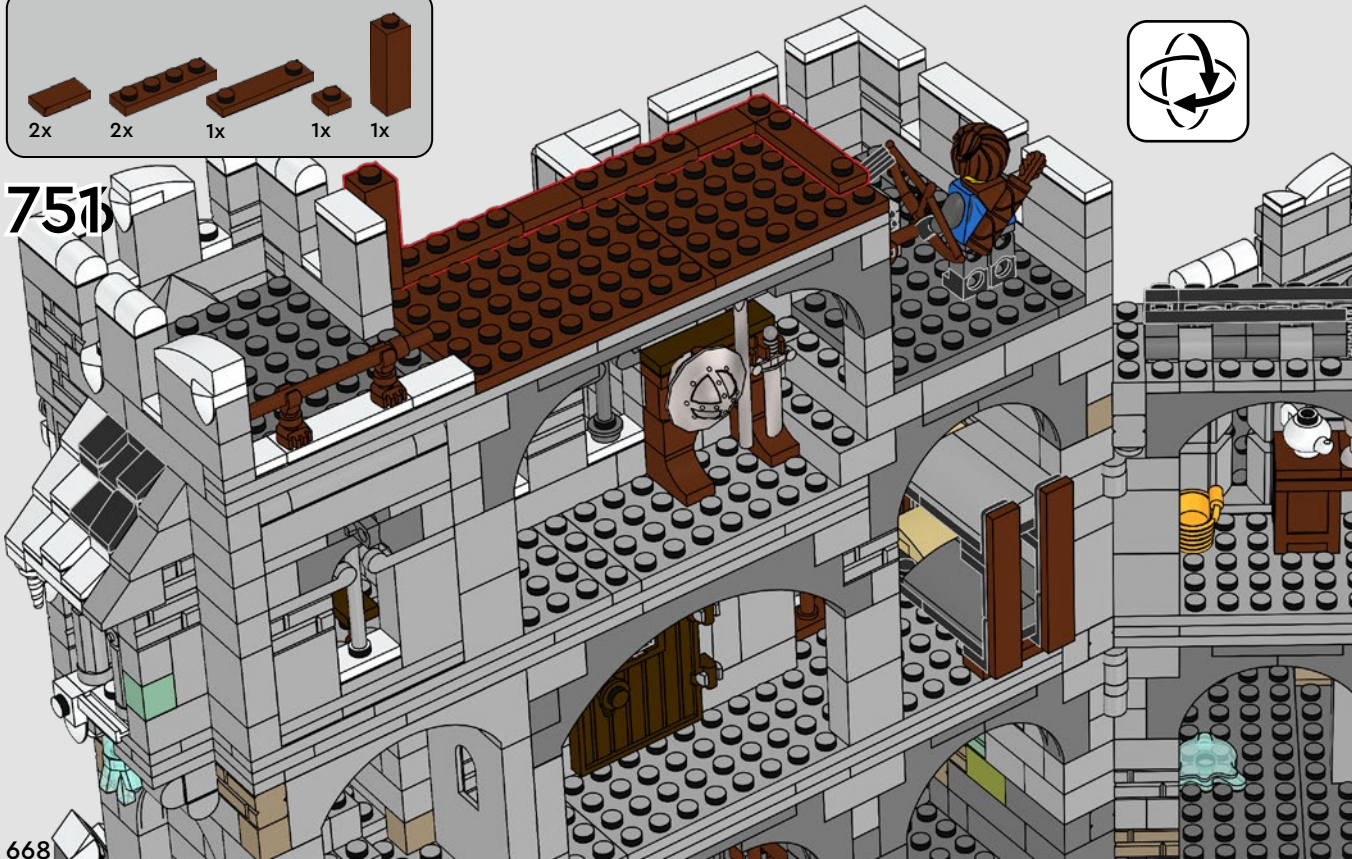

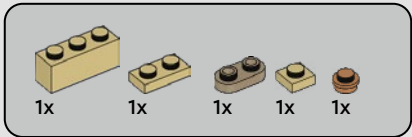

757

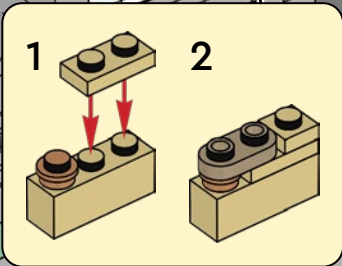
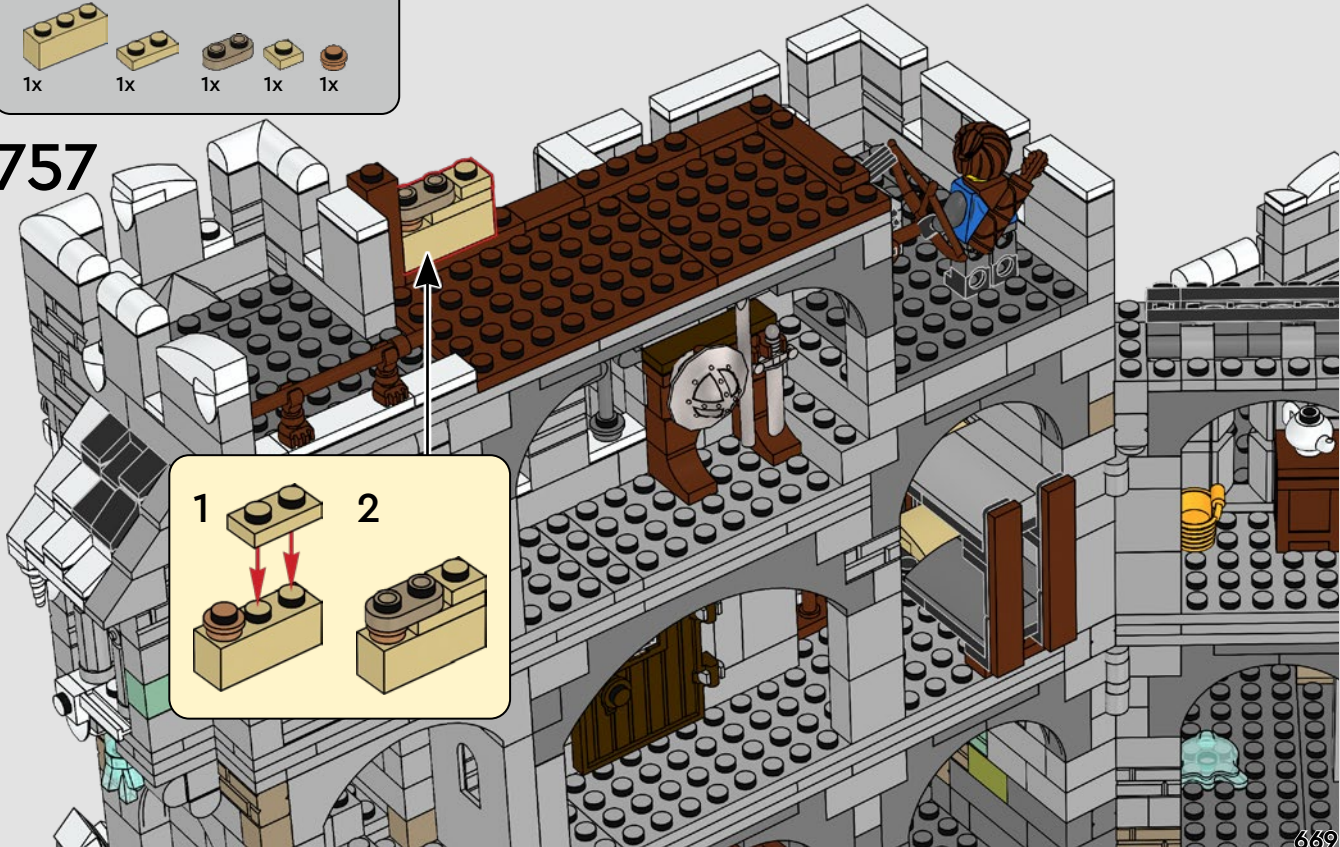

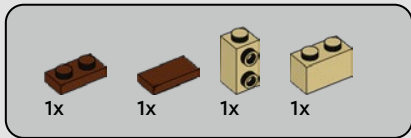

758

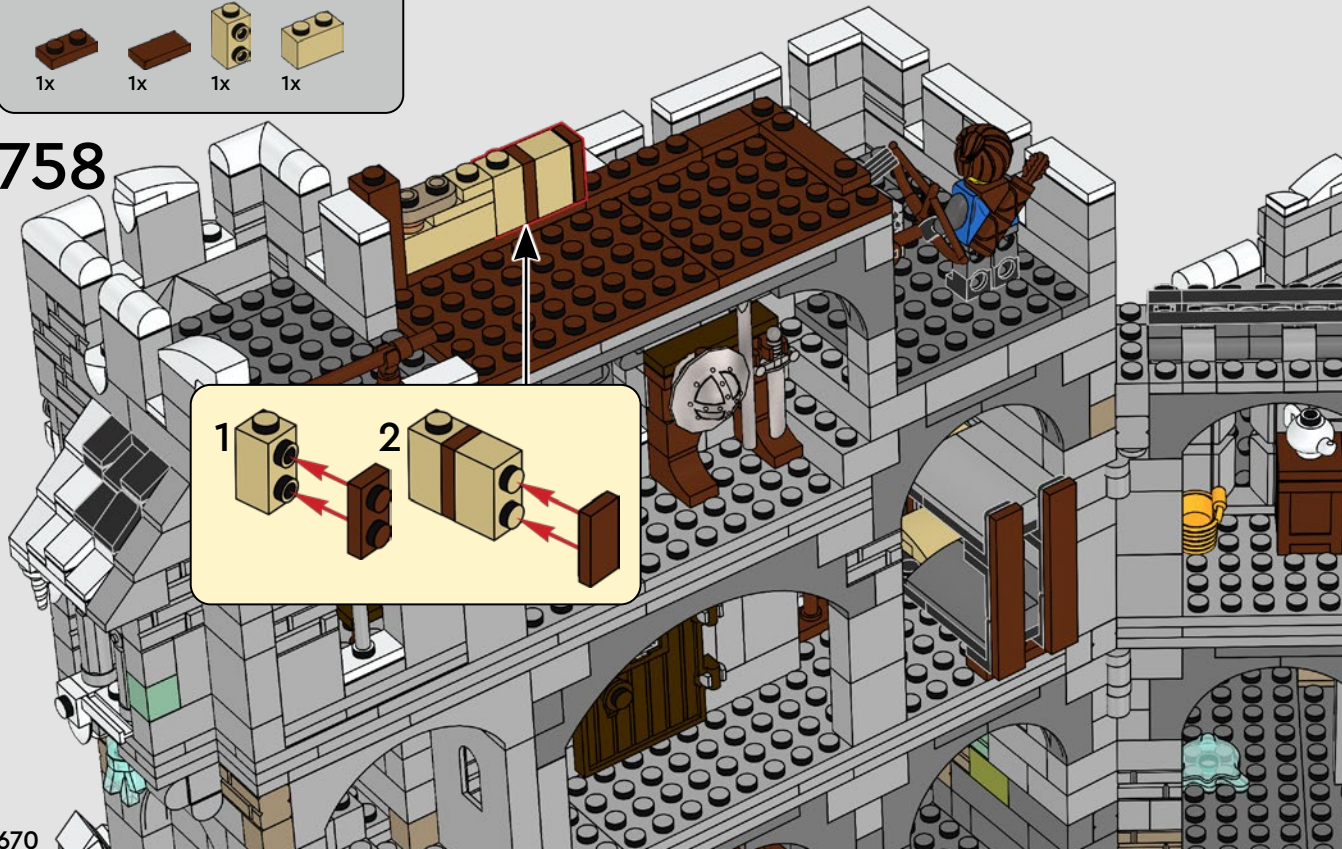

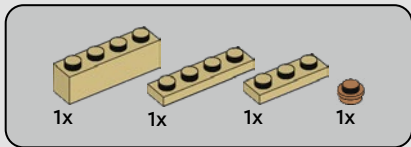

759

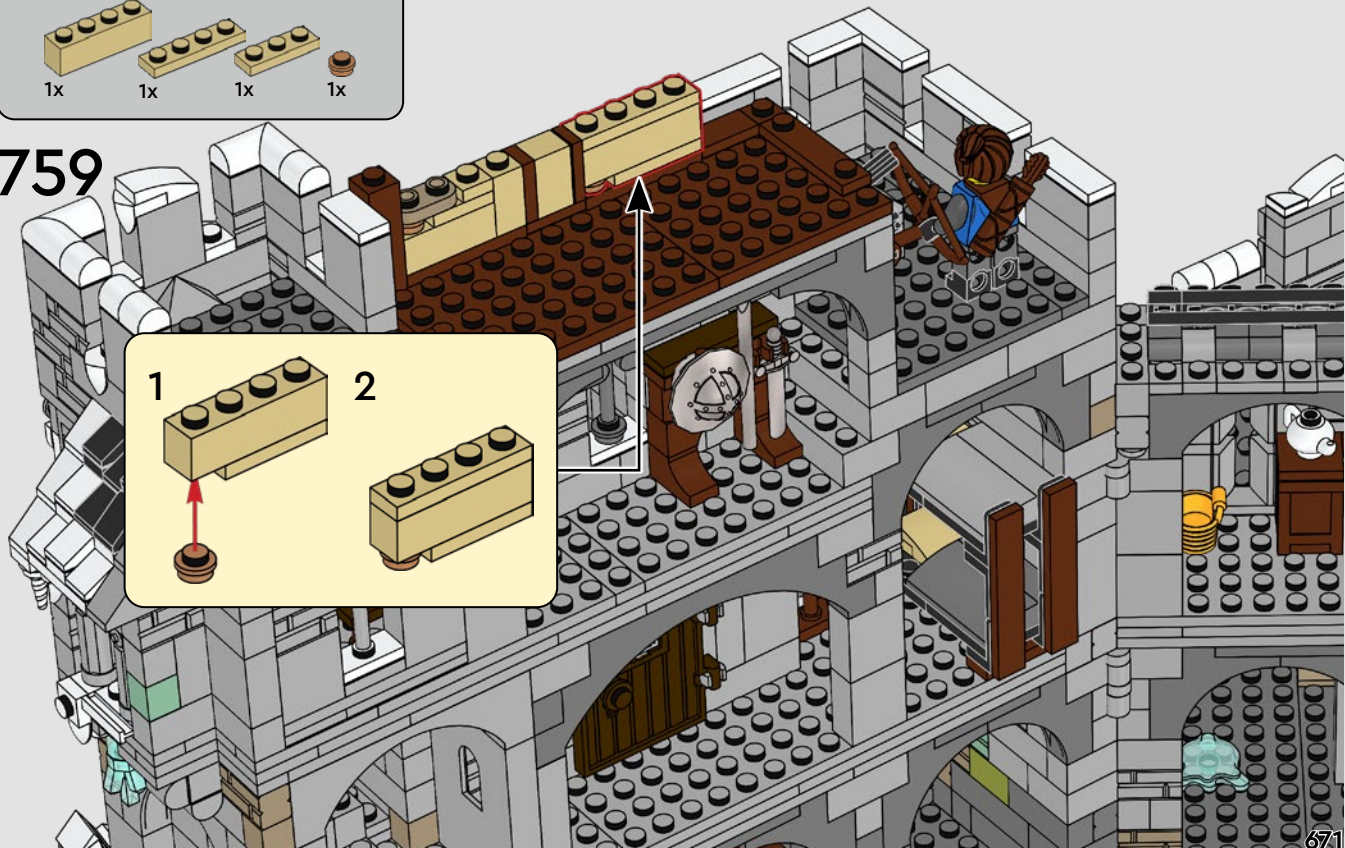
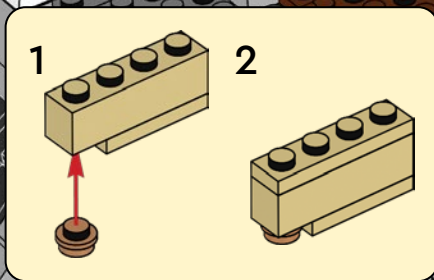

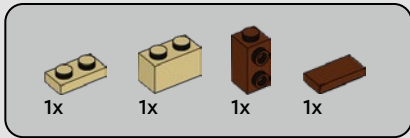

760

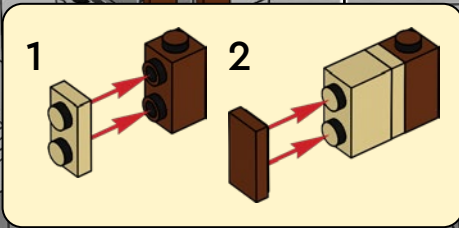
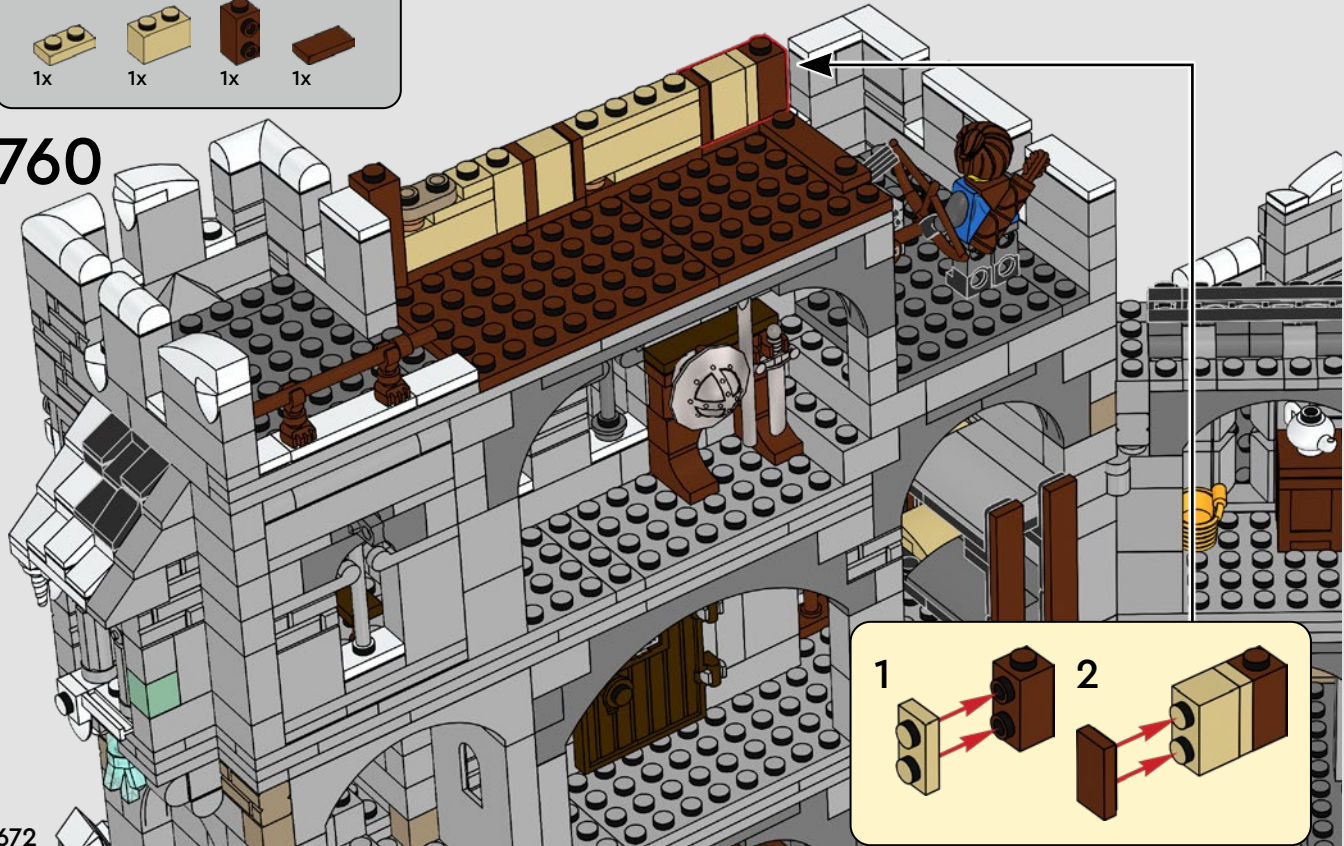

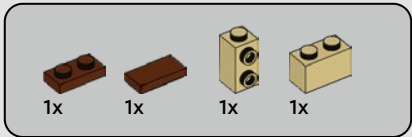

761

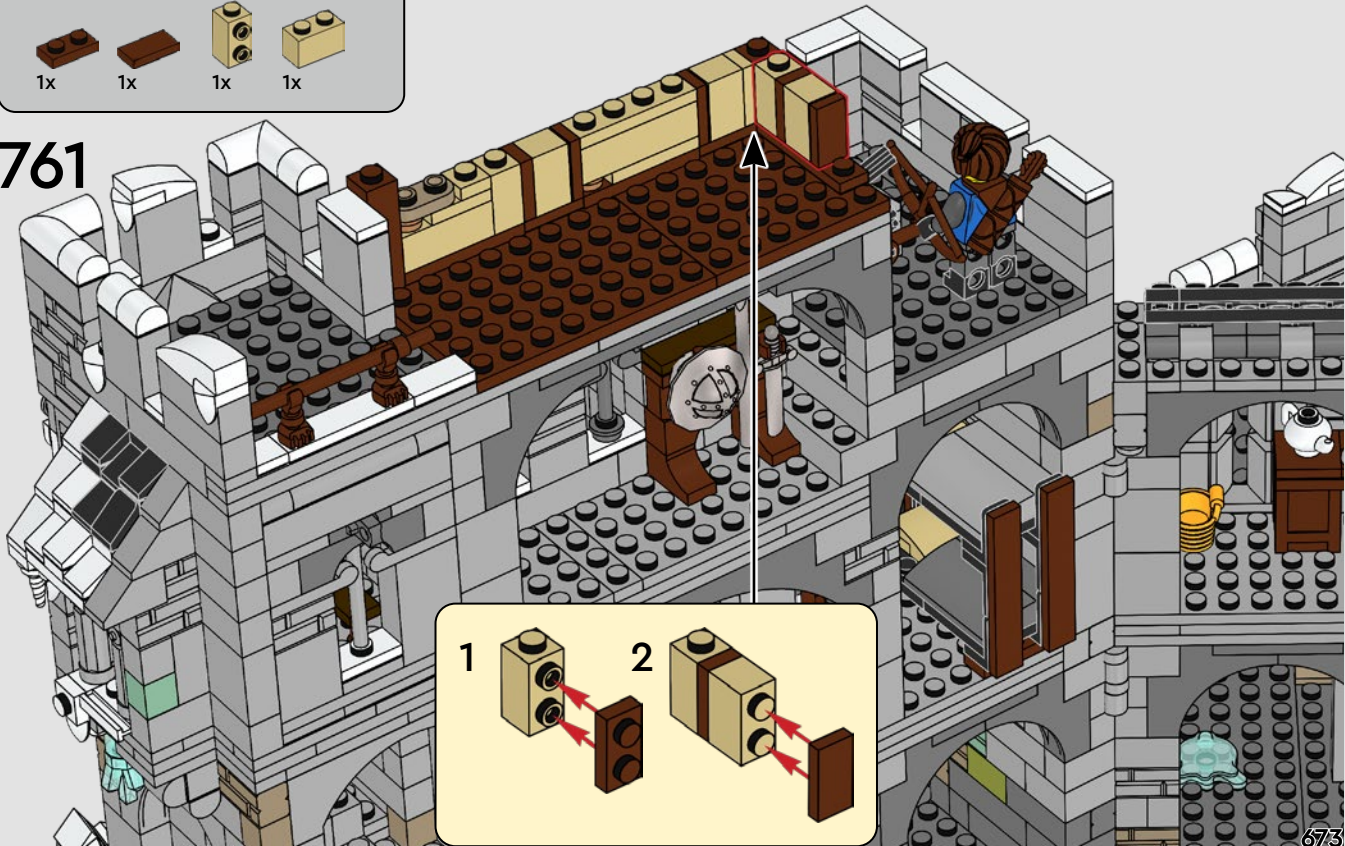



762

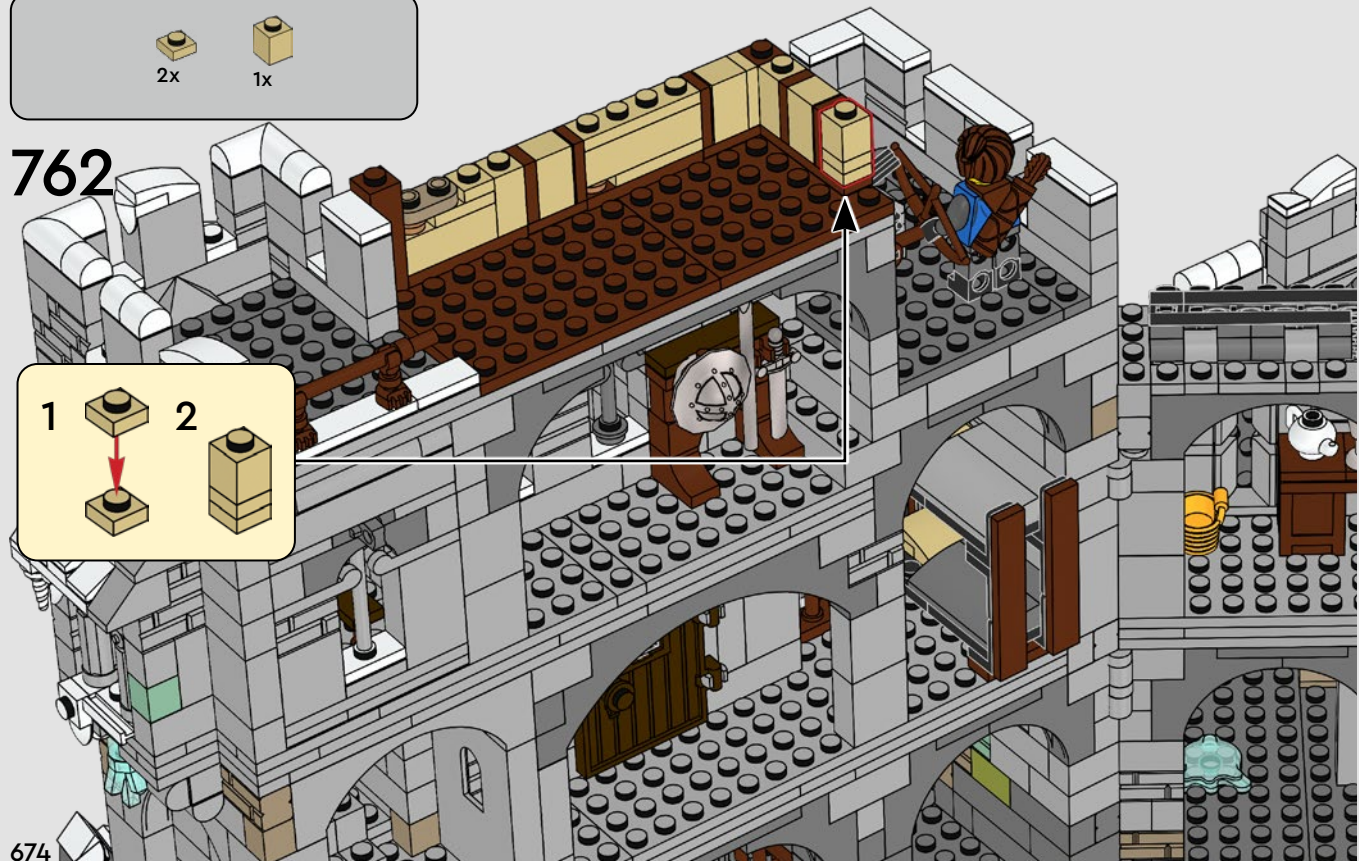
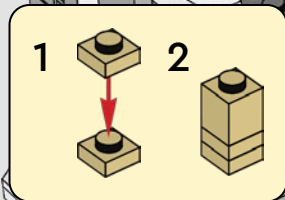

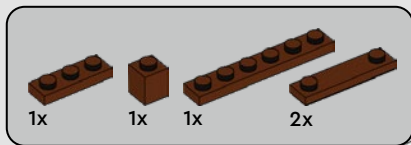

763

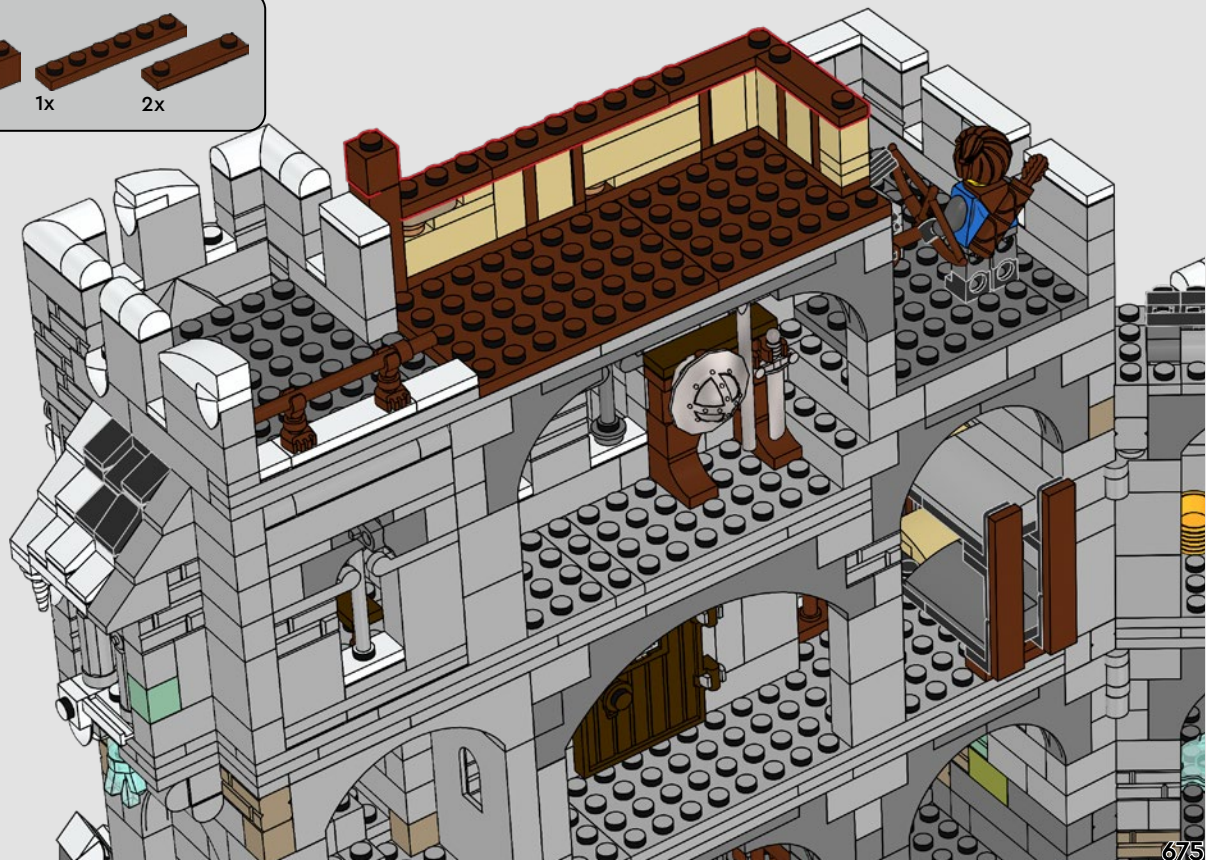

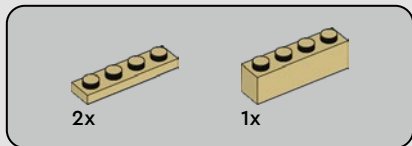

764

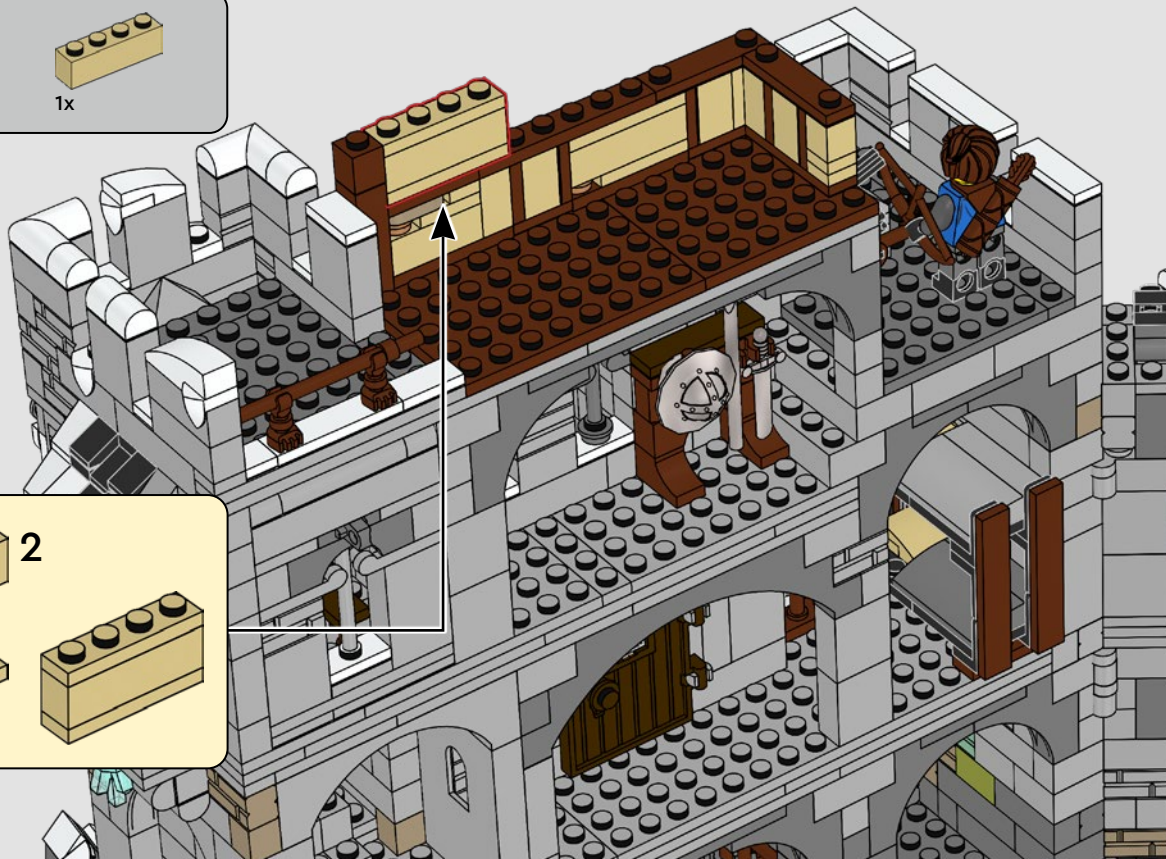
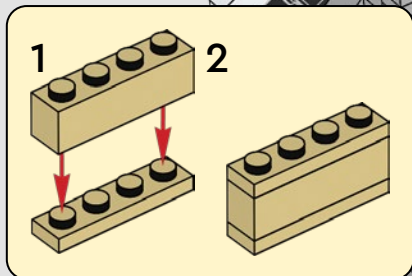

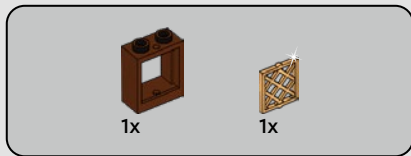

765

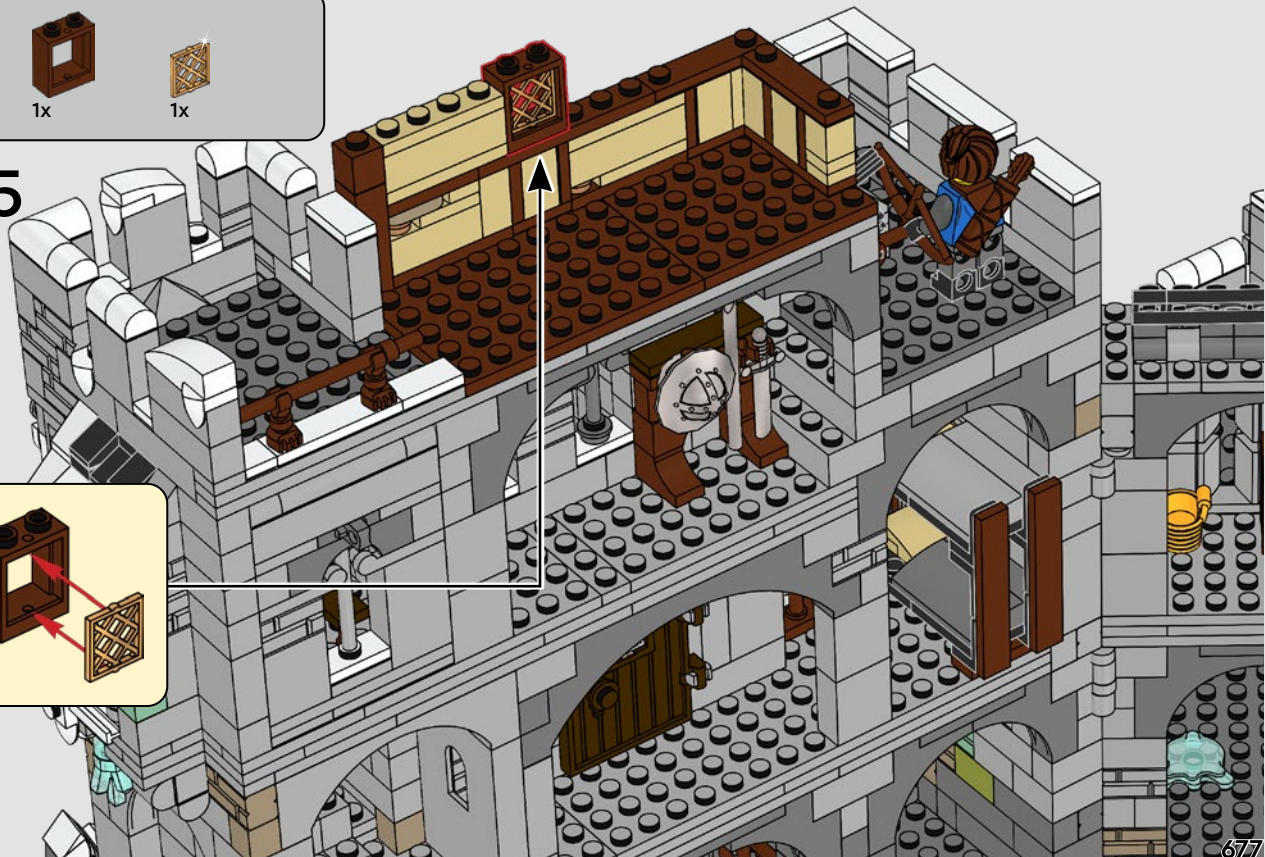
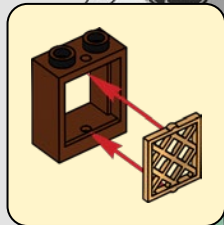

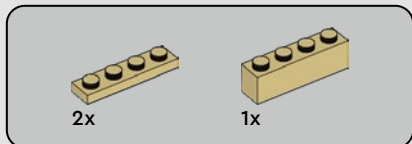

766

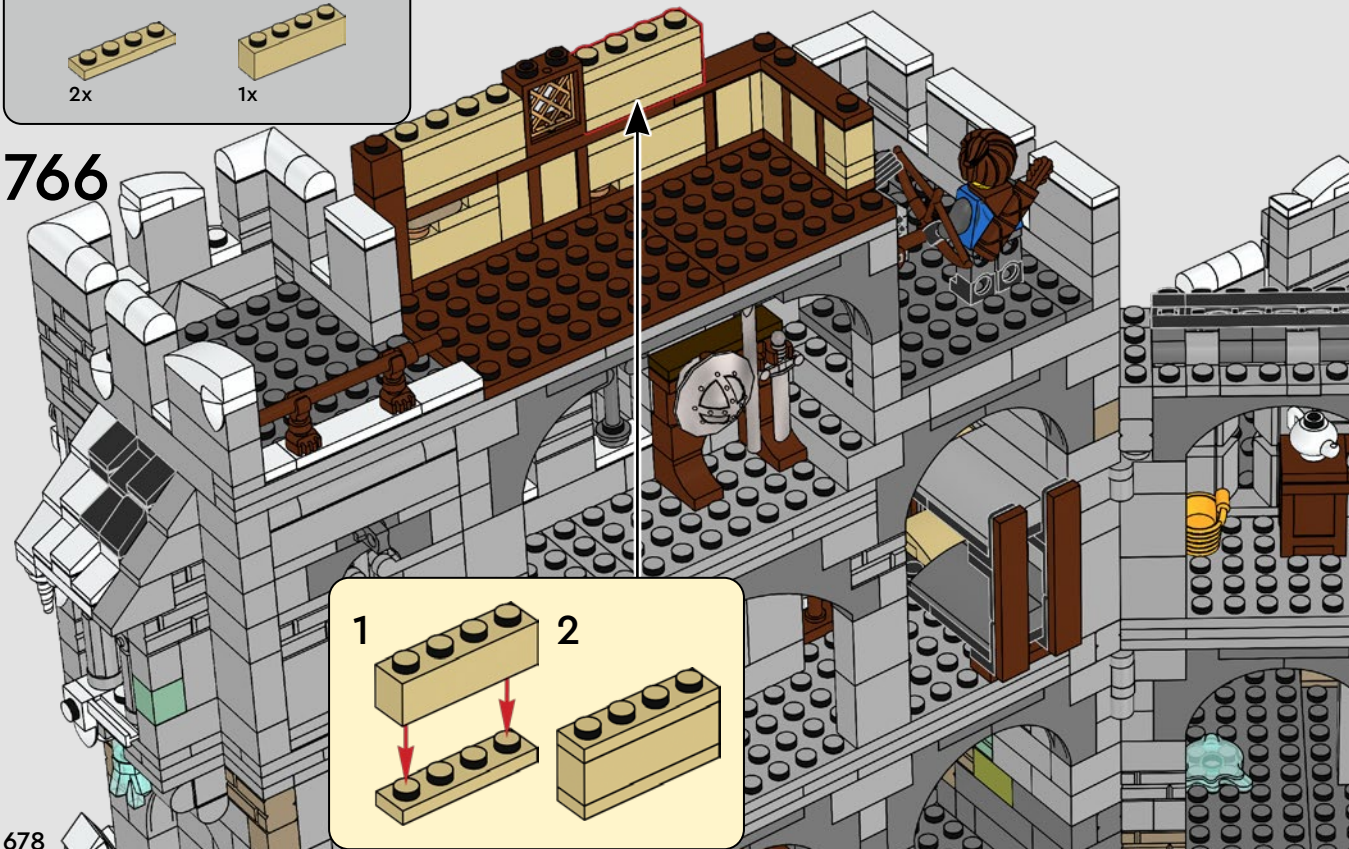

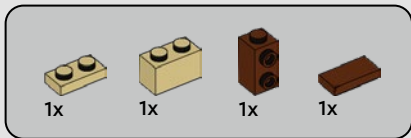

767

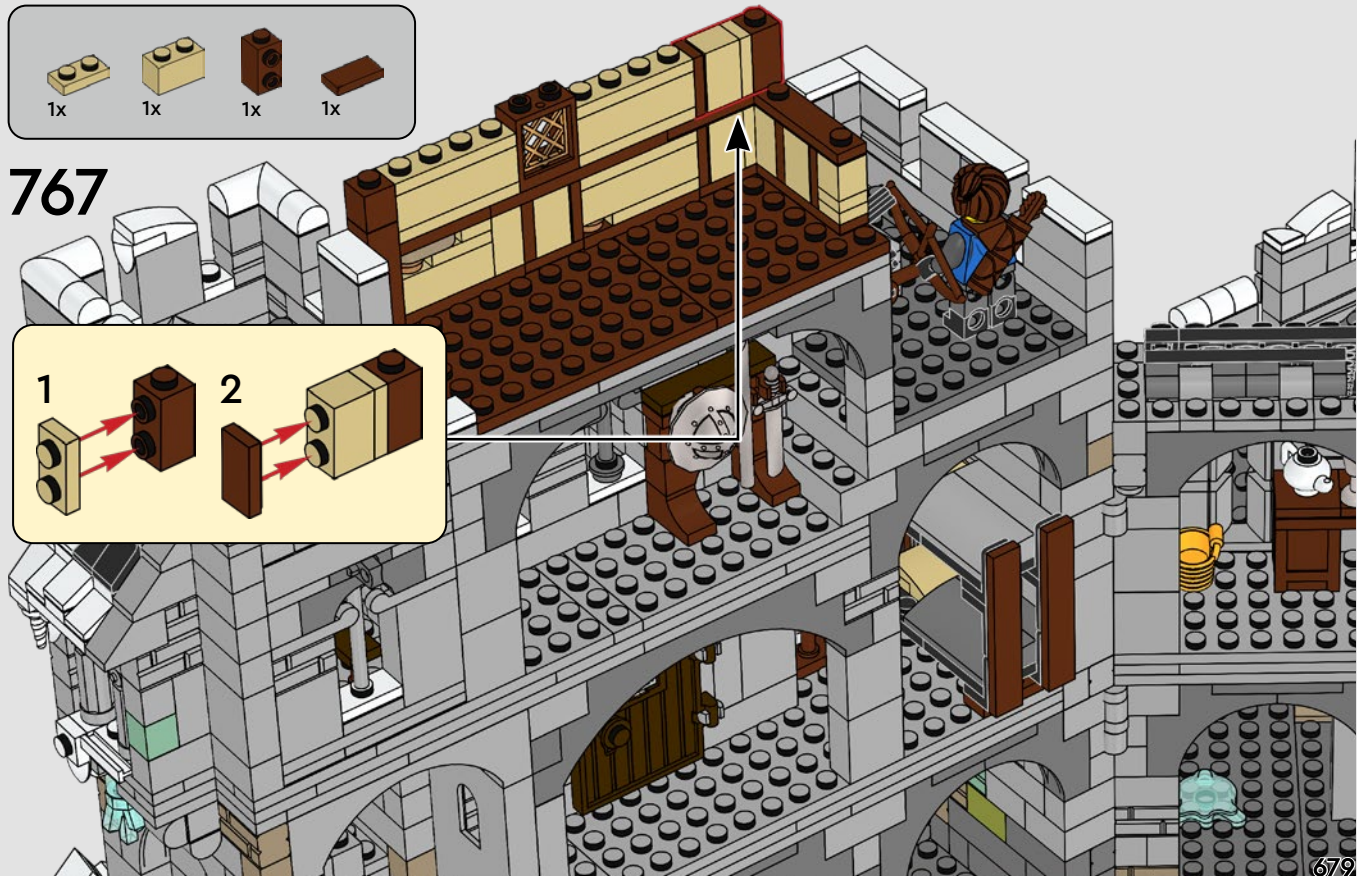
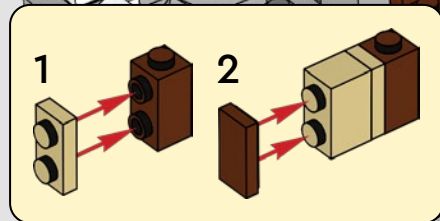

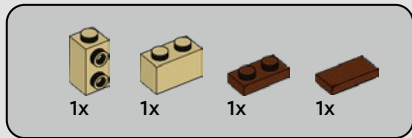

768

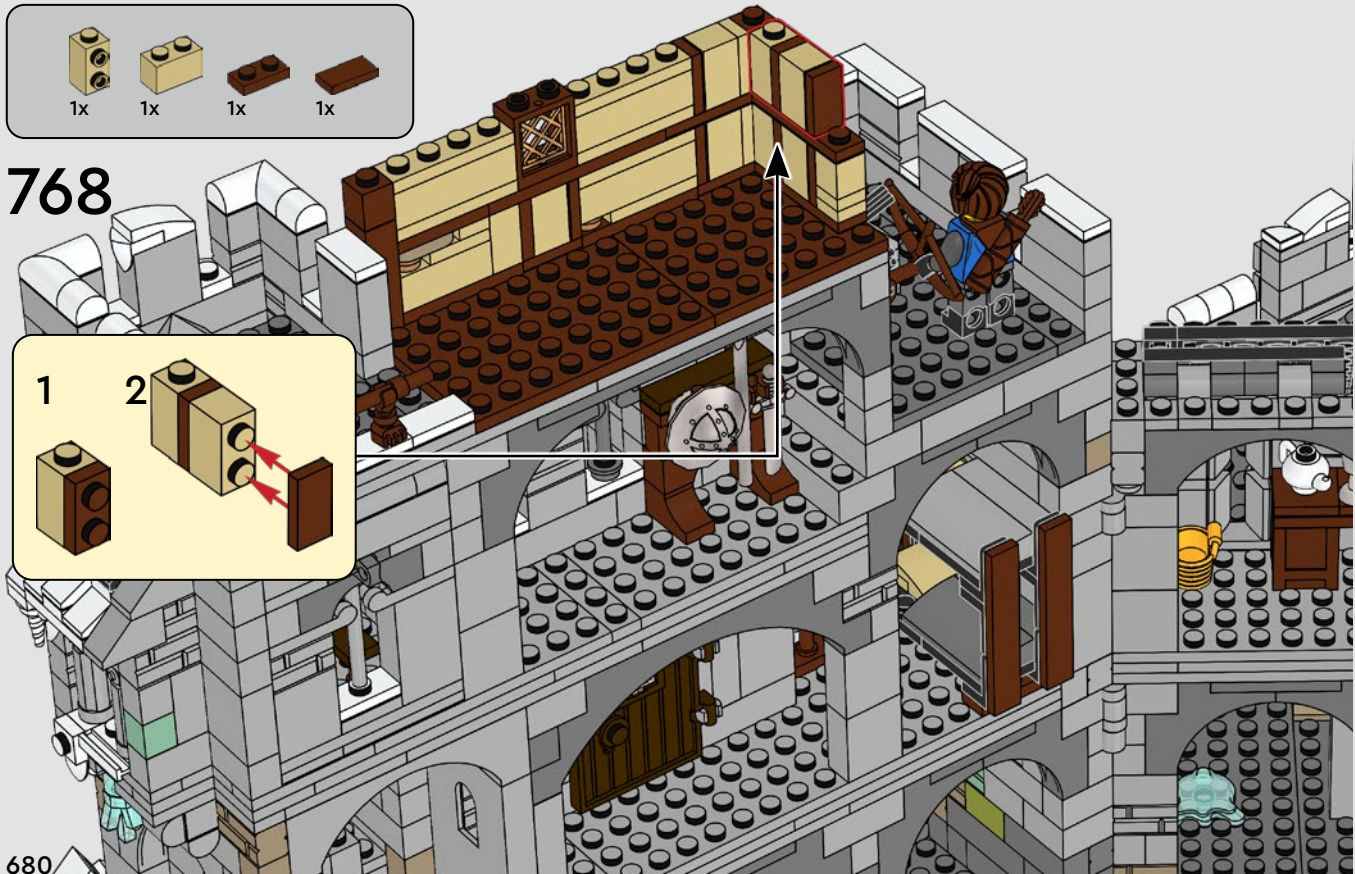
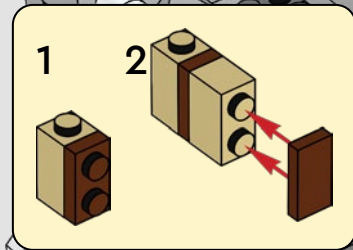

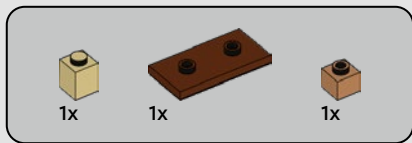

769

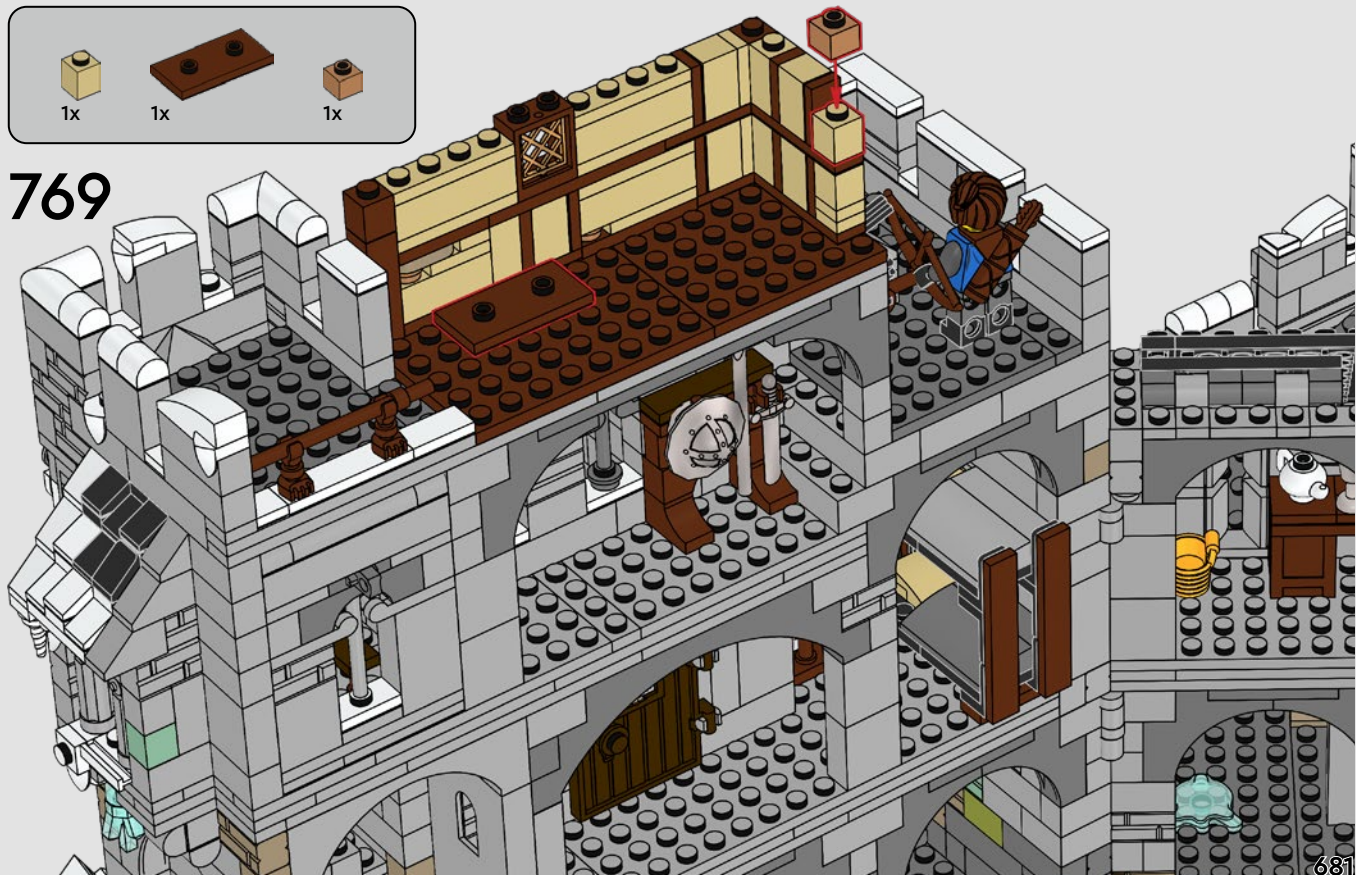

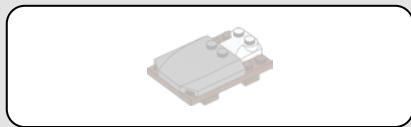

771

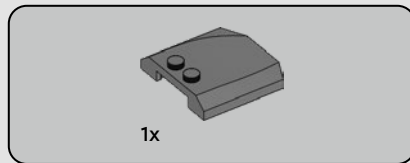
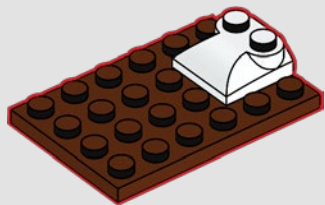

772

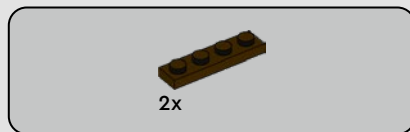

773



774

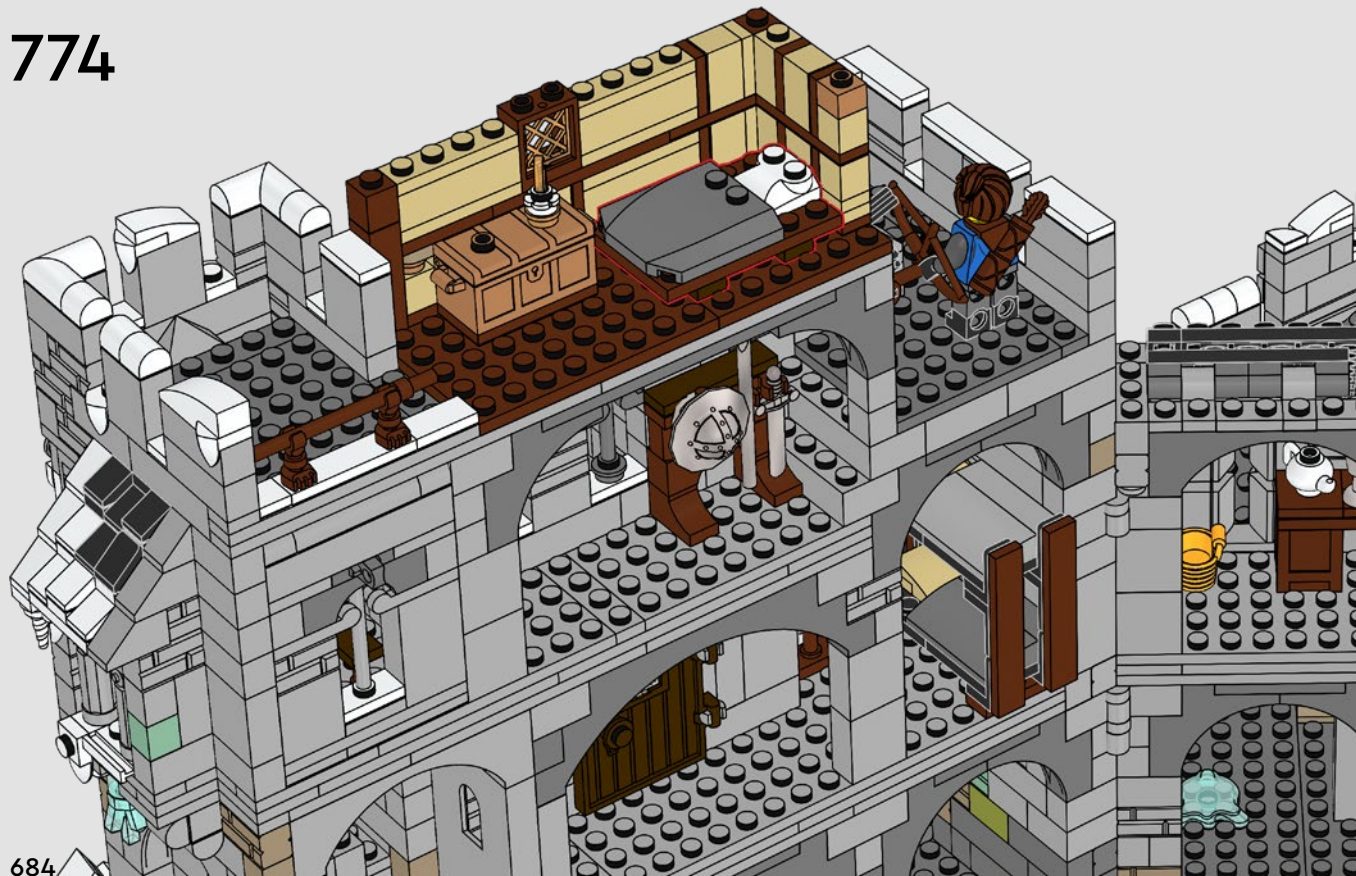

684

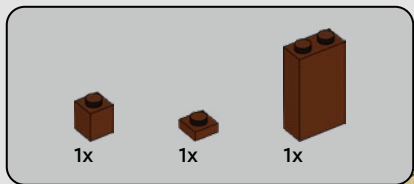

770

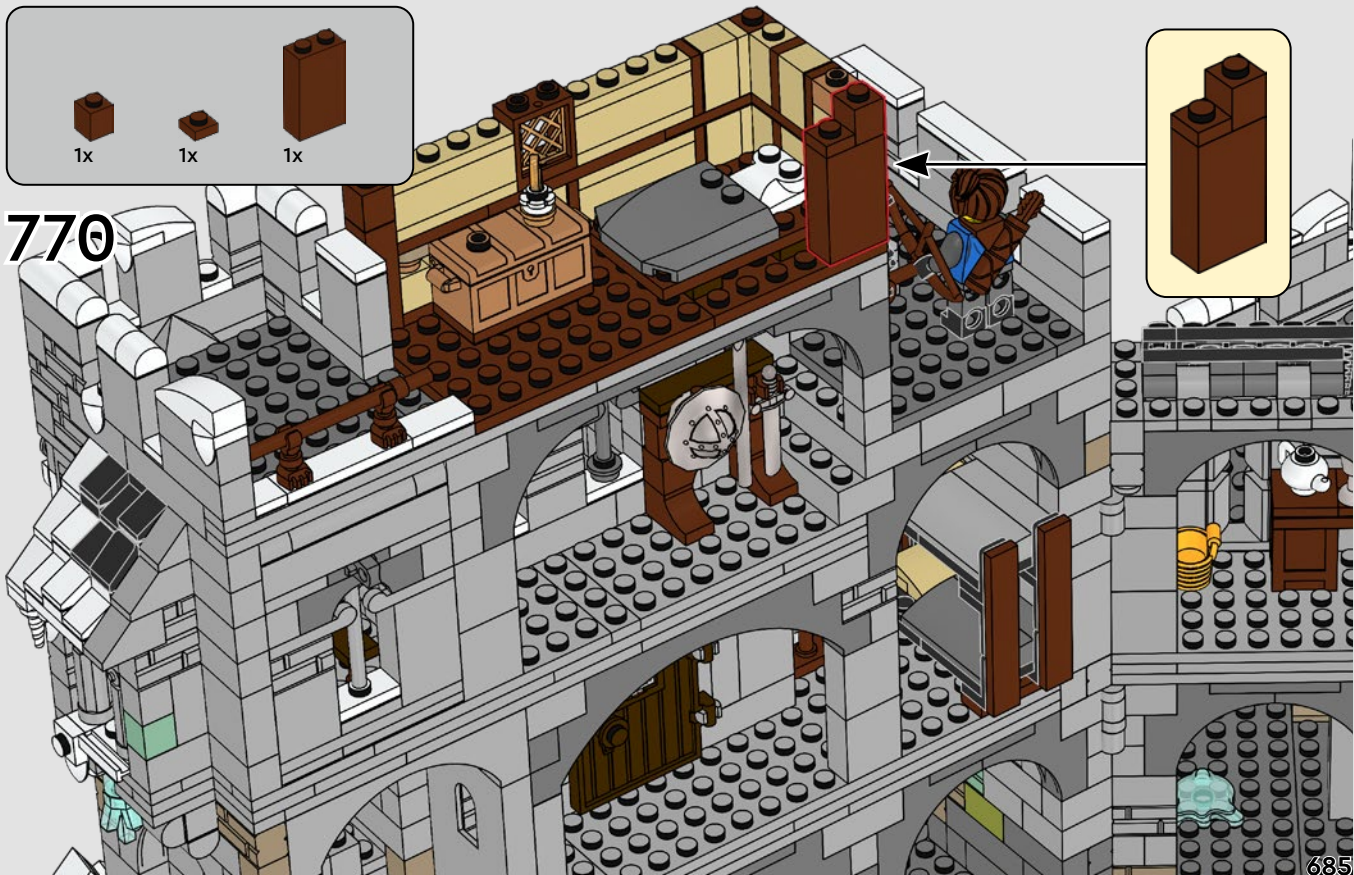
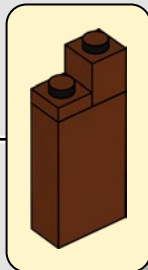

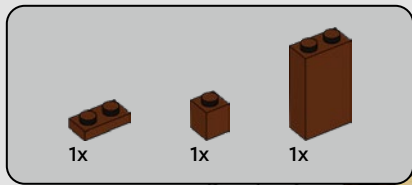

77

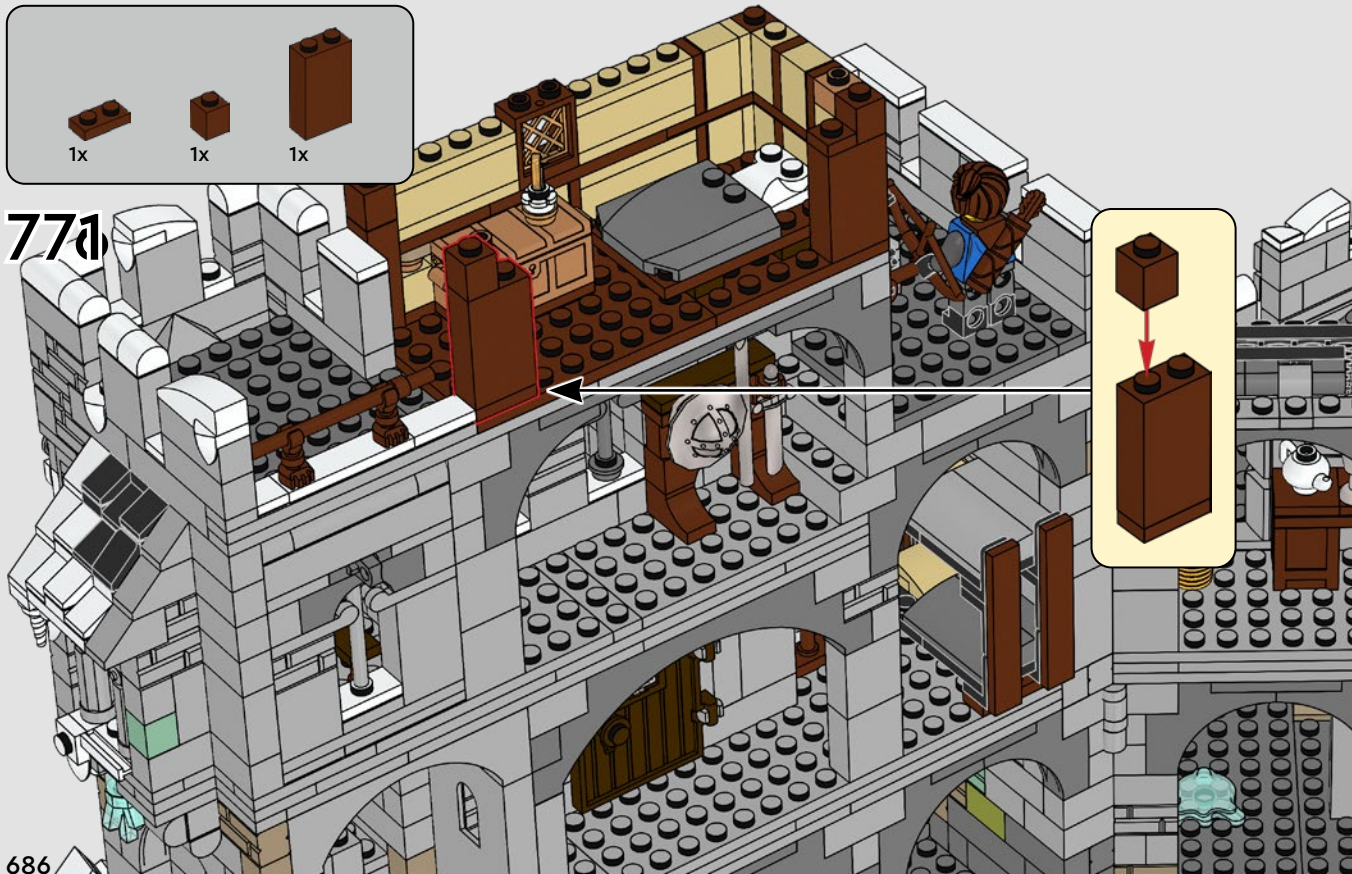

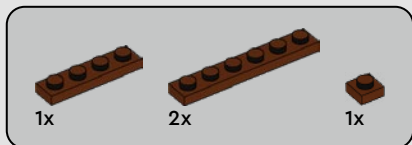

777



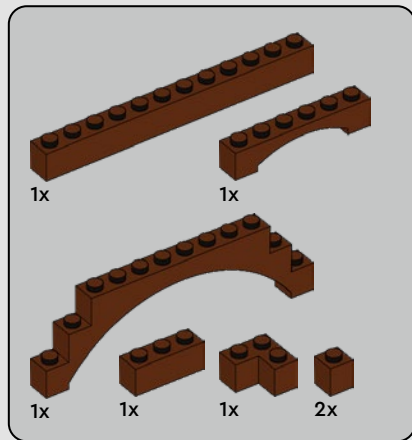

778

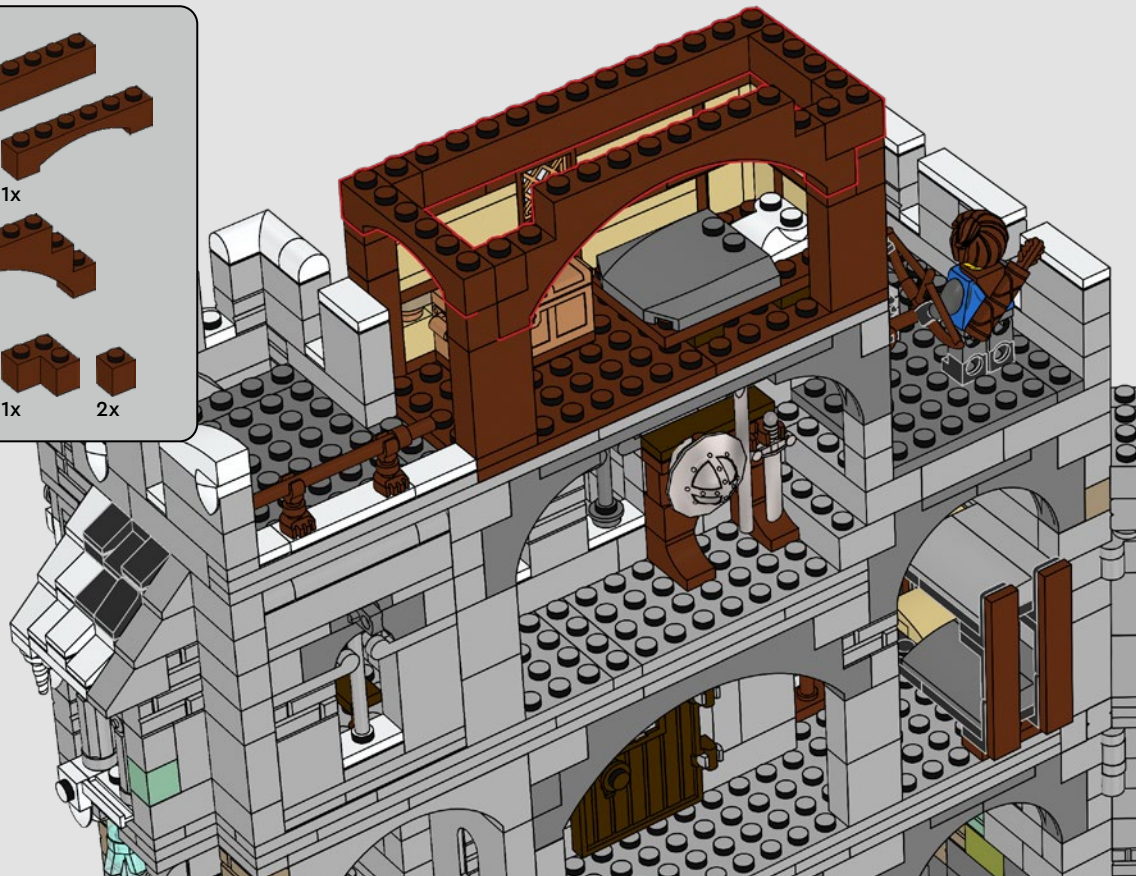

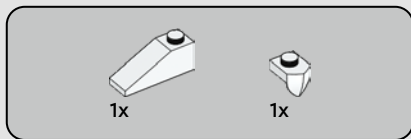

779

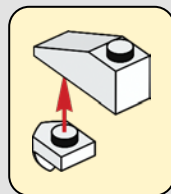



780

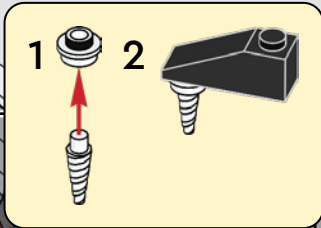
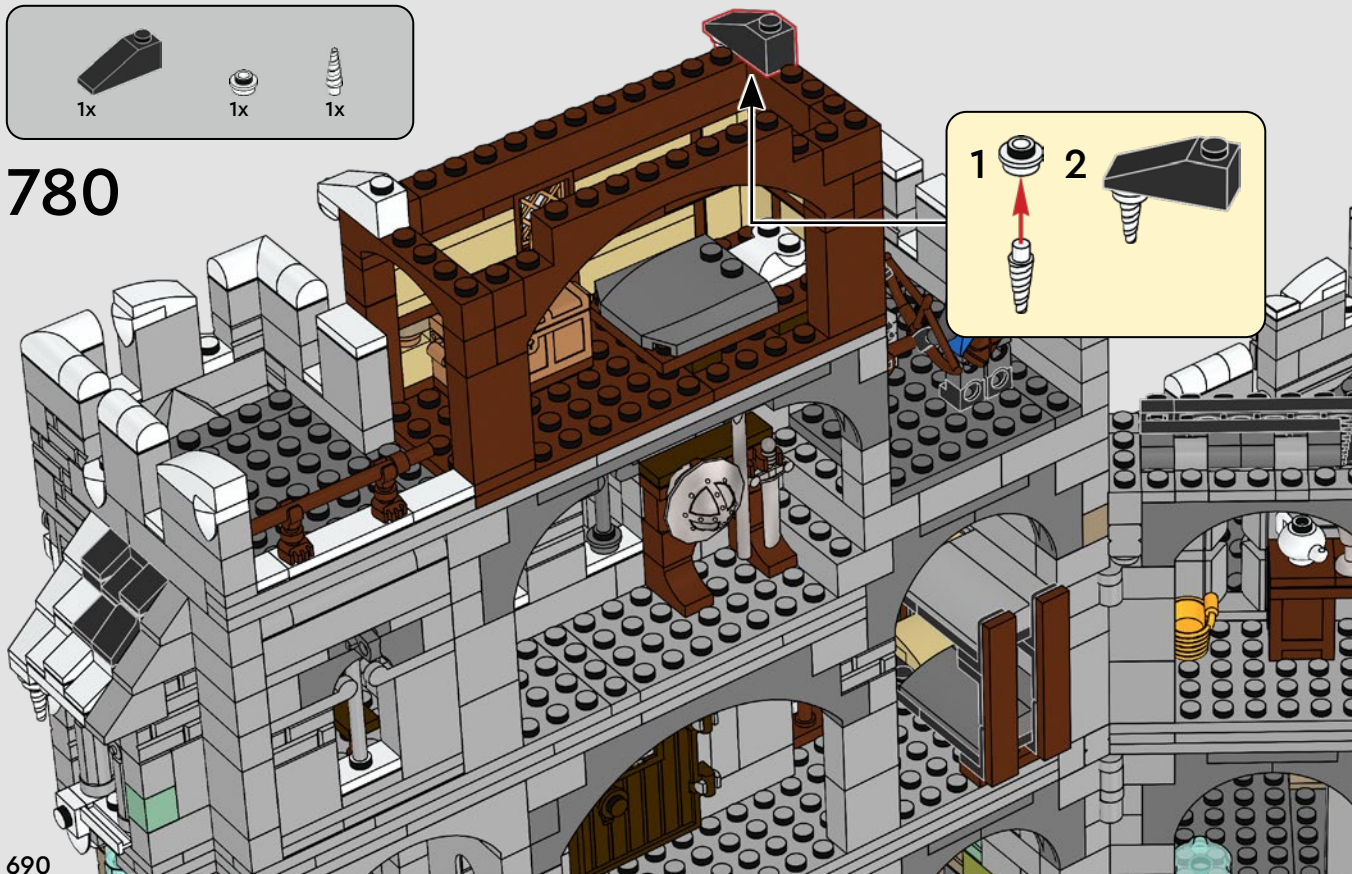



4x

781

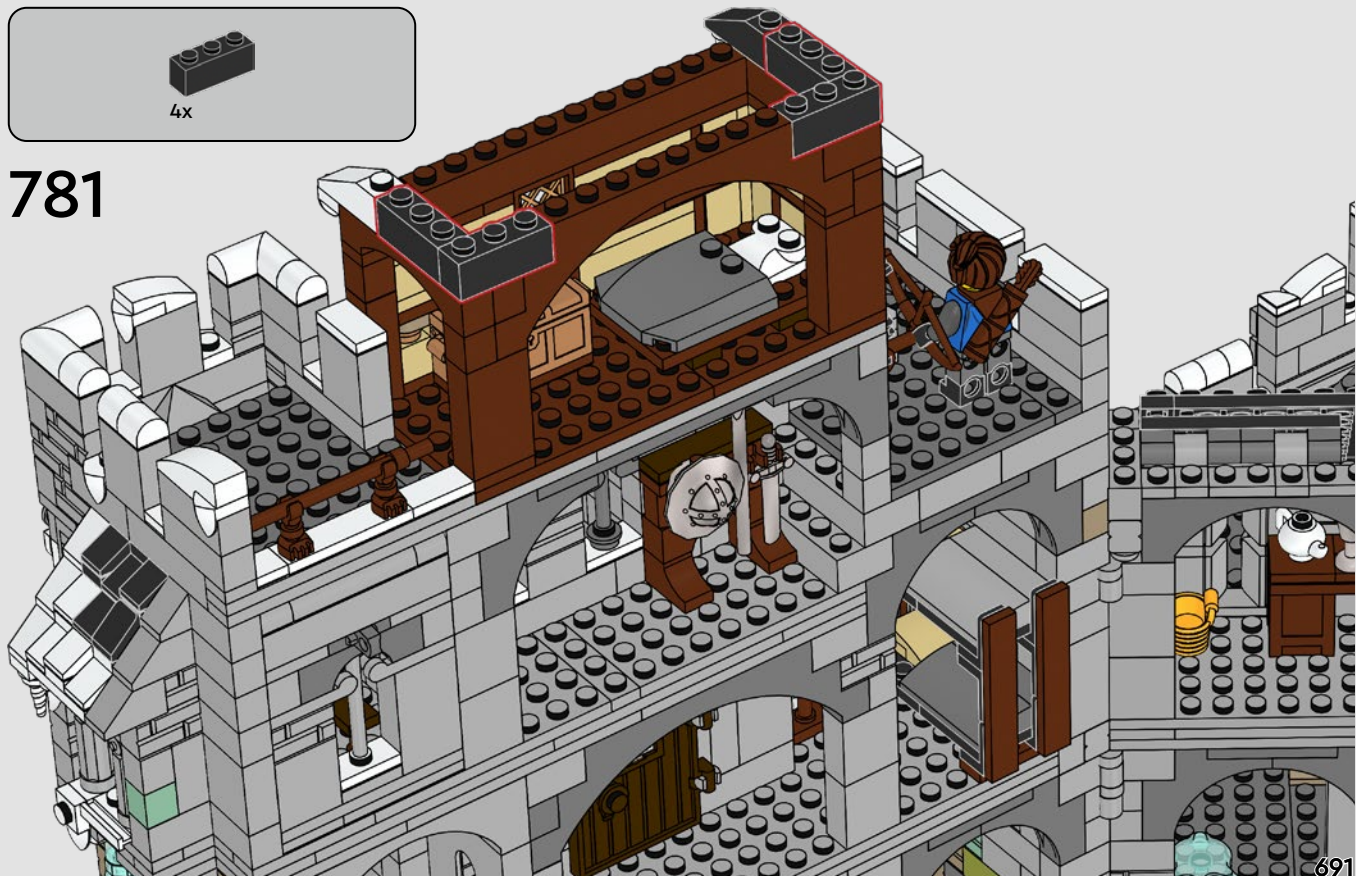

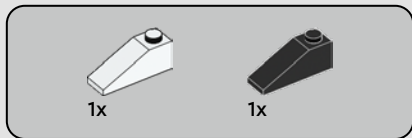

782

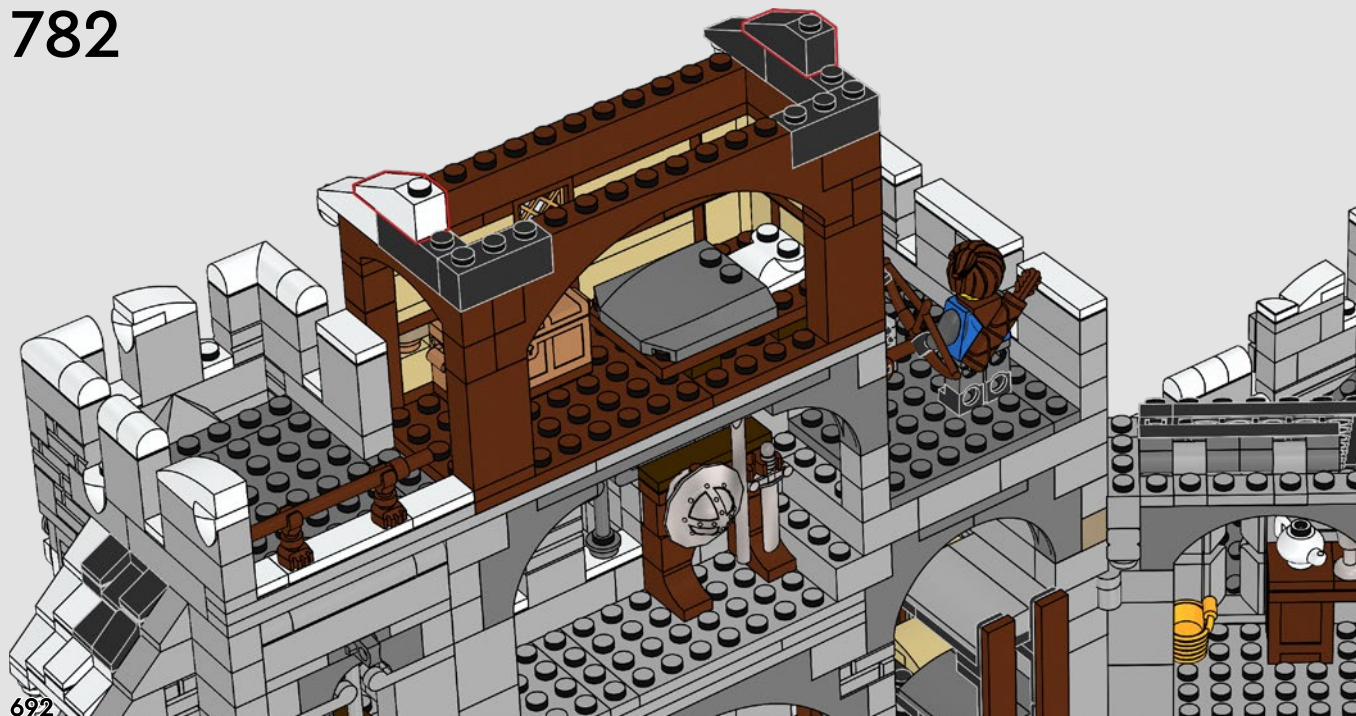

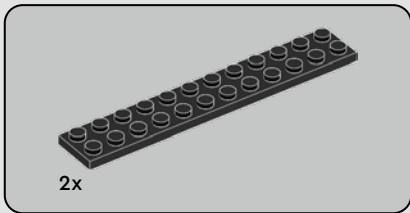
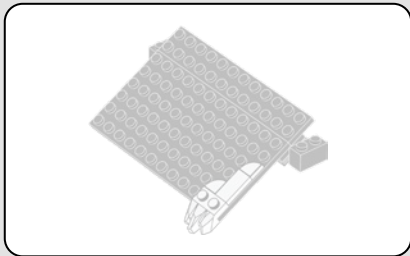

2x

783

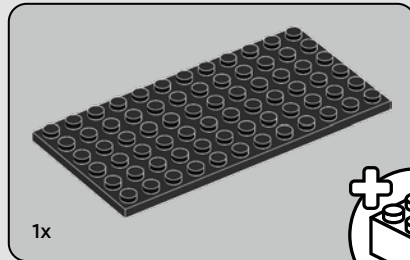
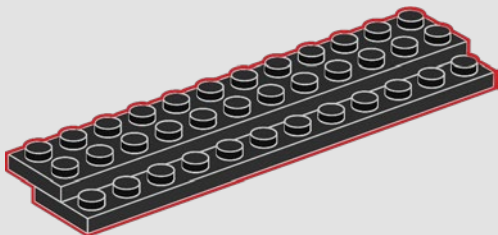

1x

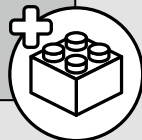

784

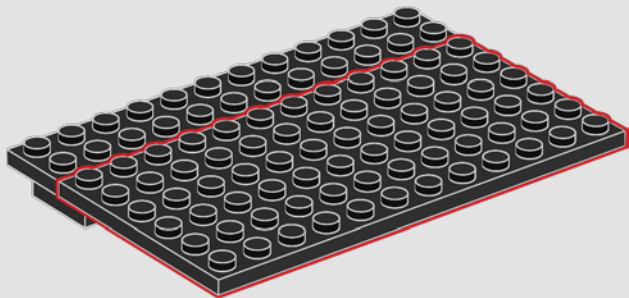



785

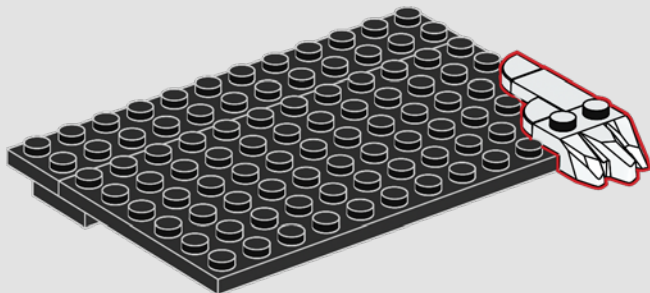



2x



2x

786

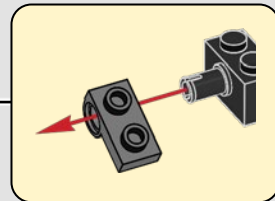
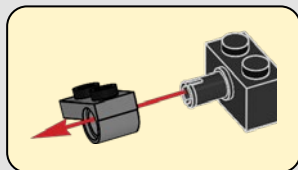
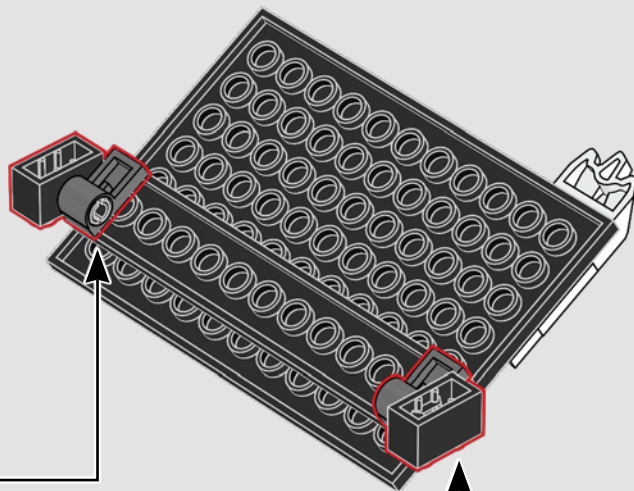

787

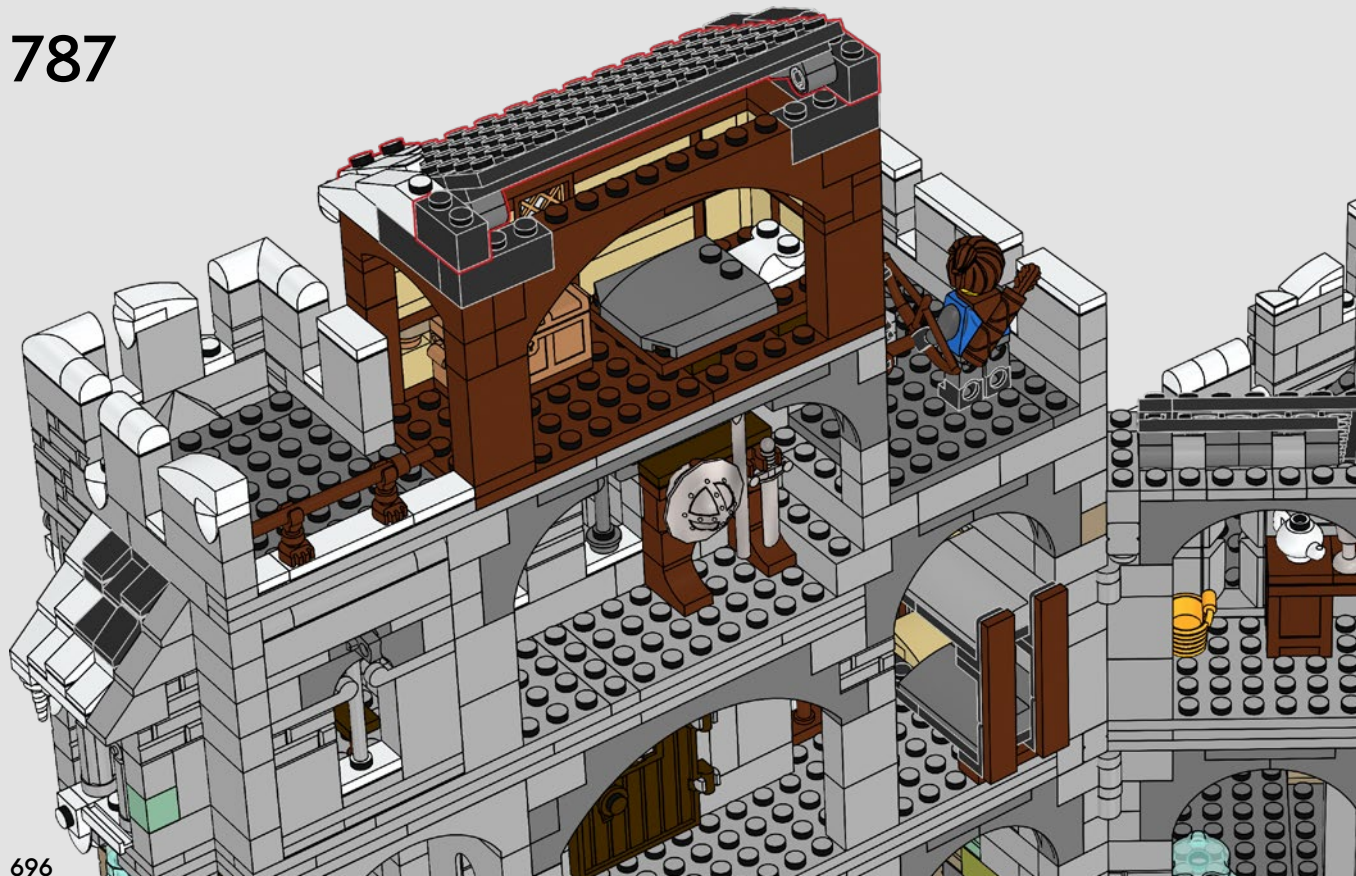

696

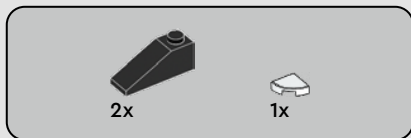

788

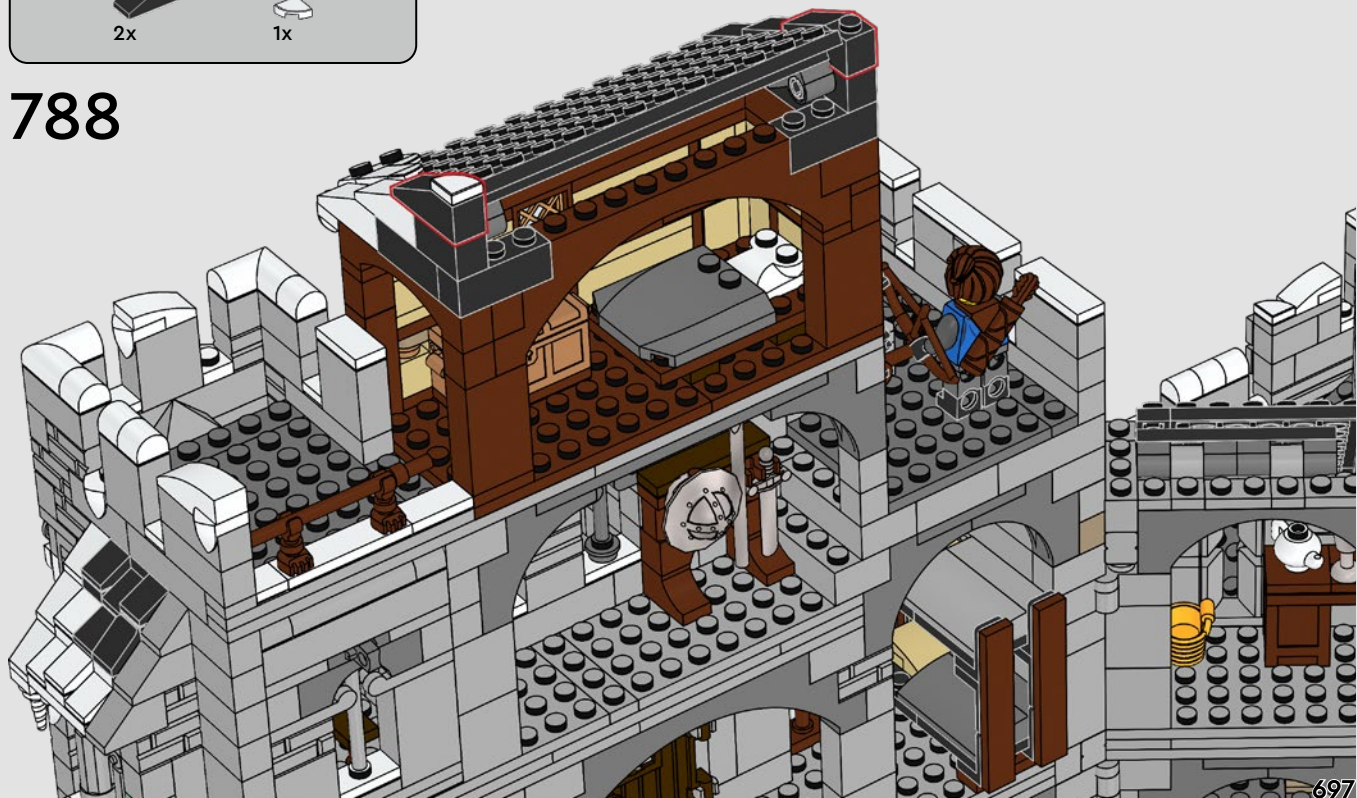





1x

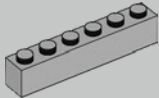

1x



1x

784

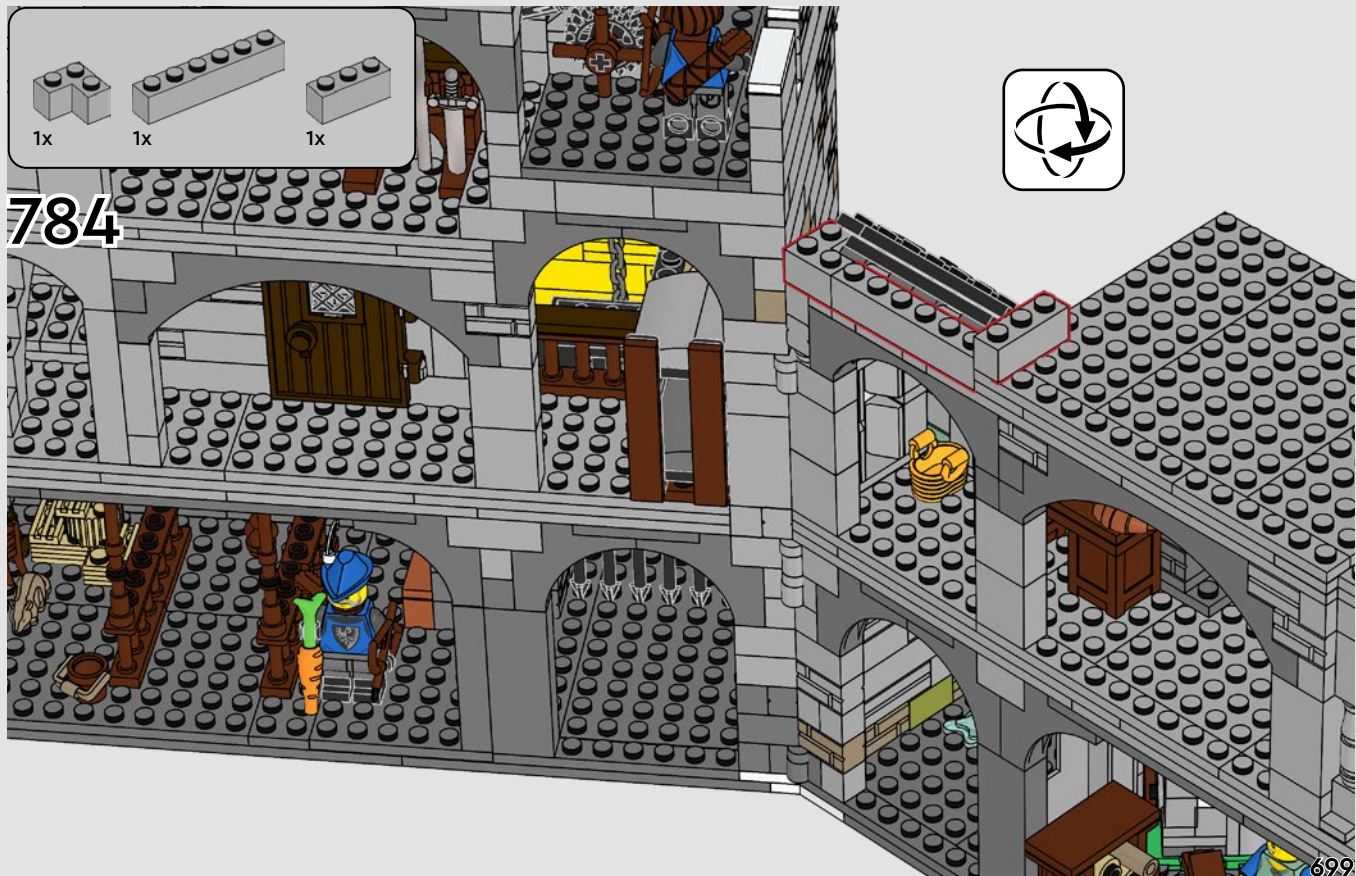

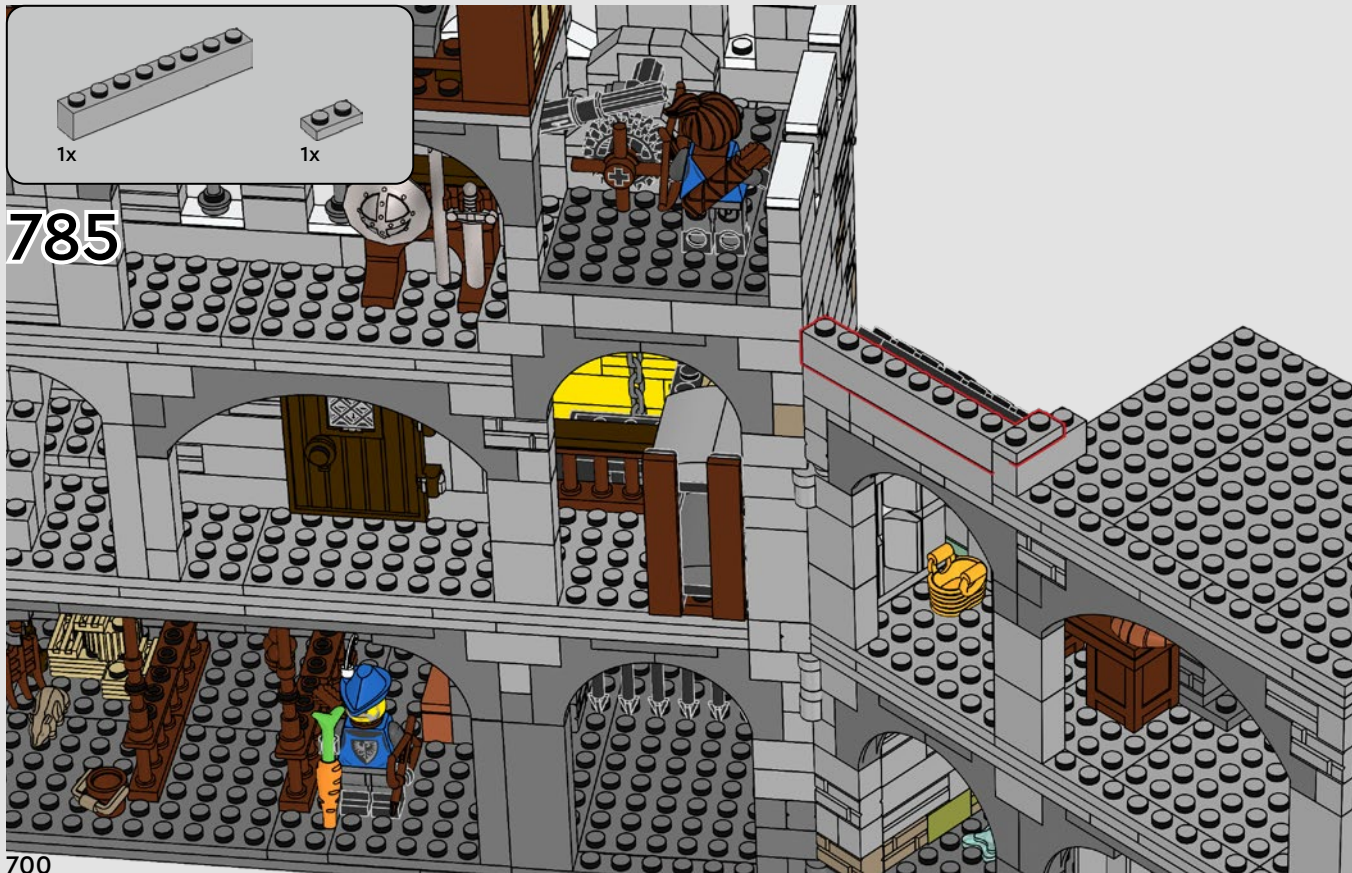



1x



1x

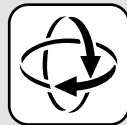

791



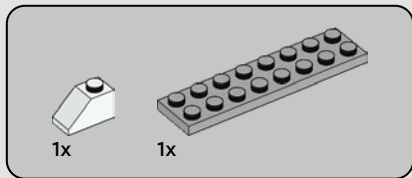

792



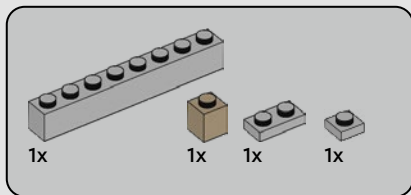

793



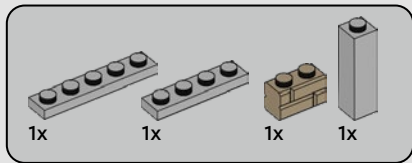

794

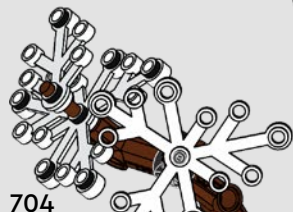

704



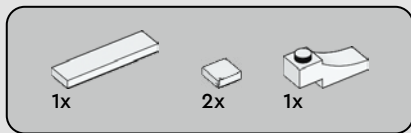

795



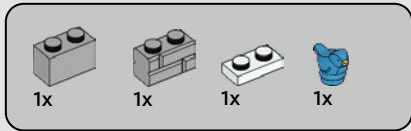

796

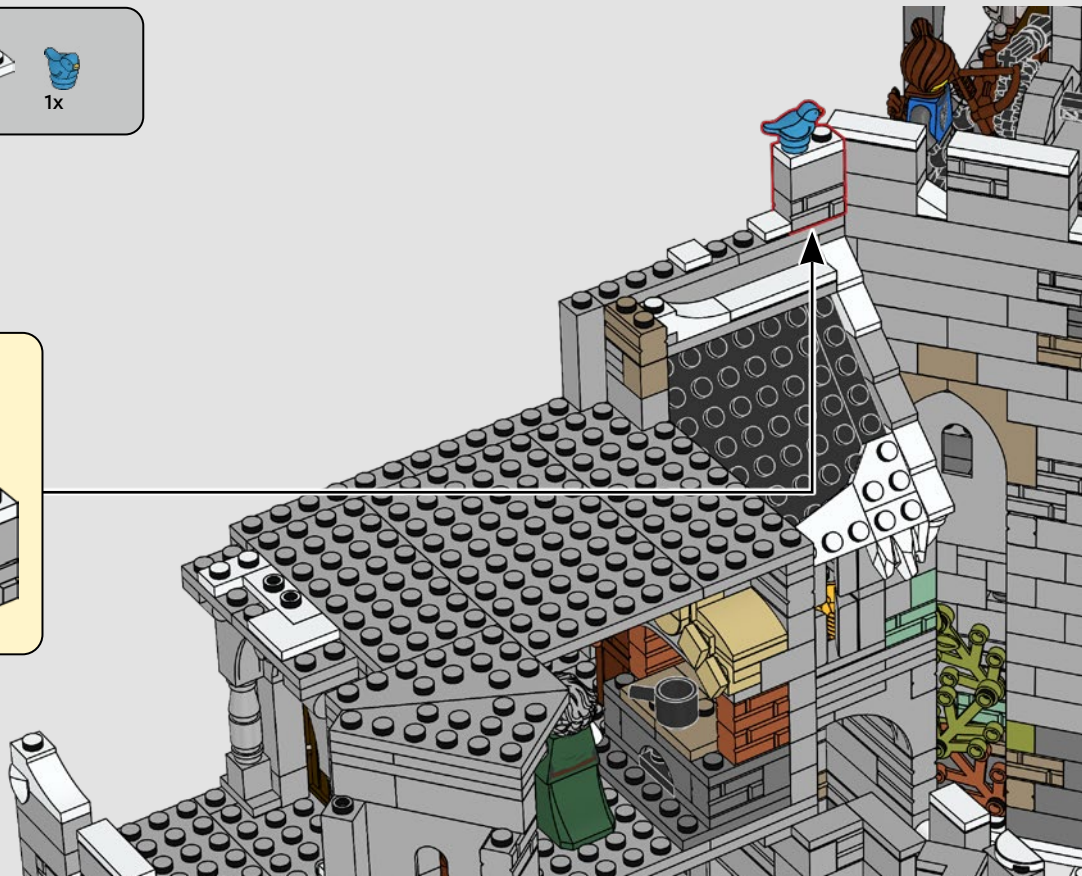
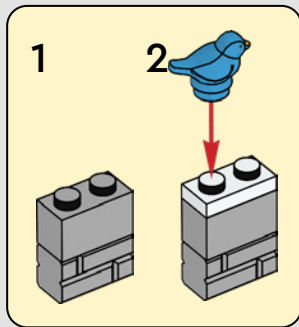

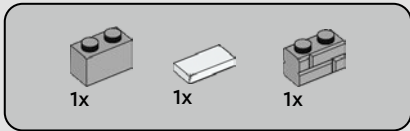

797

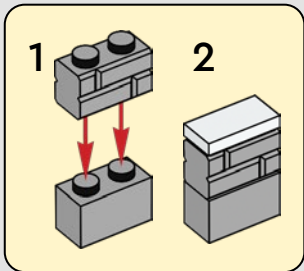

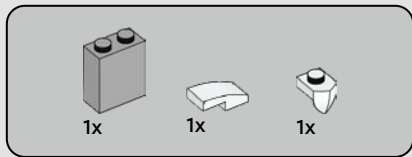

798

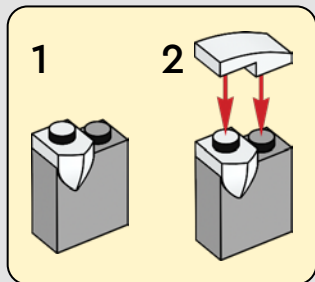



1x



1x



1x

799

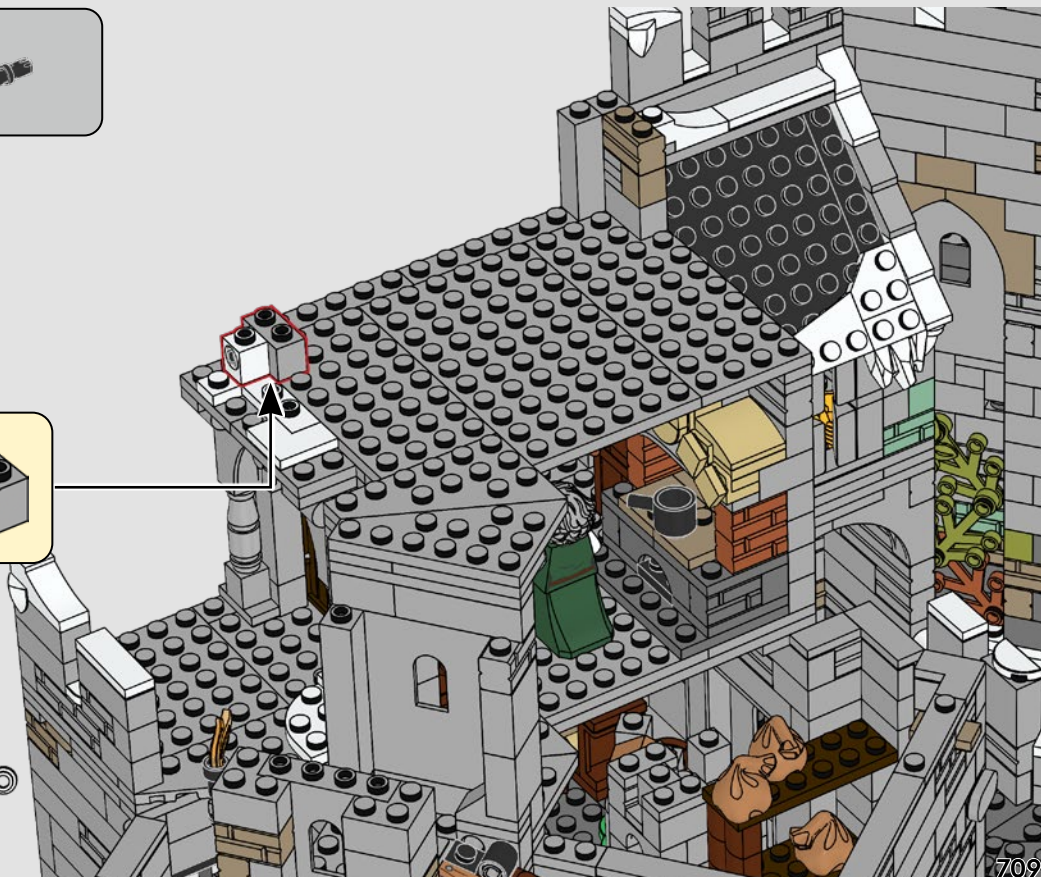
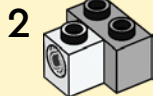
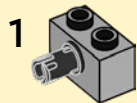

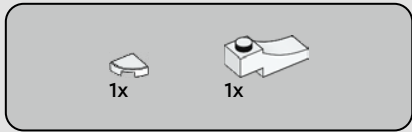

800

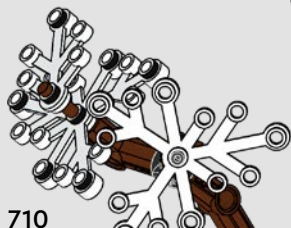
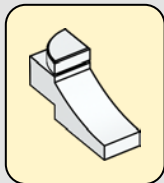



1x



1x

801

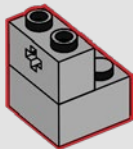

1x



1x

802

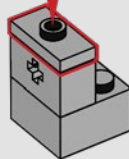

1x

803

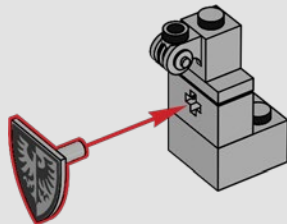

804

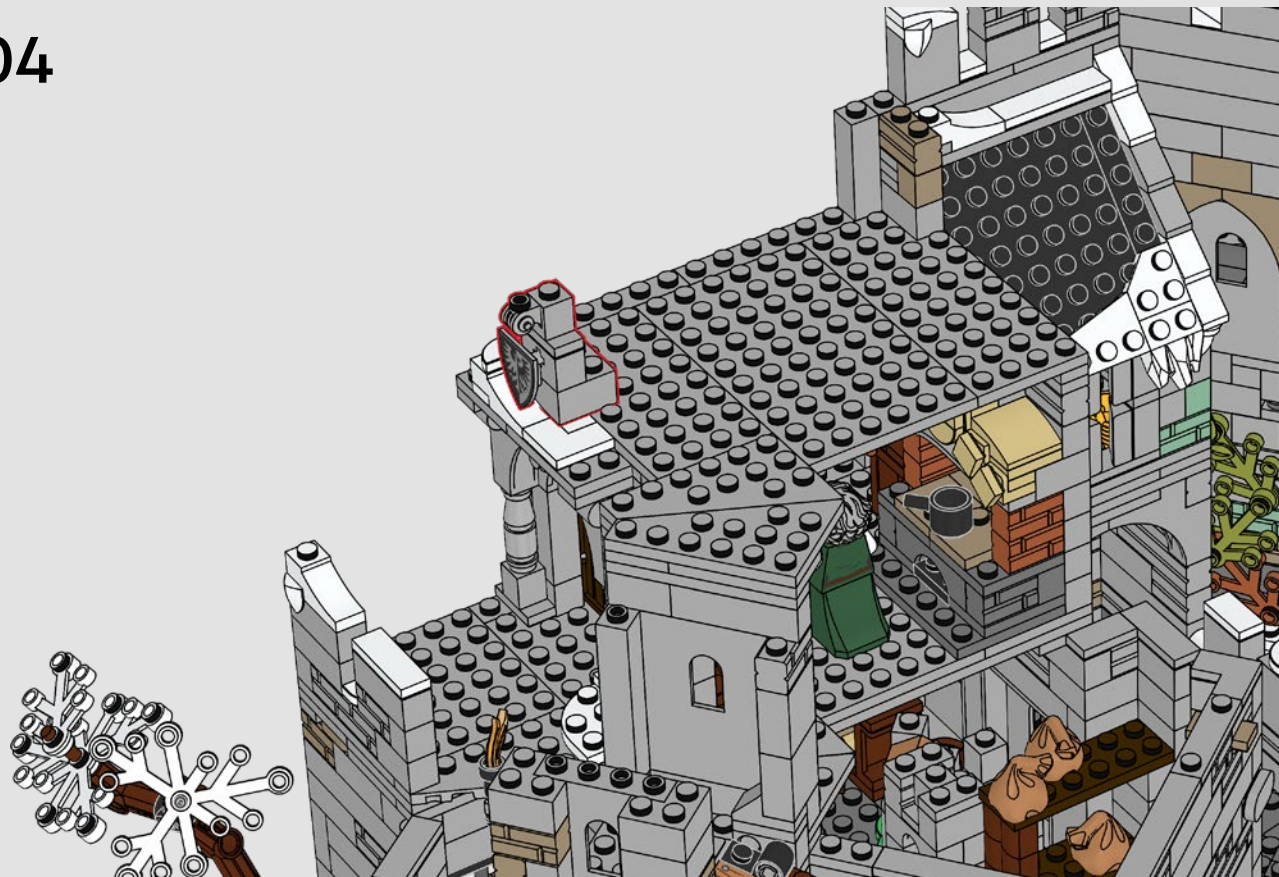

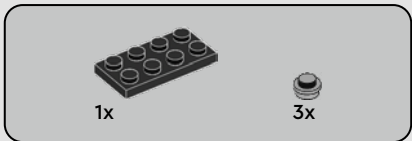

805

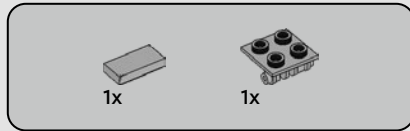
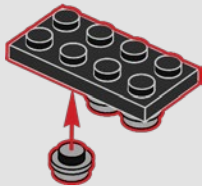

806

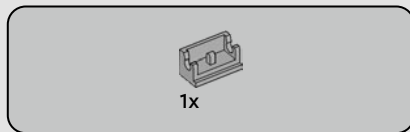
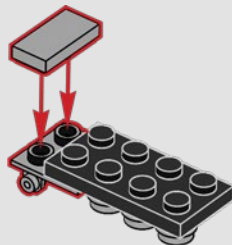

807

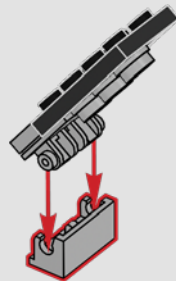

808



71406

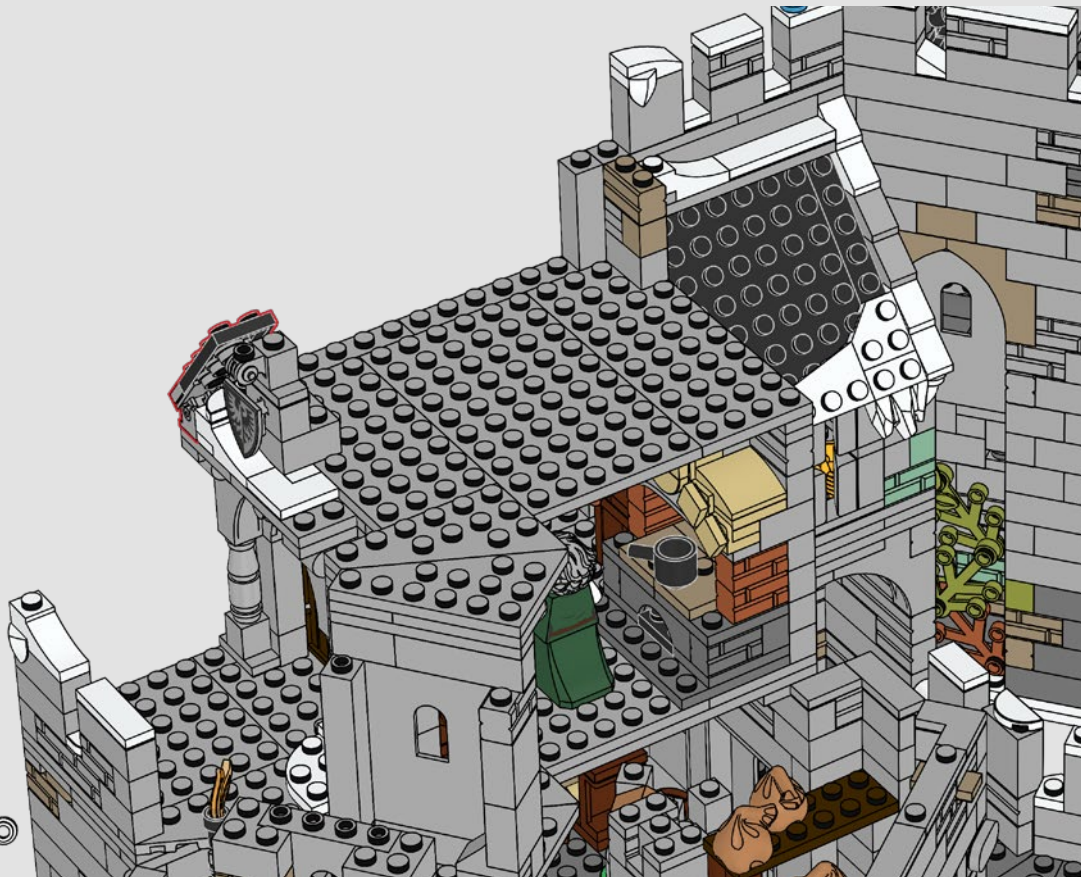

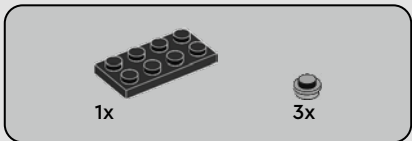

809

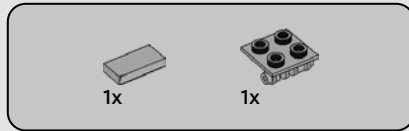
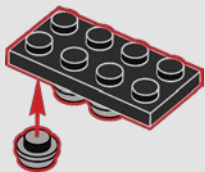

810

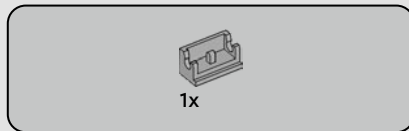
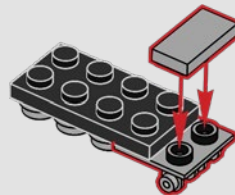

811

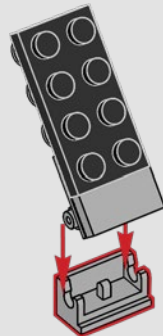

812

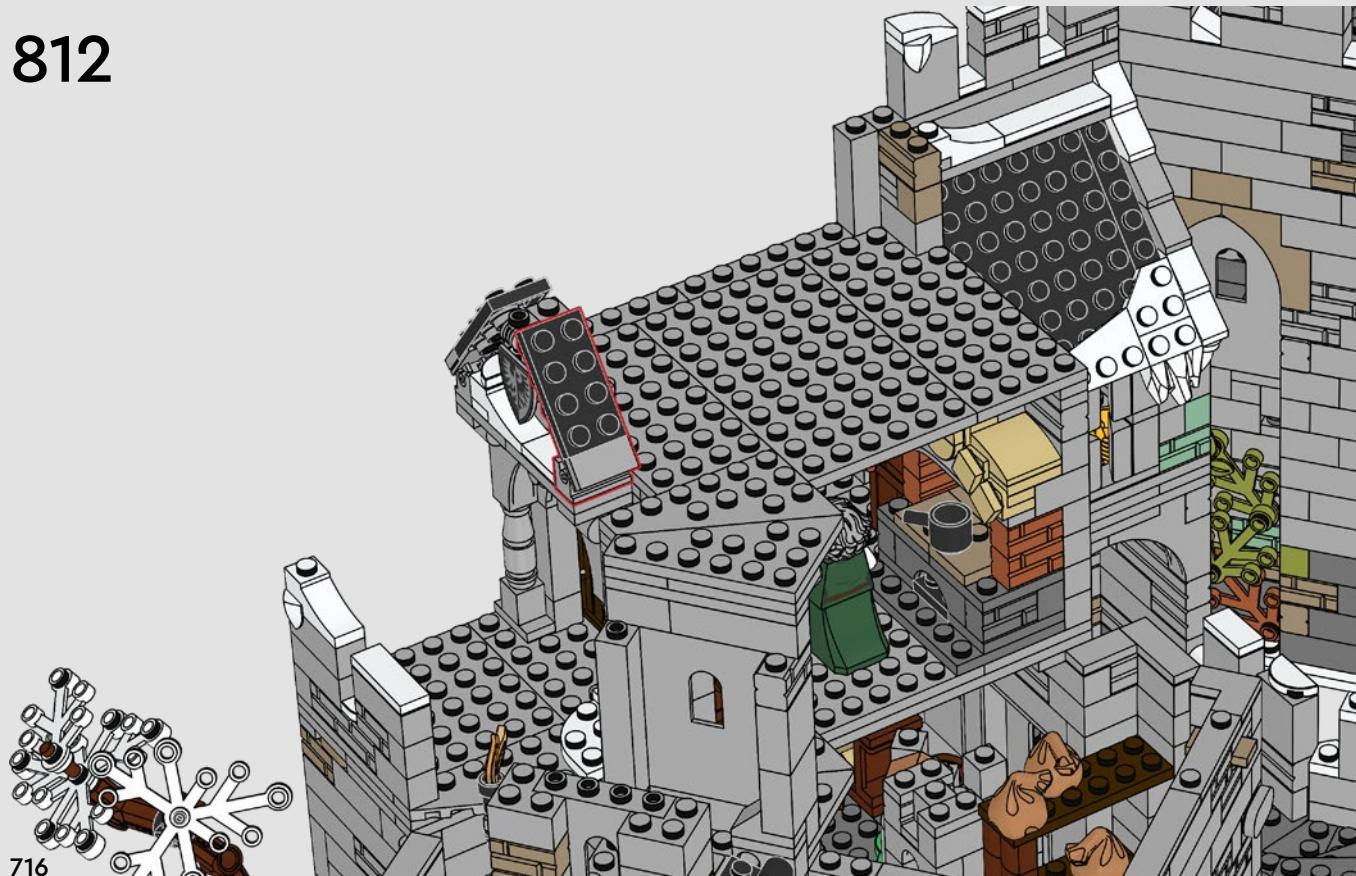

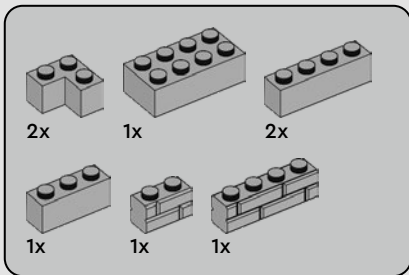

813



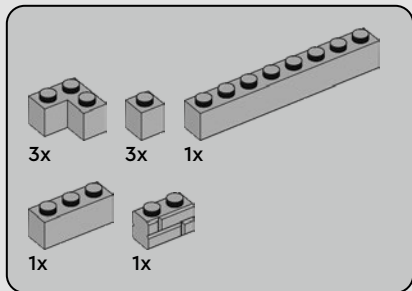

814



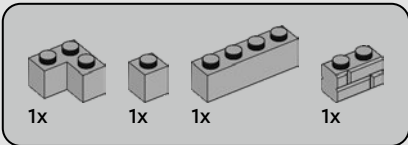

815



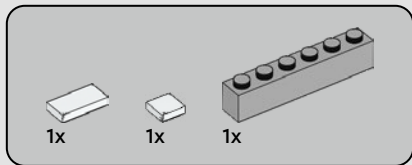

816



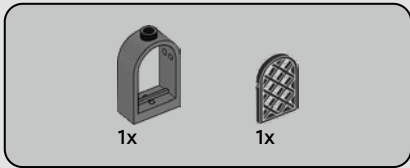

817





2x



2x

818



2x



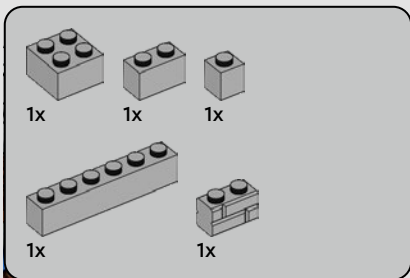

814

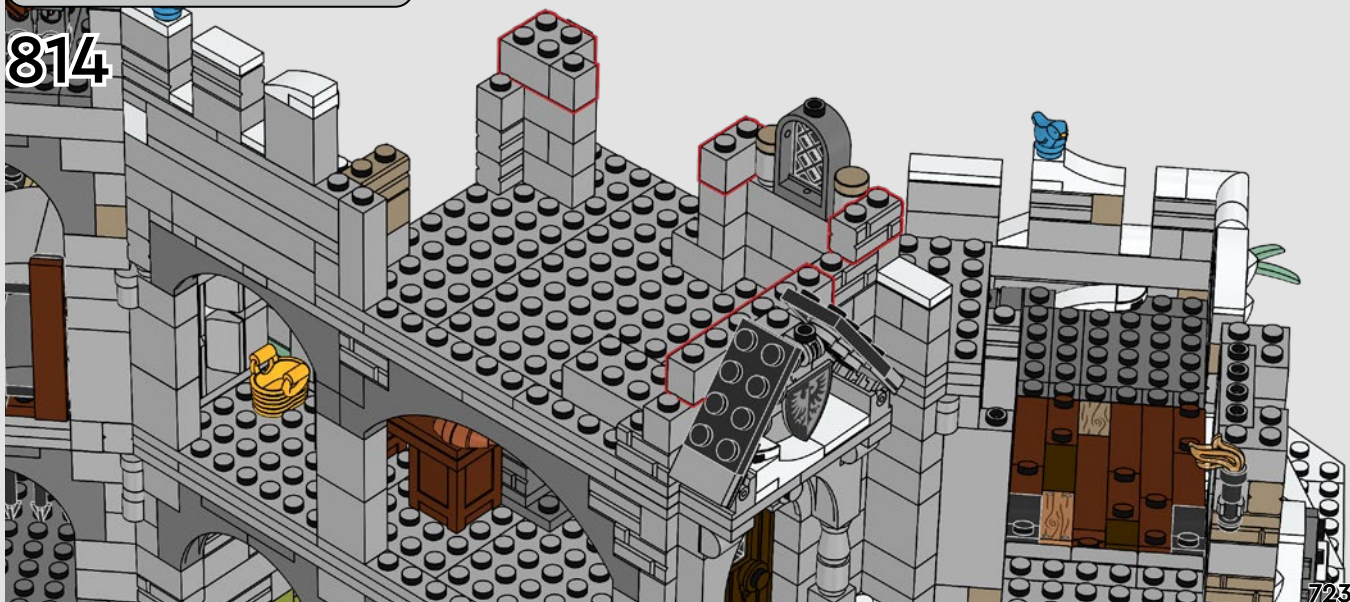



1x



1x



1x

815



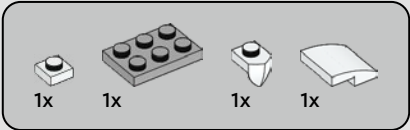

821

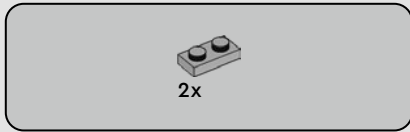
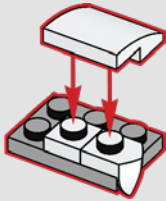

822

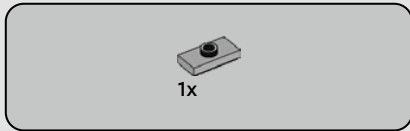
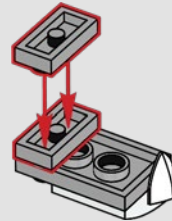

823

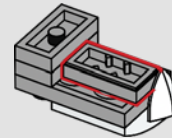

819





1x



1x

820





1x



2x

821





822

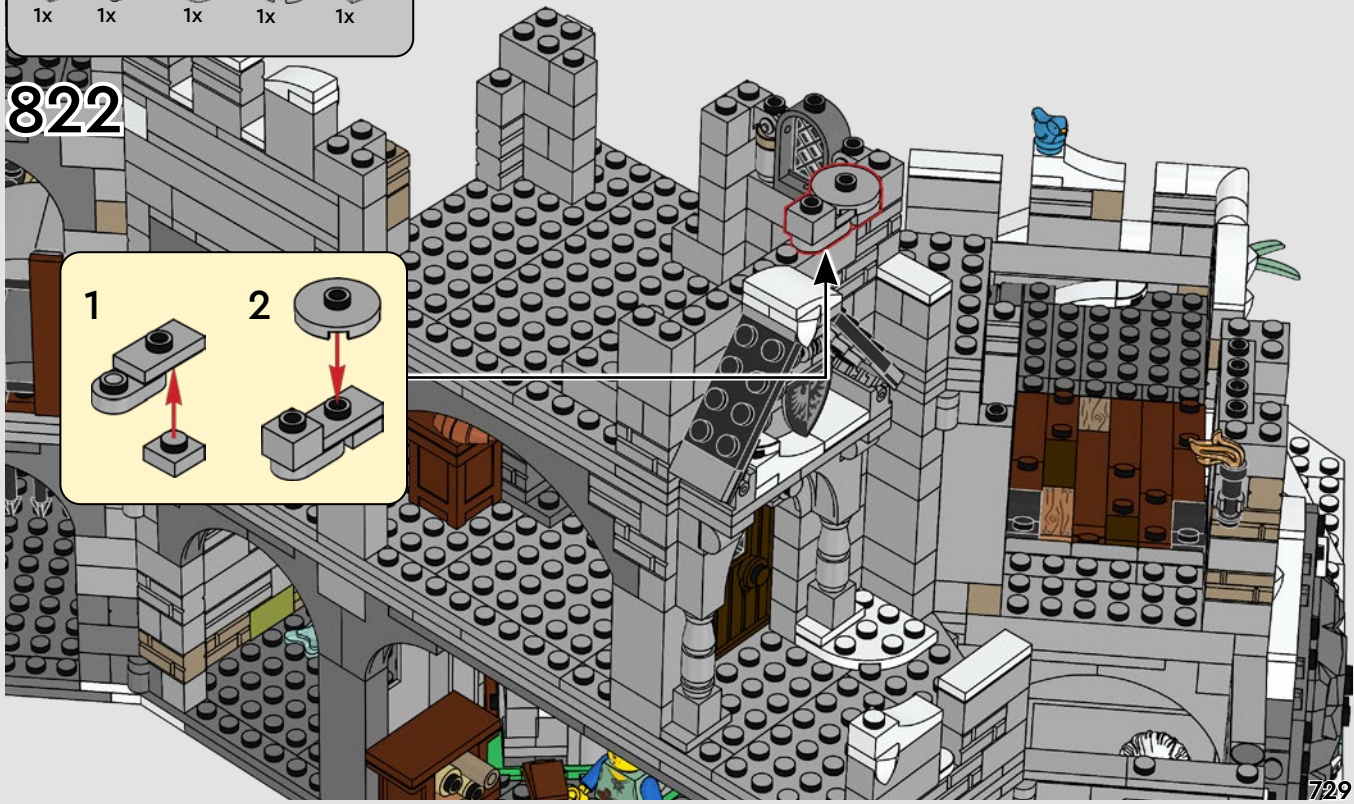
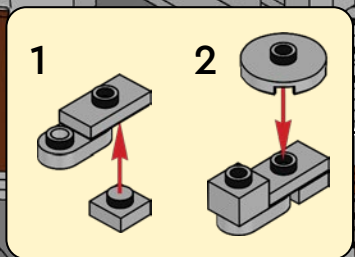

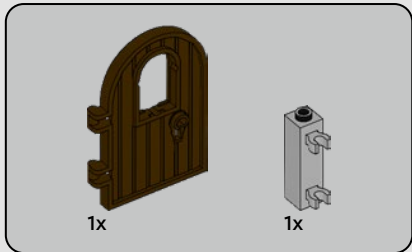
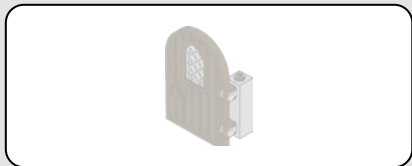

828

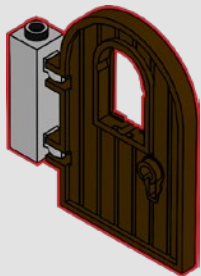

829

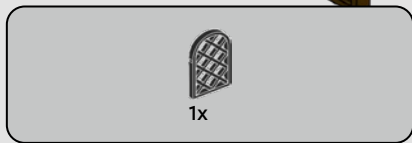
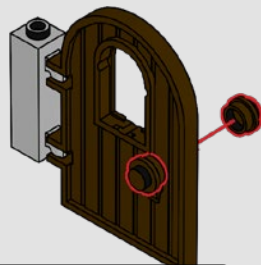

830

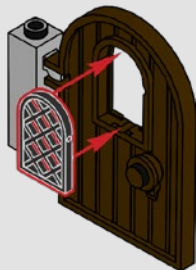

826



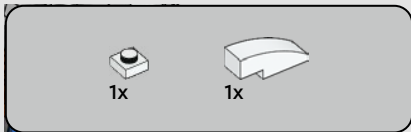

827

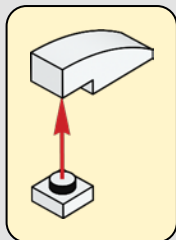

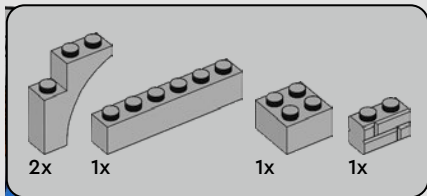

828



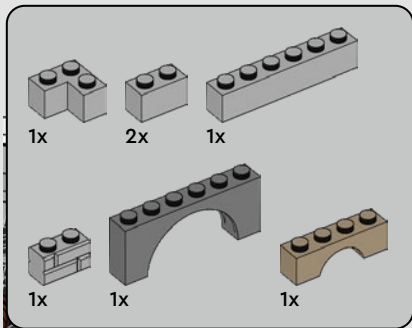

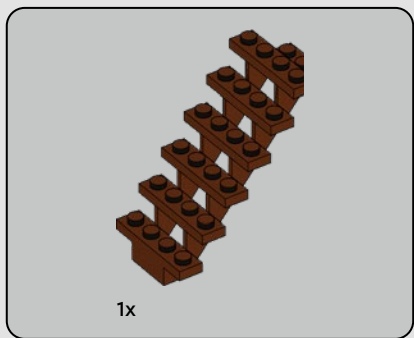
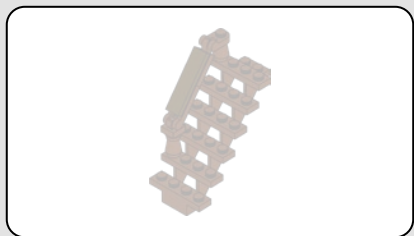

835

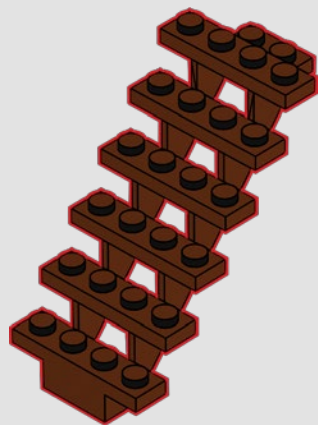



1x



1x



836

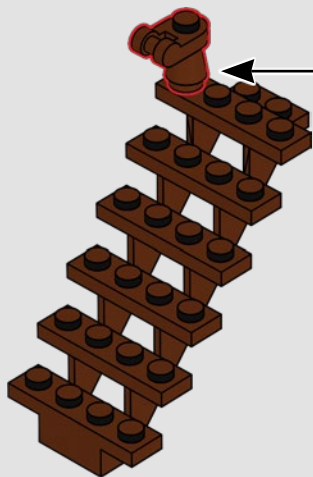

1x



1x



1x

837

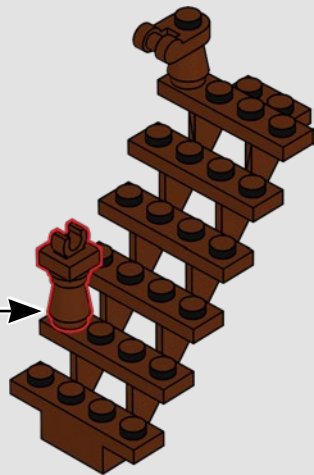

1



2



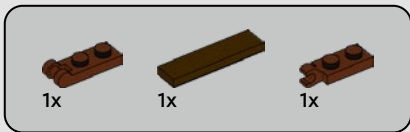

838

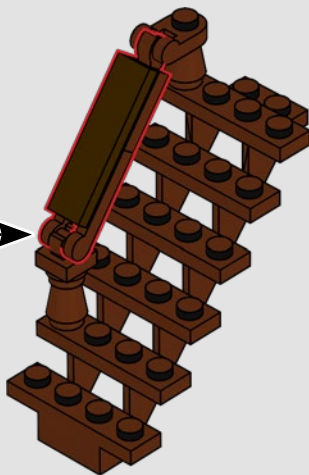
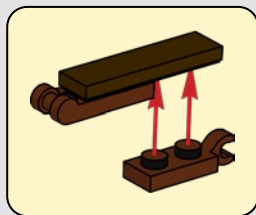

834



738

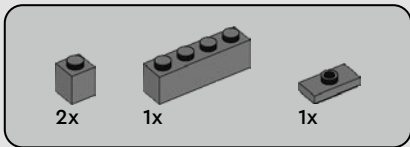

840

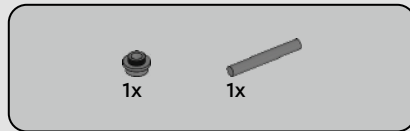
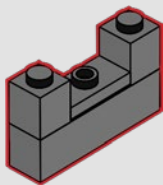

841

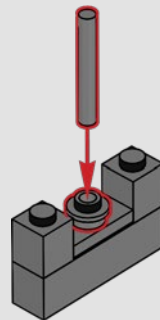



1x



1x

842

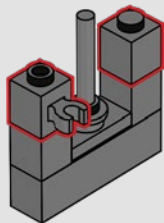

2x

843

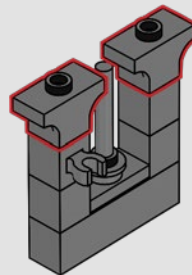



844

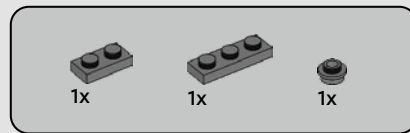
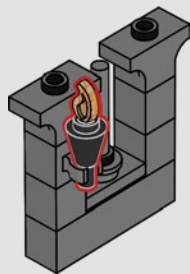

845

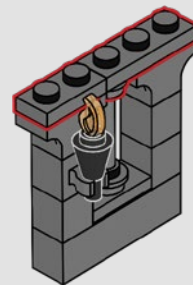
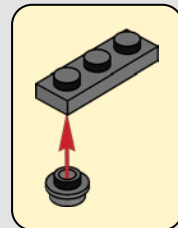

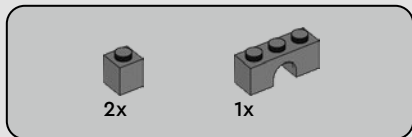

846

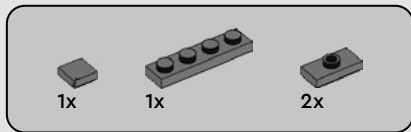
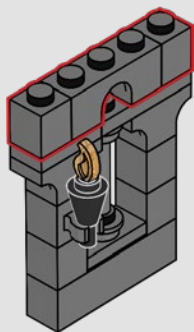

847

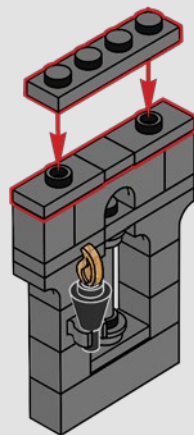

843



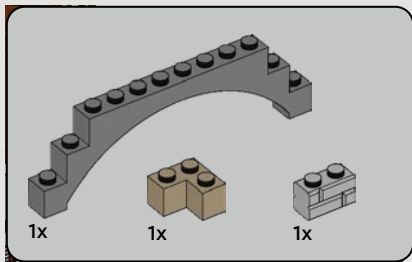

844

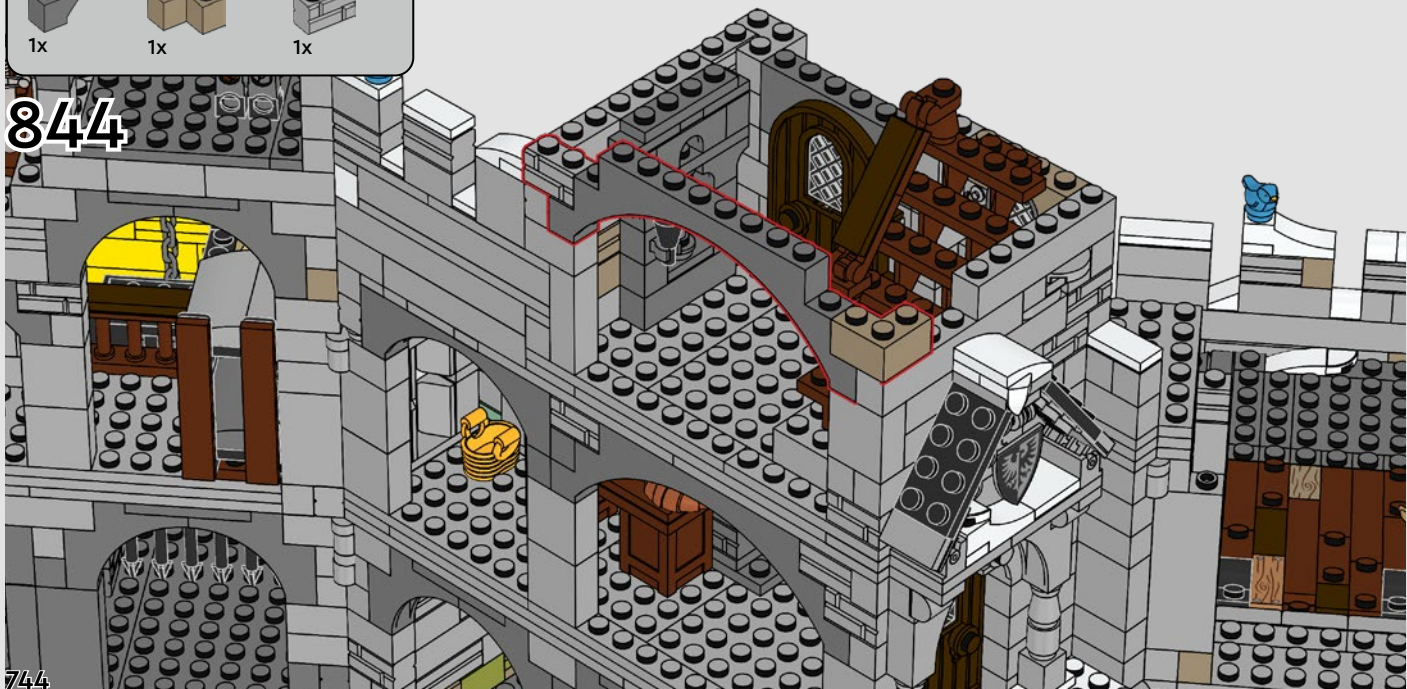



845

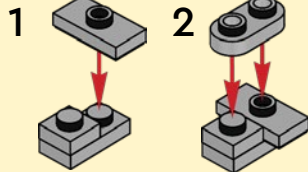



2x



1x



1x

851



2x

852





1x



1x

853

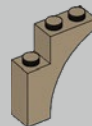

1x

854

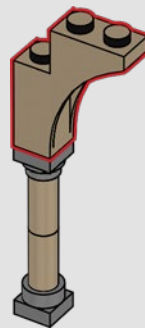

2x
747

855



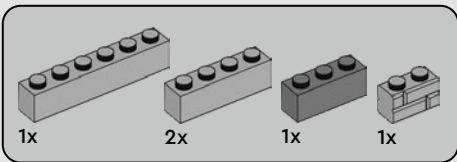

856





1x



1x

857

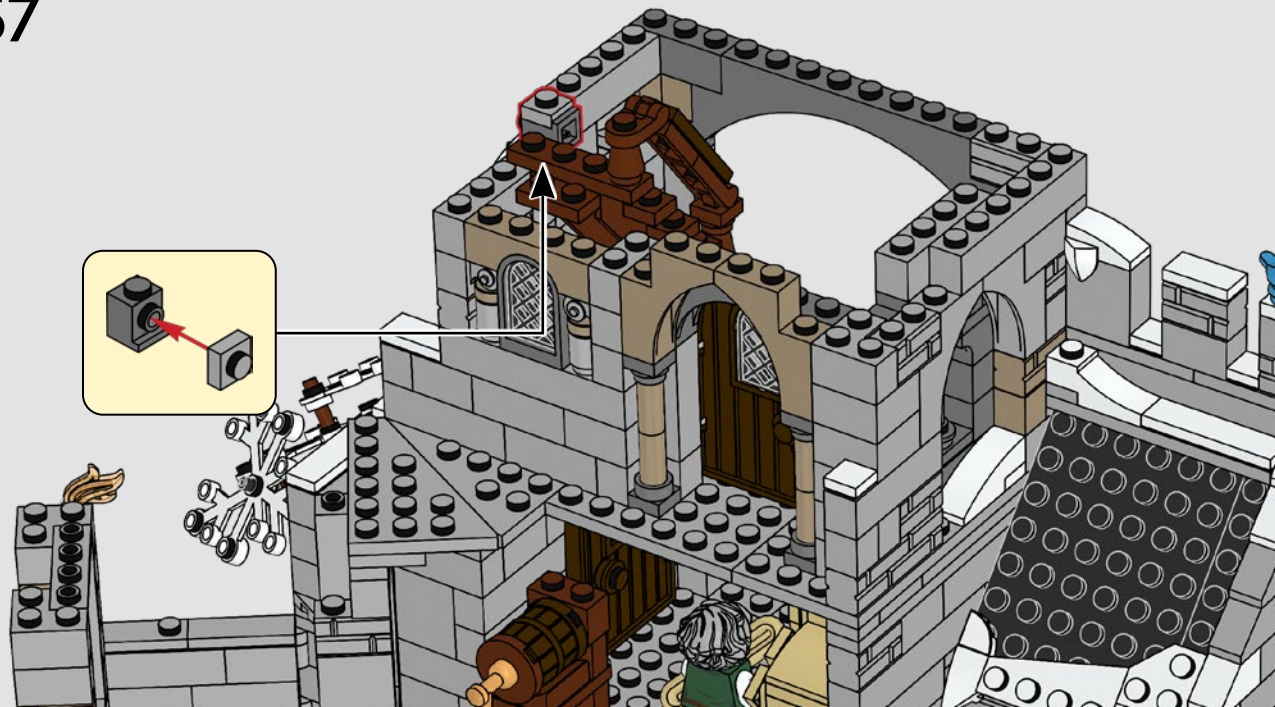



1x



1x



1x

858

1 2

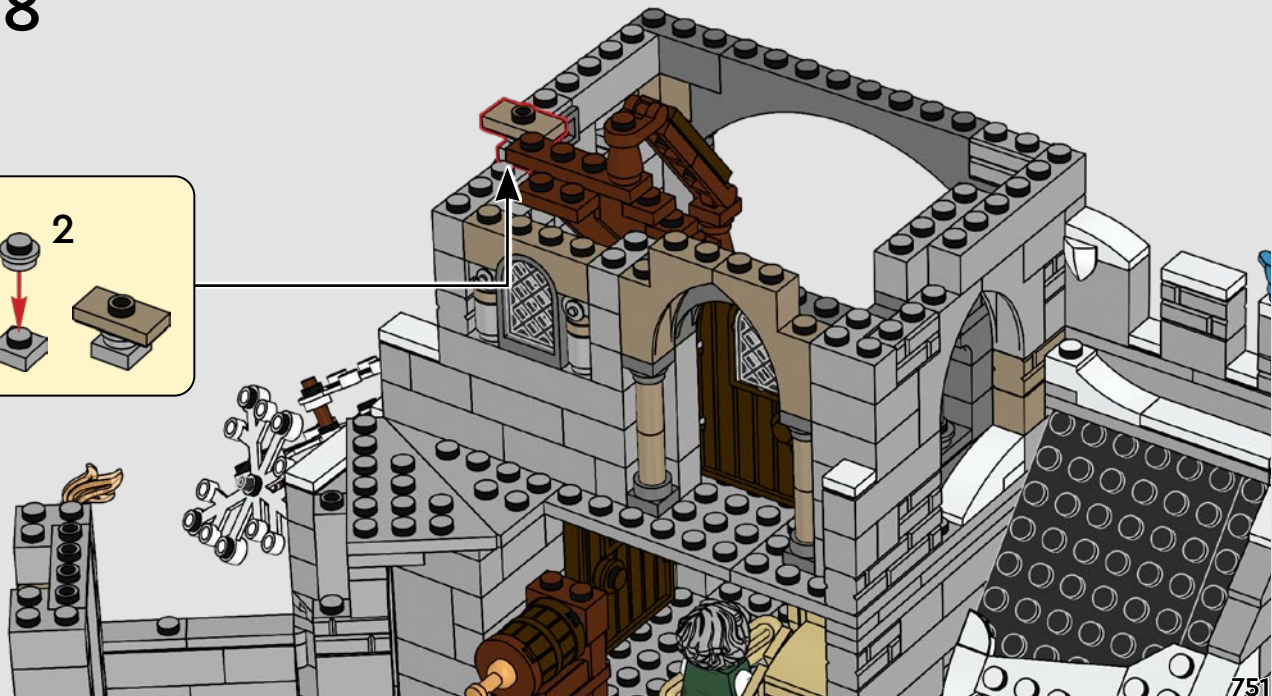

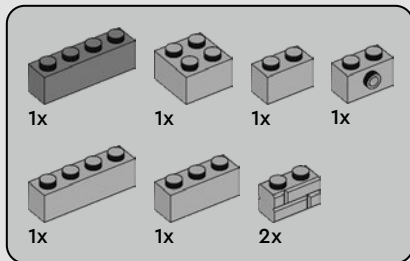

859

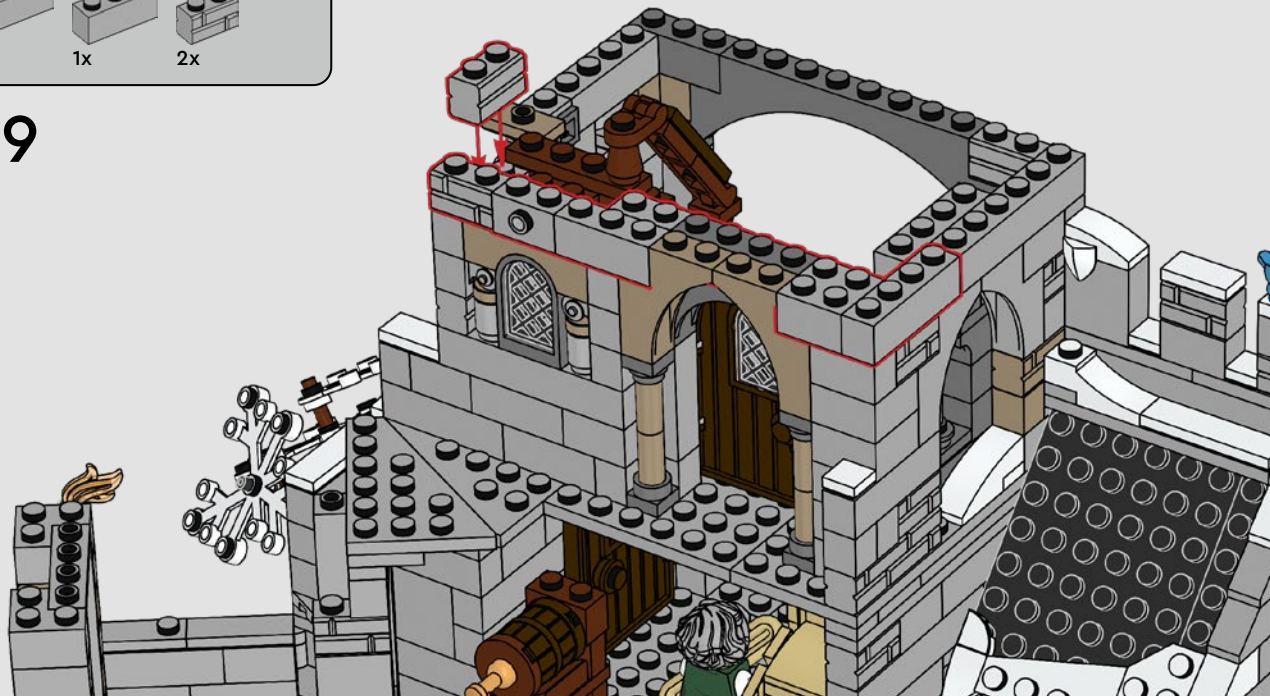

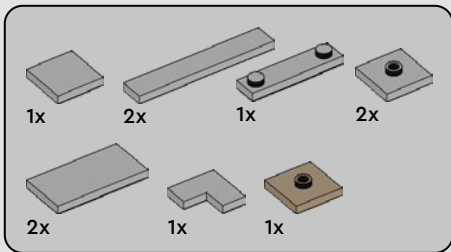

860

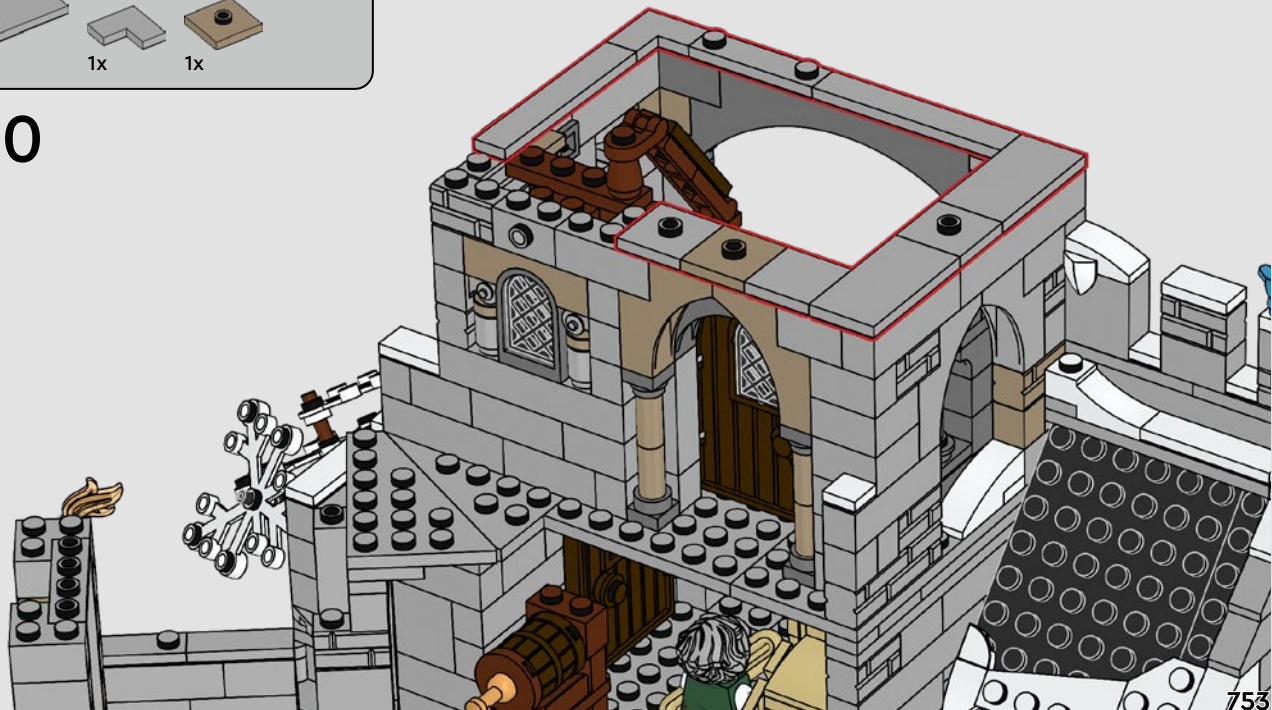

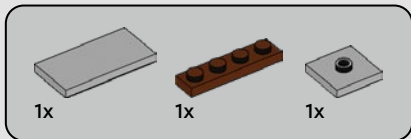

861

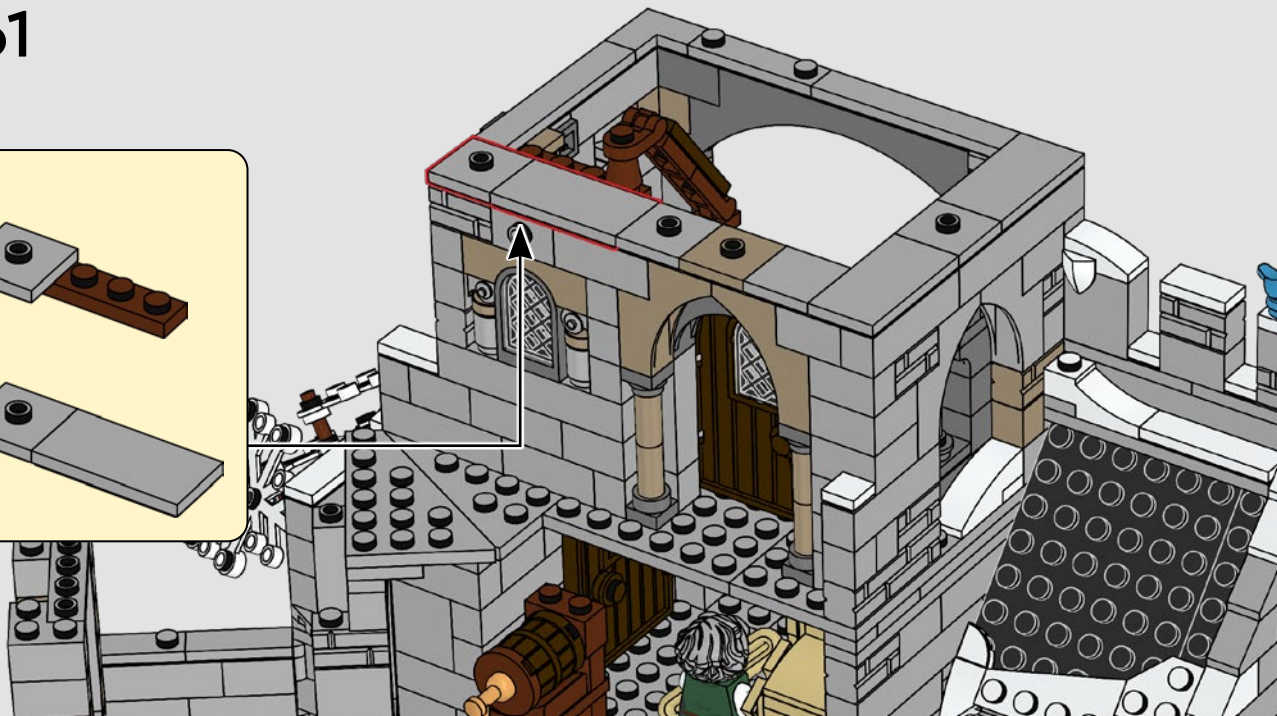
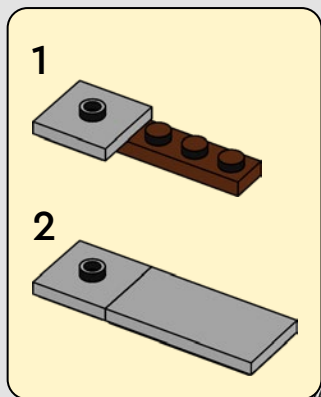



1x



1x



1x

862

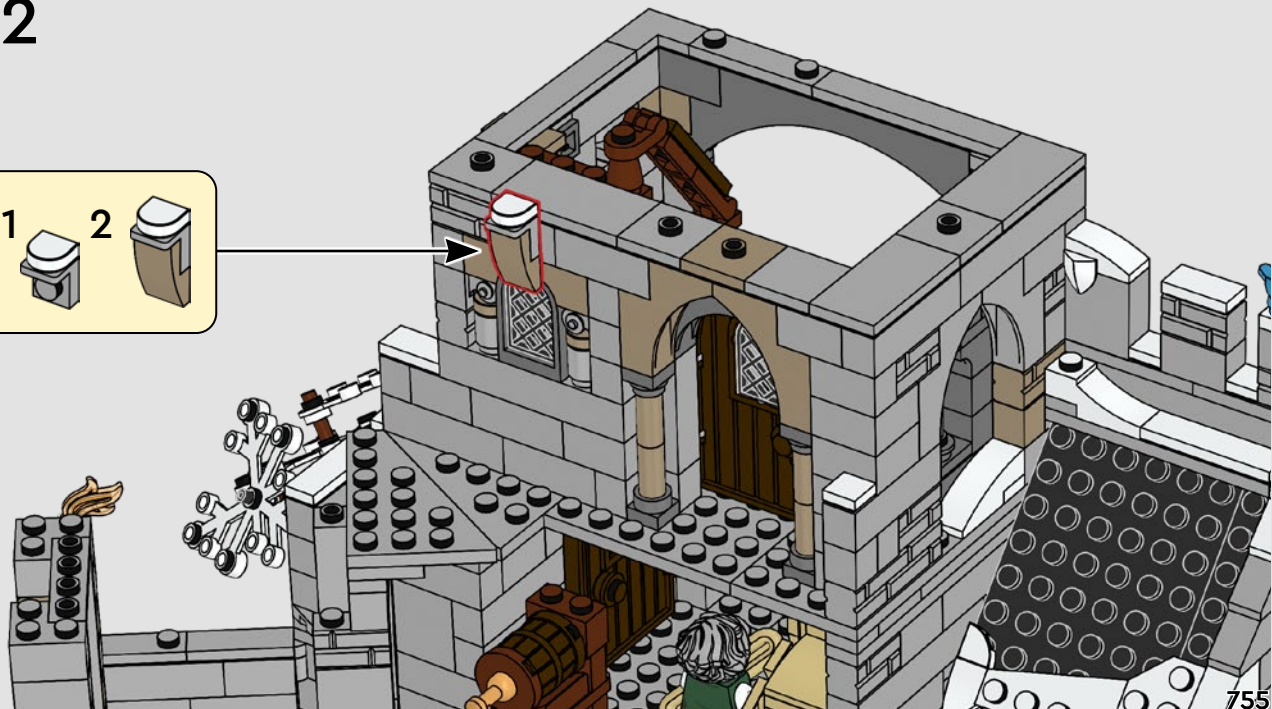
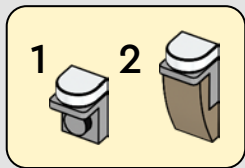

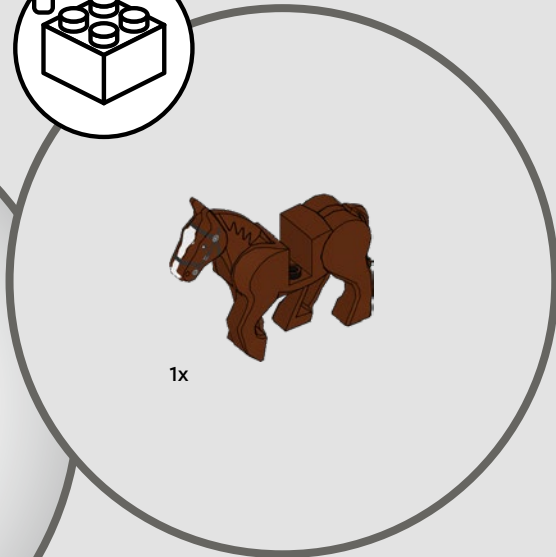
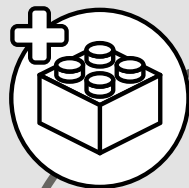

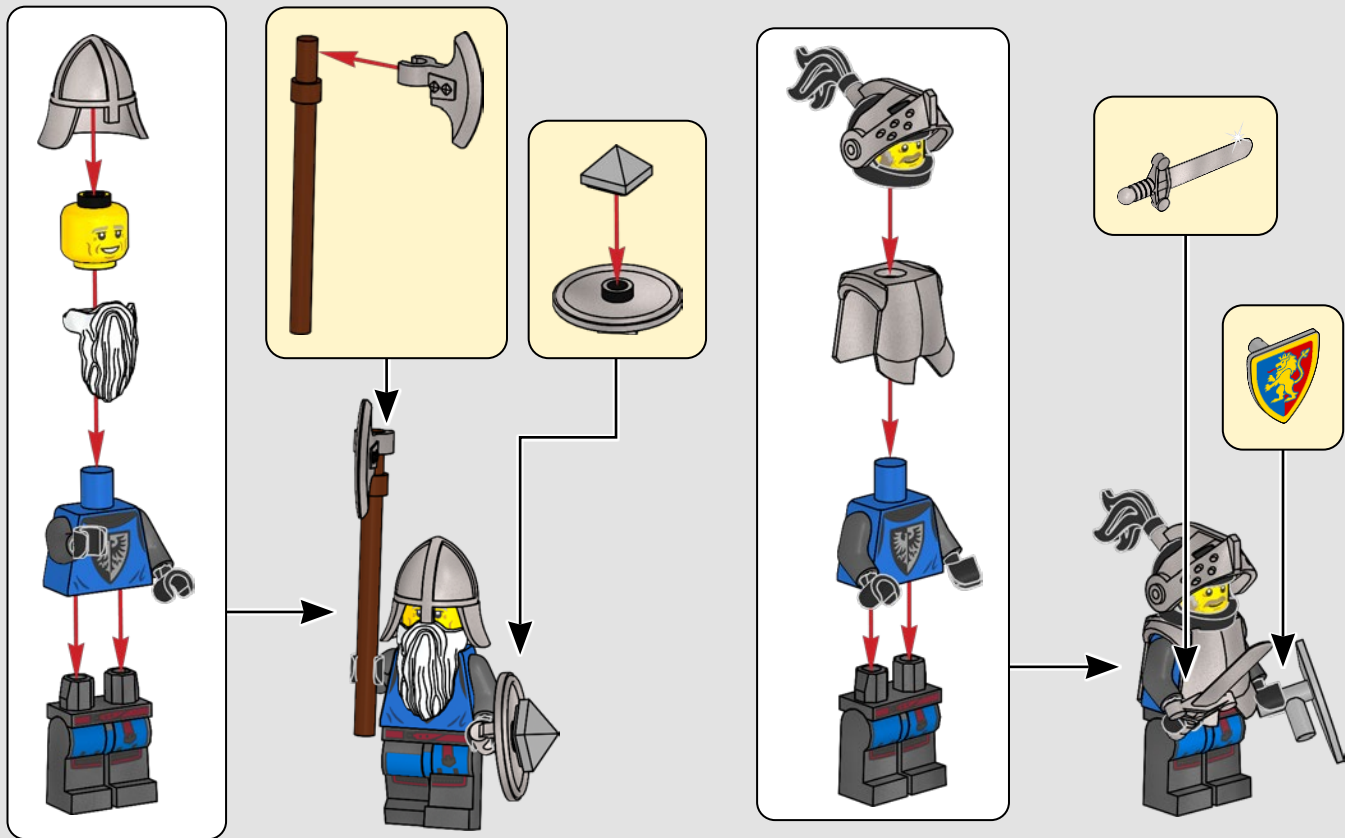

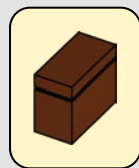
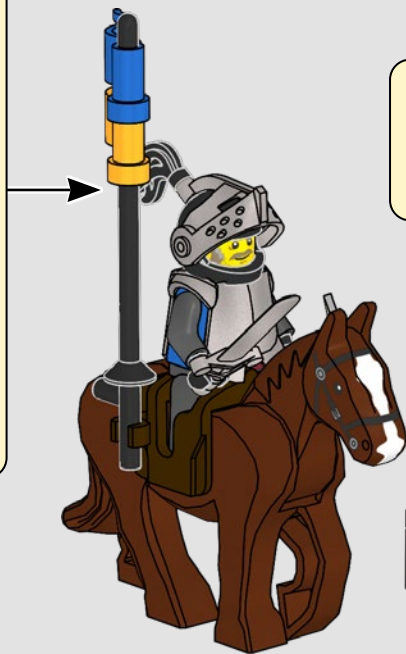
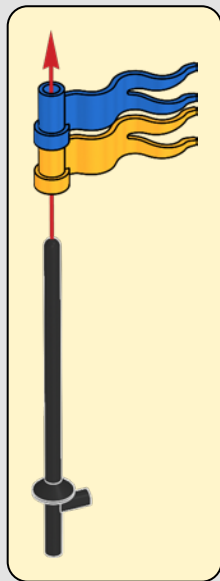
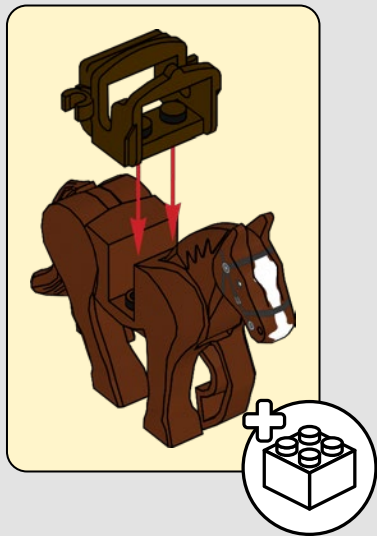

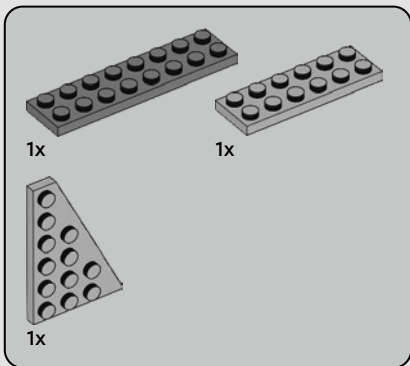
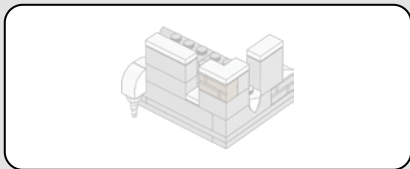

863

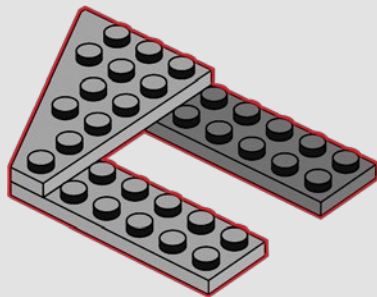

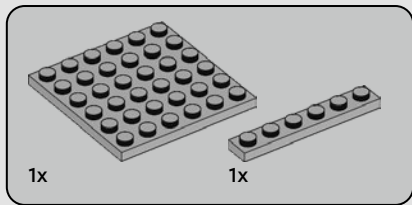

864

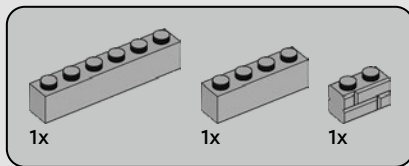
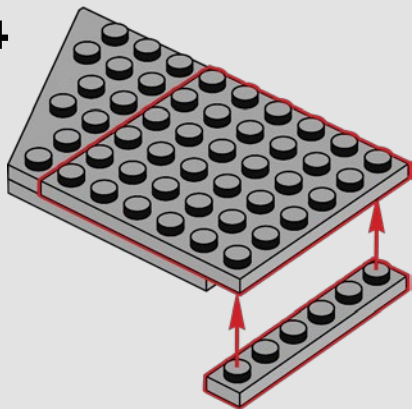

865

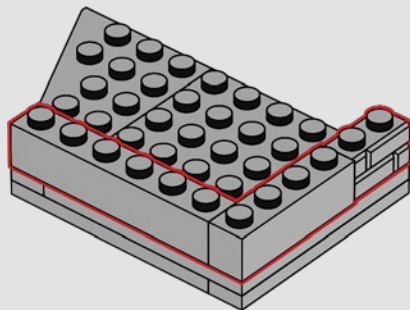



1x



1x



1x

866

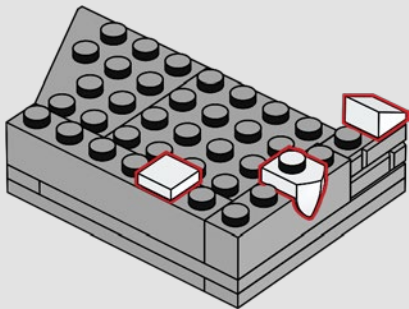

1x



1x

867

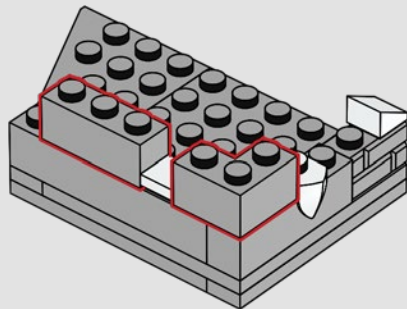

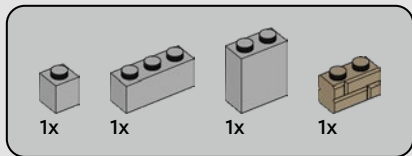

868

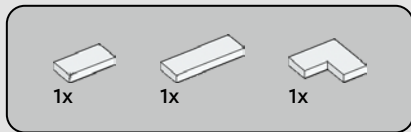
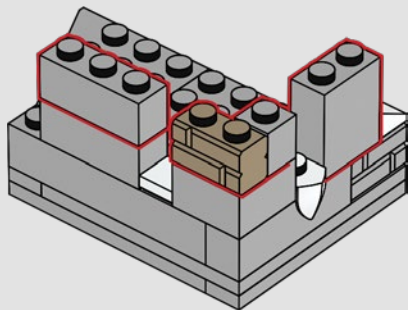

869

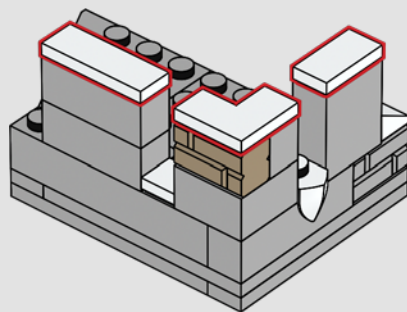

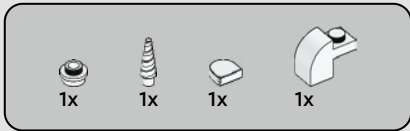

870

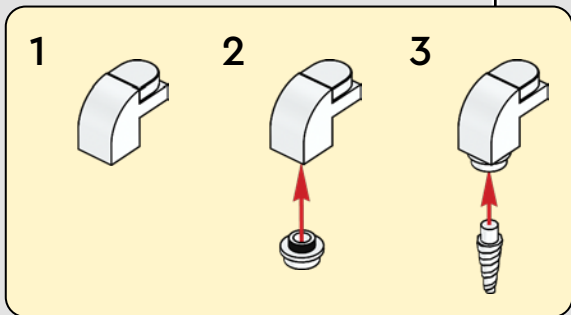
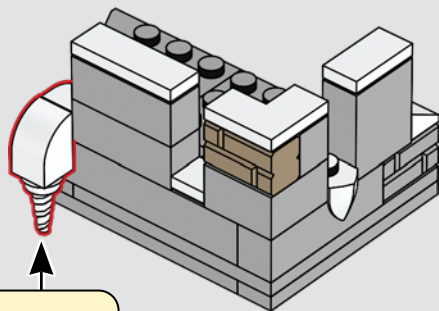

866



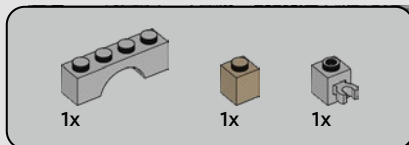

872



1x  1x 

868

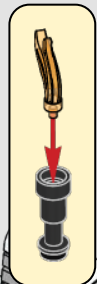



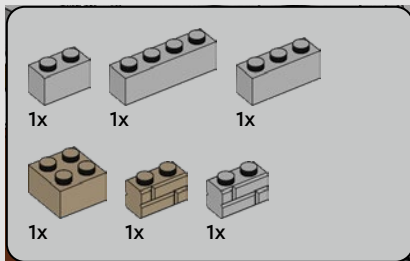

870

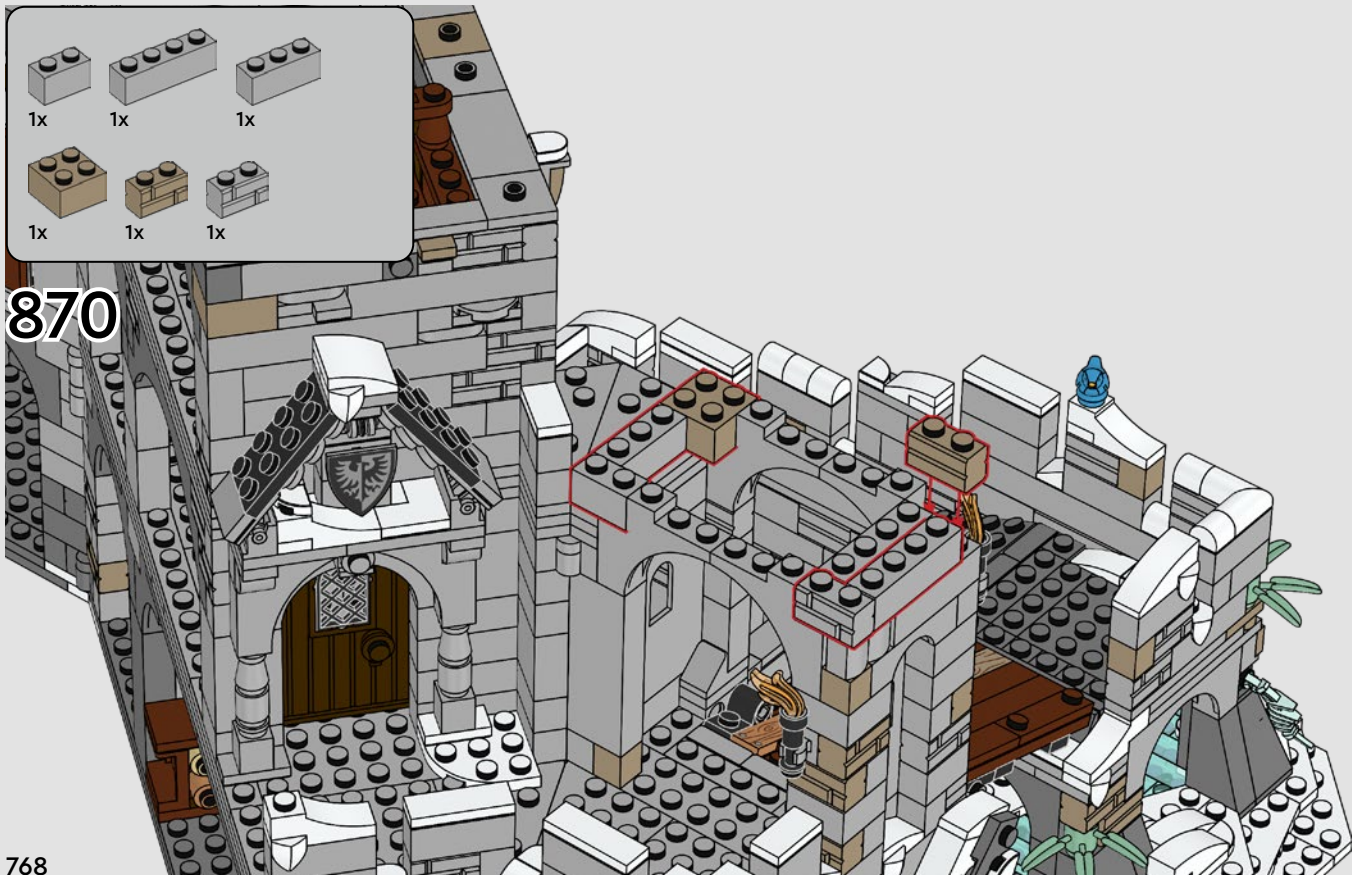

1x

2x

871



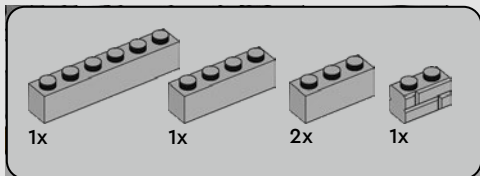

872





1x



1x

873

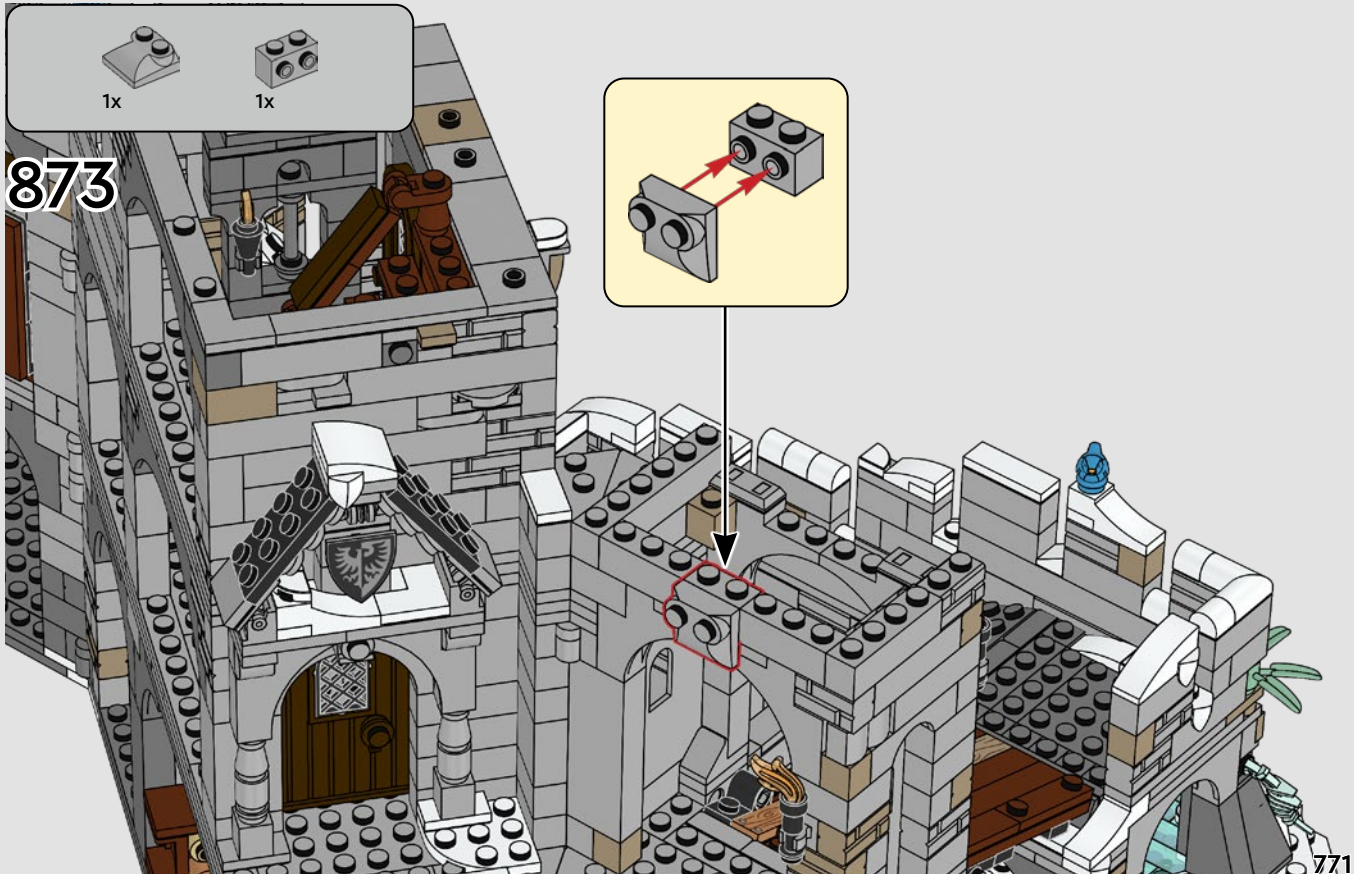
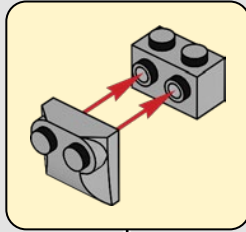

1x 2x 1x

874

1 2



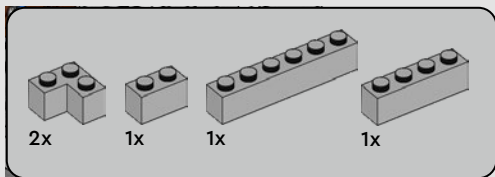

875

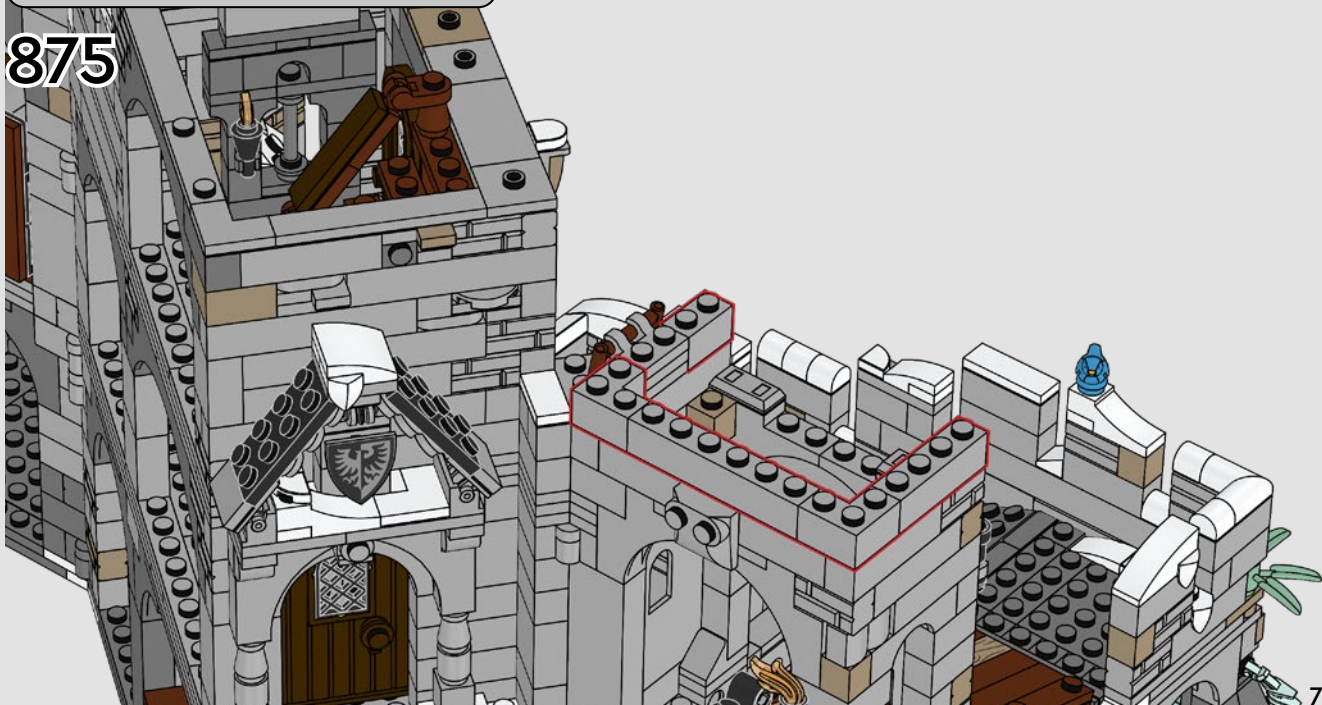

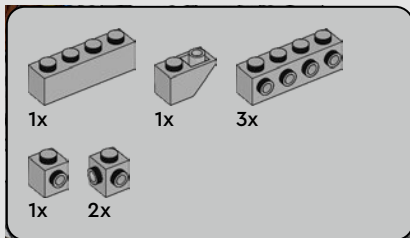

876

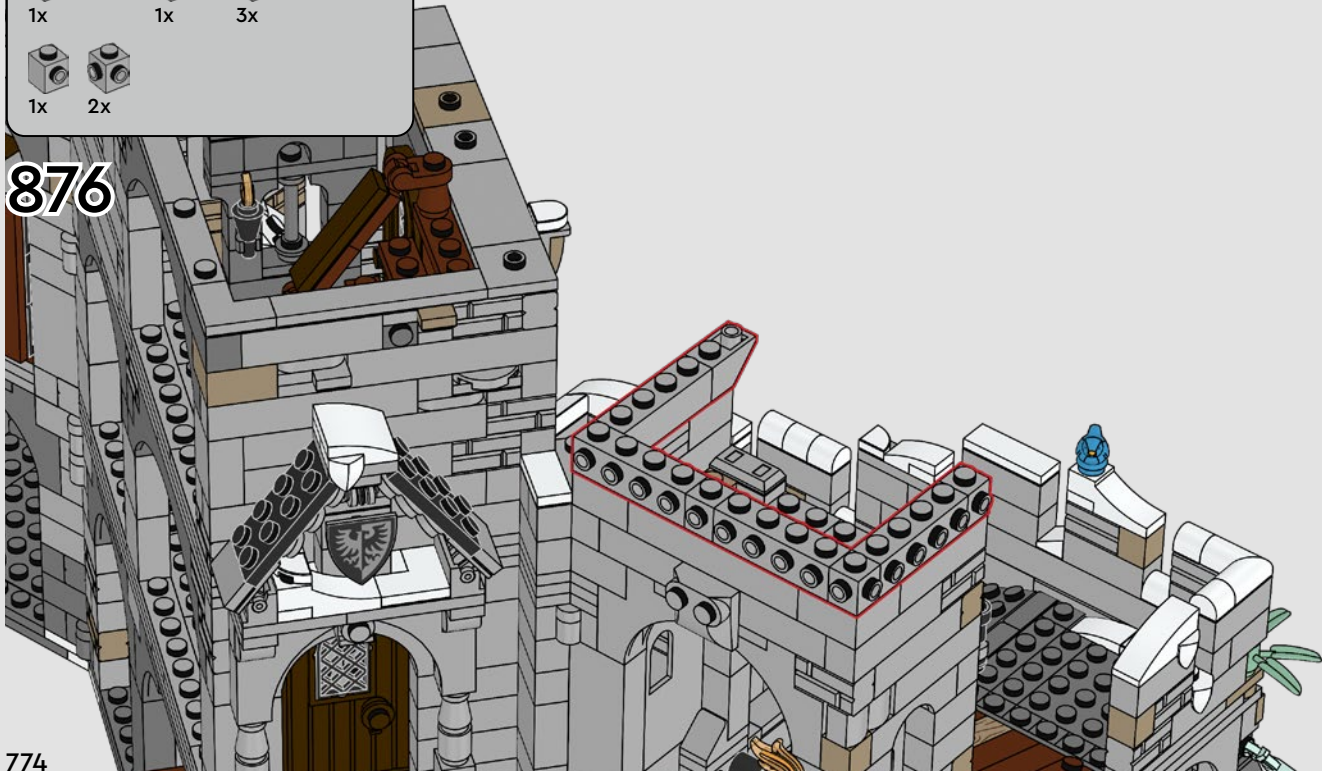

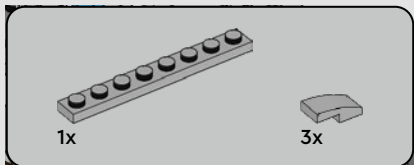

877

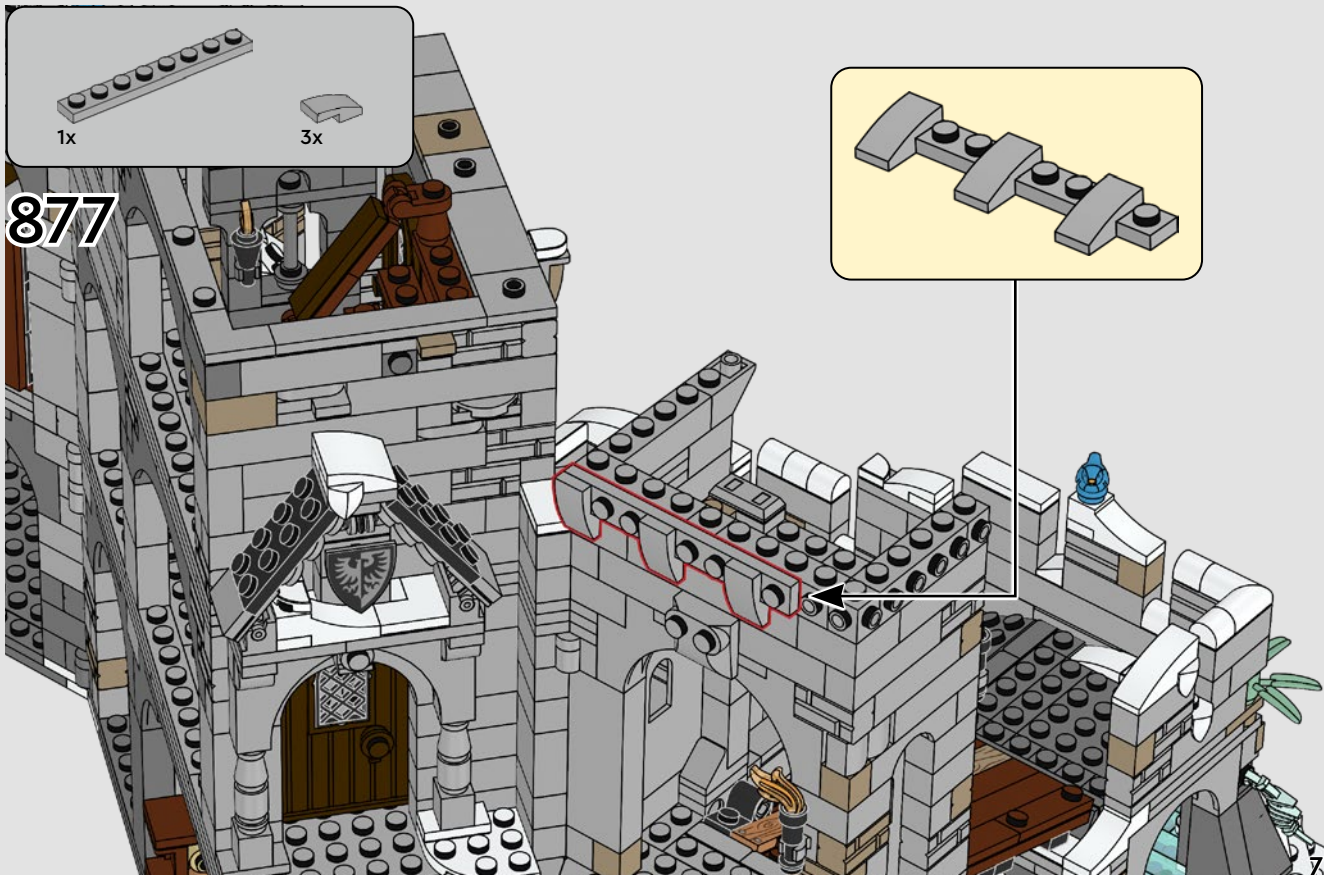
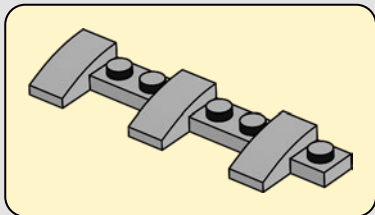

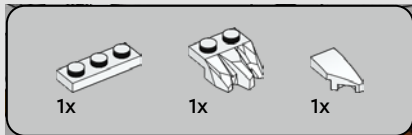

878

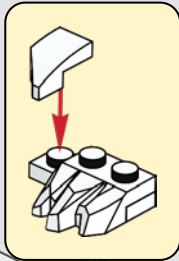

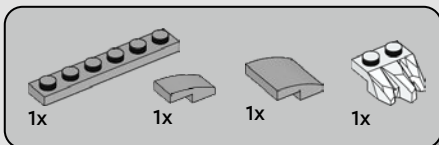

884

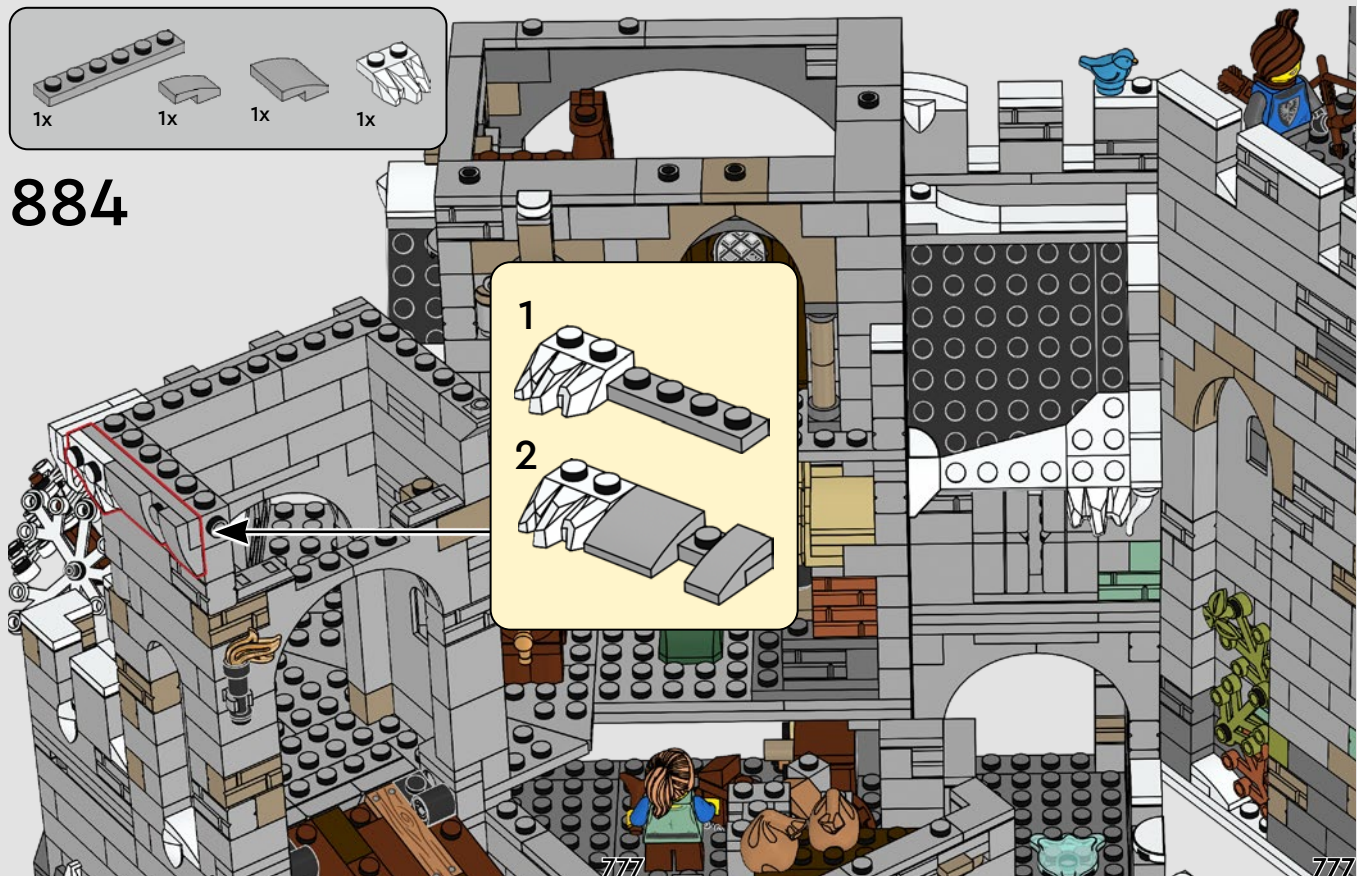
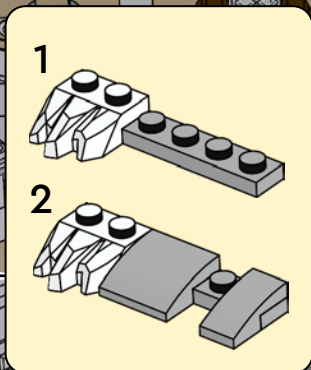



1x



1x

885

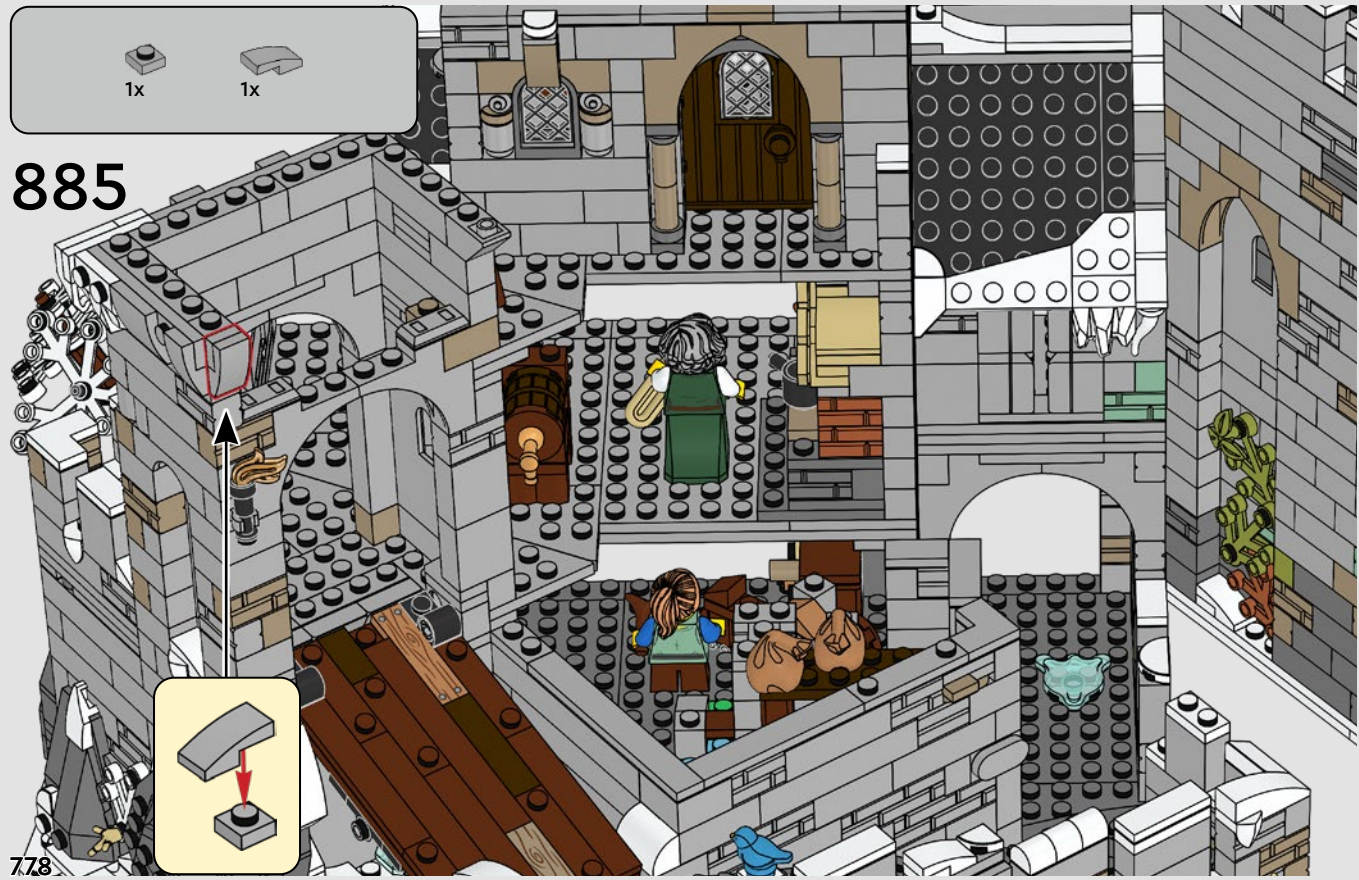

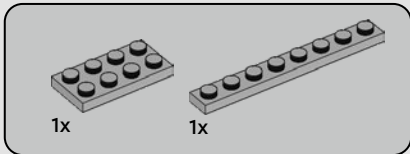
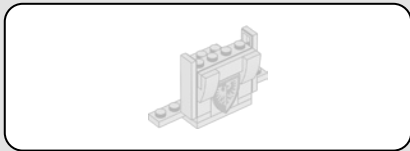

886

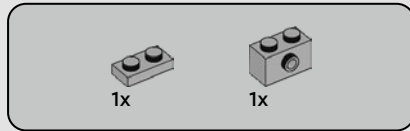
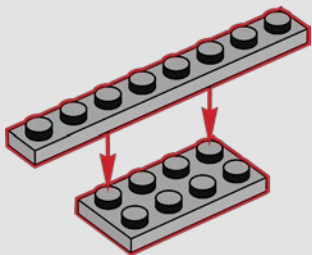

887

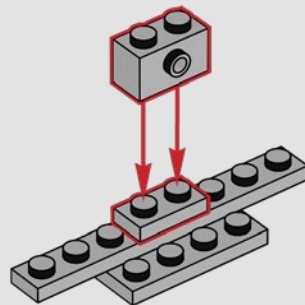

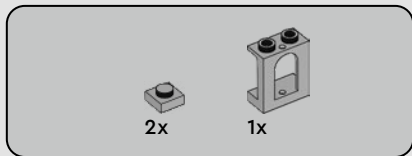

888

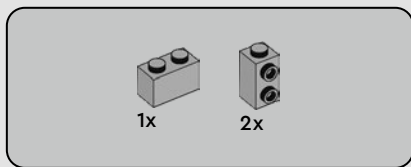
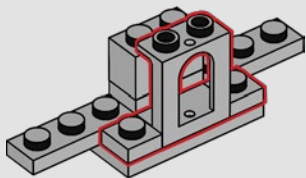

889

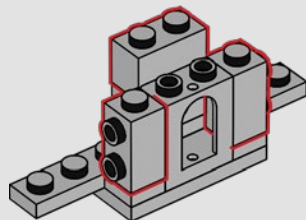

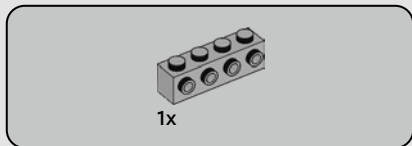

890

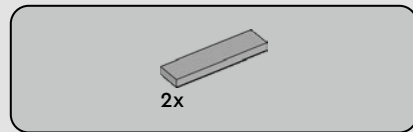
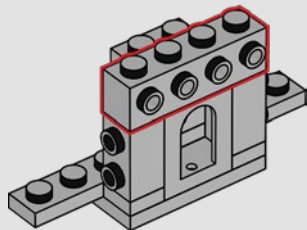

891

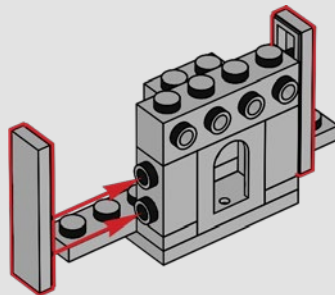

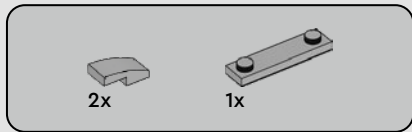

892

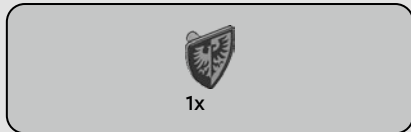
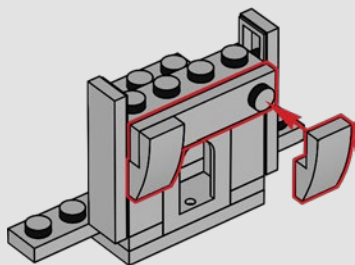

893

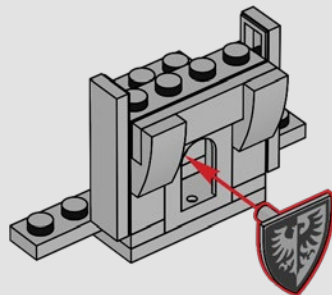

894



783

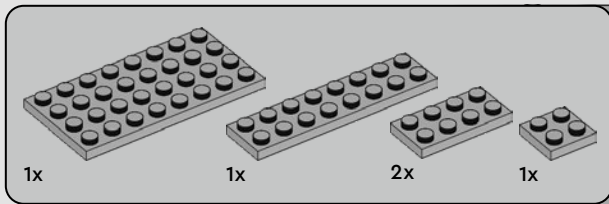

895

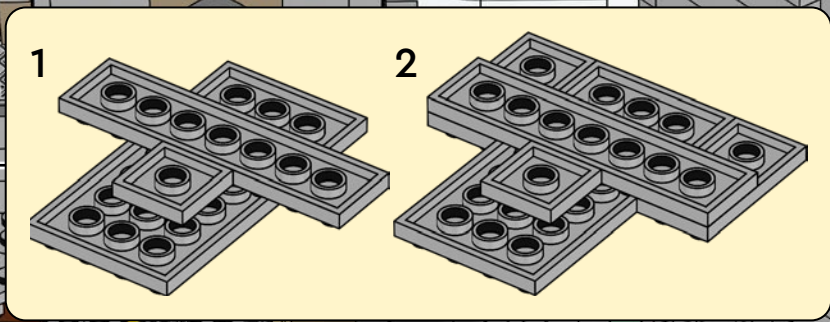

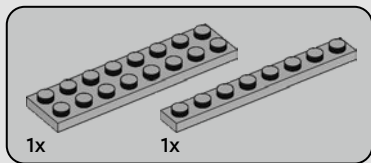

896



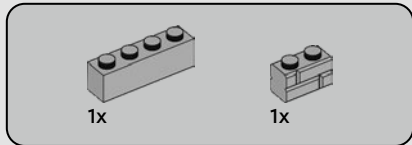

897



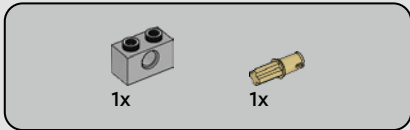
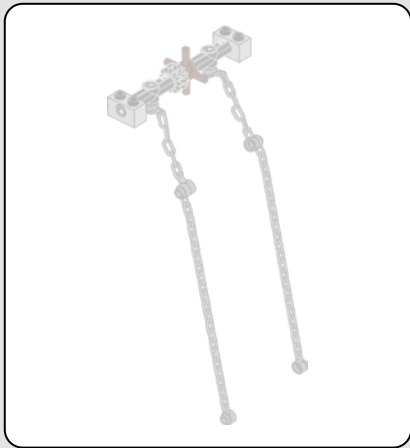

898

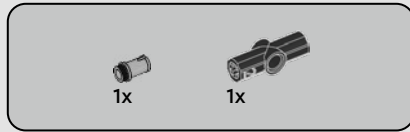
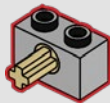

899

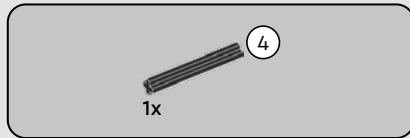
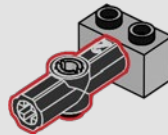

900

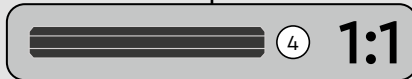
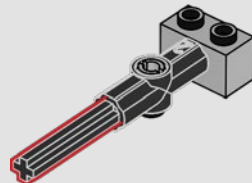



1x



1x

901

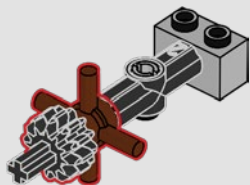

1x



1x

902

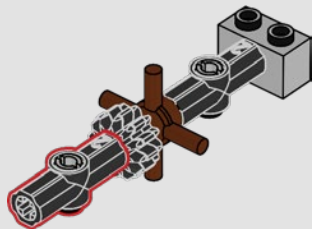

1x



1x

903

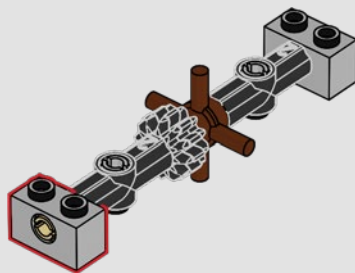

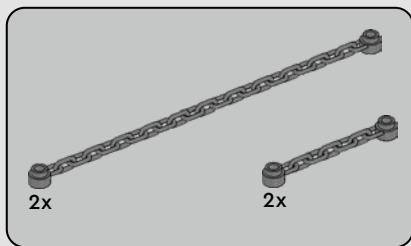

904

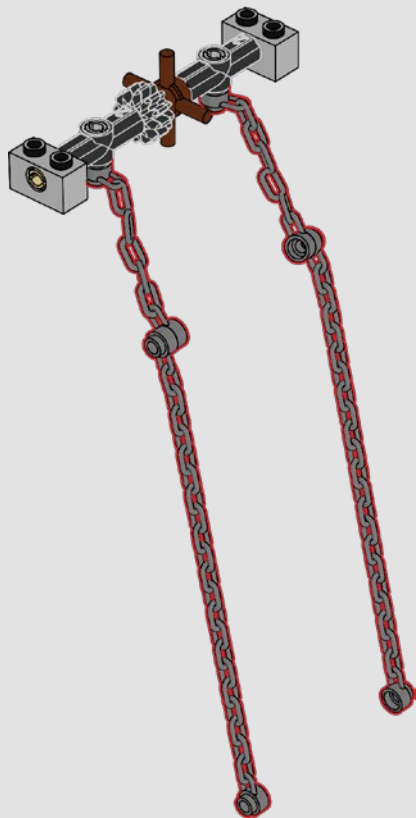

905



790

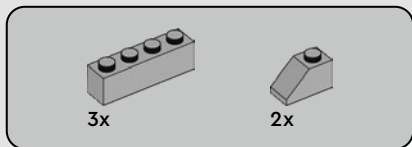

906



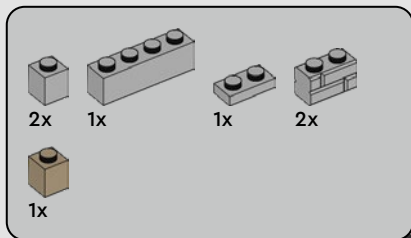

908



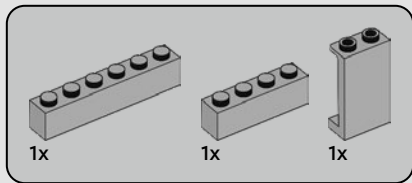

909

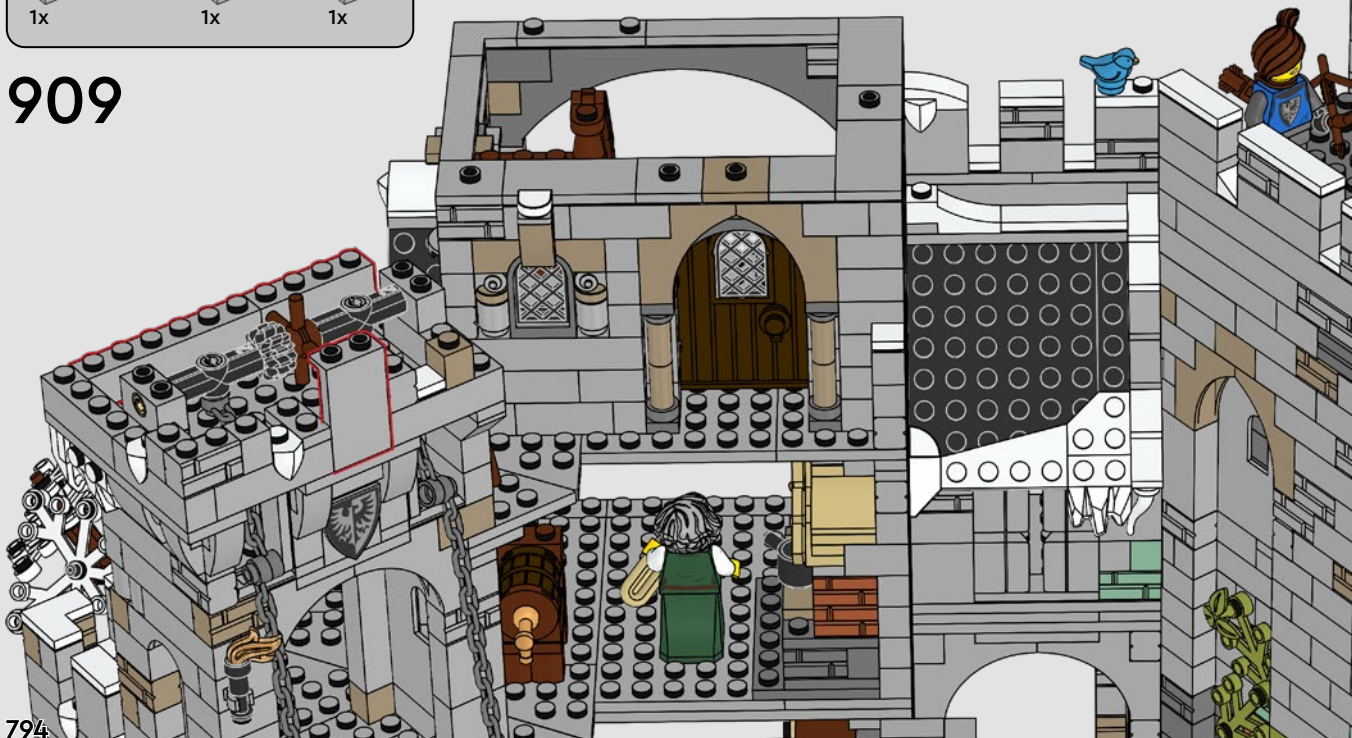

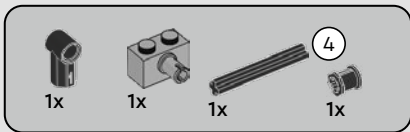

910

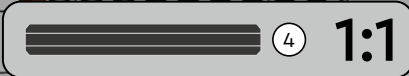
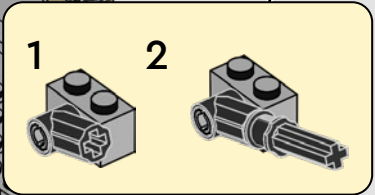
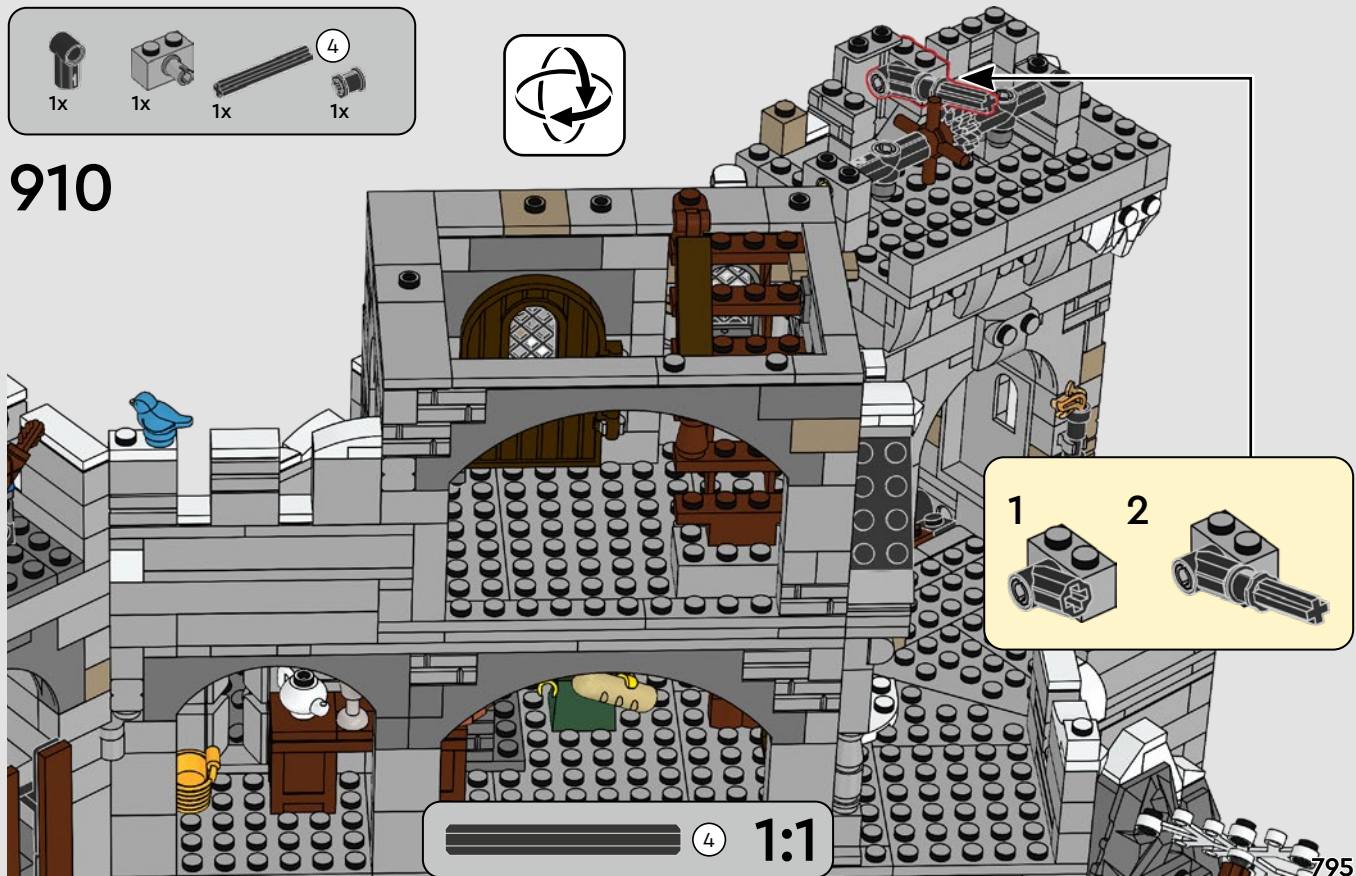

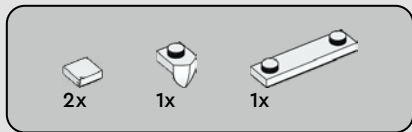

911

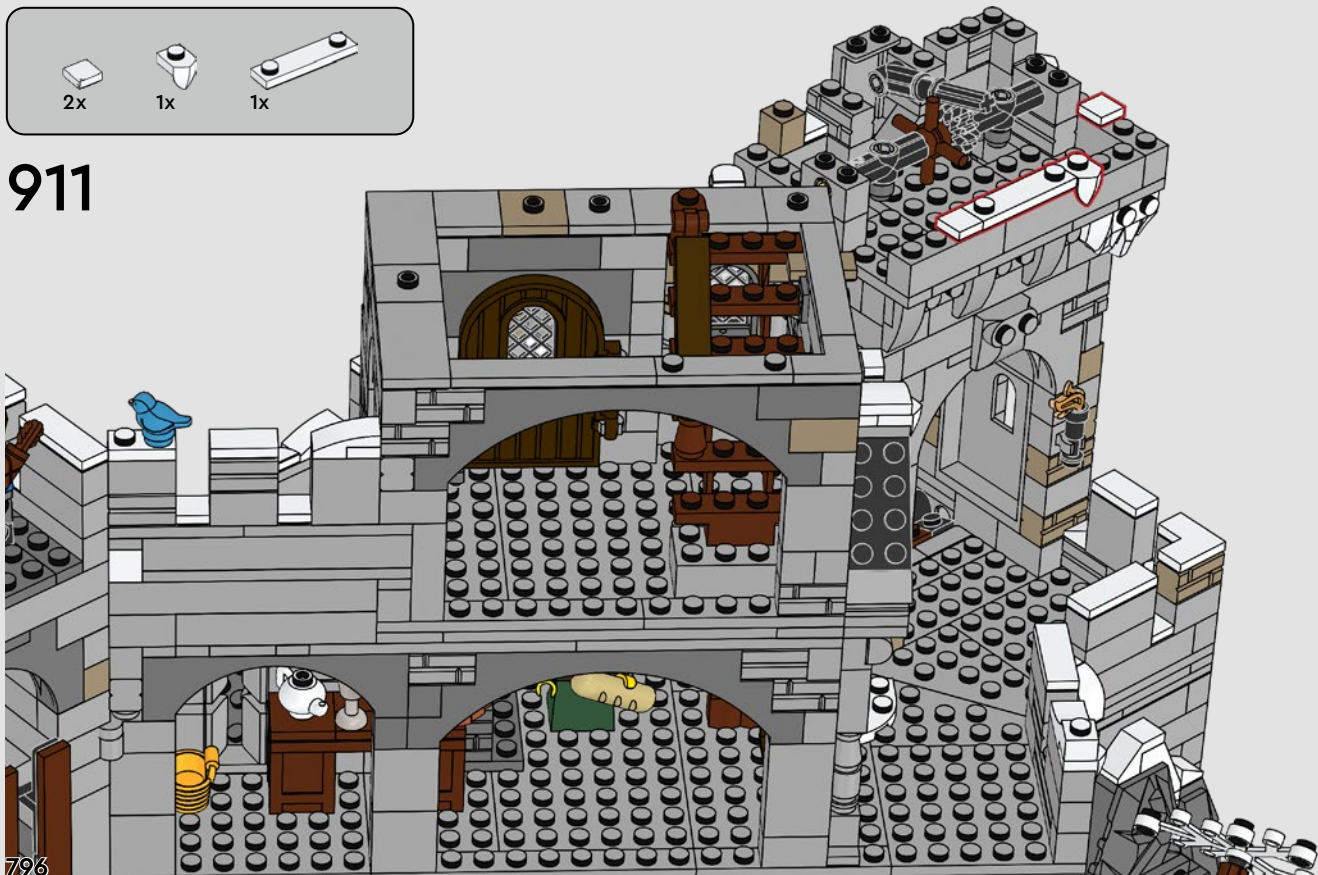

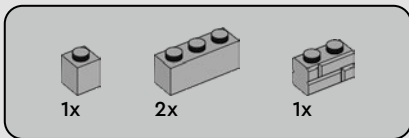

912

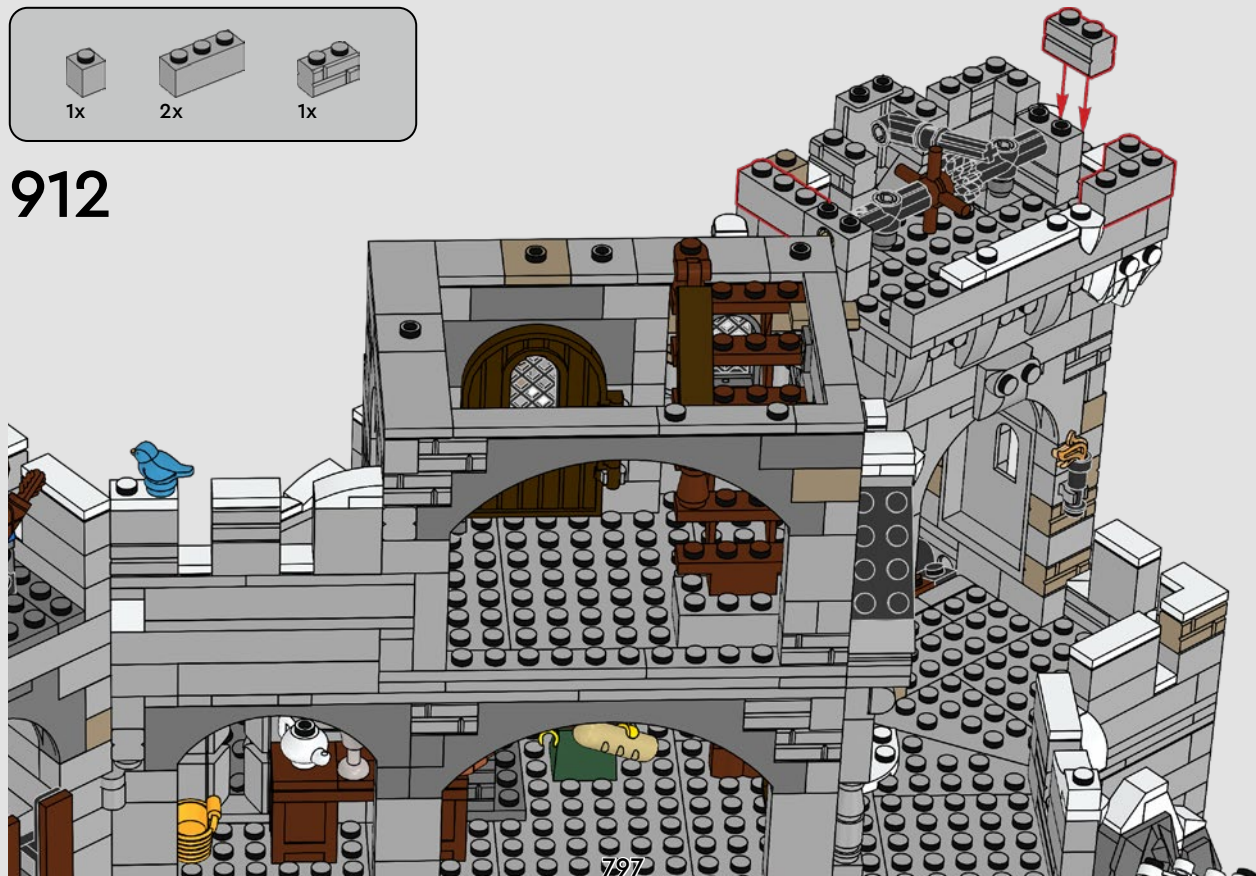



913

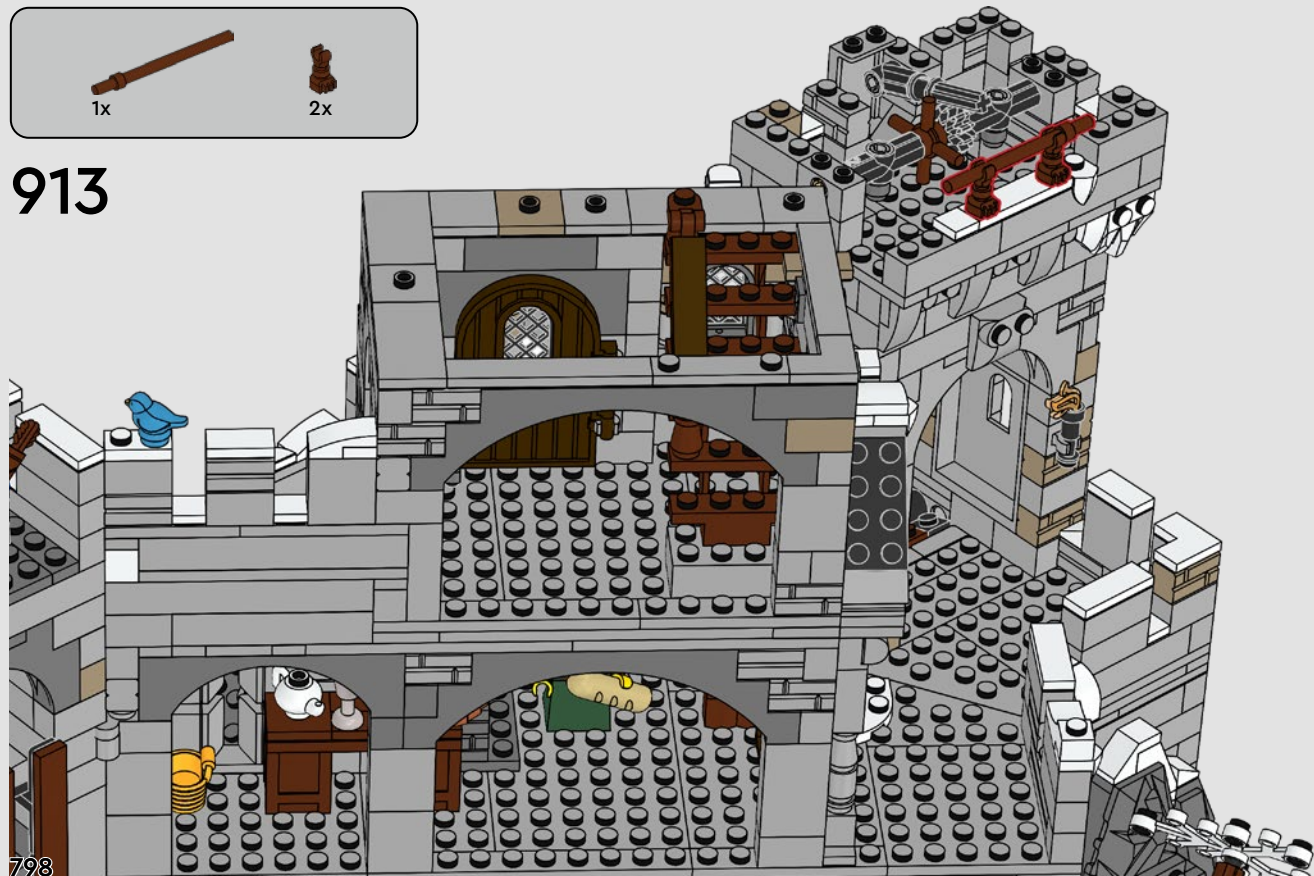

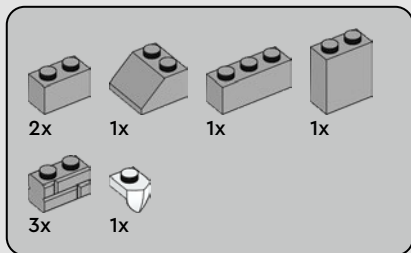

914

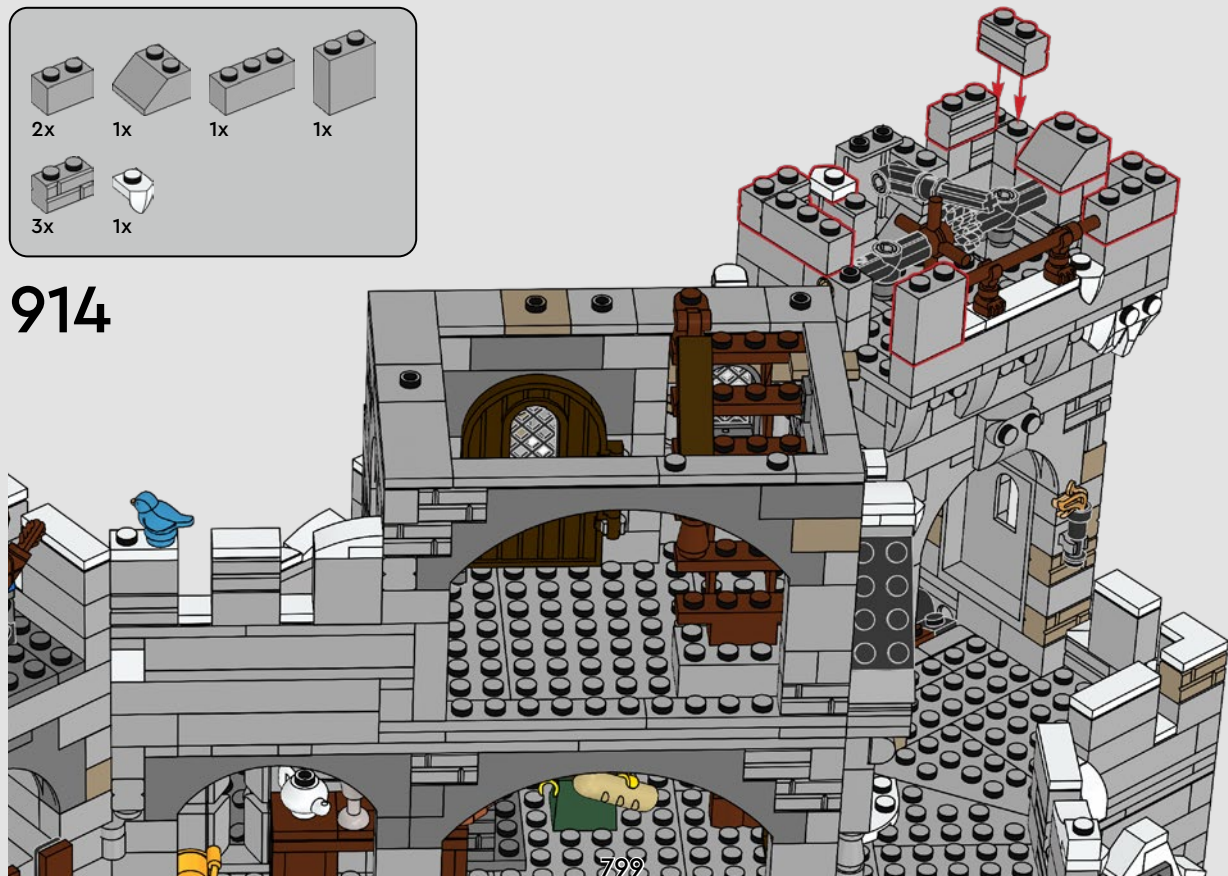

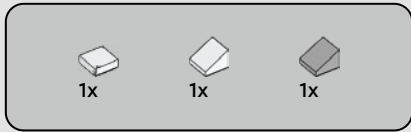

915

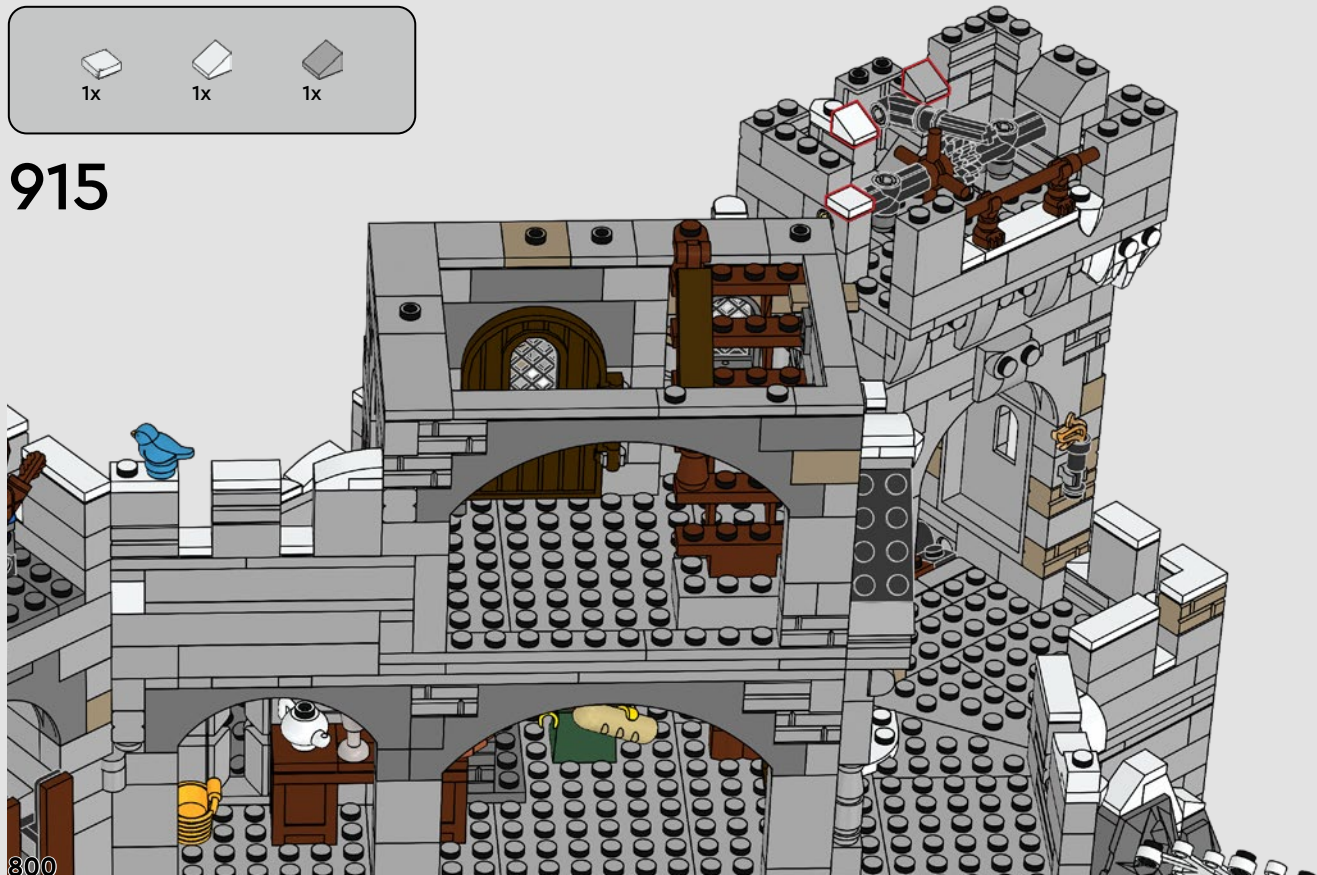



4x



1x

916

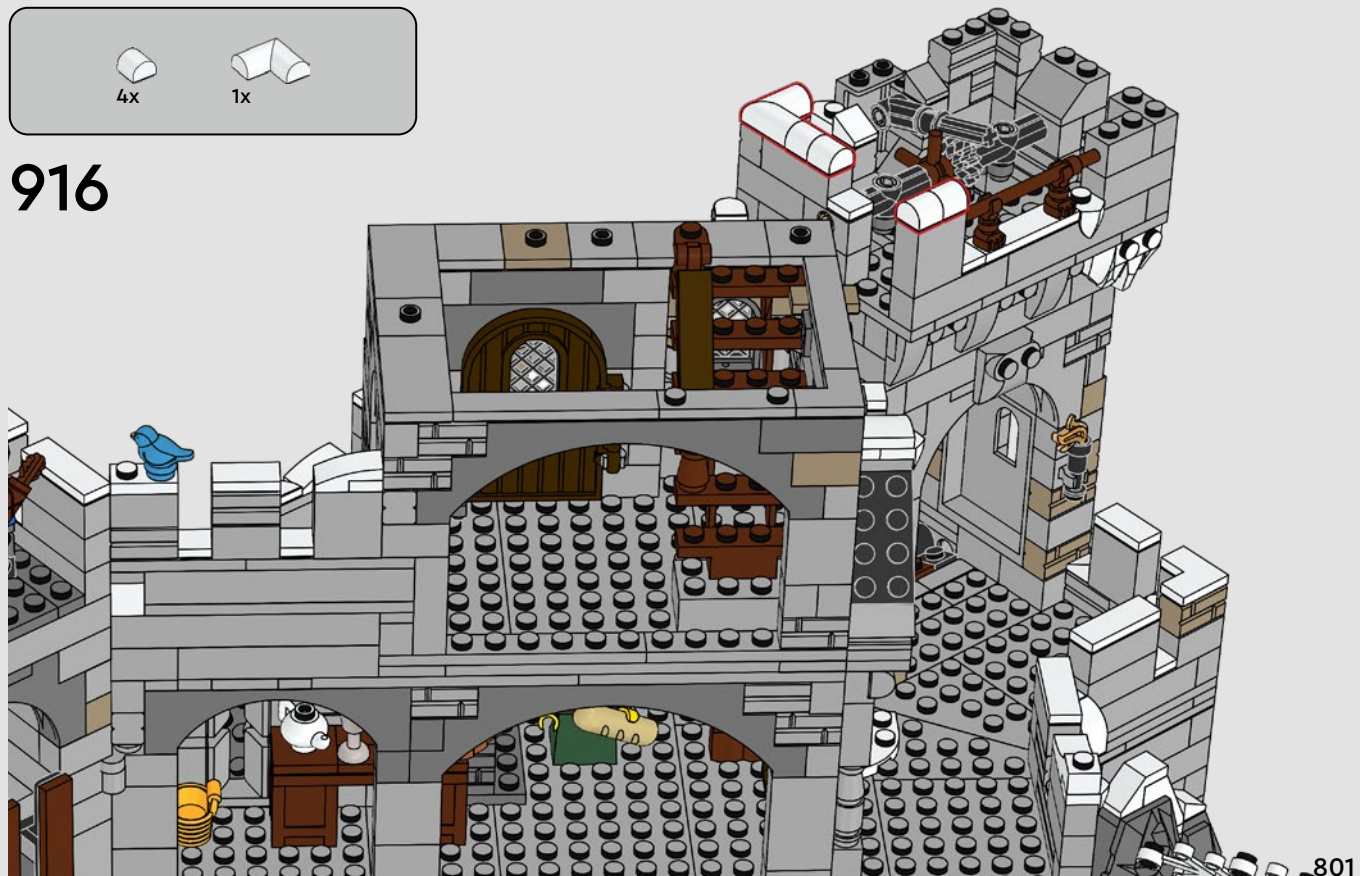



2x



2x

917

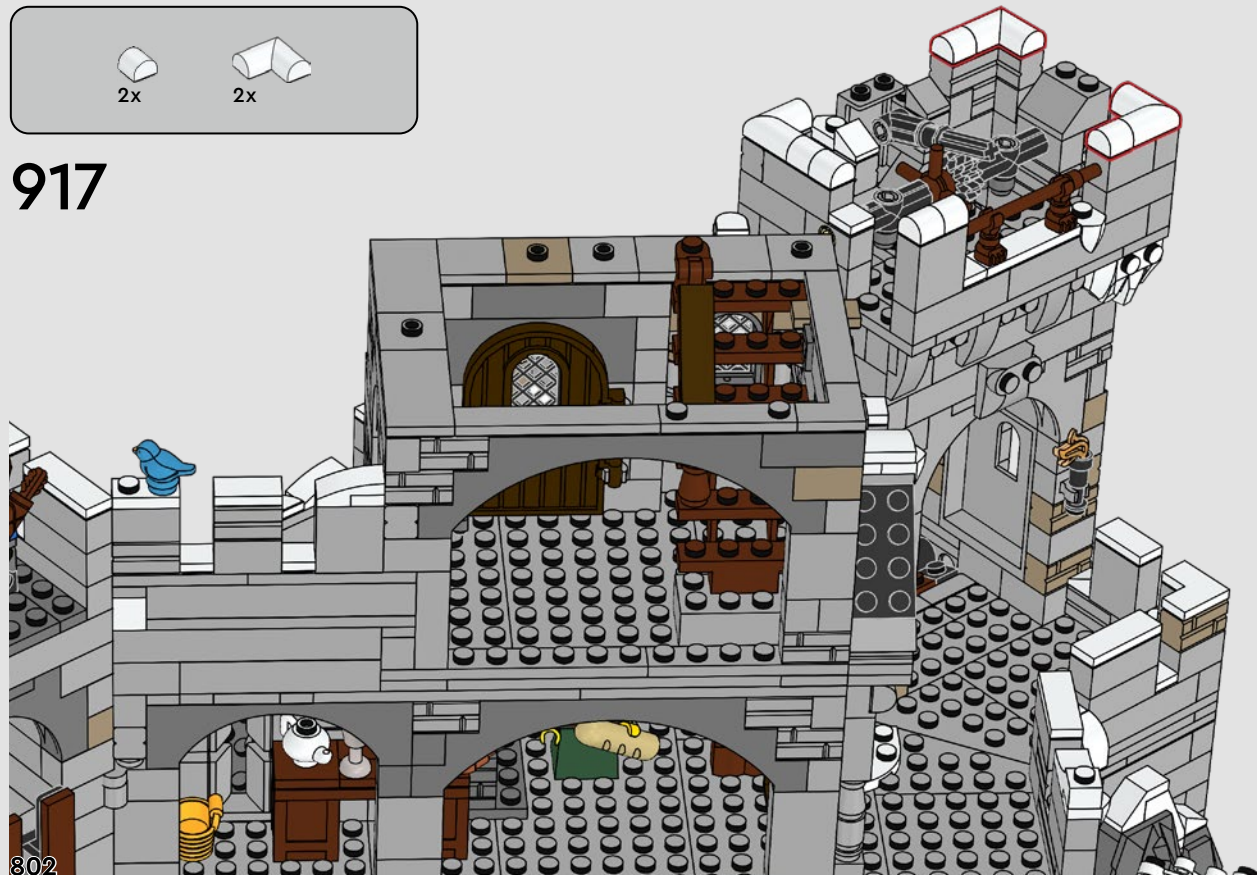



1x



1x

918

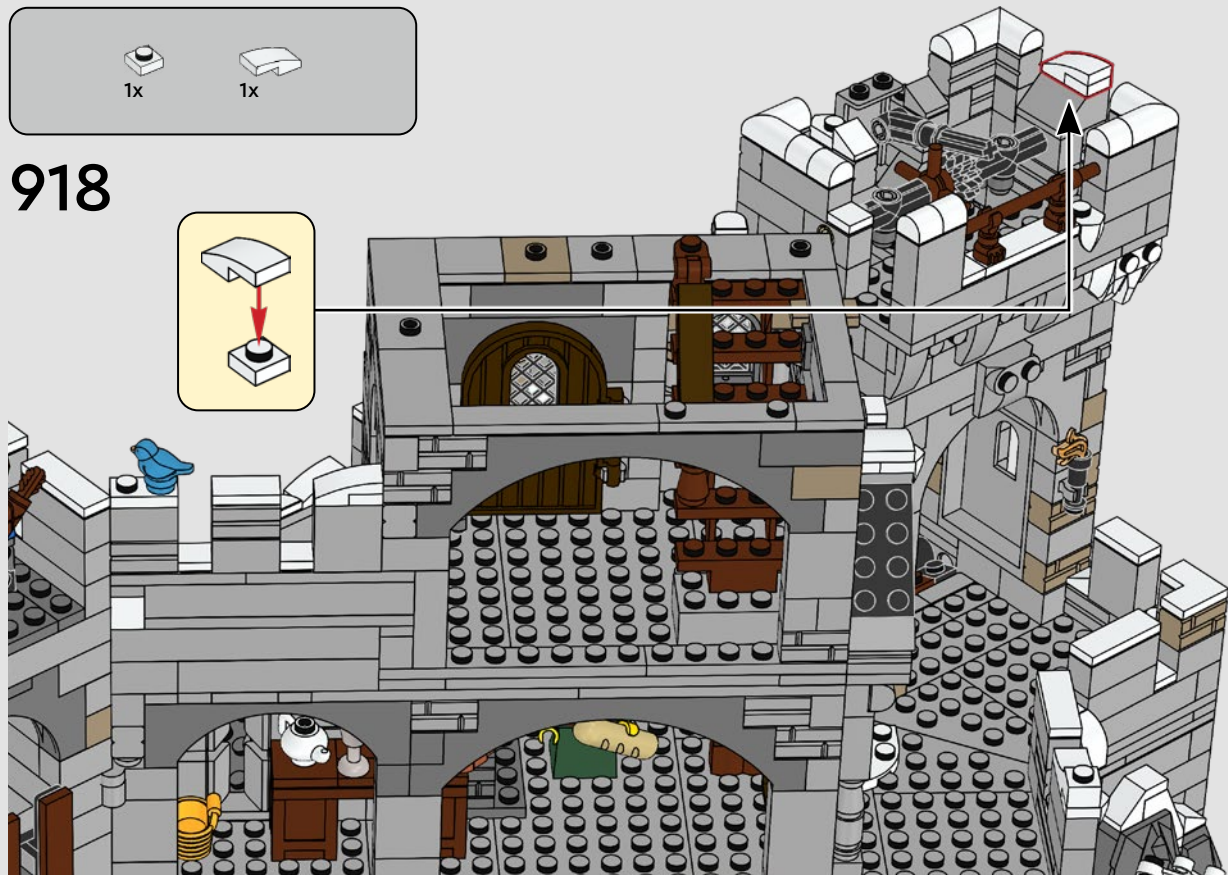
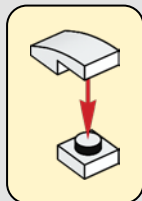



1x



1x

919

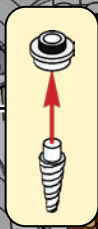
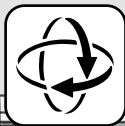

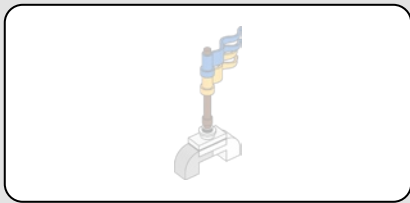

920

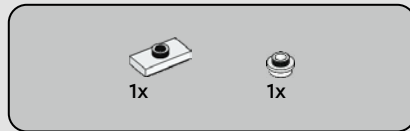

921

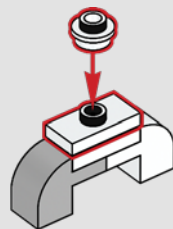

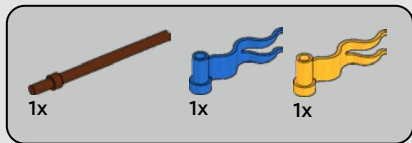

922

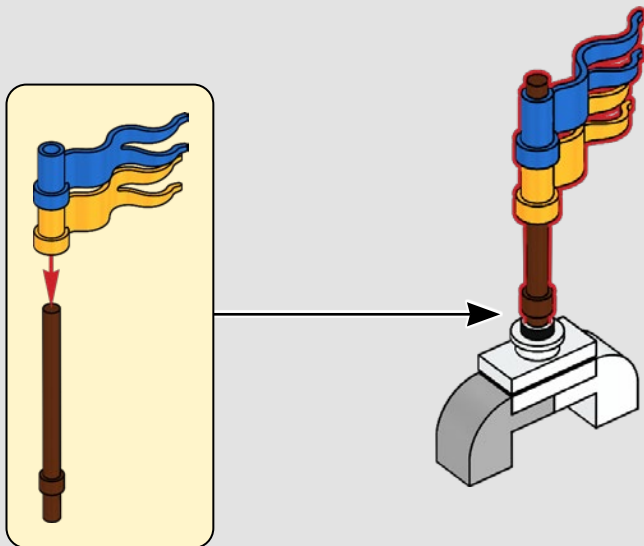

923



924



808

925





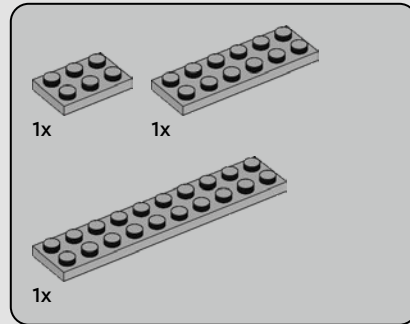
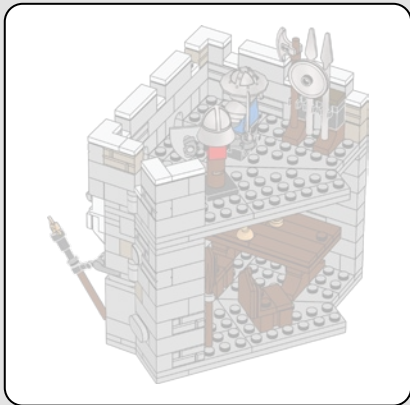

926

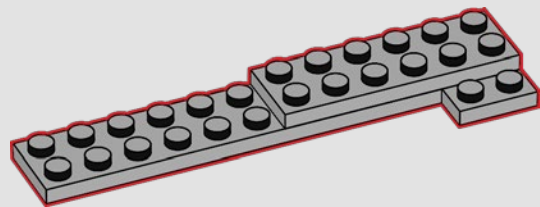

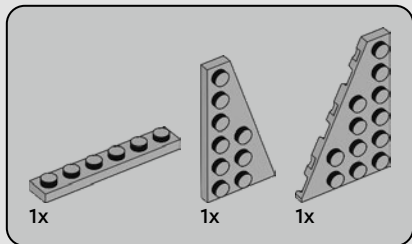

927

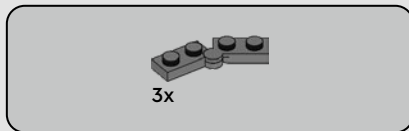
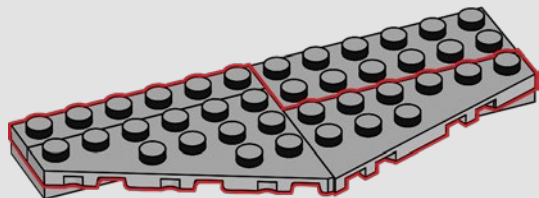

928

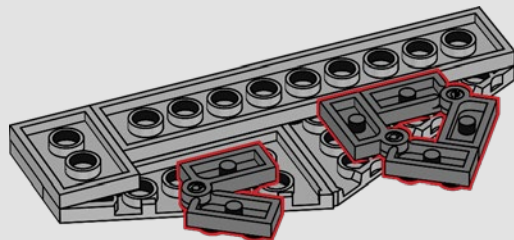

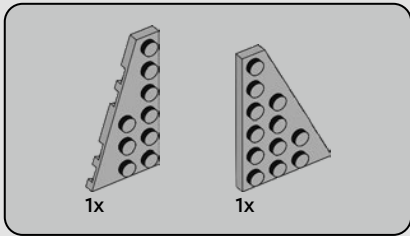

929

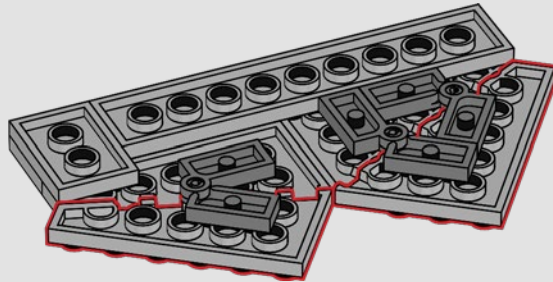

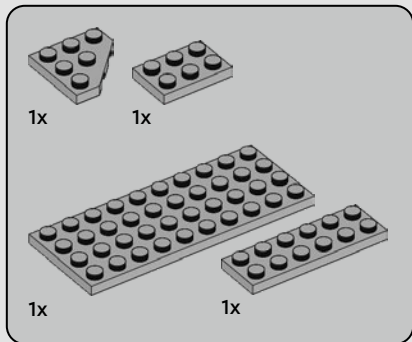

930

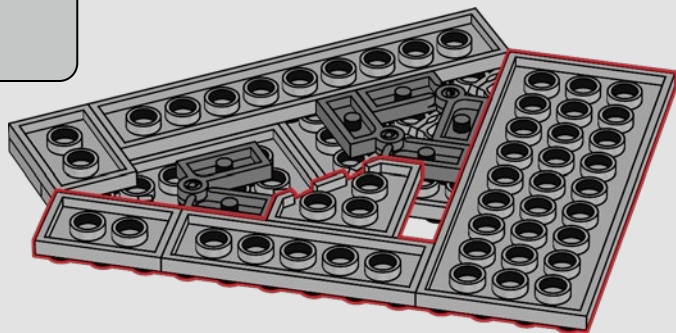

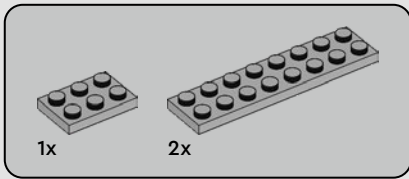

931

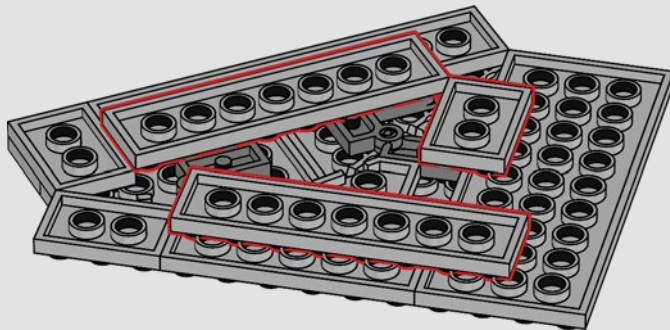

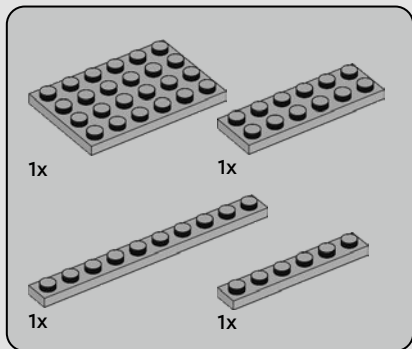

932

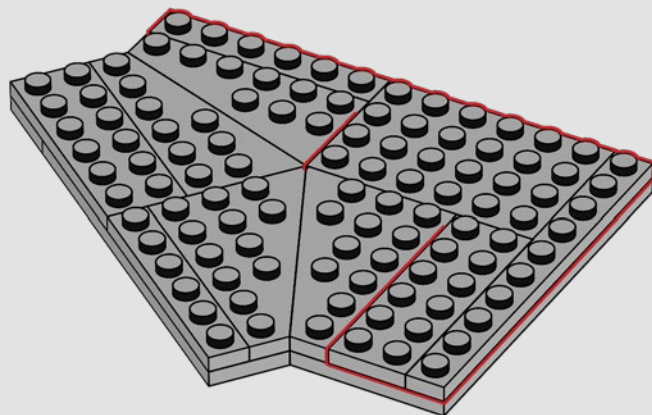



1x



1x

933

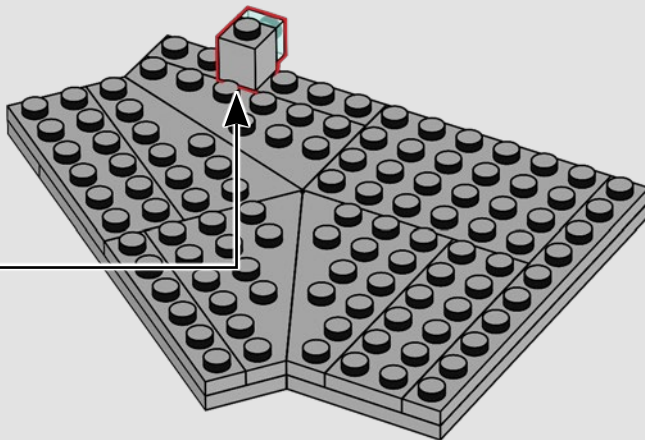
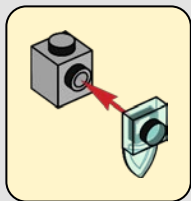

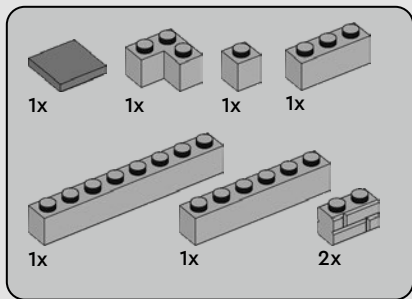

934

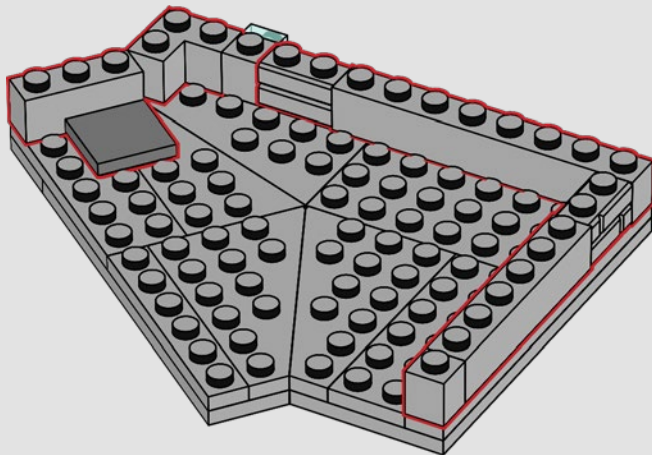

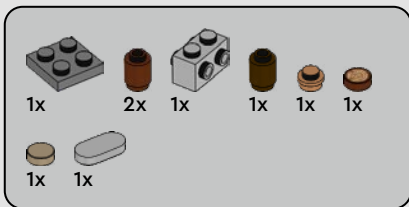

935

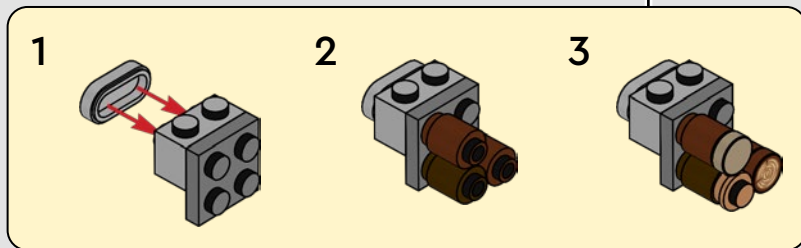
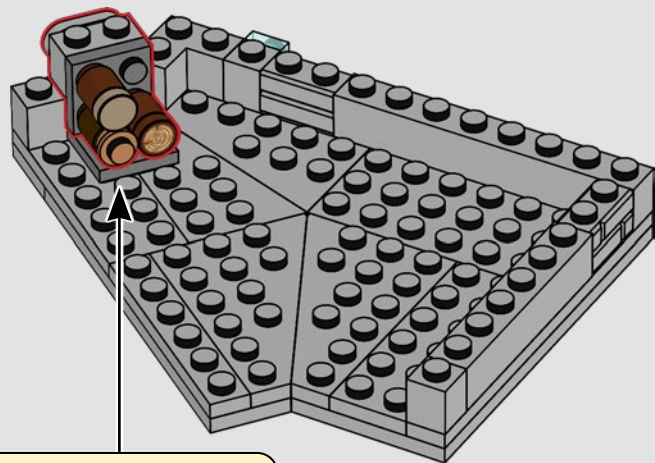

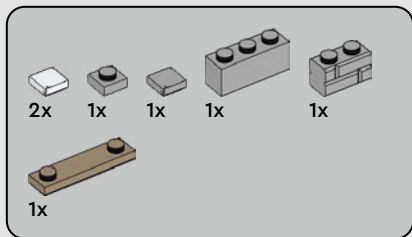

936

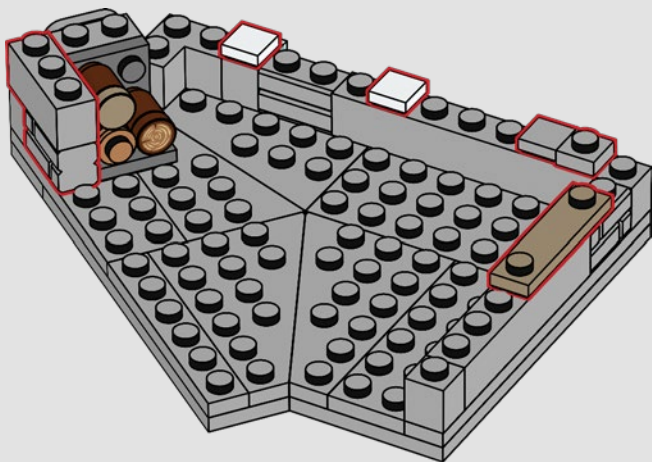

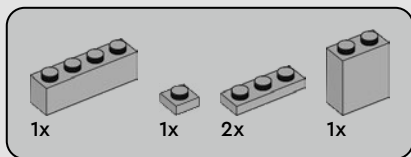

937

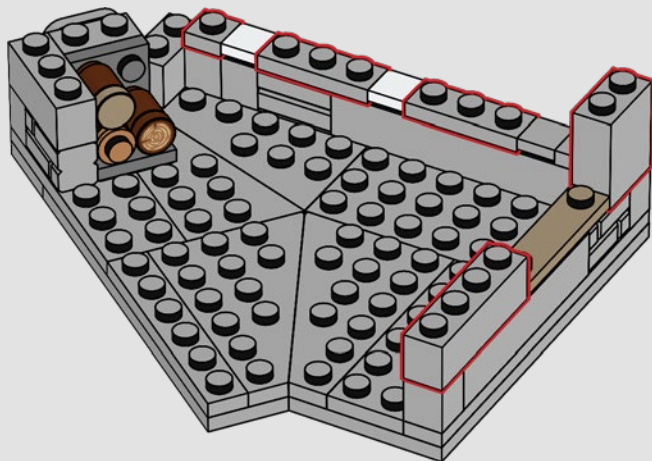

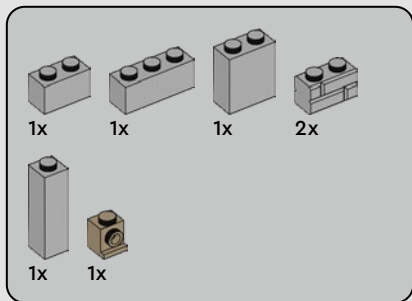

938

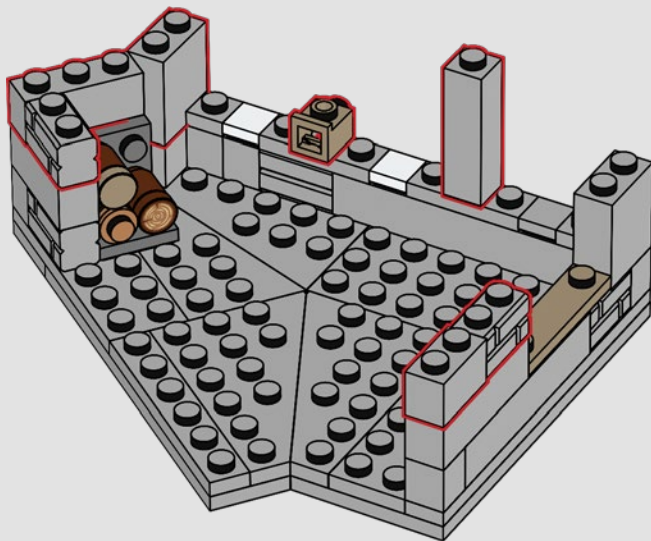

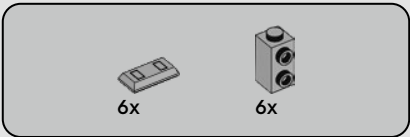

939

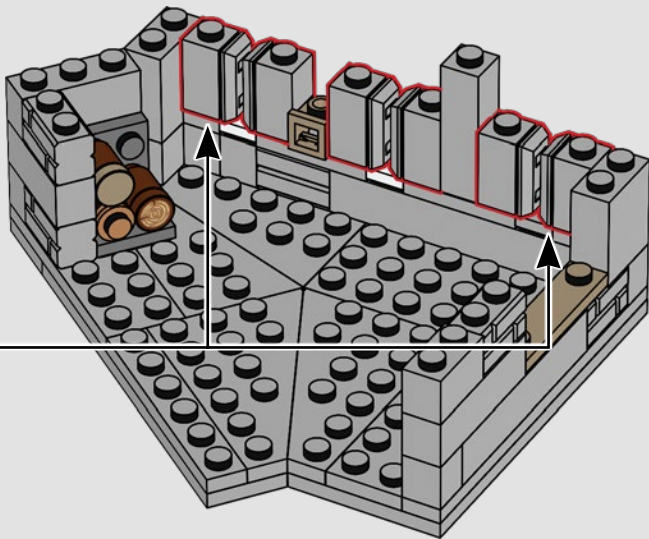
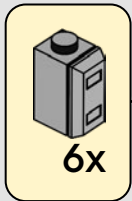



1x



1x

940

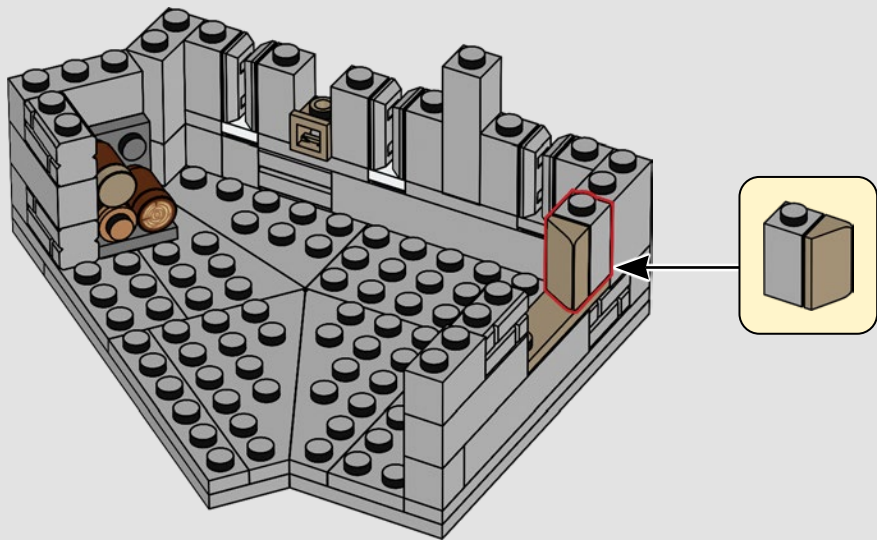



1x



1x

941

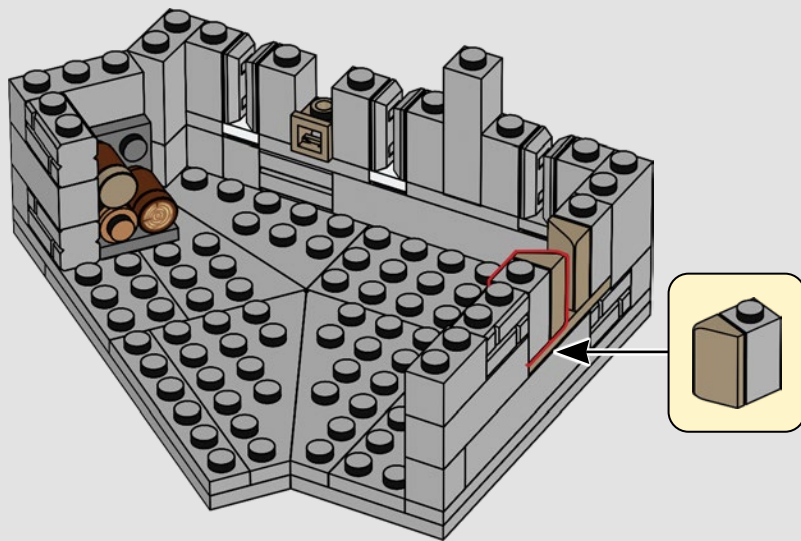

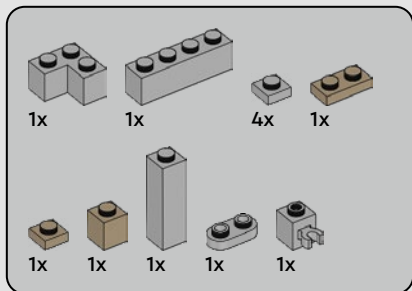

942

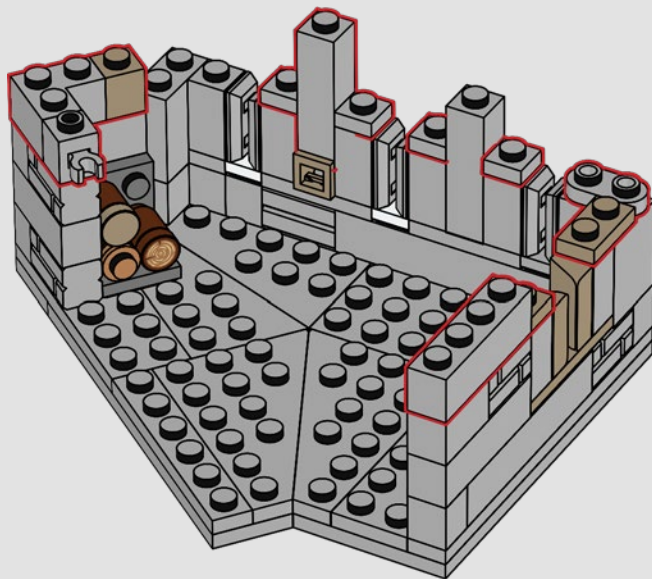



1x



1x



1x



1x

943

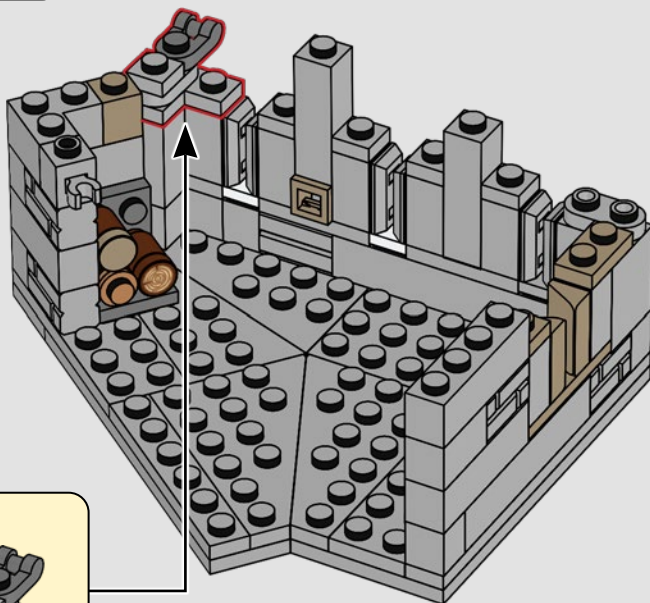

1

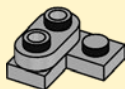

2

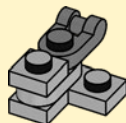

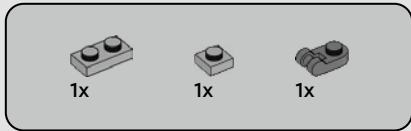

944

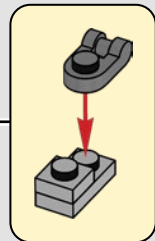
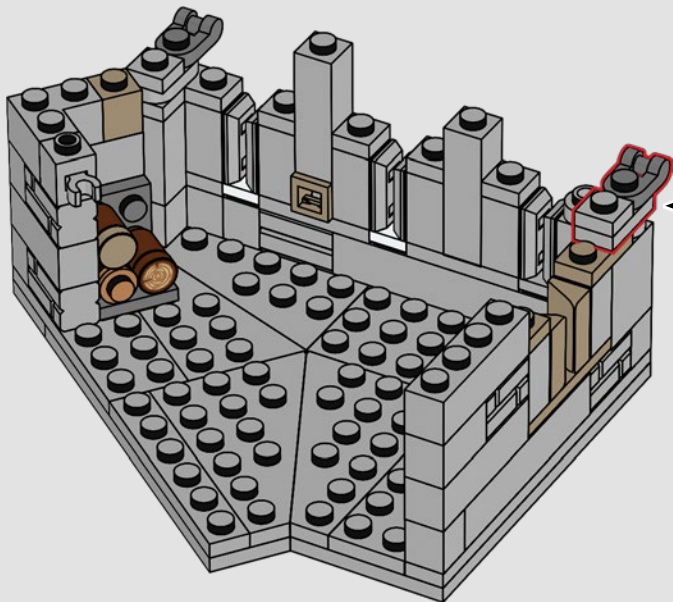



945

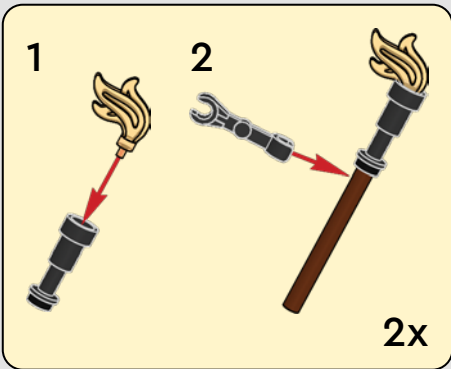
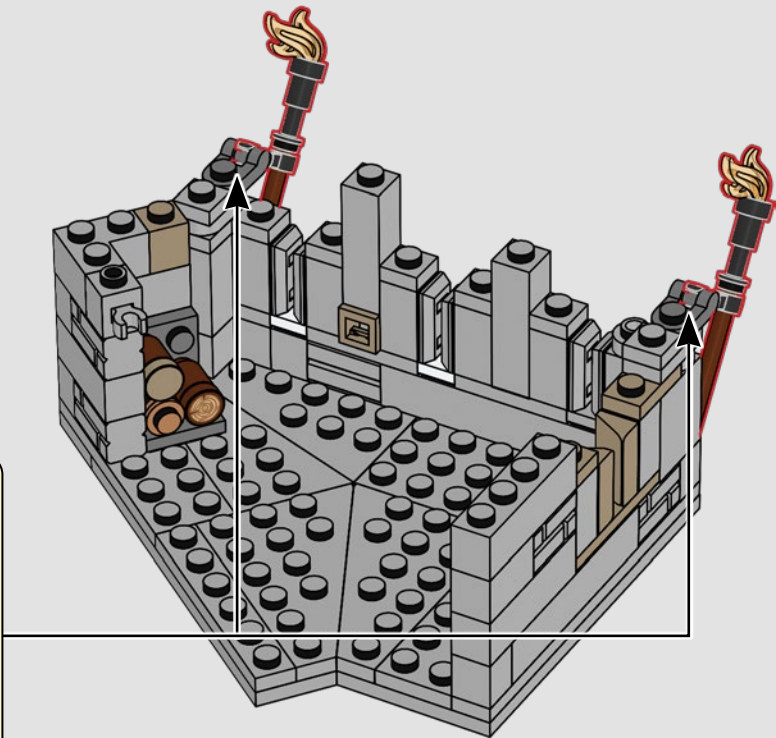

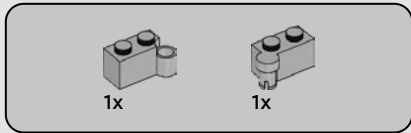

946

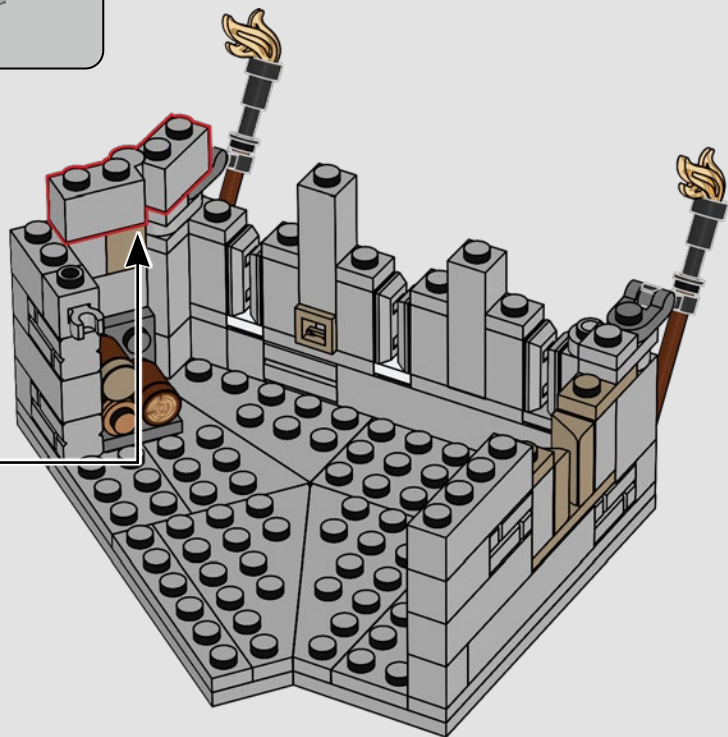
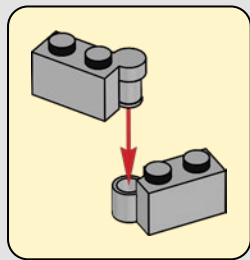

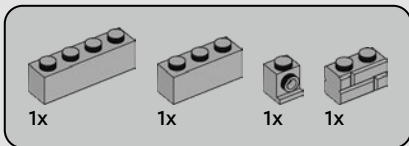

947

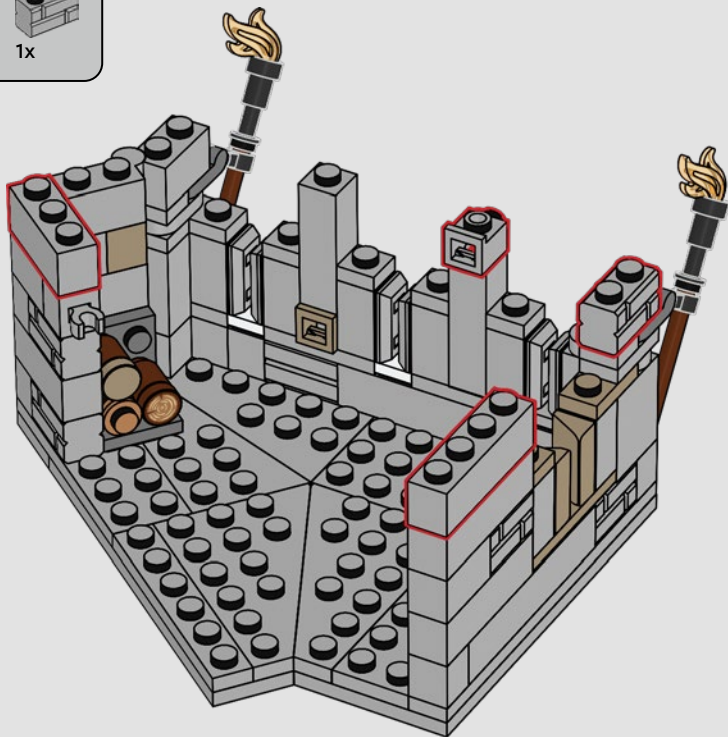

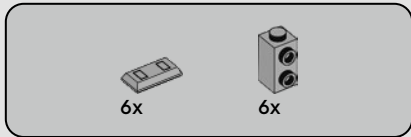

948

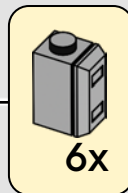
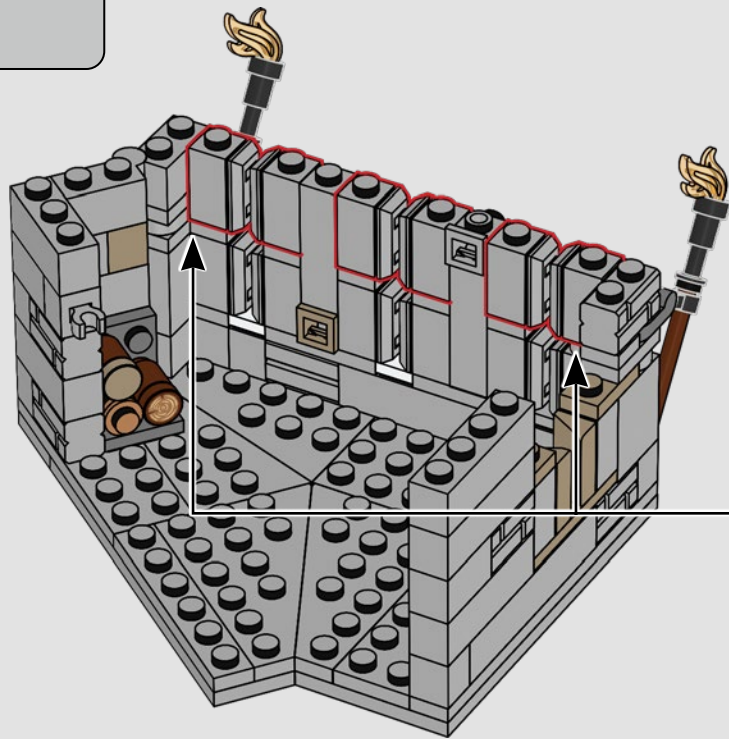

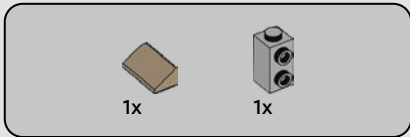

949

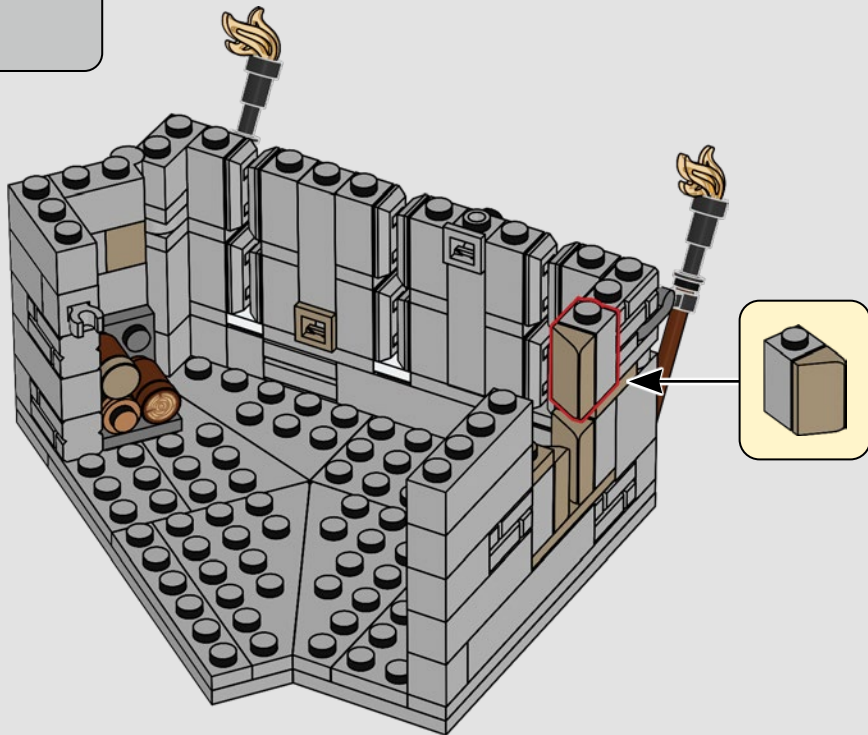



1x



1x

950

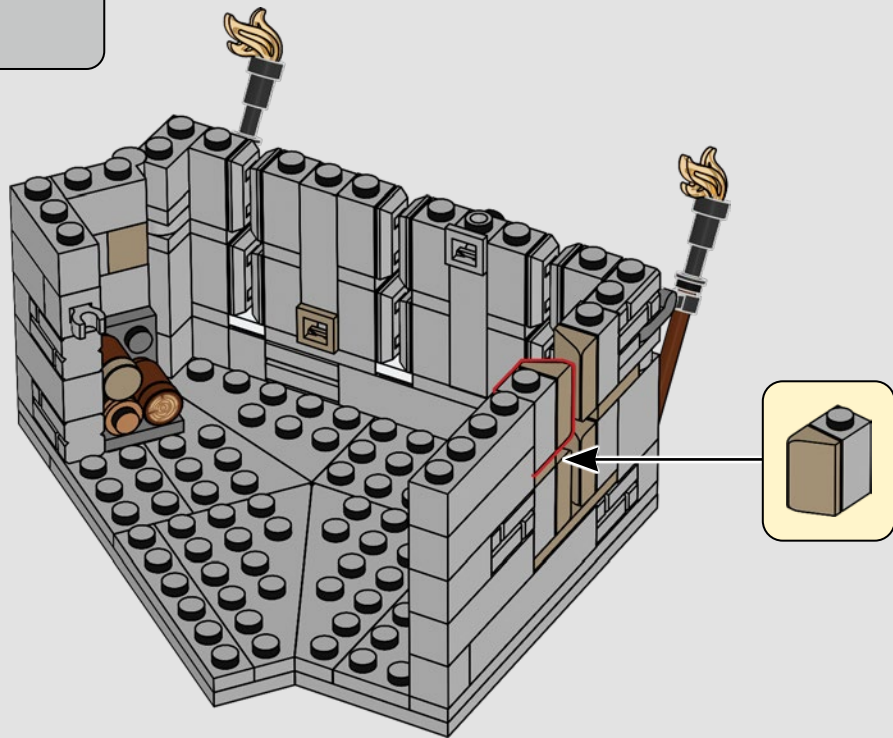

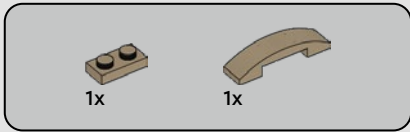

951

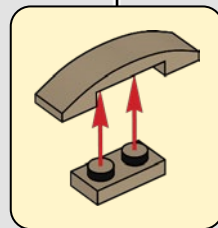
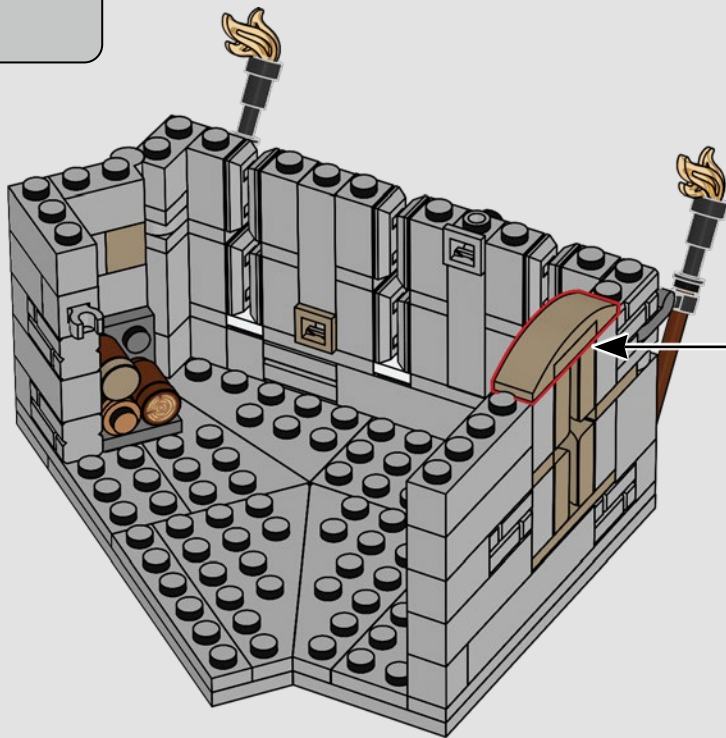



1x



1x

952

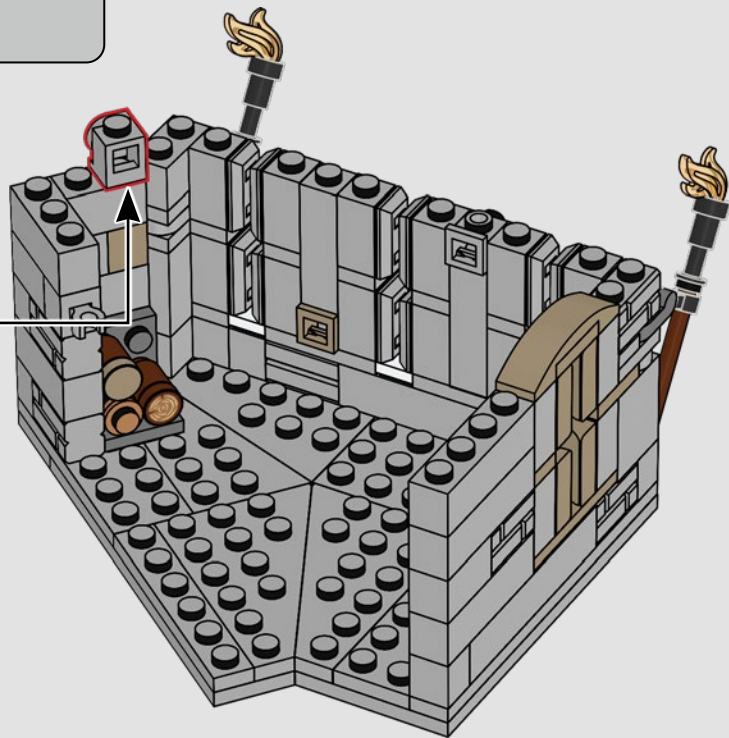
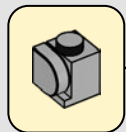

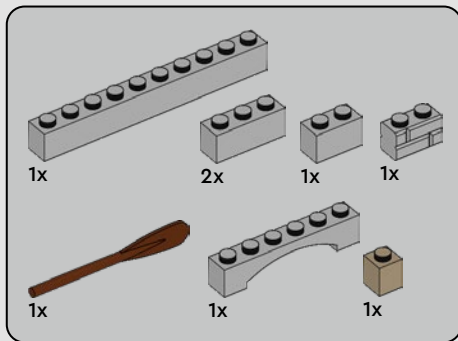

953

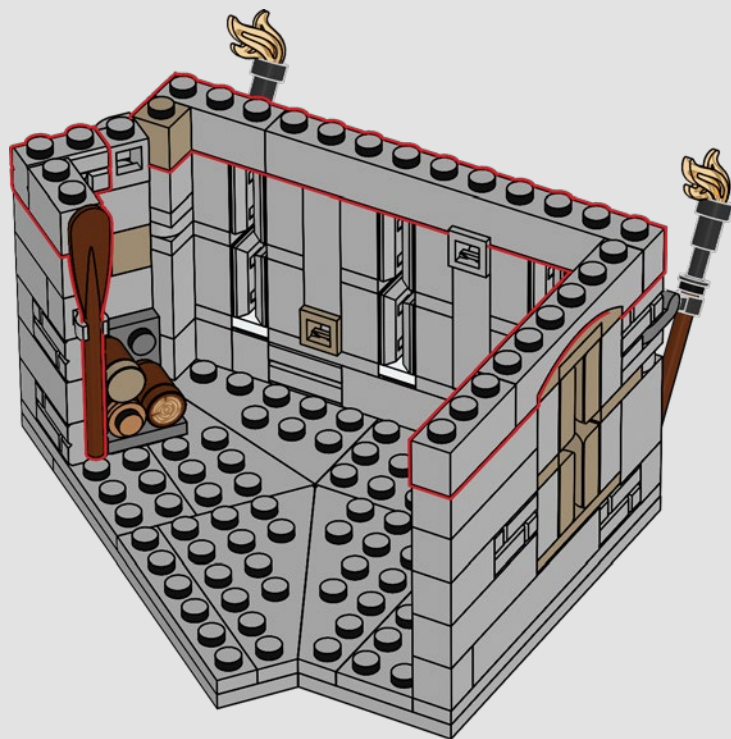

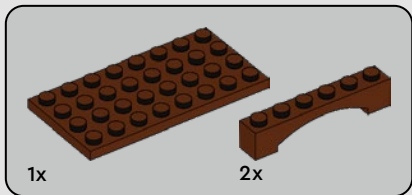

954

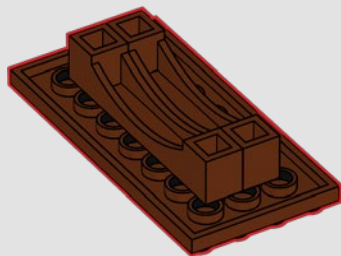



4x

955

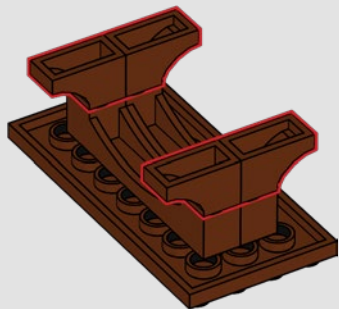

2x



2x



2x



956

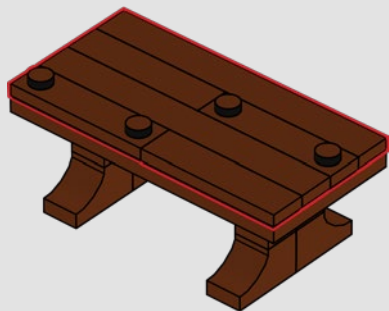

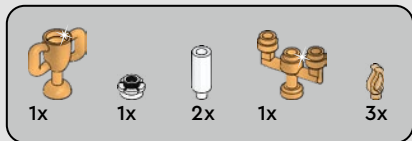

957

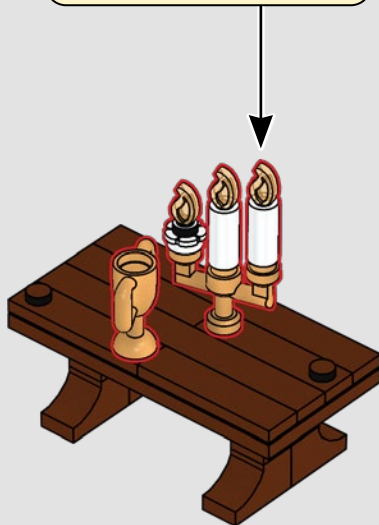
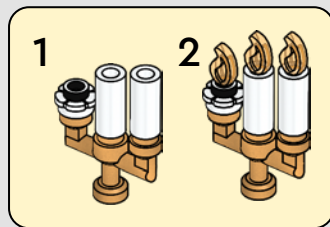

958

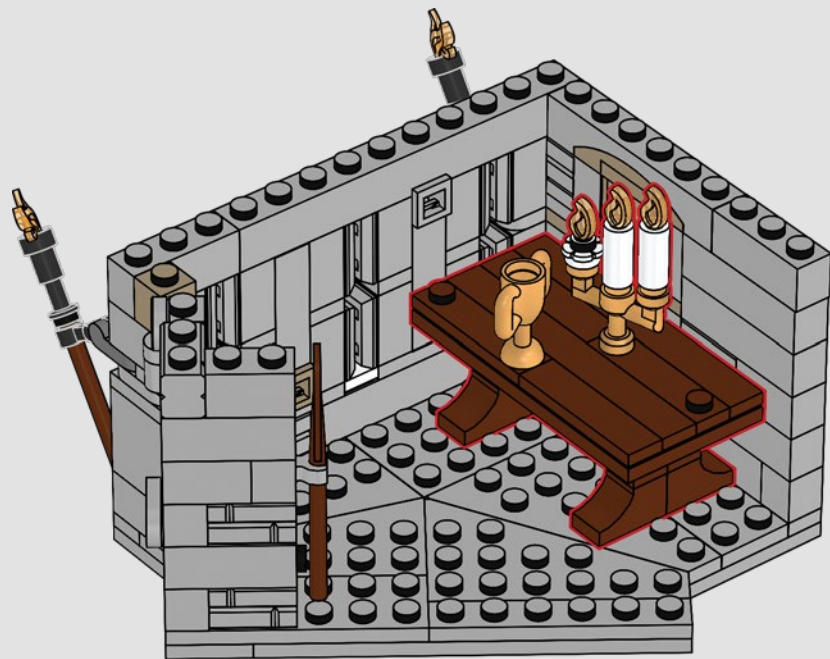

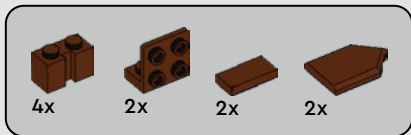

959

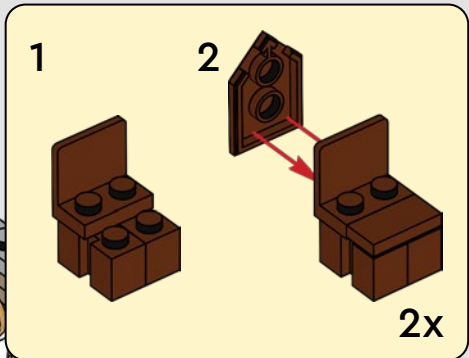
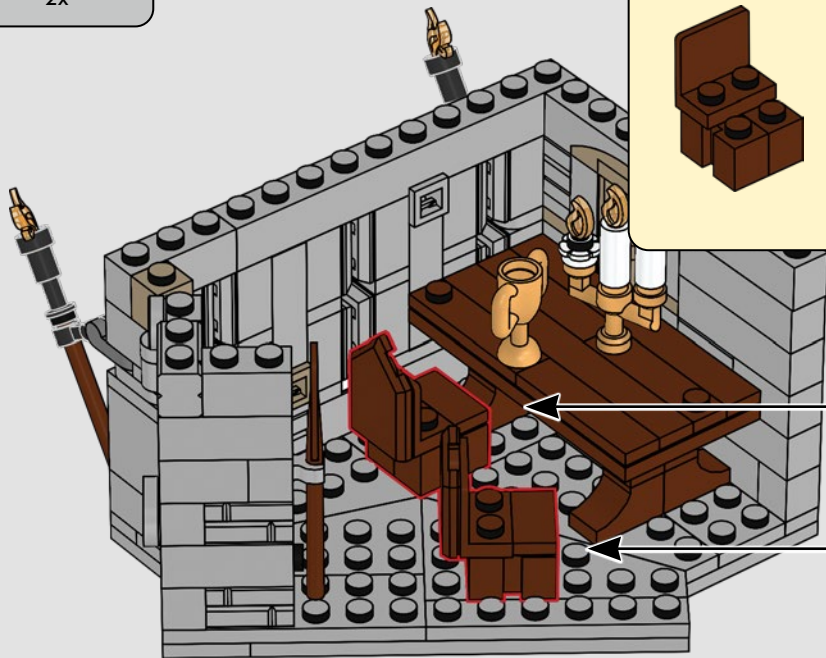

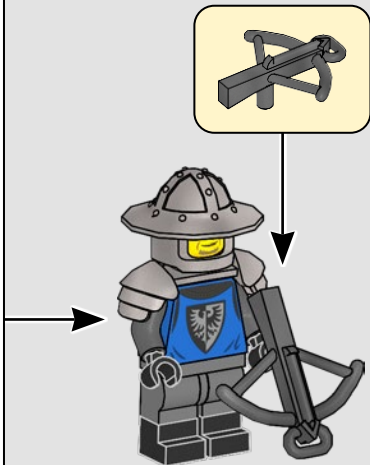
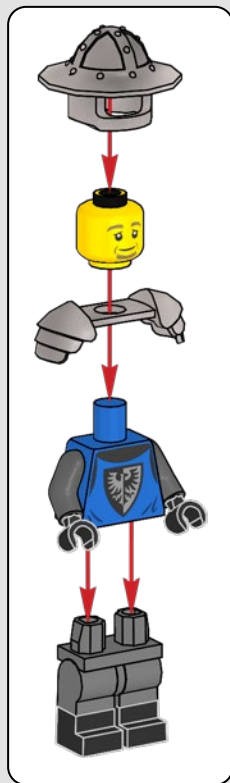

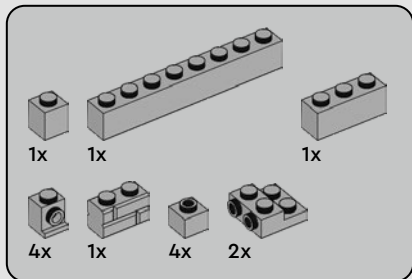

960

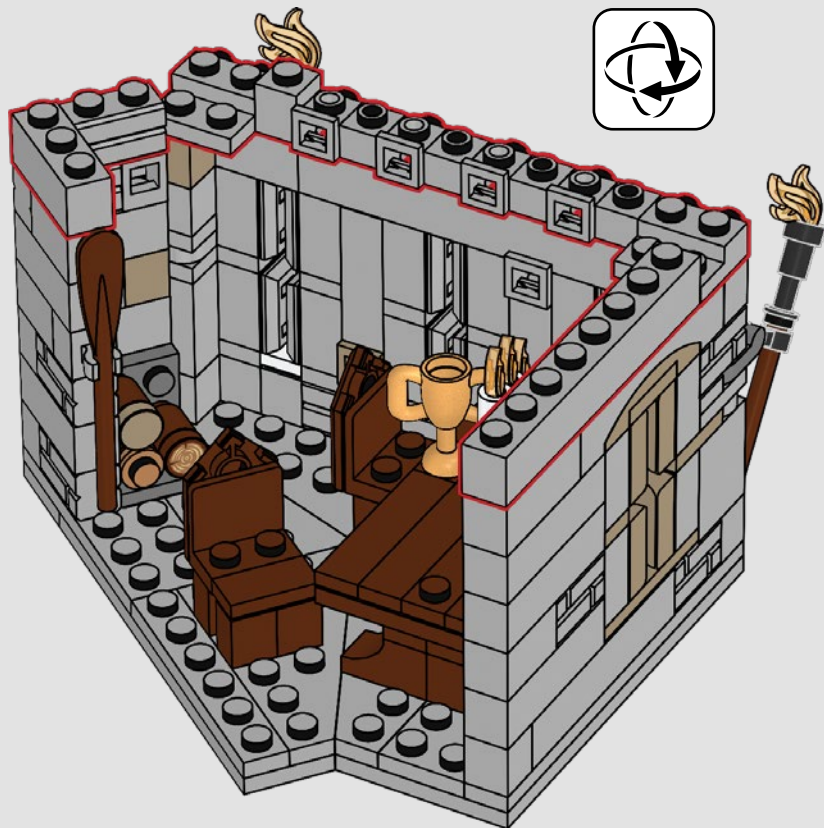



1x



1x

962

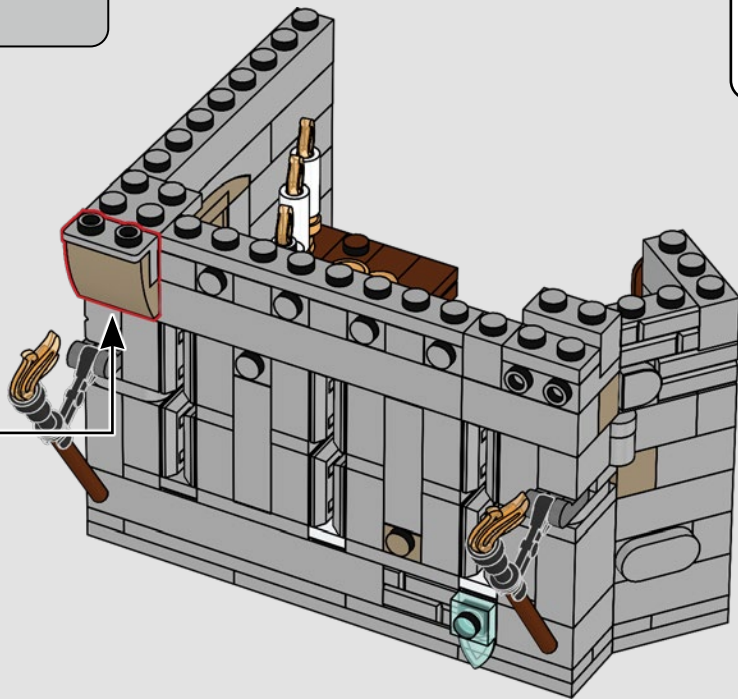
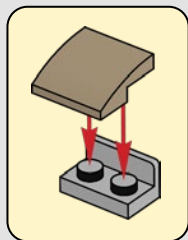



4x



4x

963

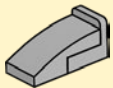
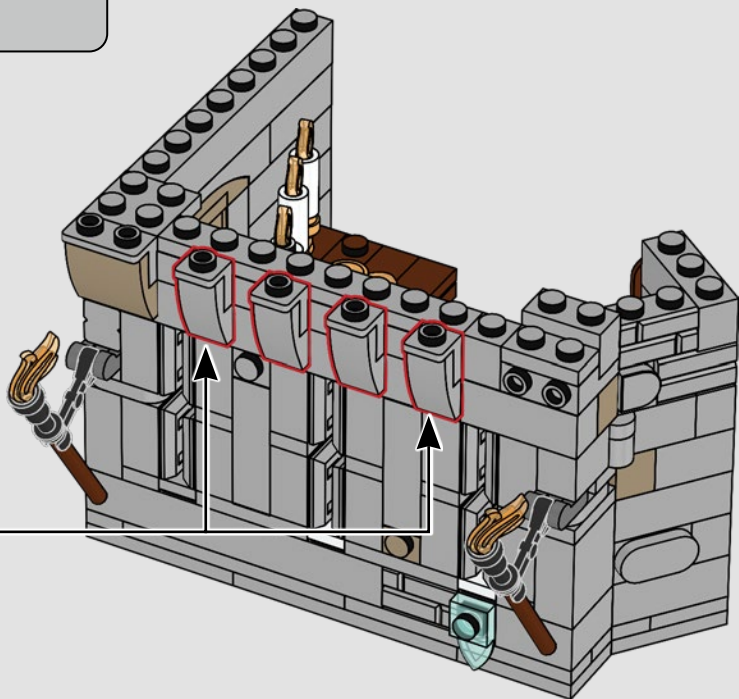

4x

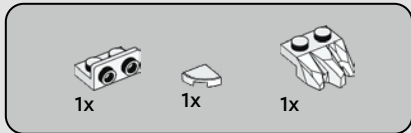

964

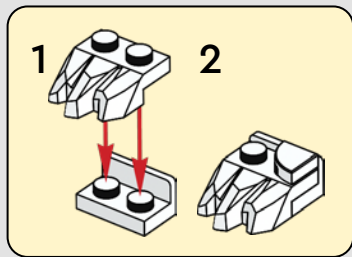
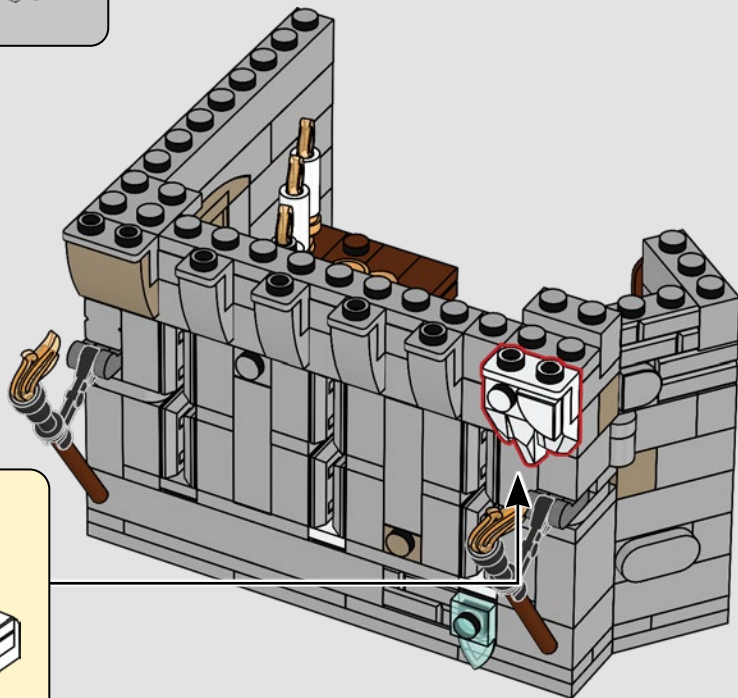



1x



1x

966

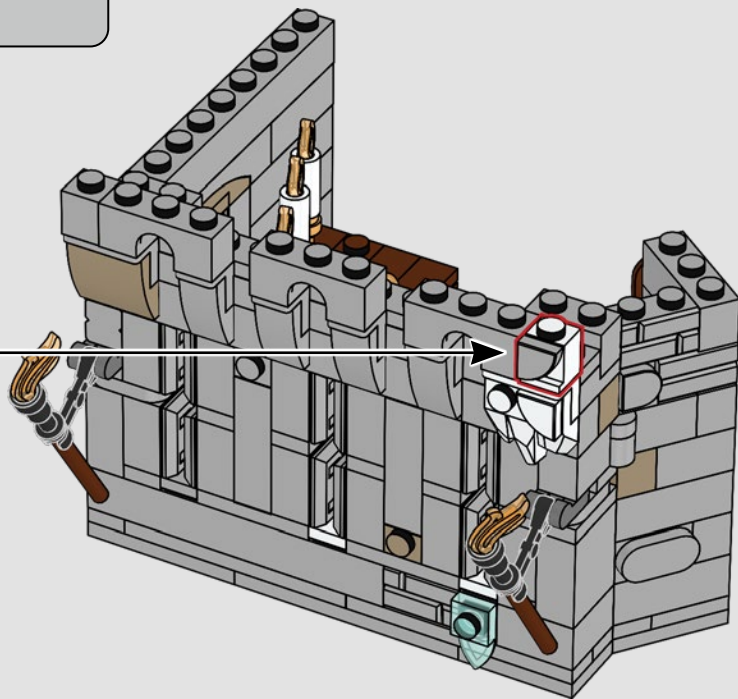

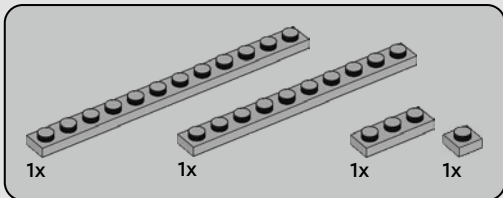

967

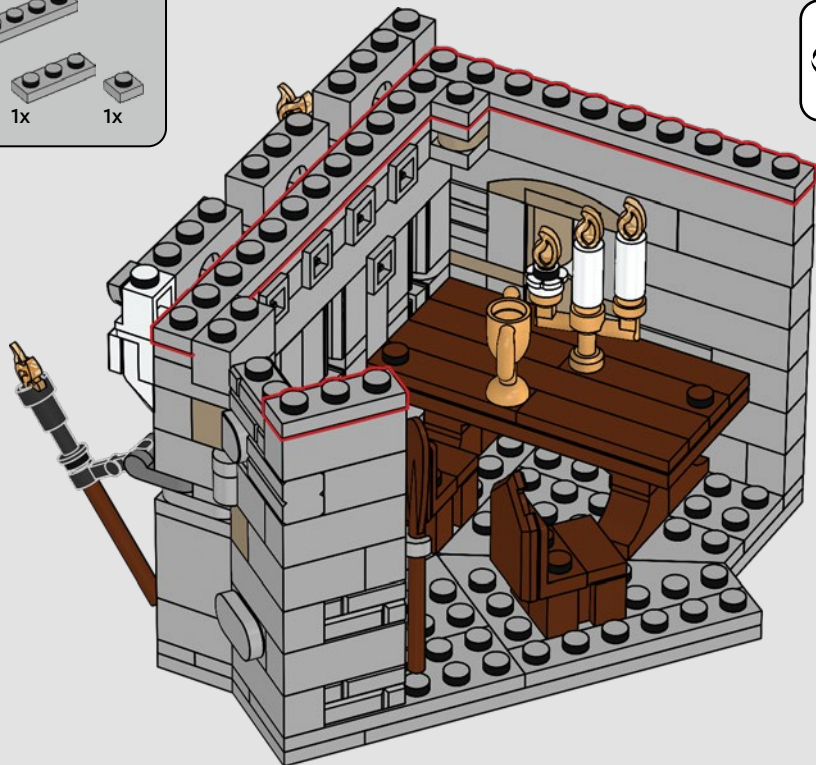
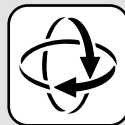



2x

968

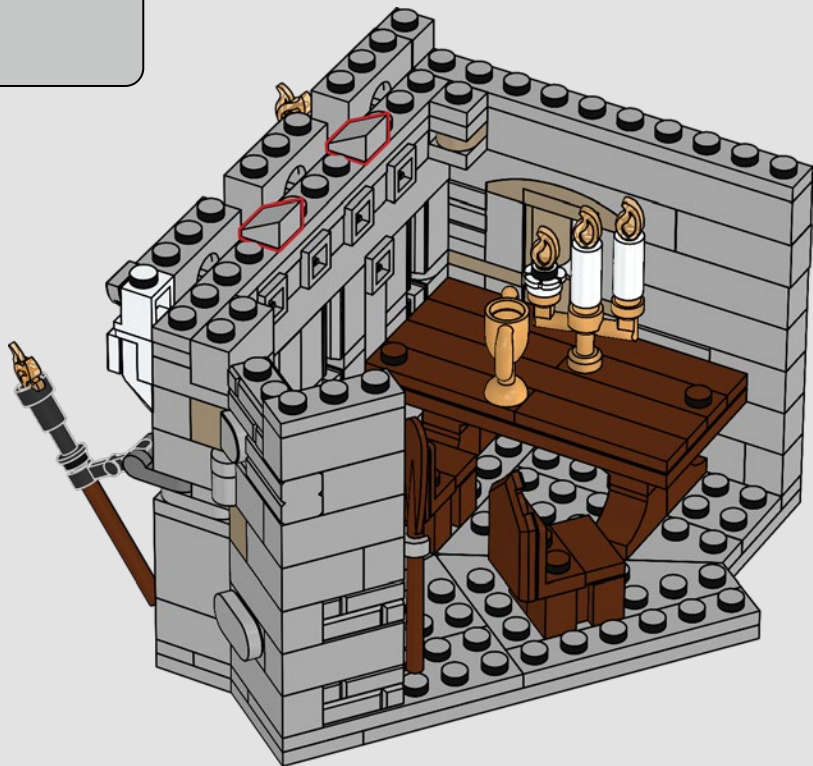

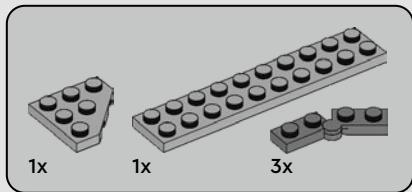

971

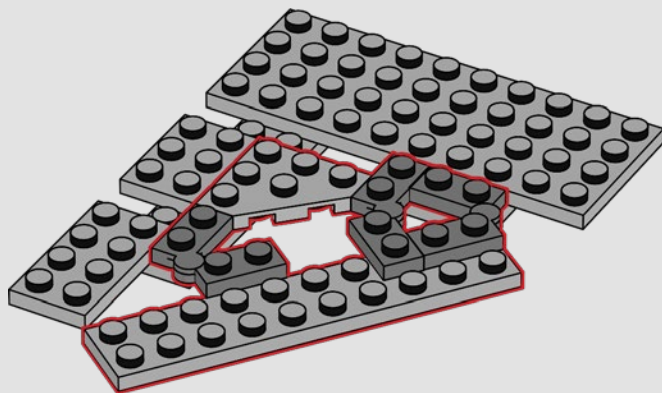

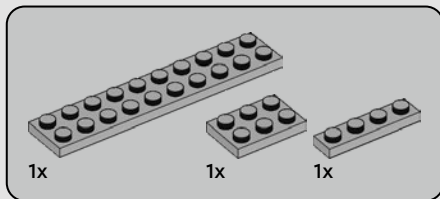

972

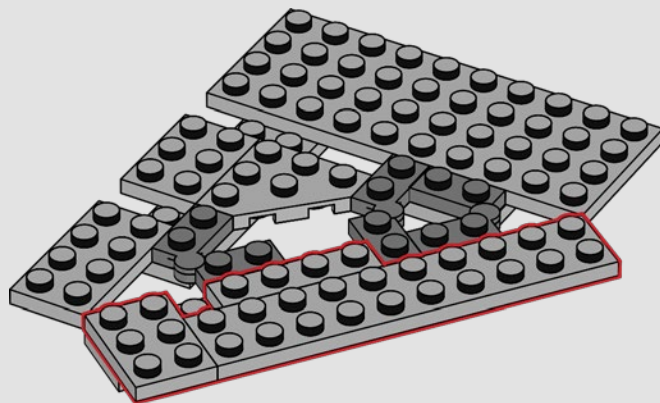

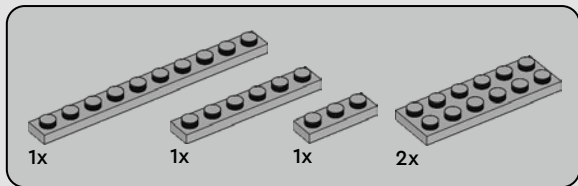

973

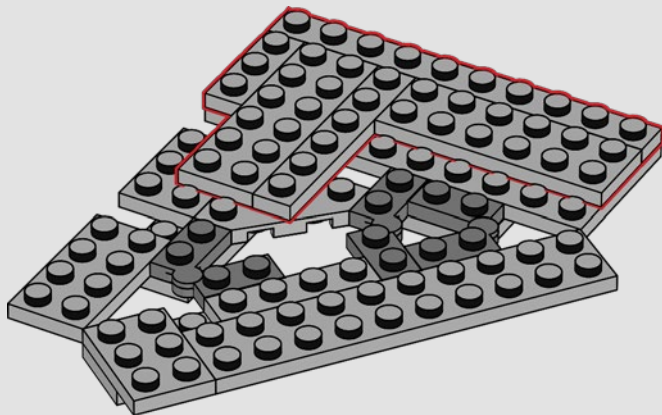

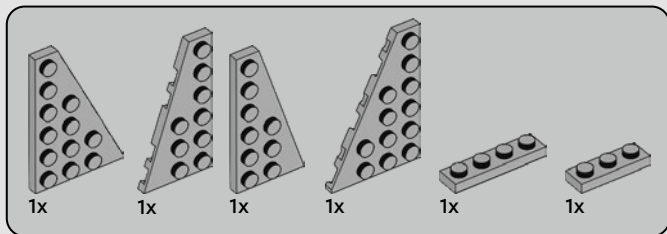

974

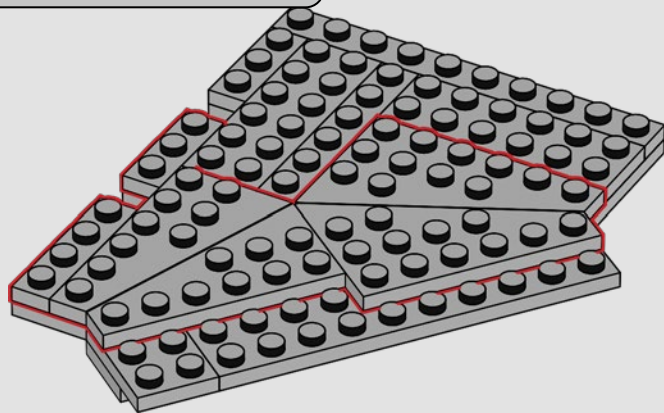

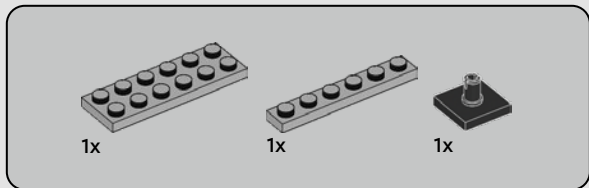

975

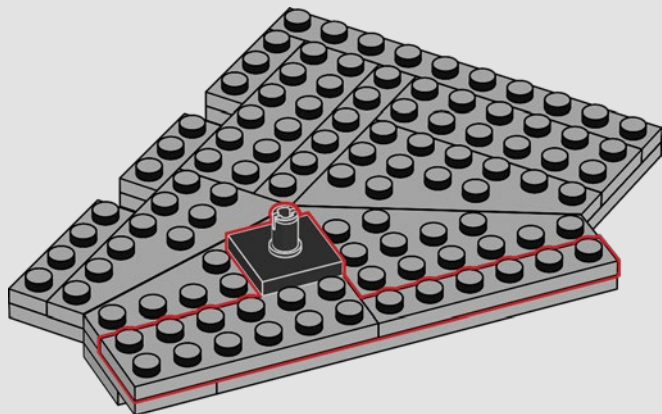

976

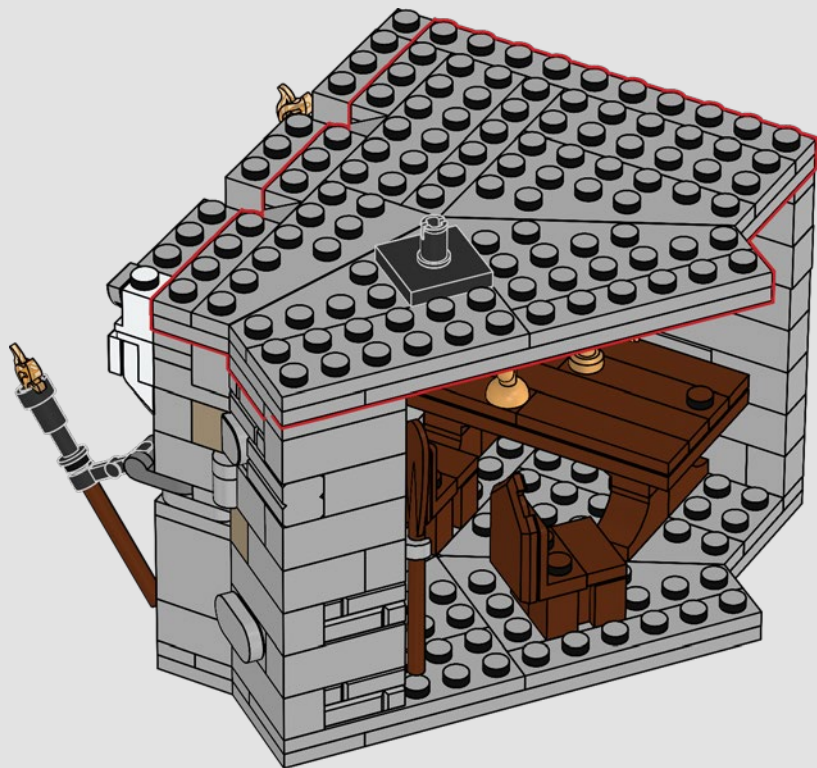

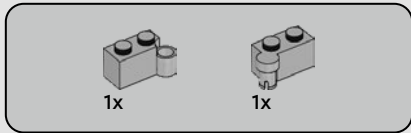

977

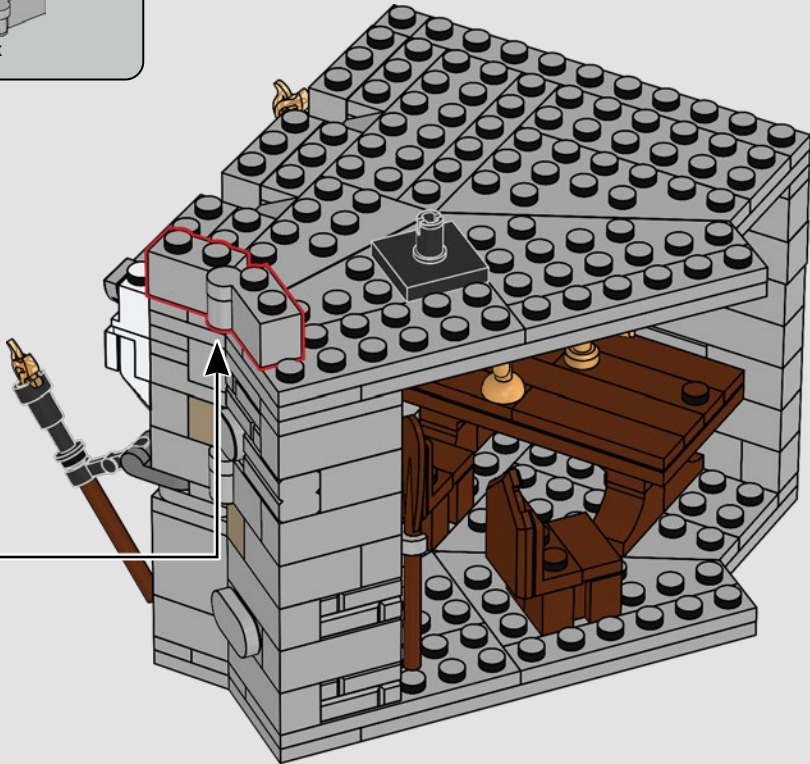
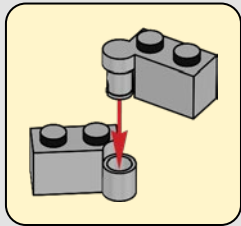

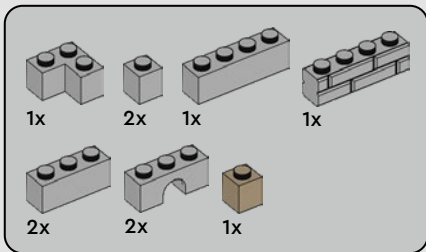

978

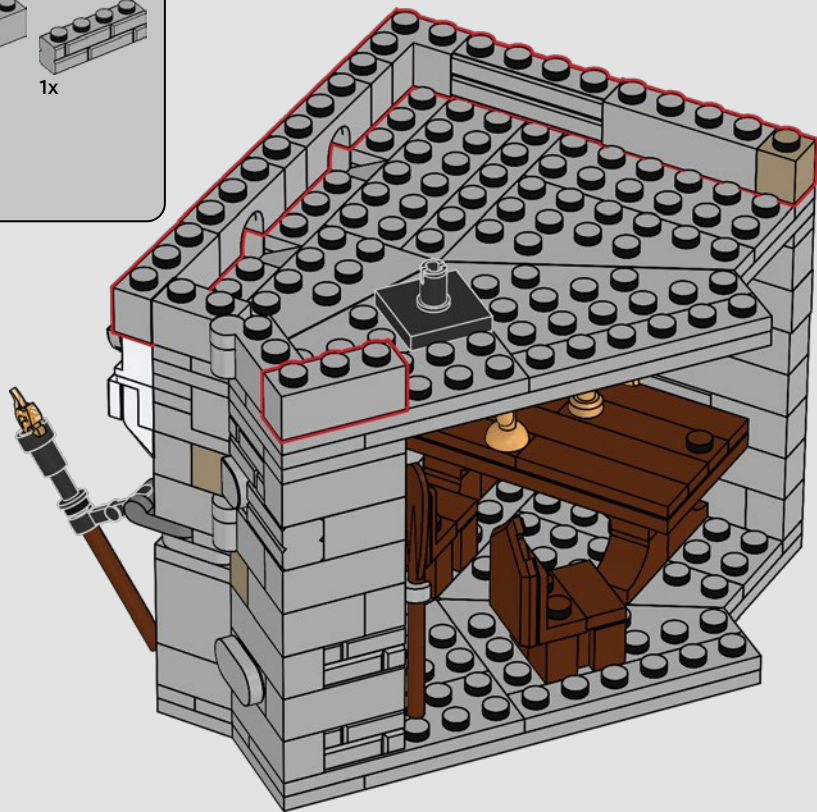



3x

979

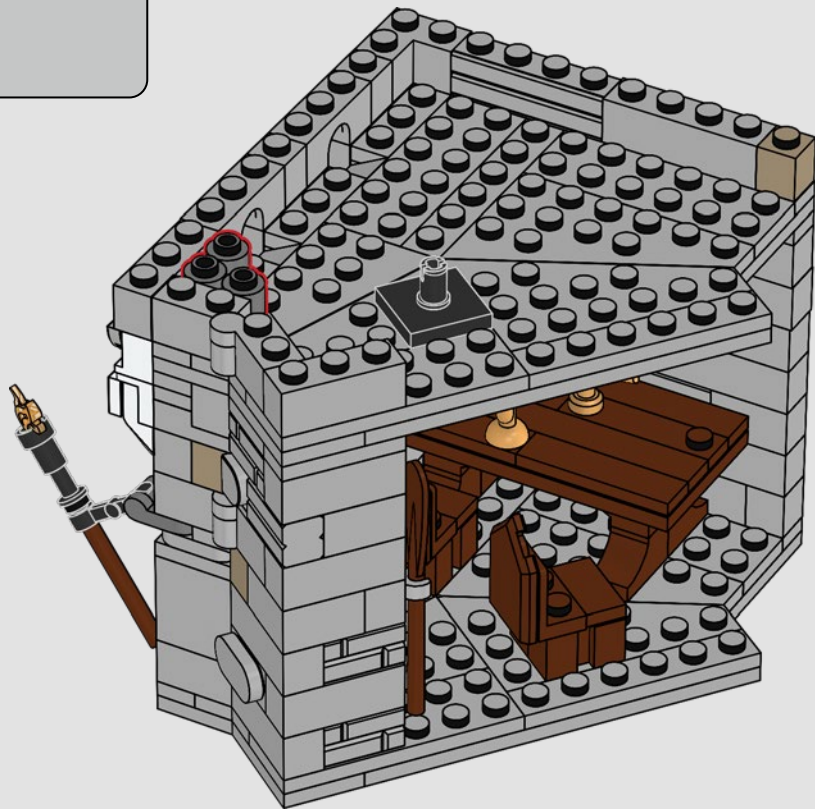

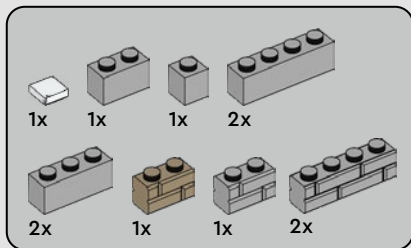

980

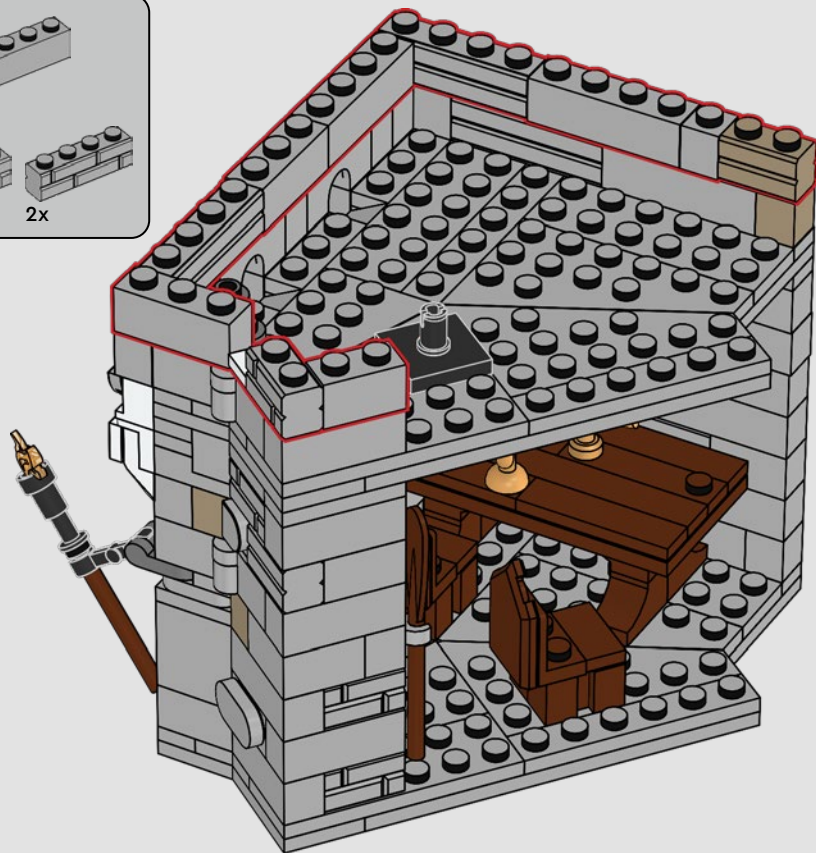



5x



1x

981

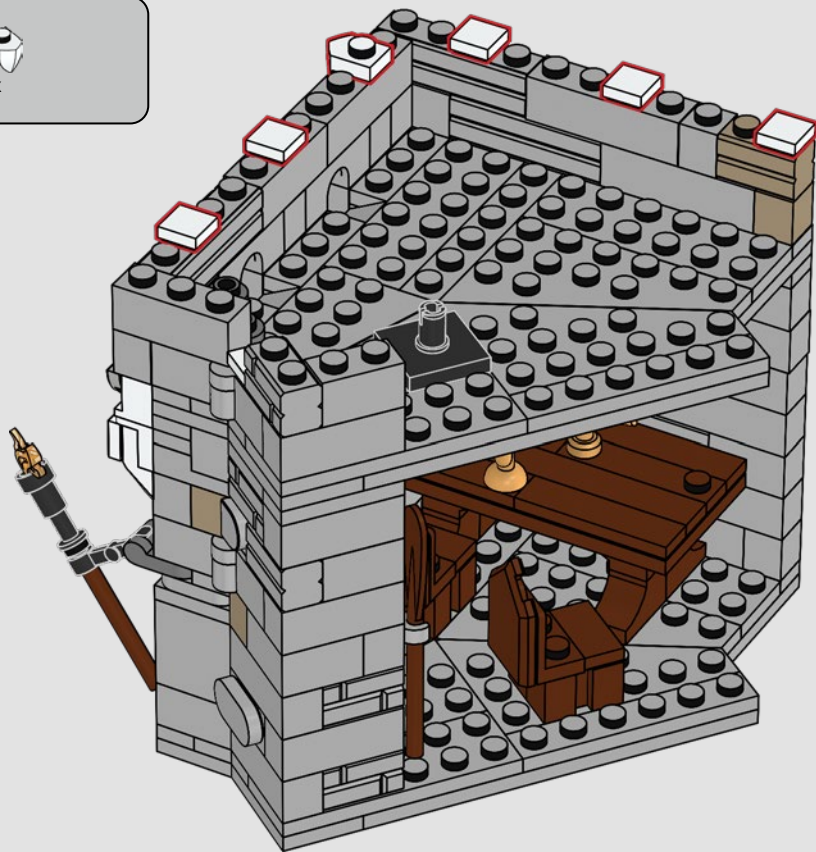

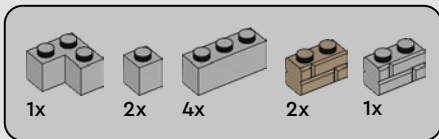

982

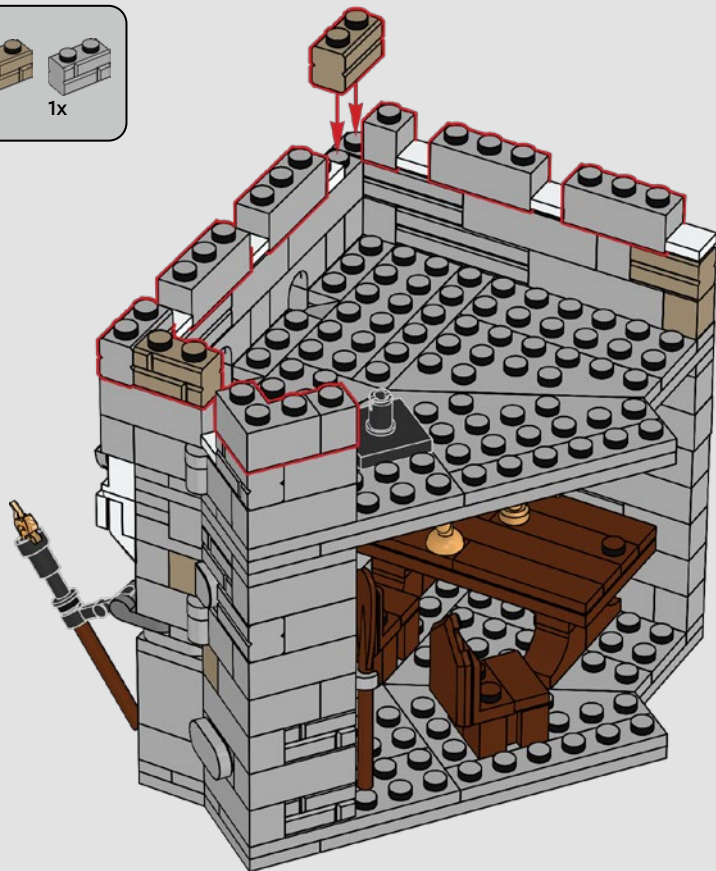

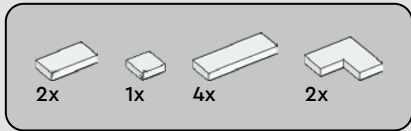

983

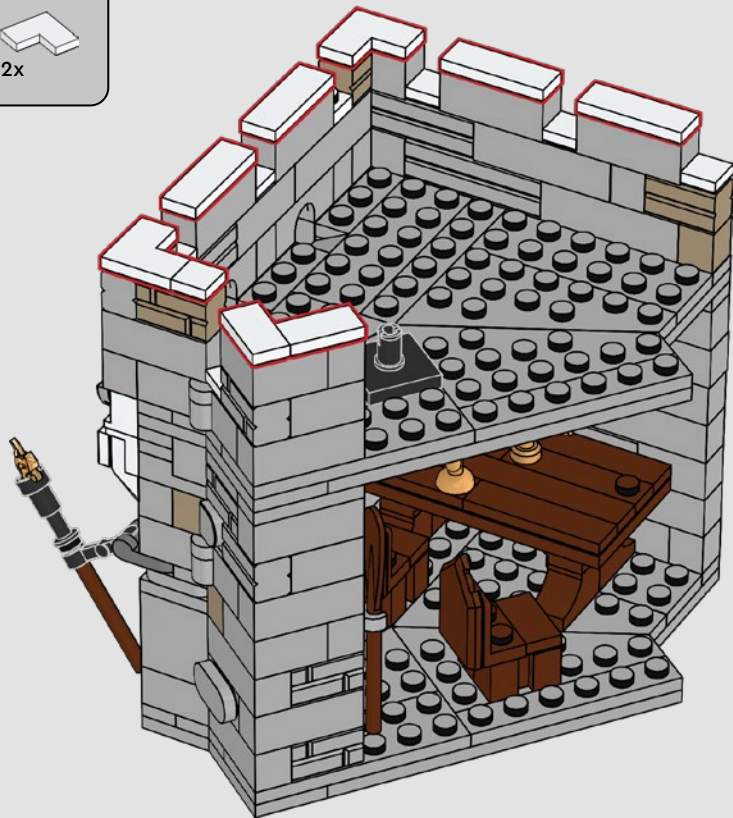

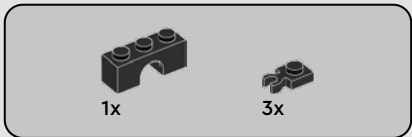

984

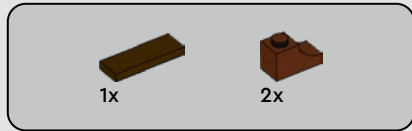
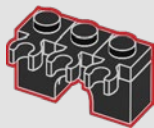

985



986



987

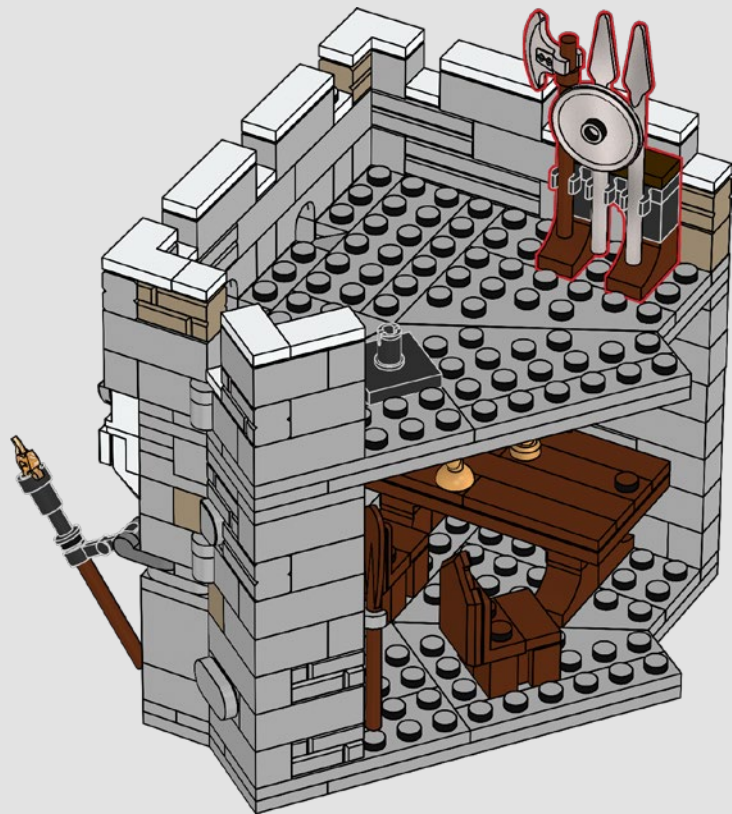

868

988

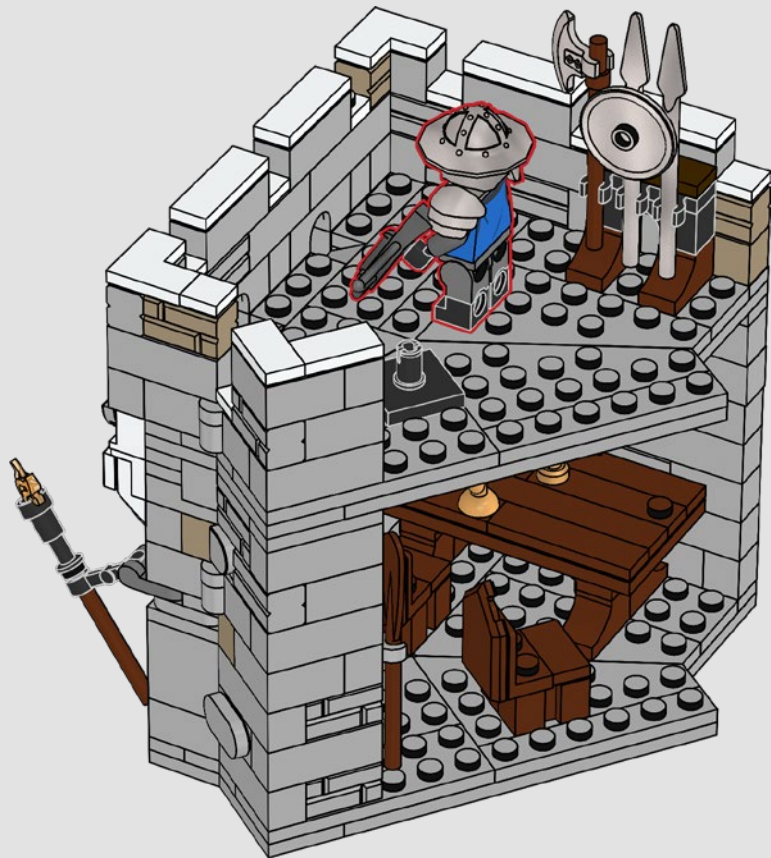

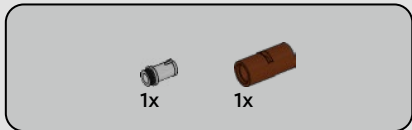

989

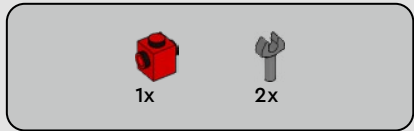

990

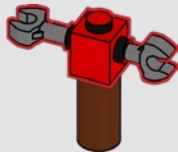



1x



1x

991



1x



1x

992



993

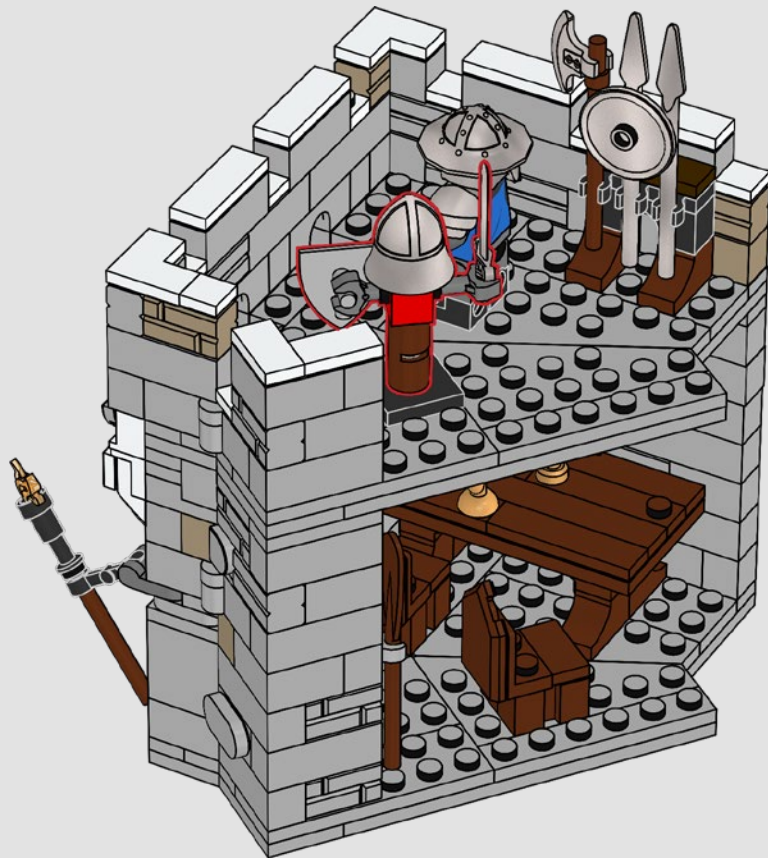

872

994



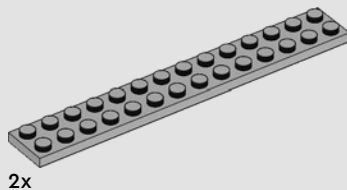
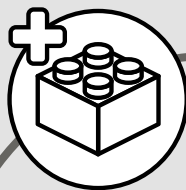

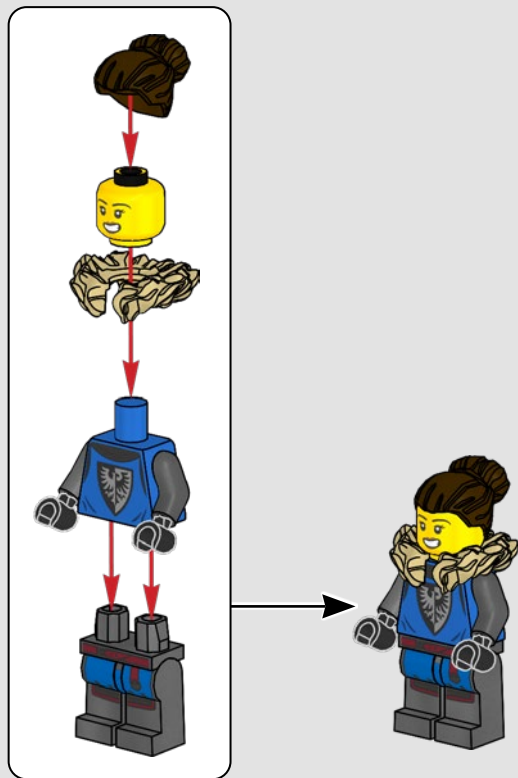

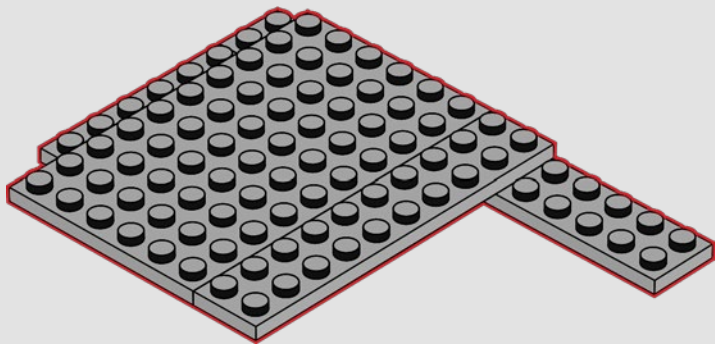
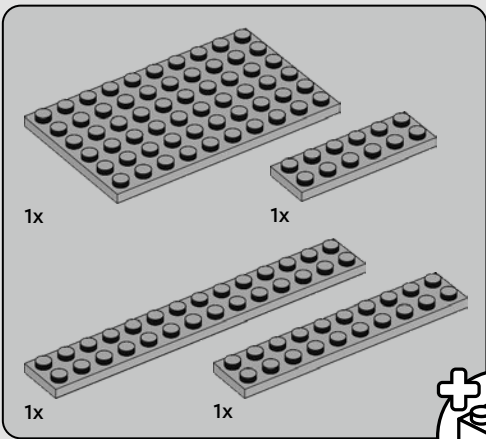
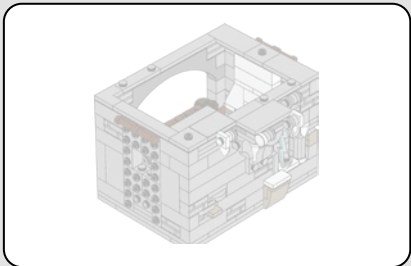

995

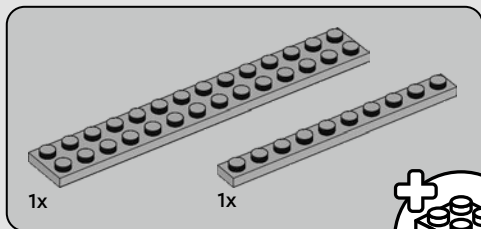

996

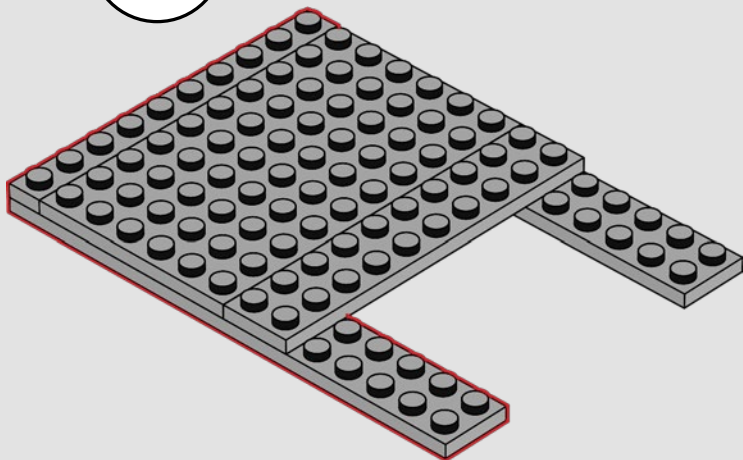

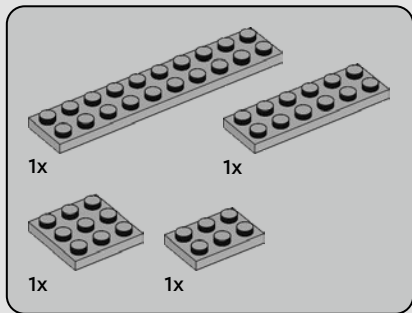

997

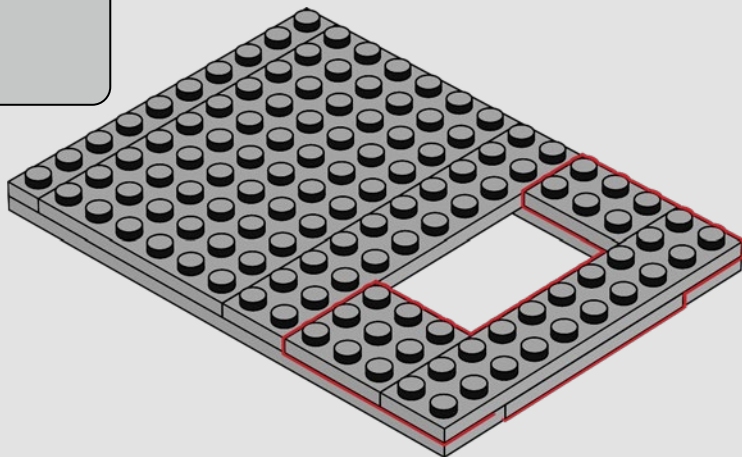

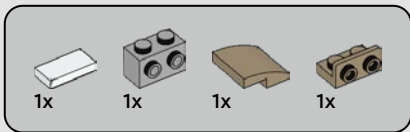

998

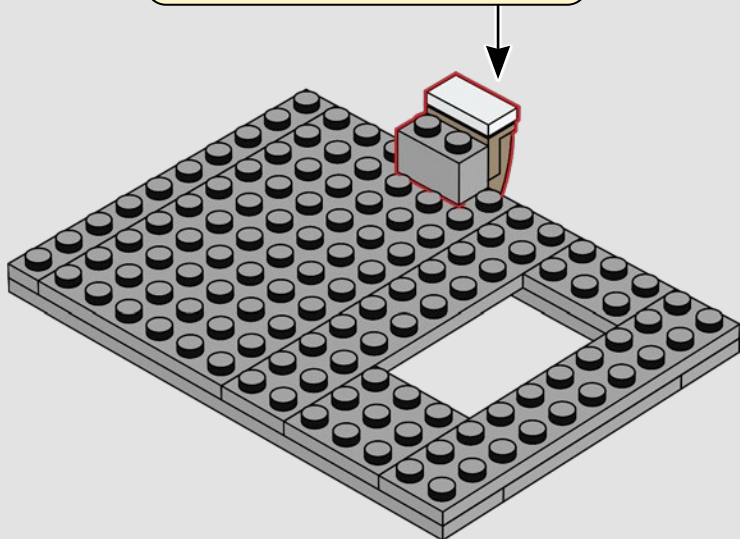
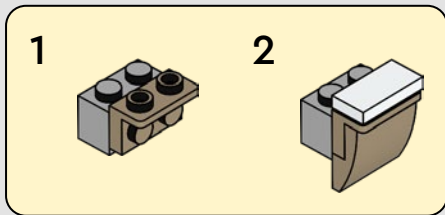

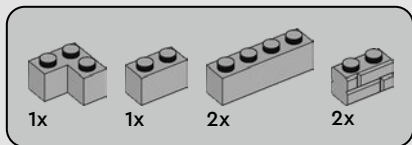

999

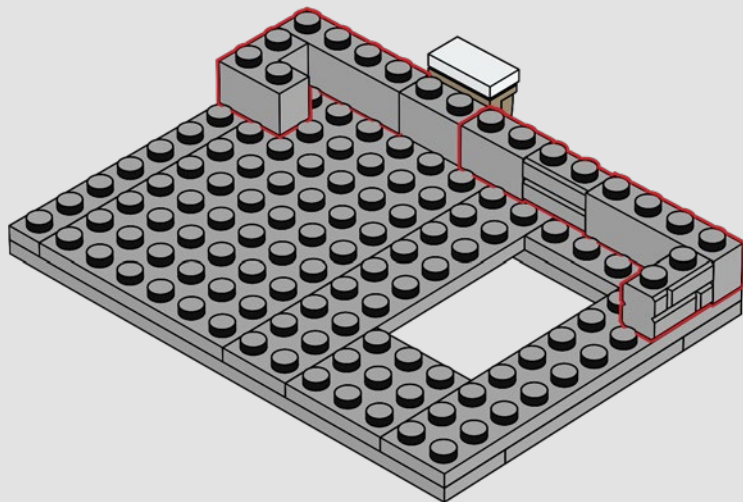



2x



1x

1000

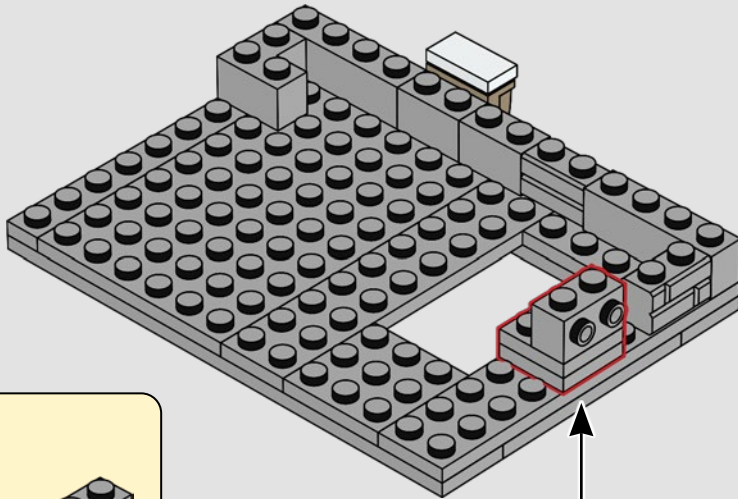

1

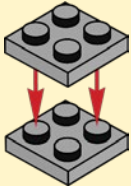

2

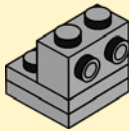



1x



1x



1x

1001

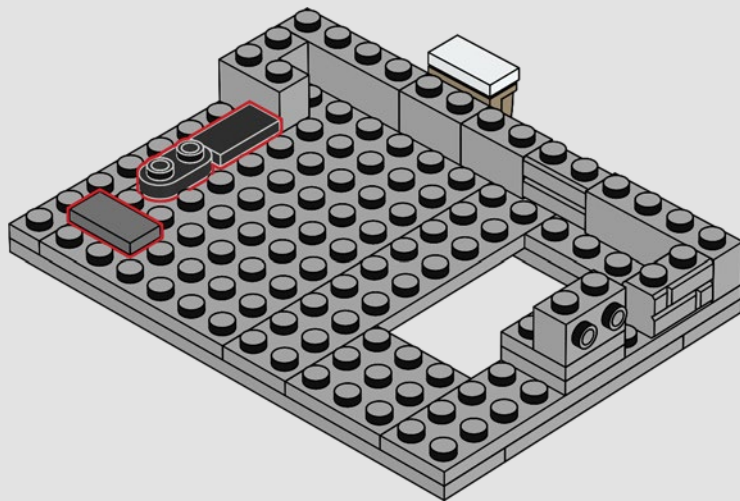

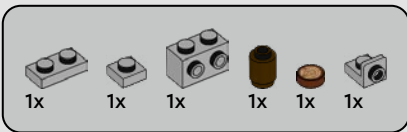

1002

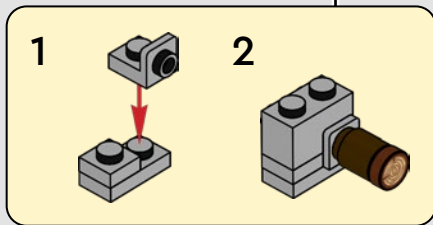

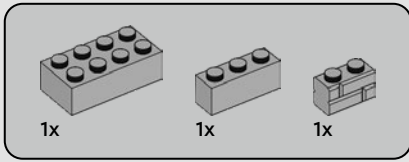

1004

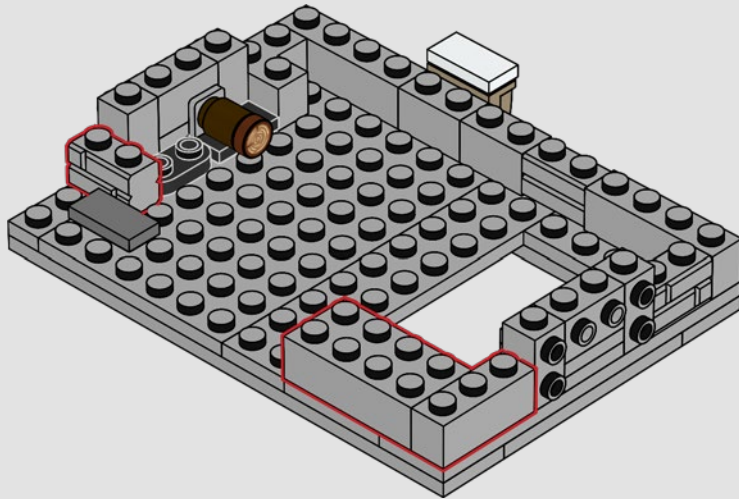

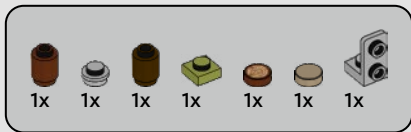

1005

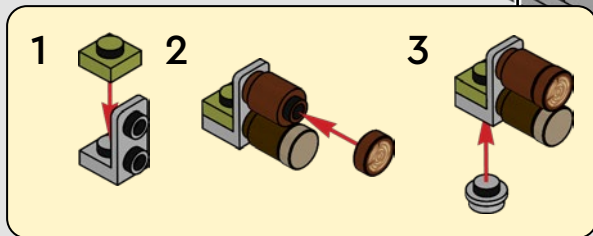

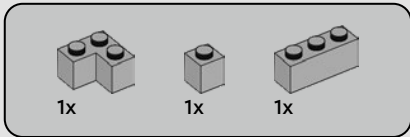

1006

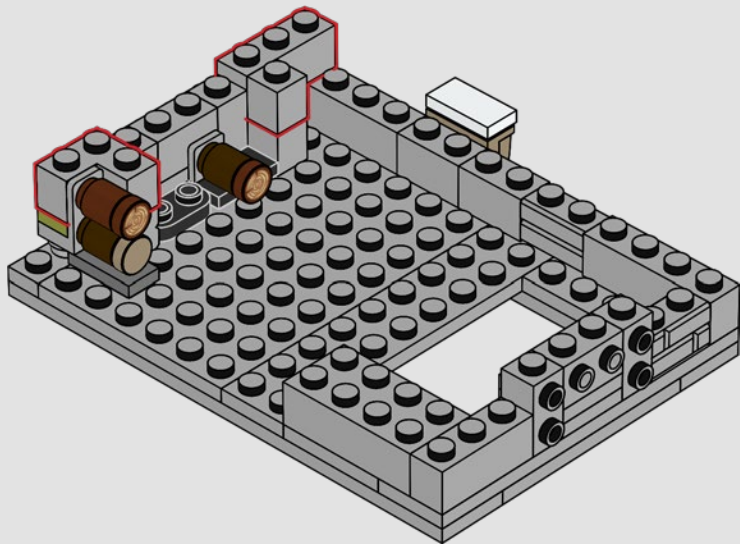



1x



1x

1007



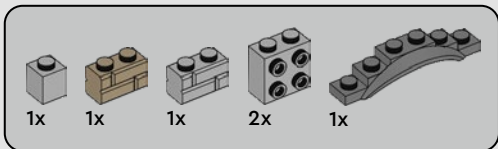

1008

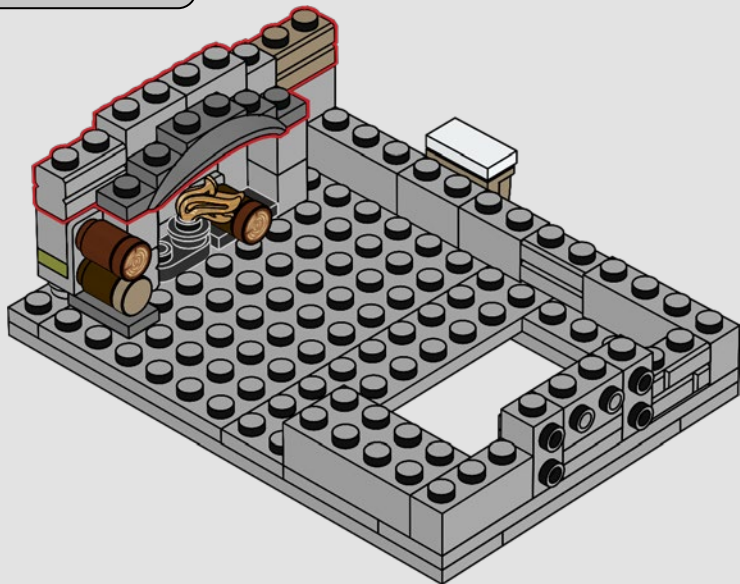



1x



1x

1009

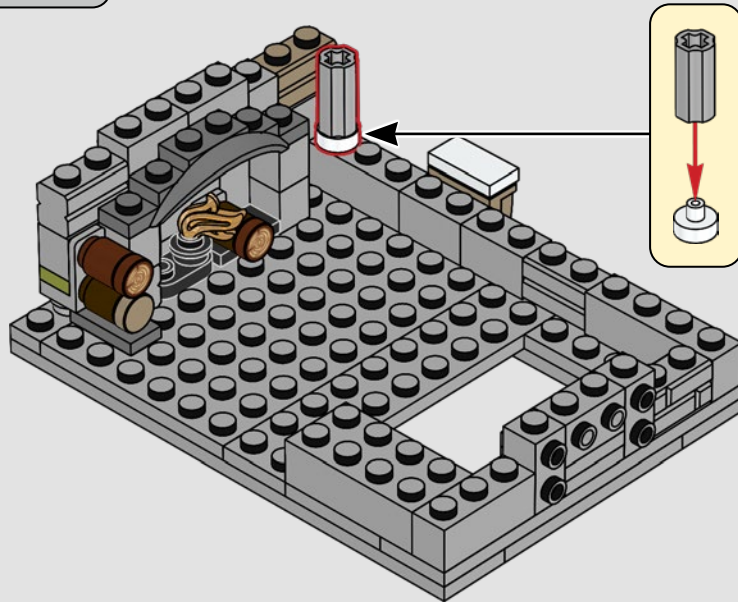

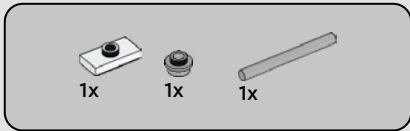

1010

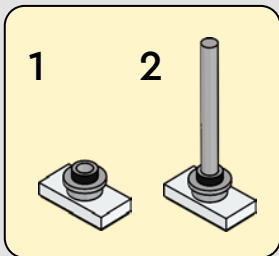
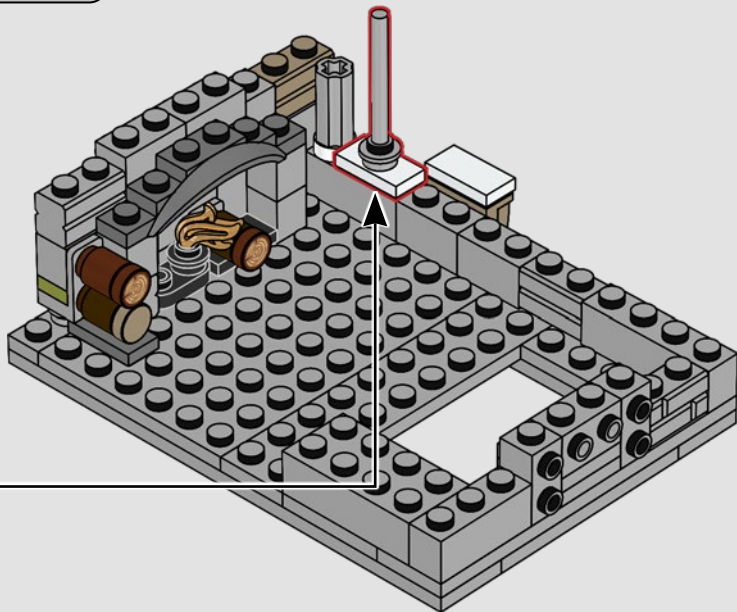



1x



1x

1011

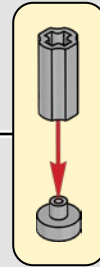
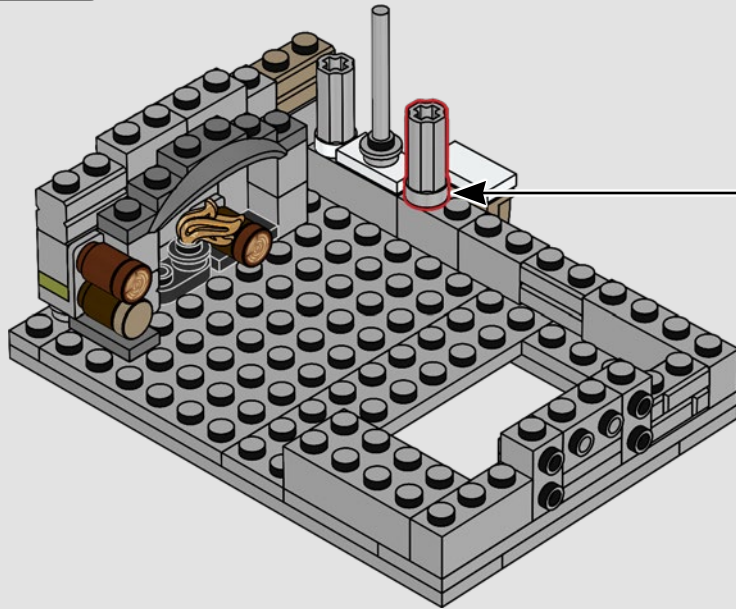

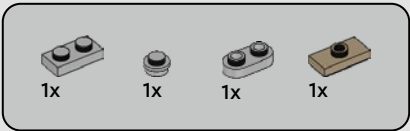

1012

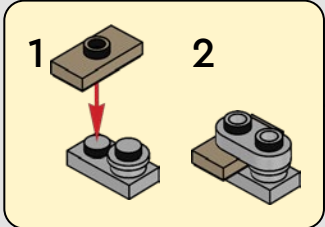
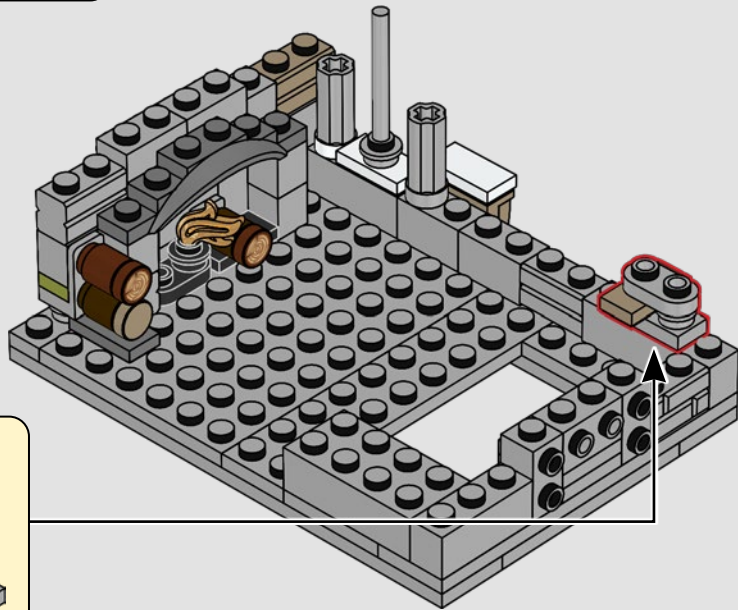

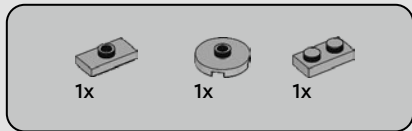

1015

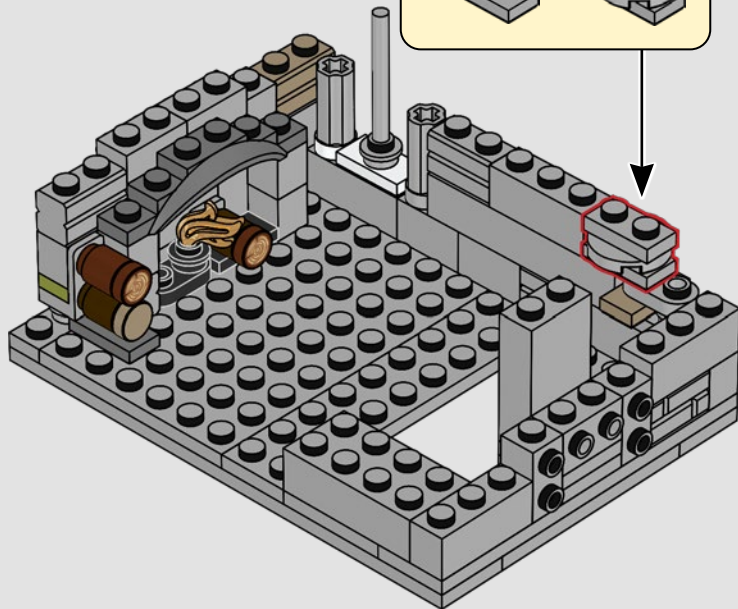
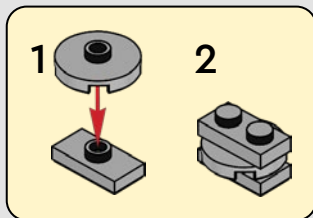



1x



2x

1016

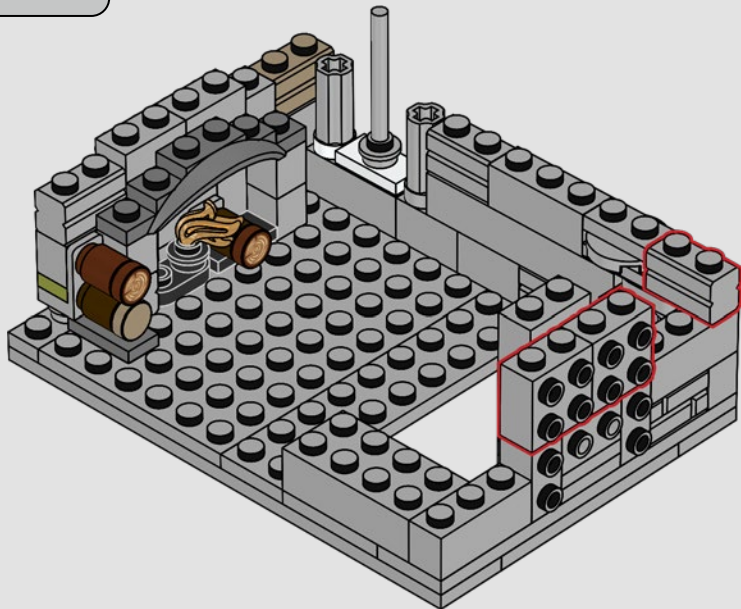

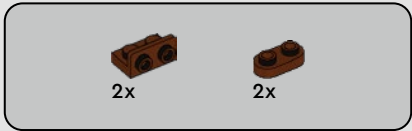
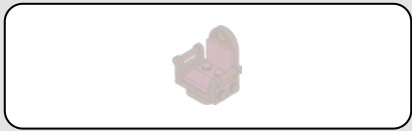

1018

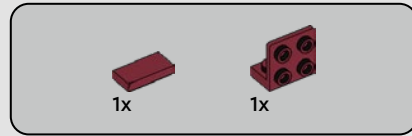

1019



1020

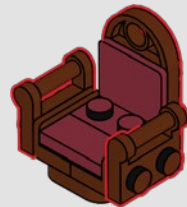

1021

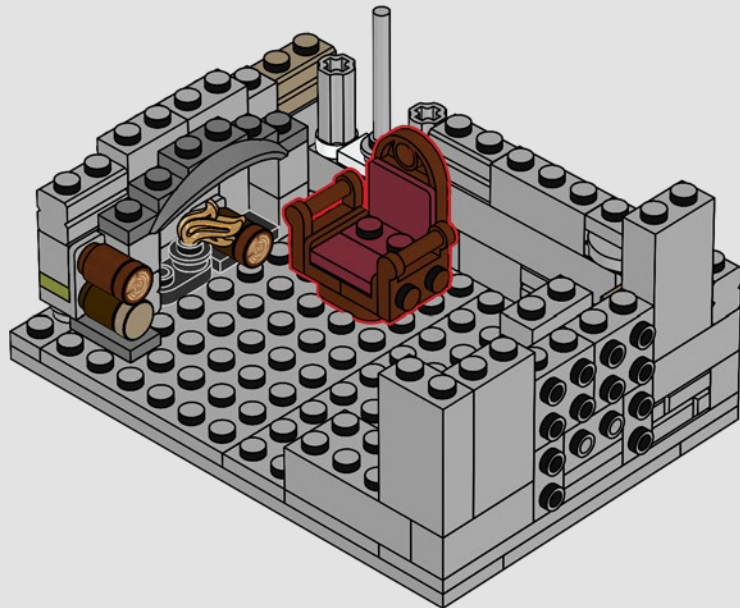

1022

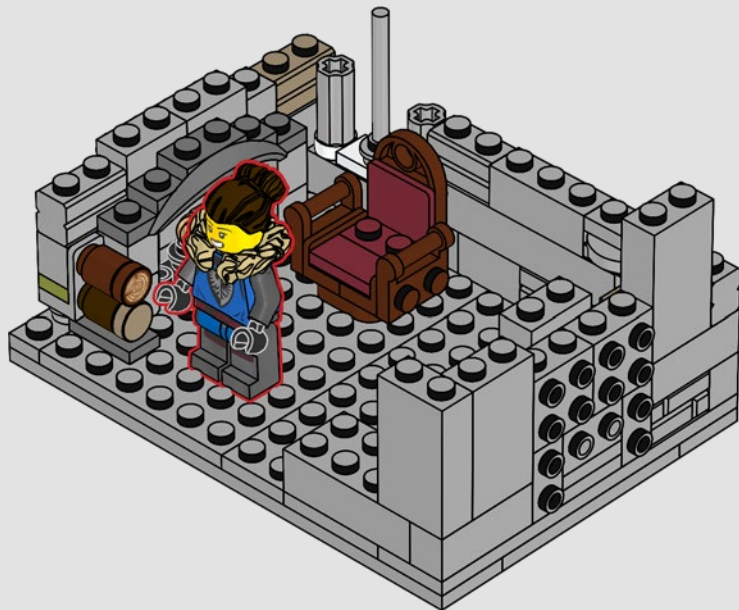



2x



2x

1023





1x



1x

1024

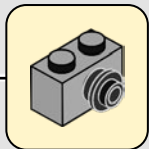
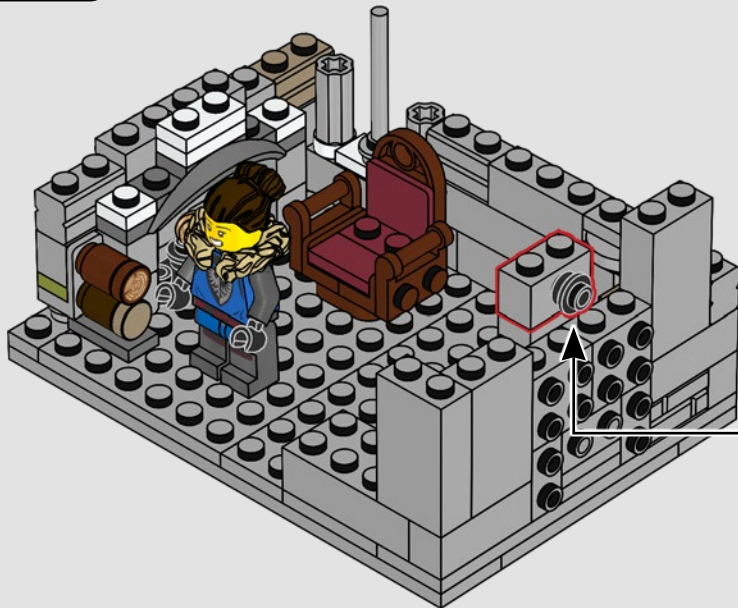

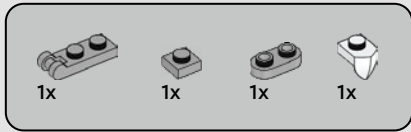

1025

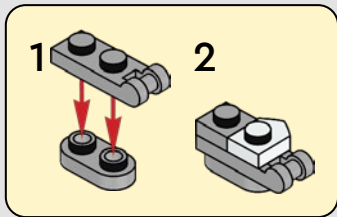

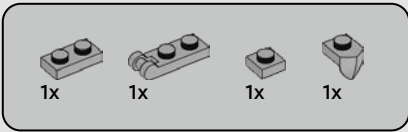

1026

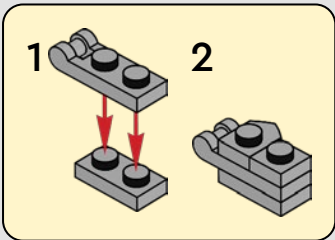

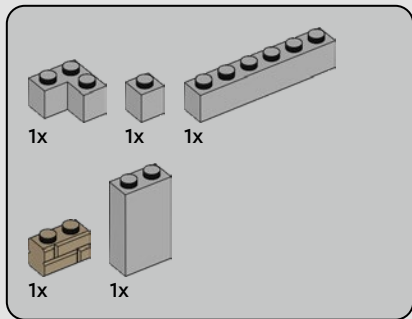

1027

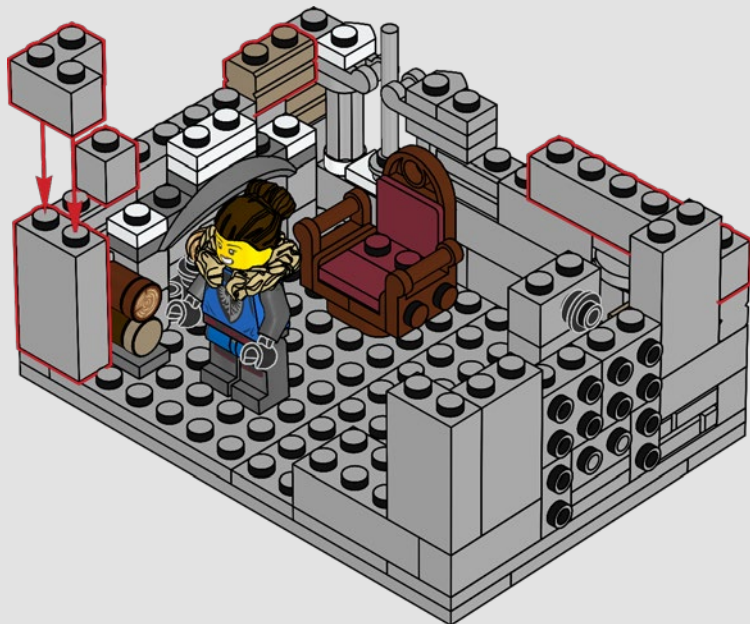

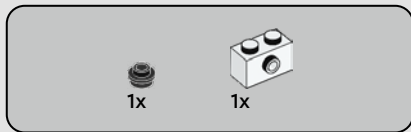

1028

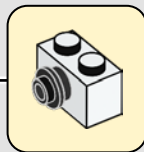



2x



2x

1029



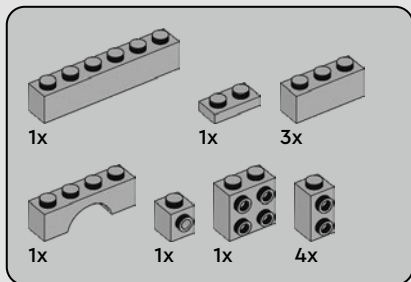

1030

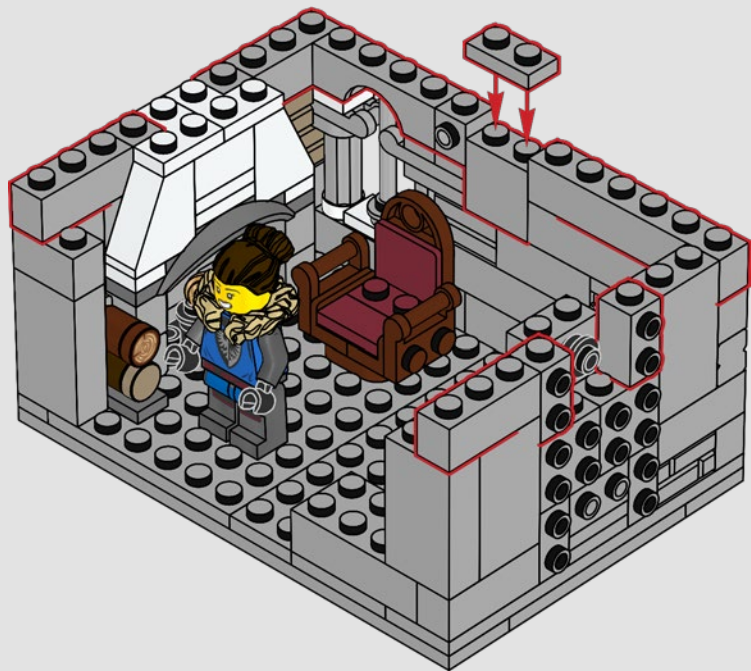





2x



2x

1031

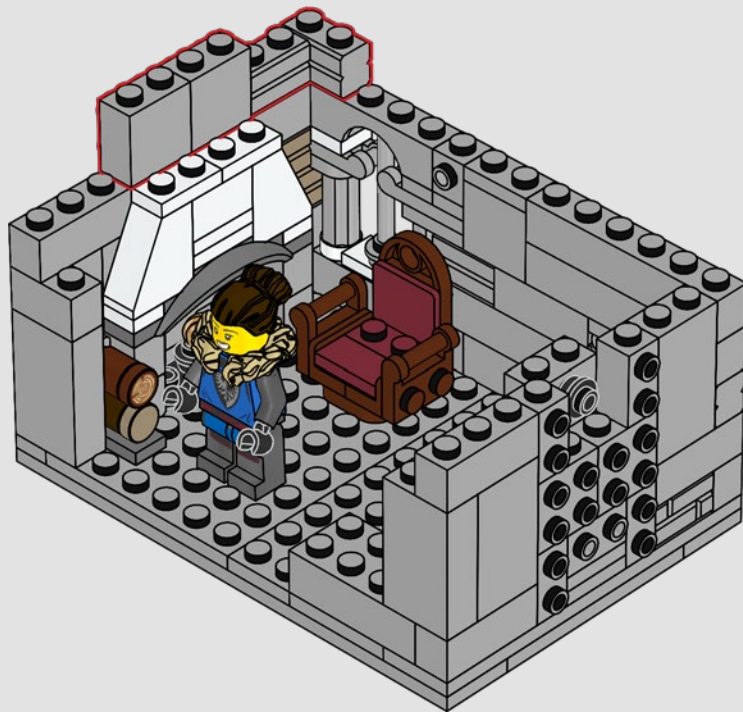



1x



1x

1032

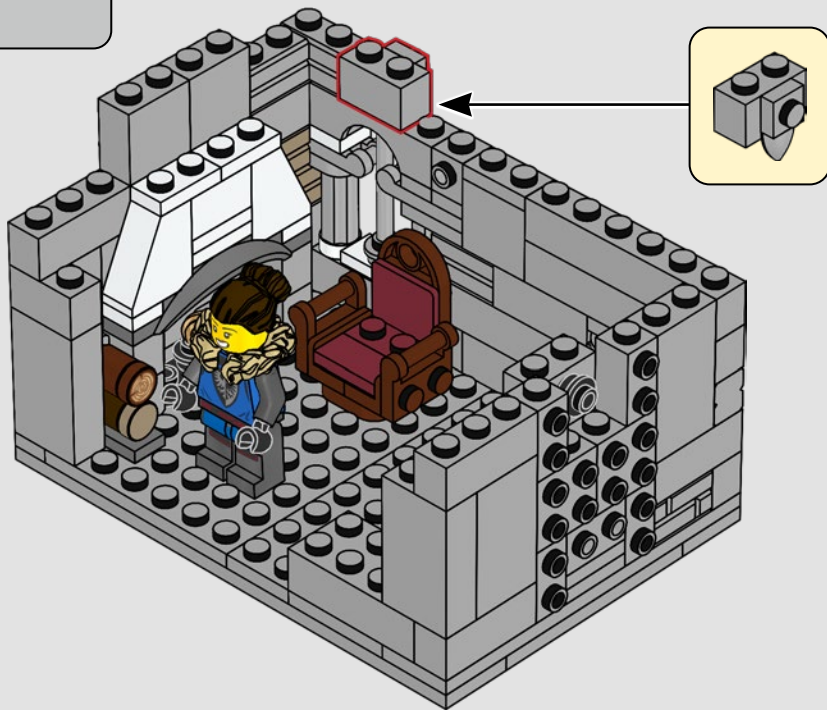

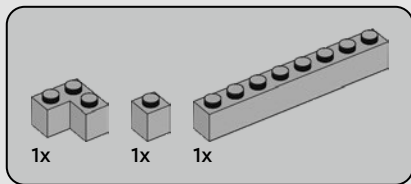

1033

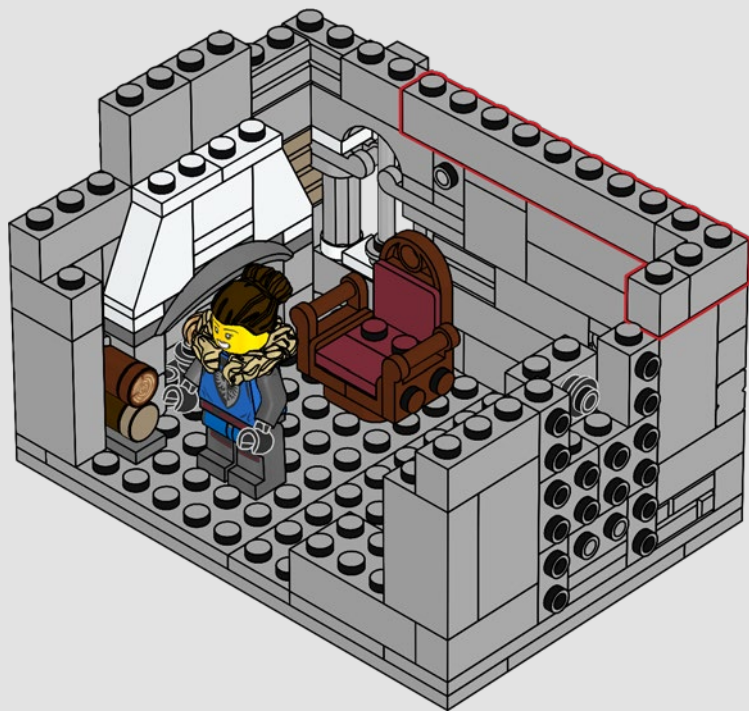

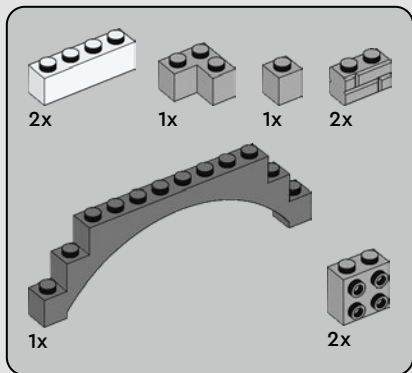

1034

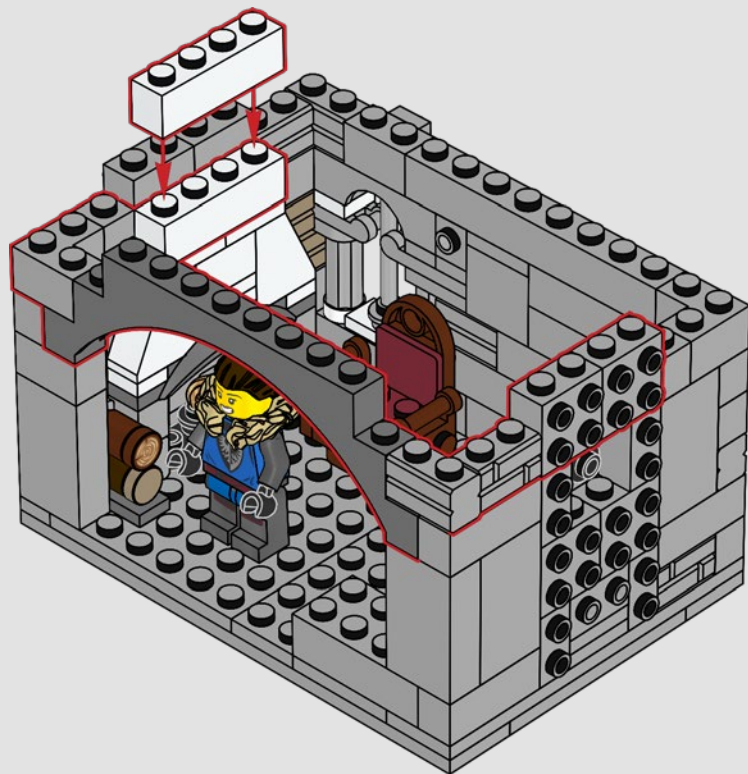

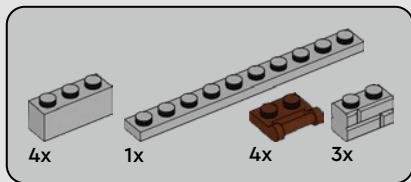

1035

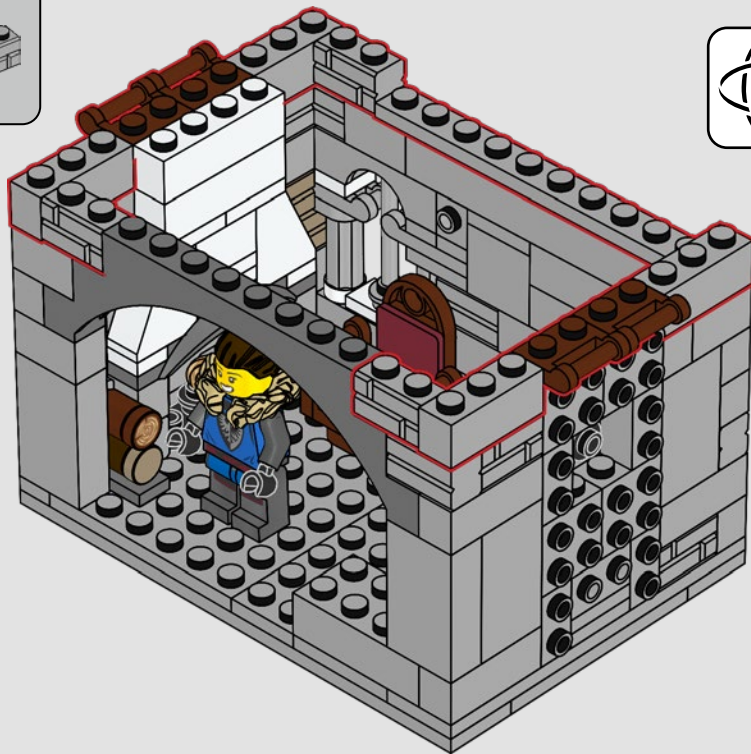



2x



2x



1x

1036



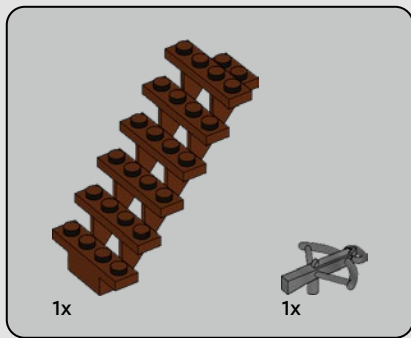

1037

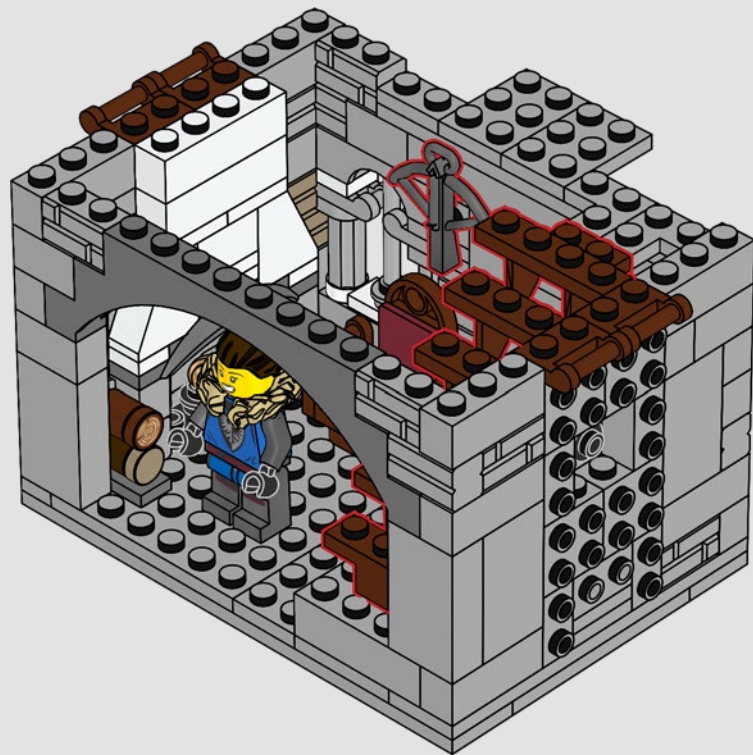

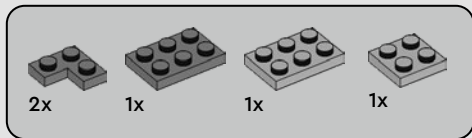

1038

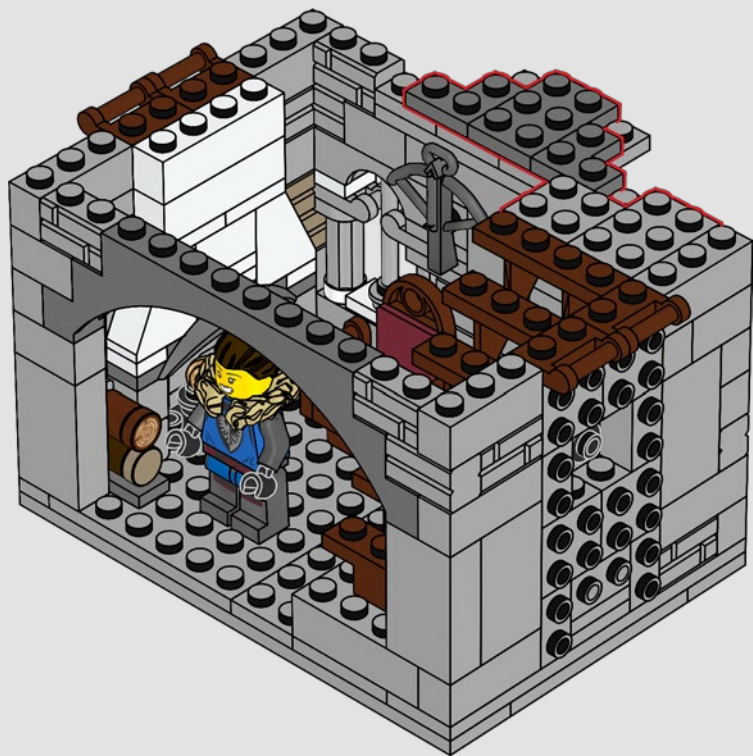



1x



2x

1039

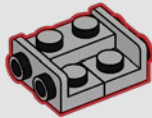

1x



2x

1040

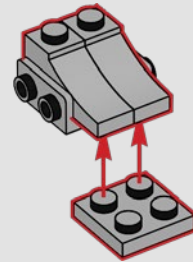



2x

1041

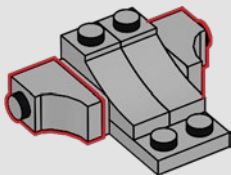

1x



1x

1042

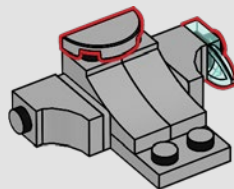

1043

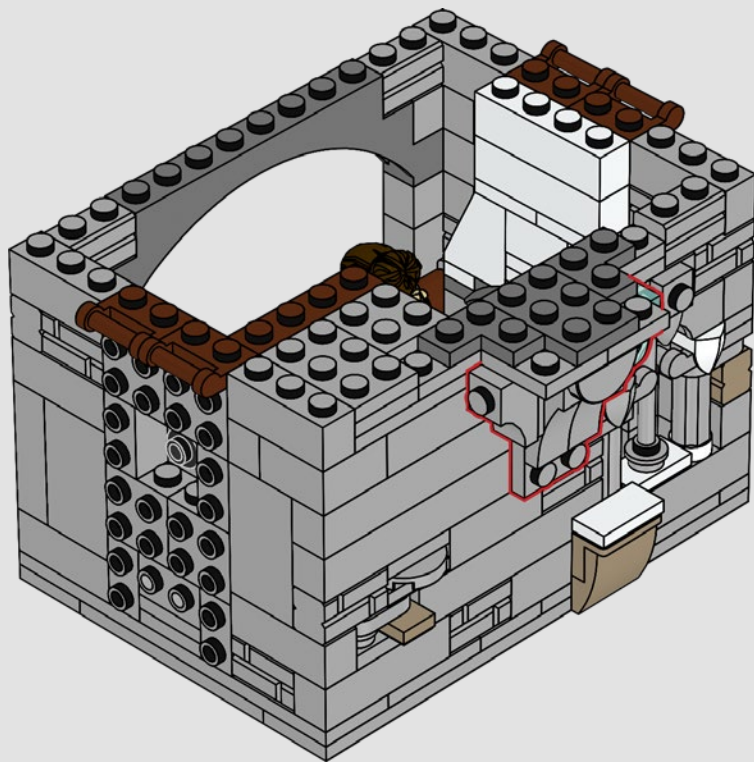

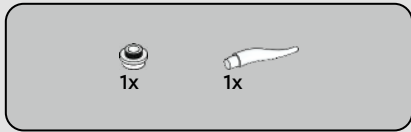

1044

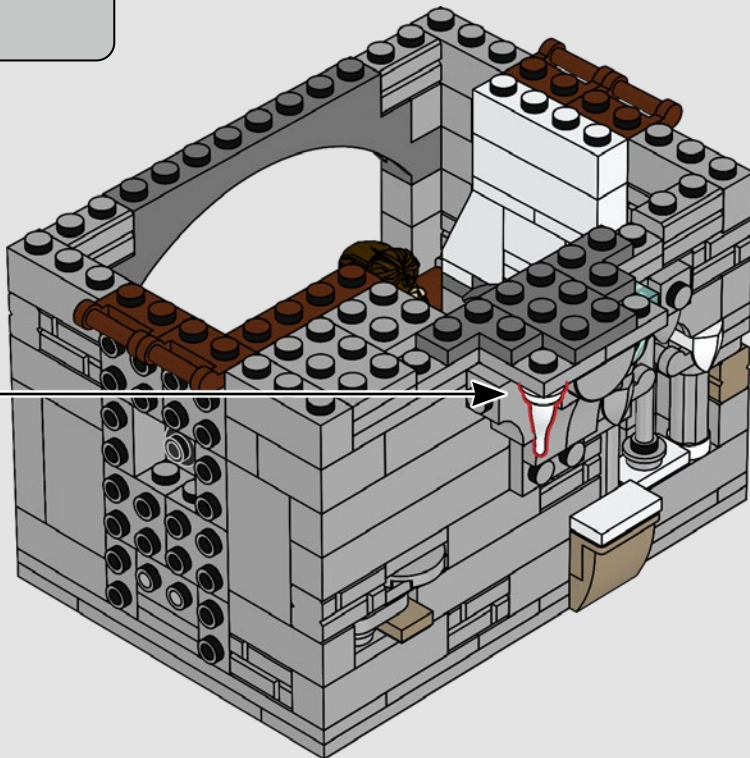
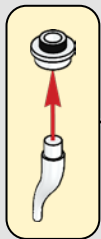



1045

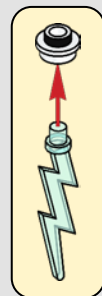
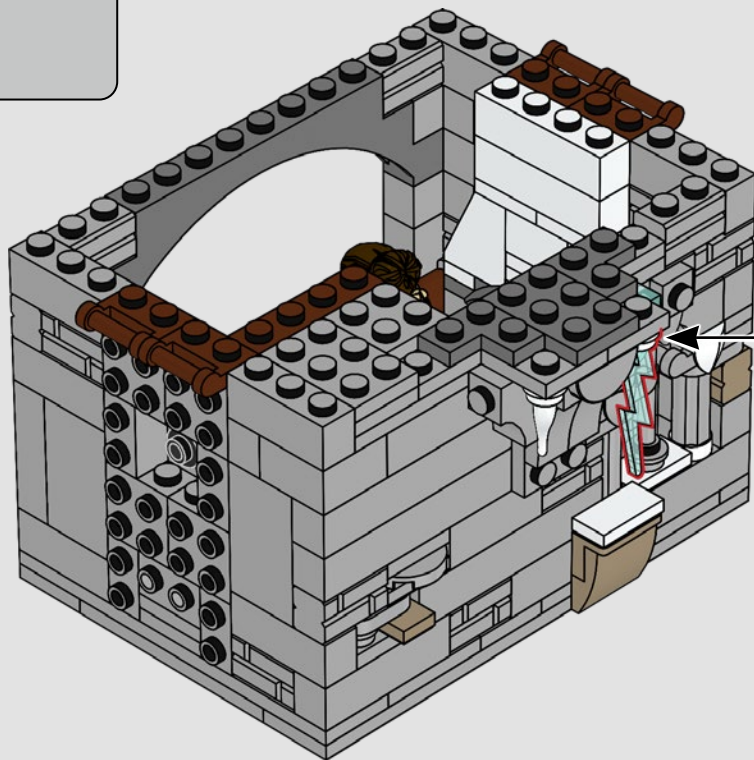

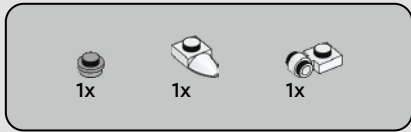

1046

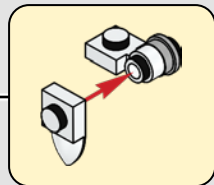
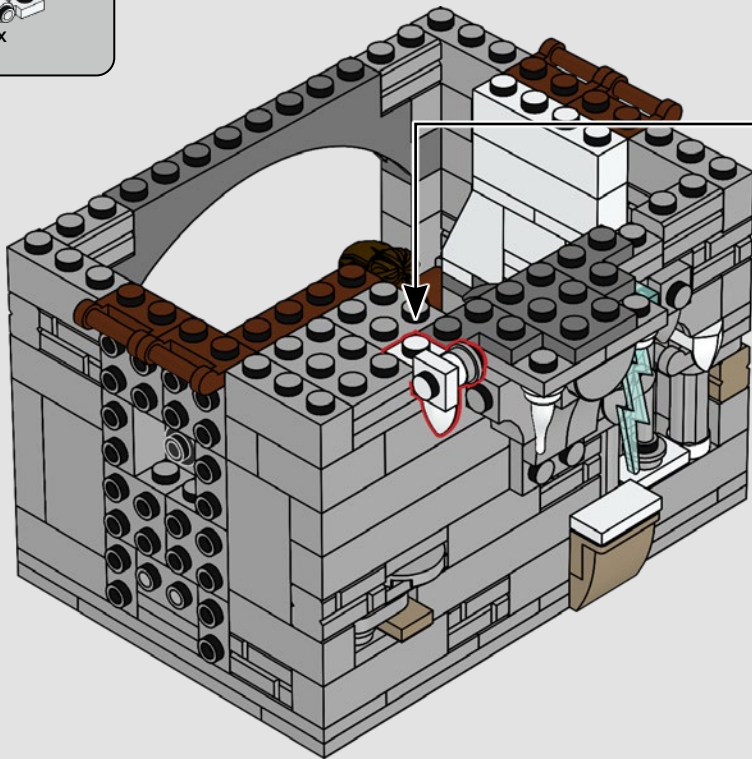



1x



1x



1x

1047

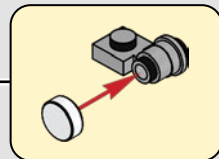
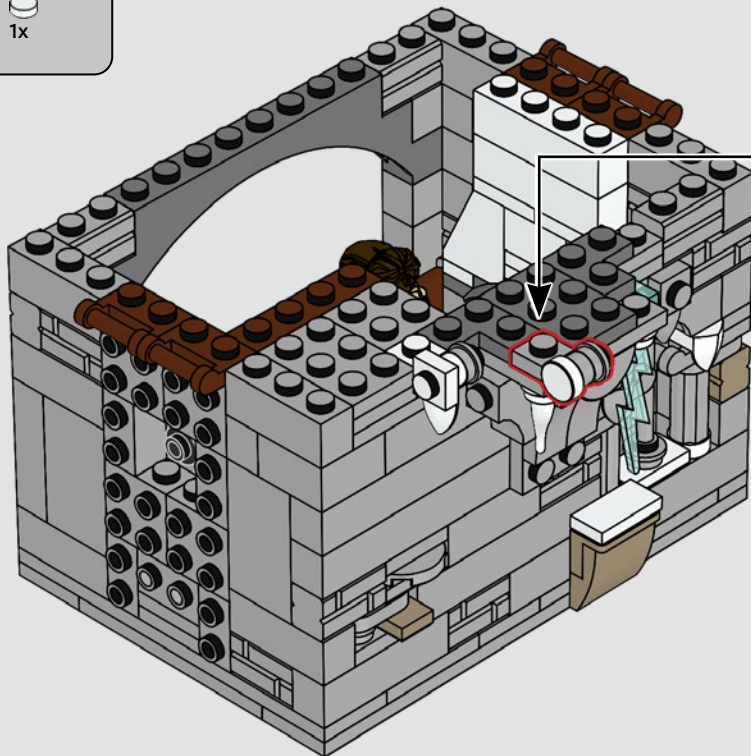

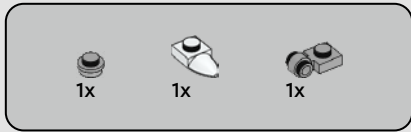

1048

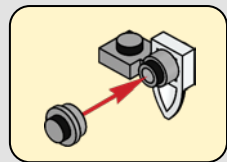
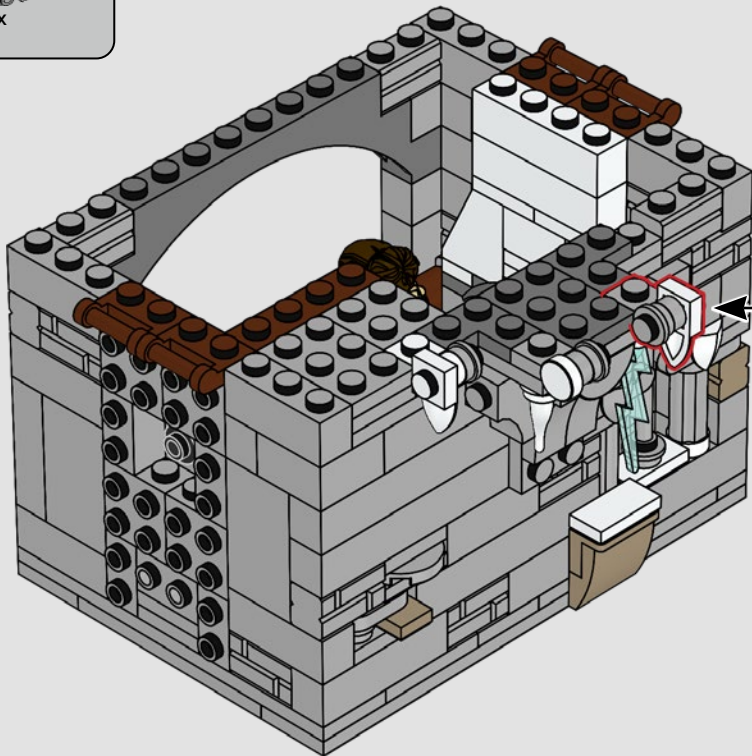



2x



1x

1049

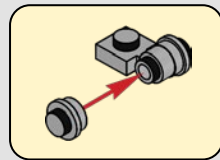
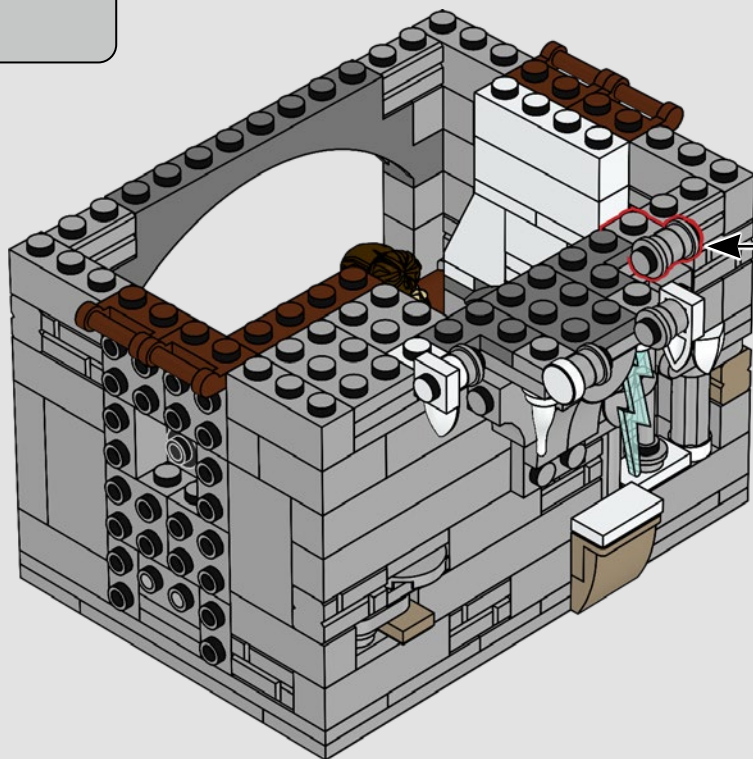

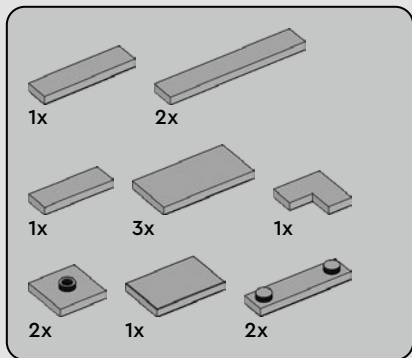

1050

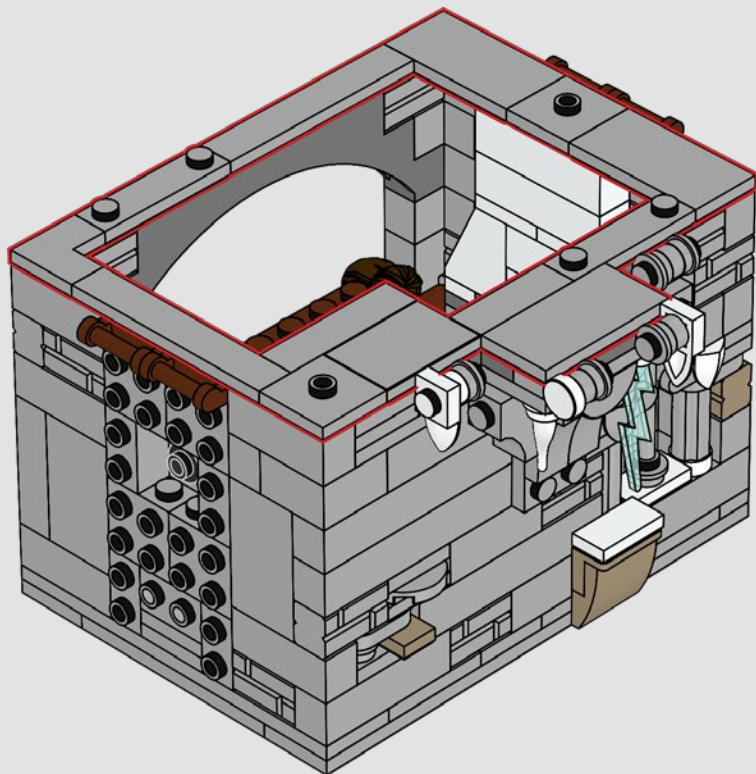

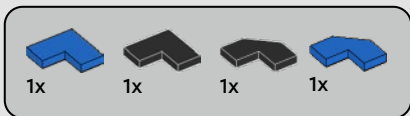

1051

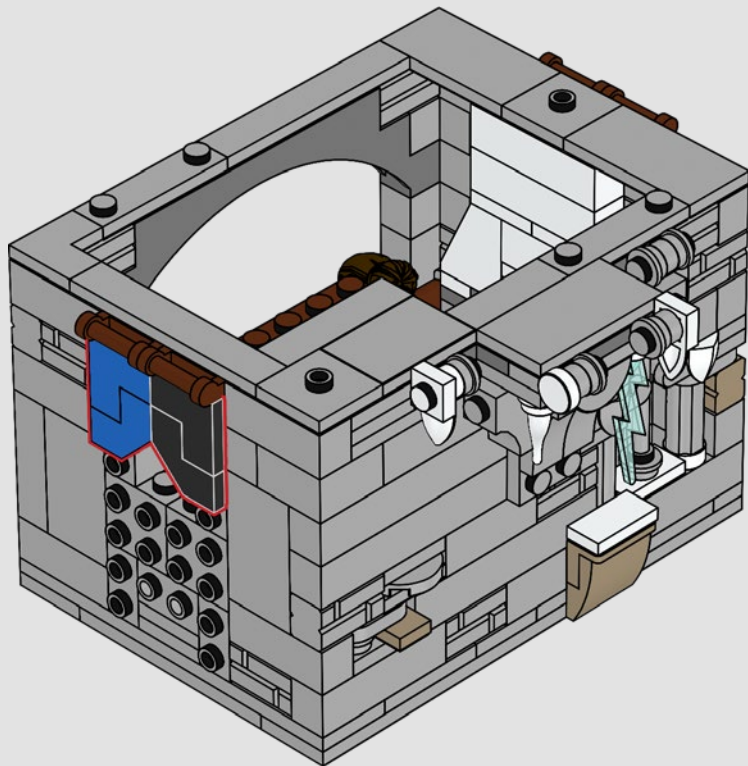

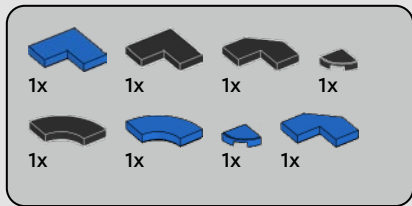

1052

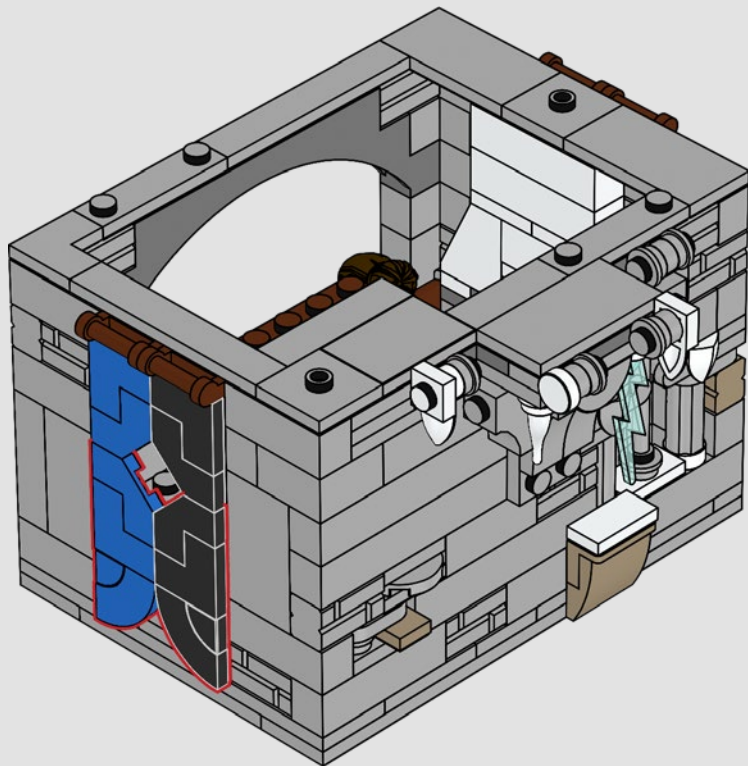



1x

1053

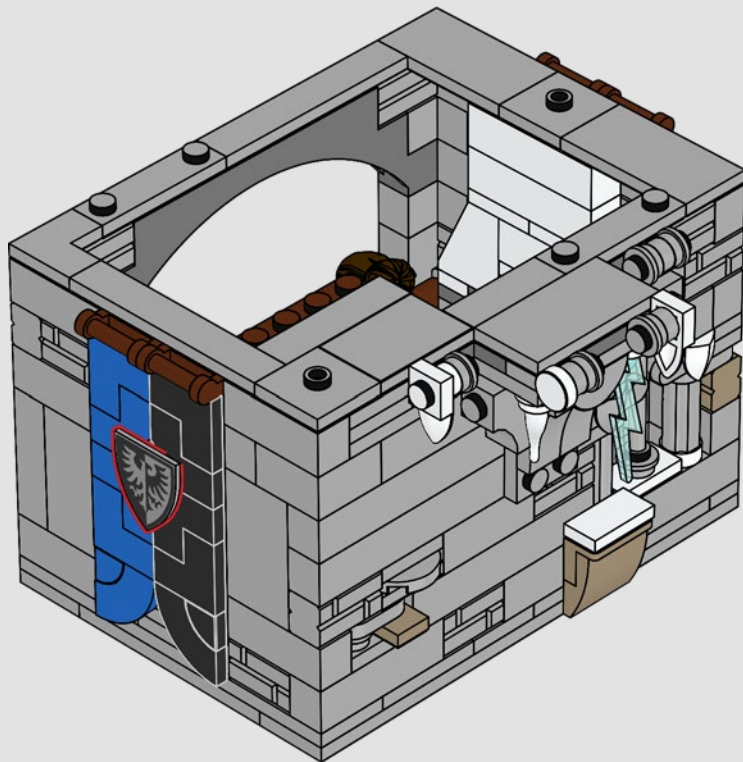

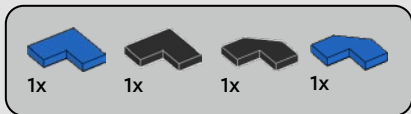

1054

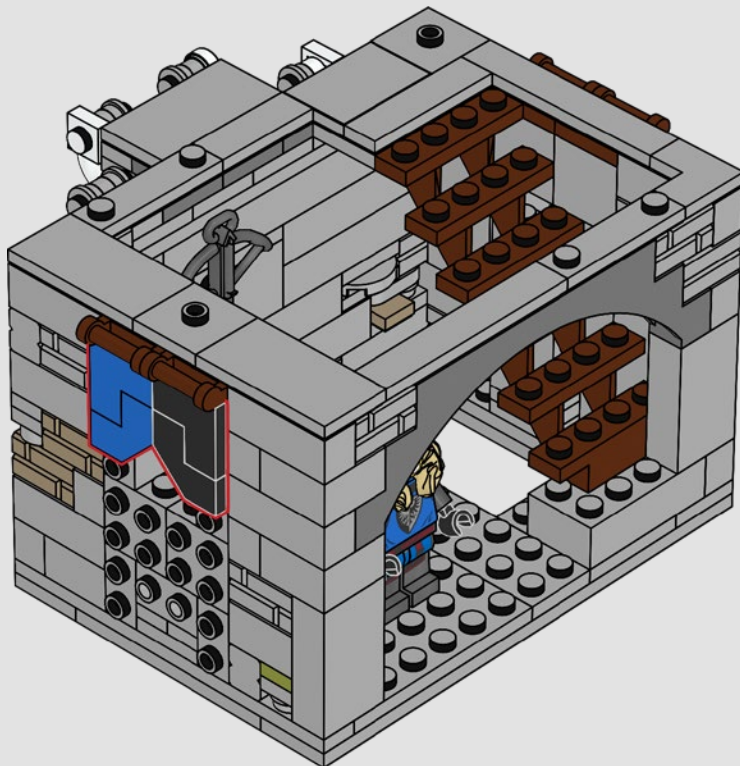
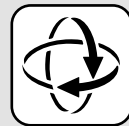

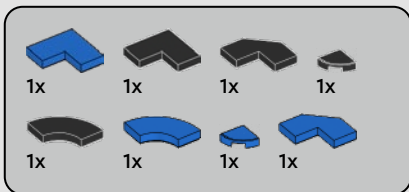

1055

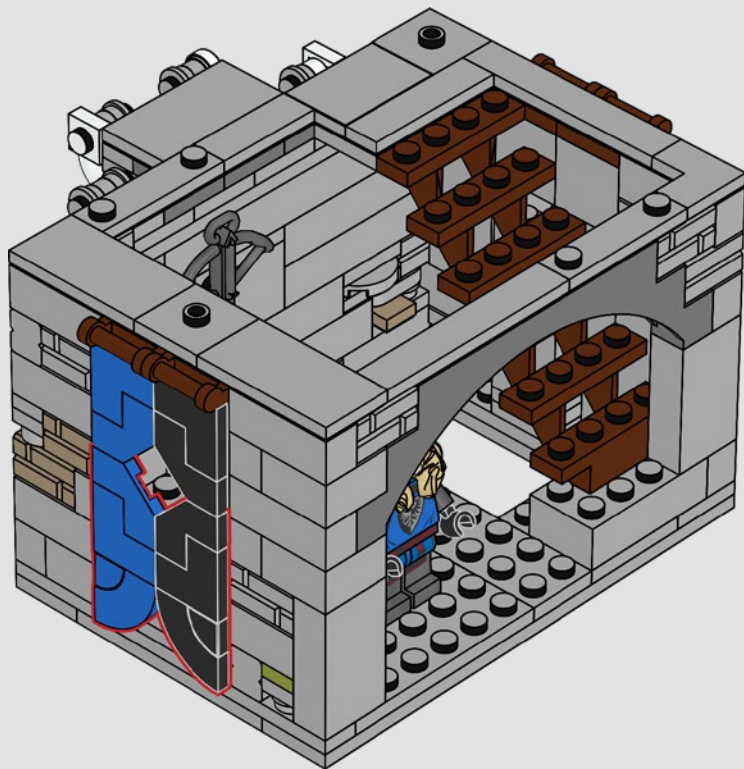



1x

1056

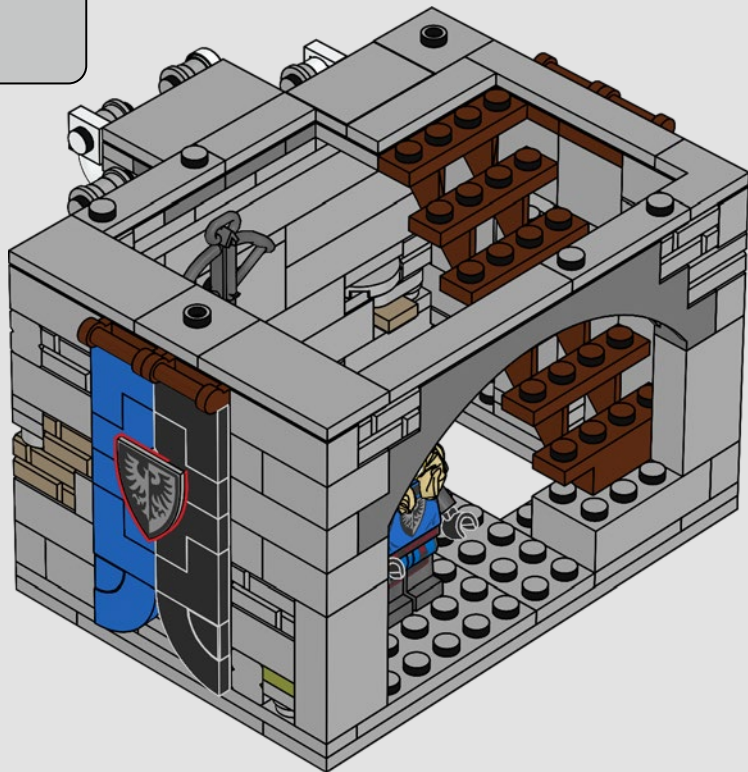

1057





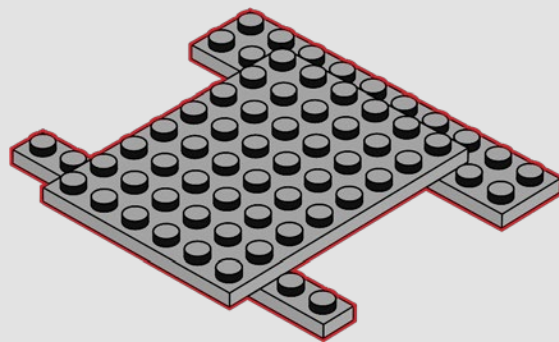
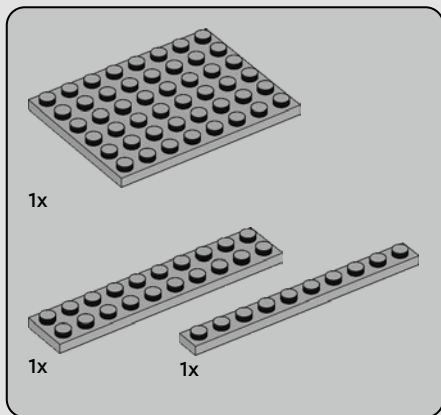
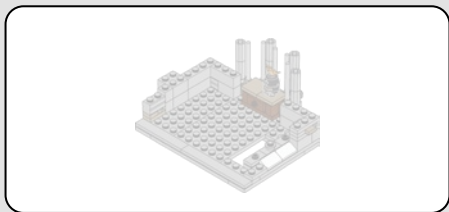

1058

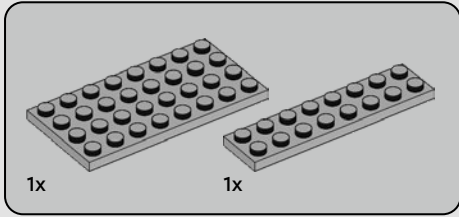

1059

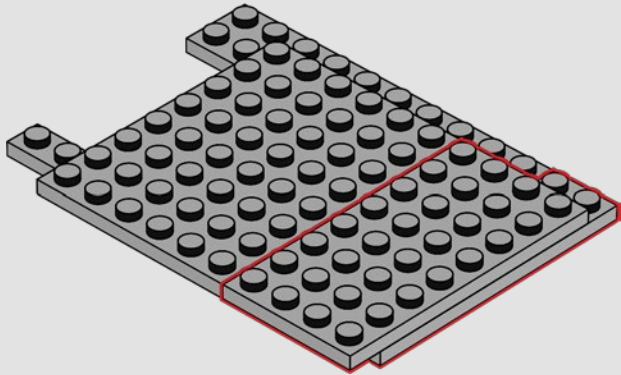

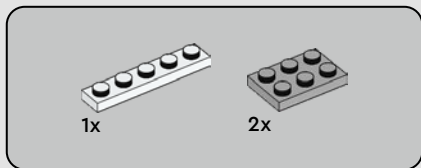

1060

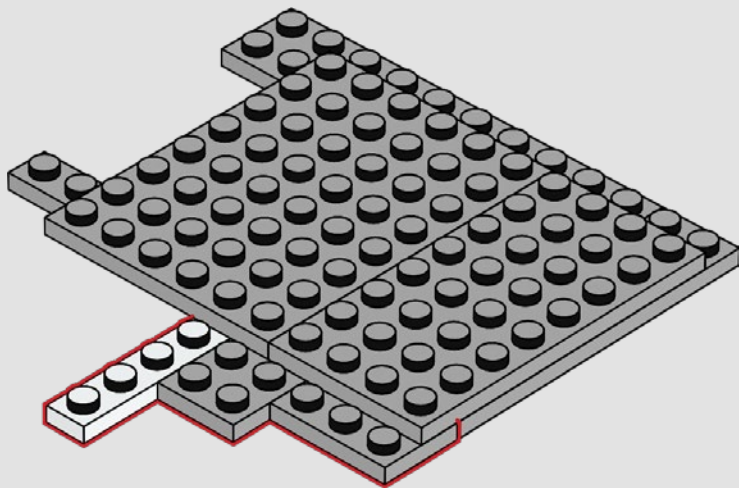

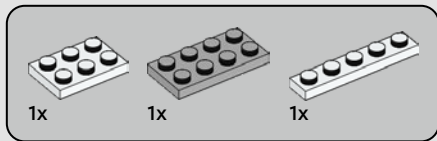

1061

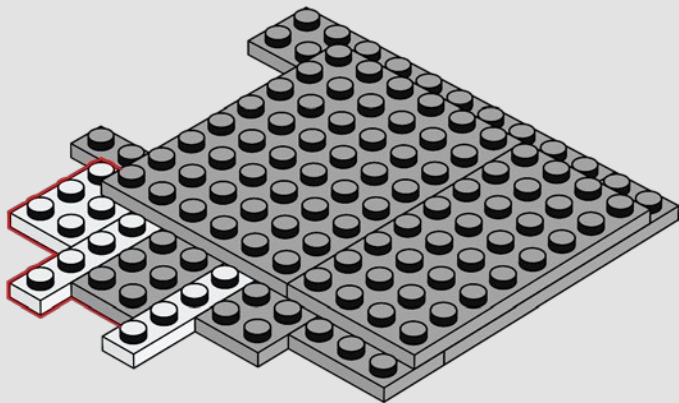

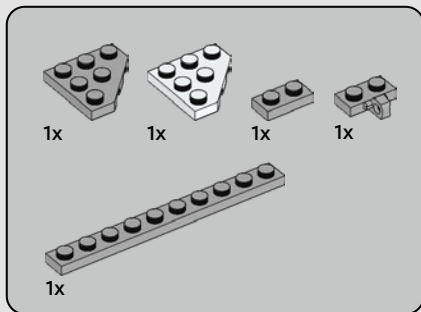

1062

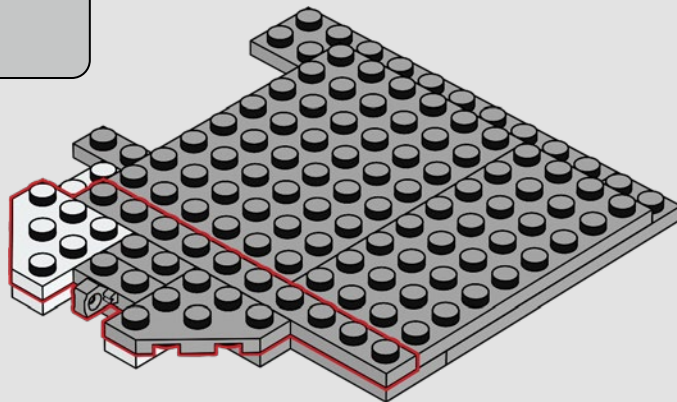

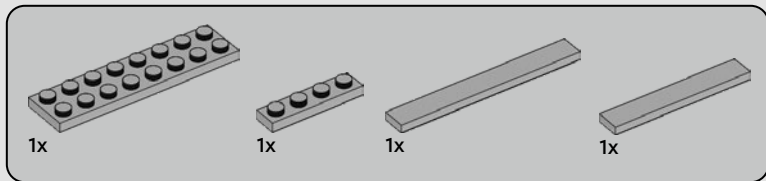

1063

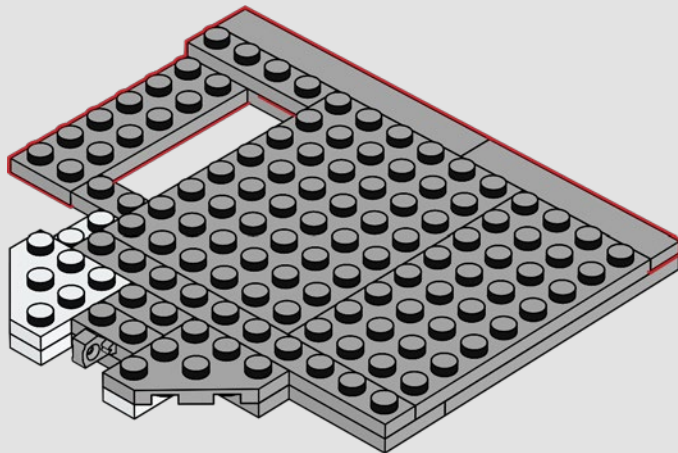

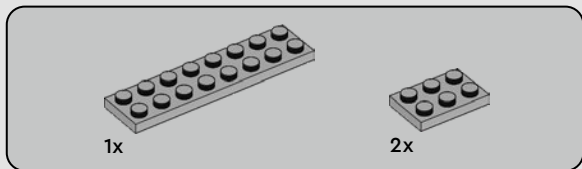

1064

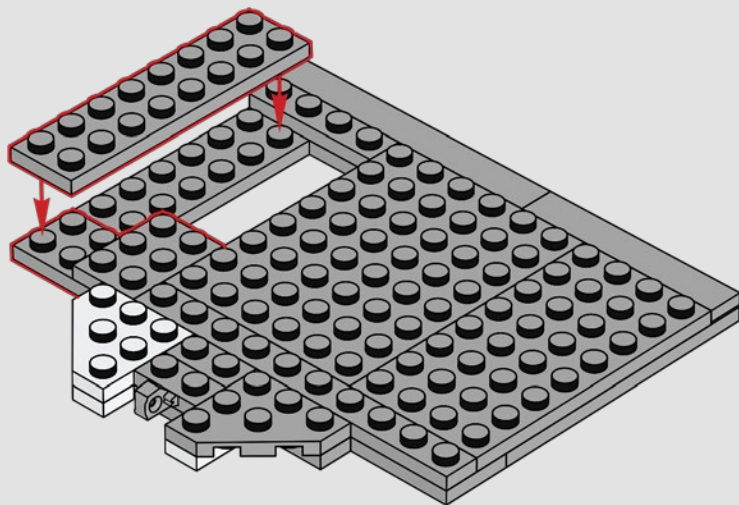



2x

1065

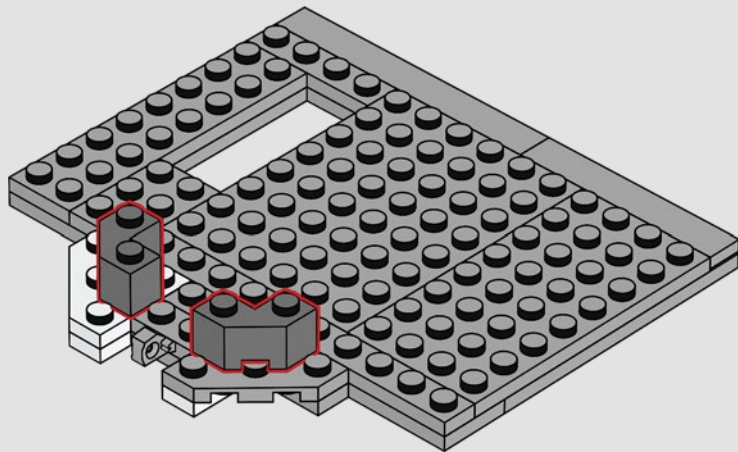



2x



1x

1066

1

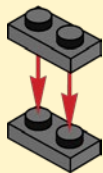

2

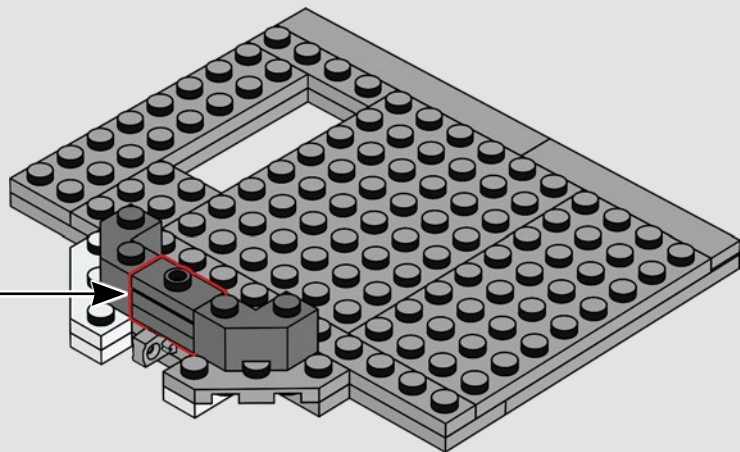
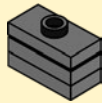

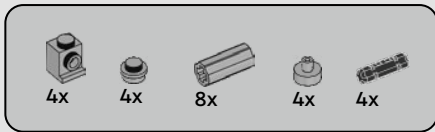

1067

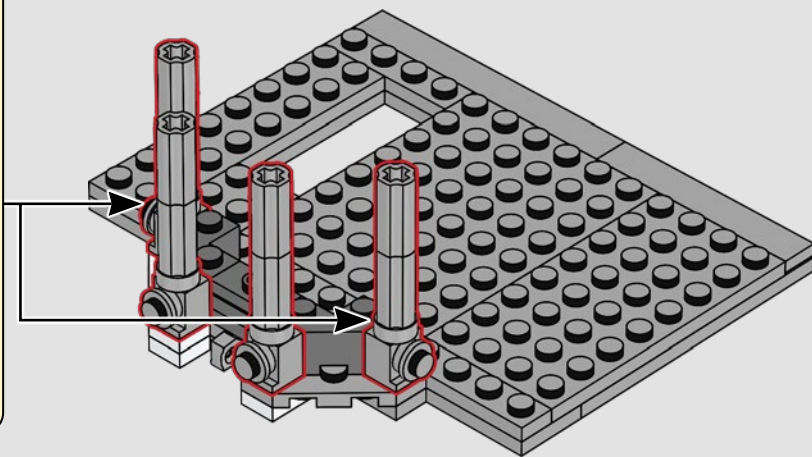
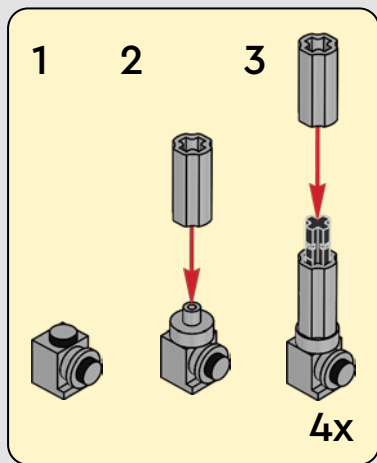

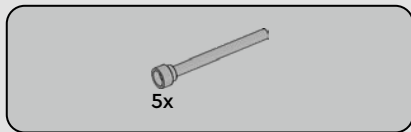

1068

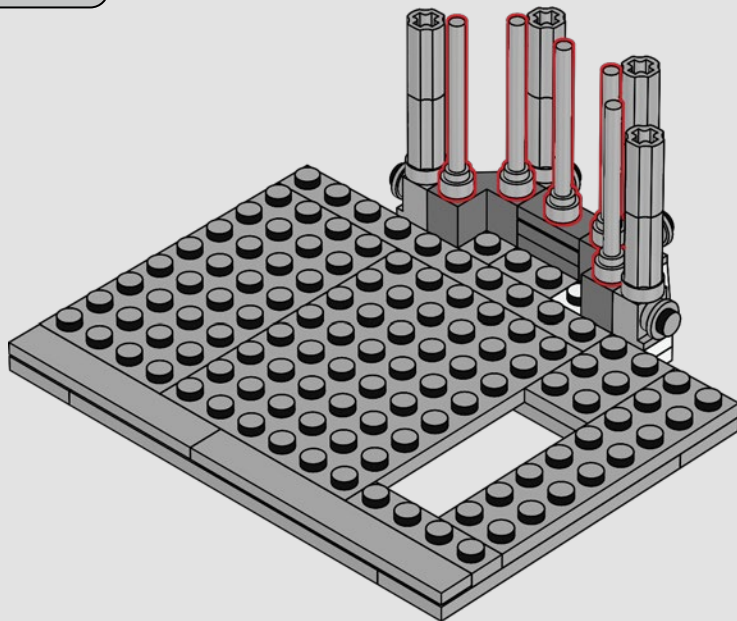



3x



1x

1069

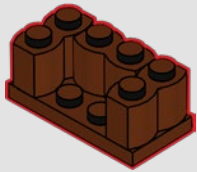

2x

1070

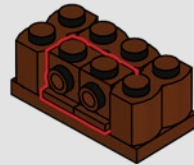

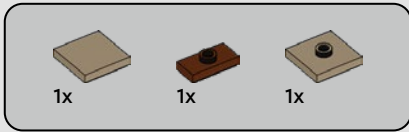

1071

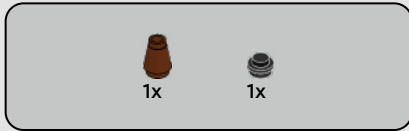
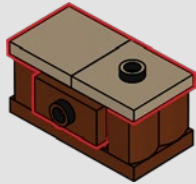

1072

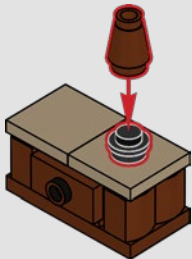

1073

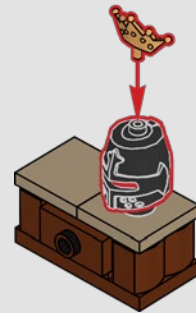

1074



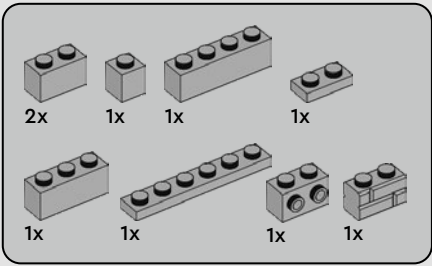

1075





2x



3x



1x

1076

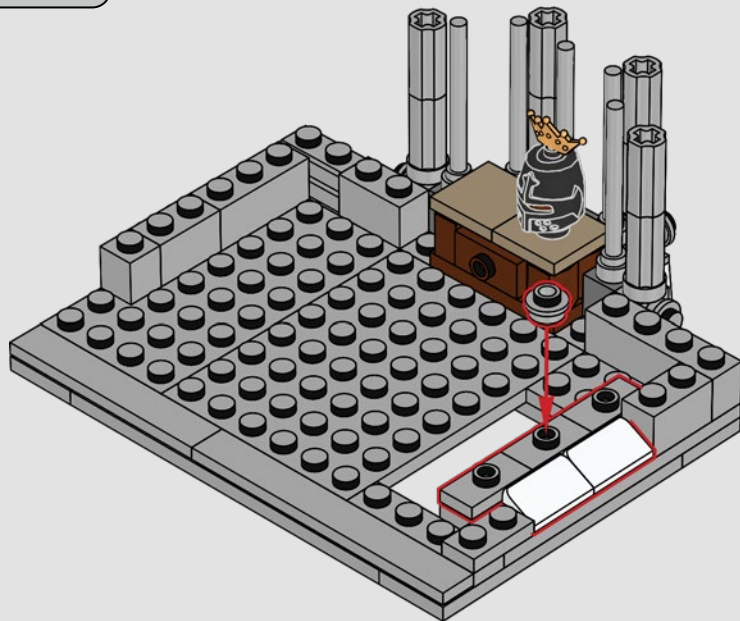

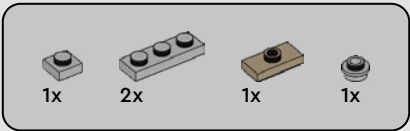

1077

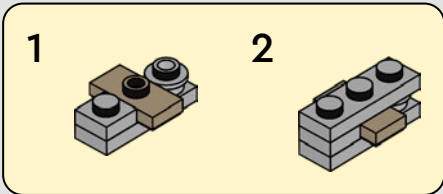

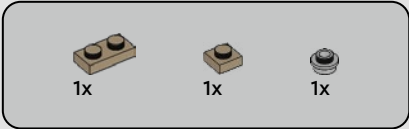

1078



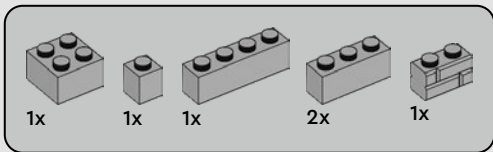

1079

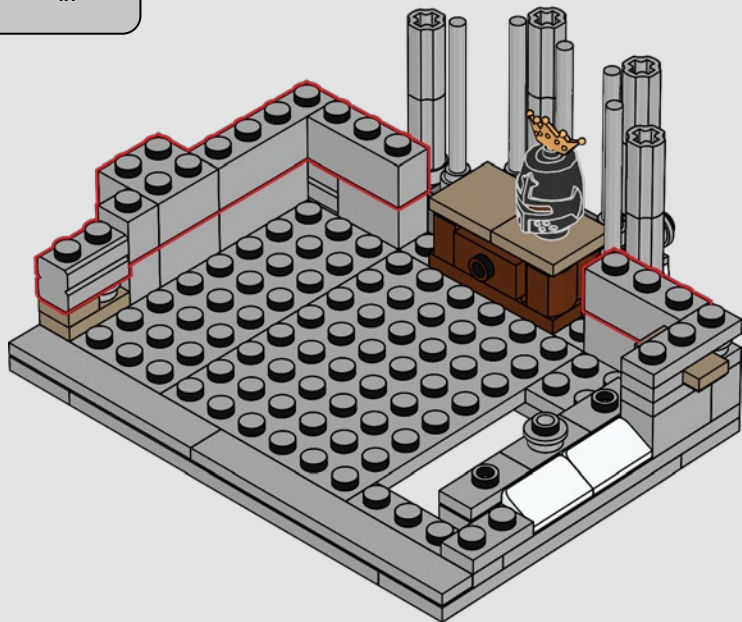

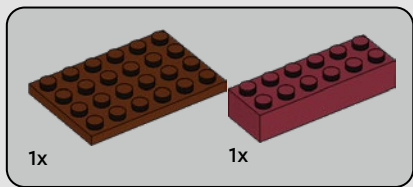
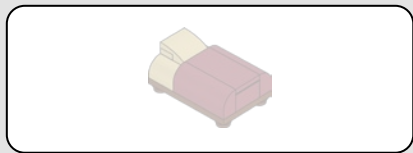

1080

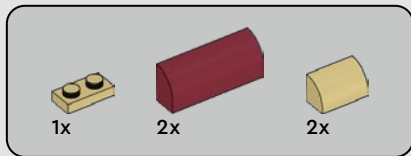
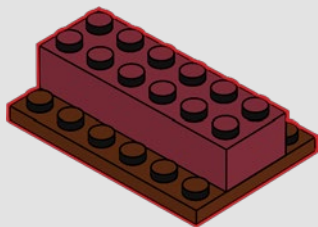

1081

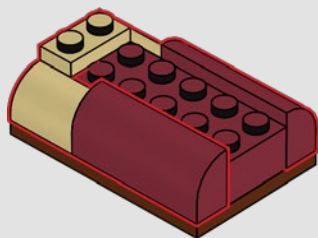

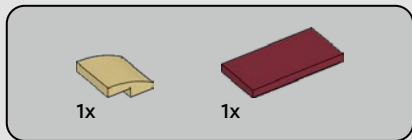

1082

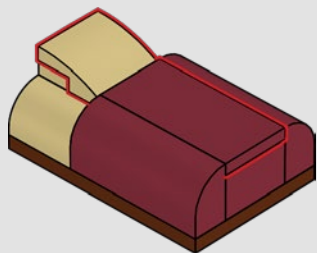

1083

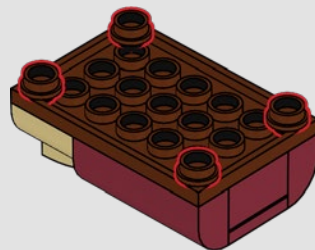

1084

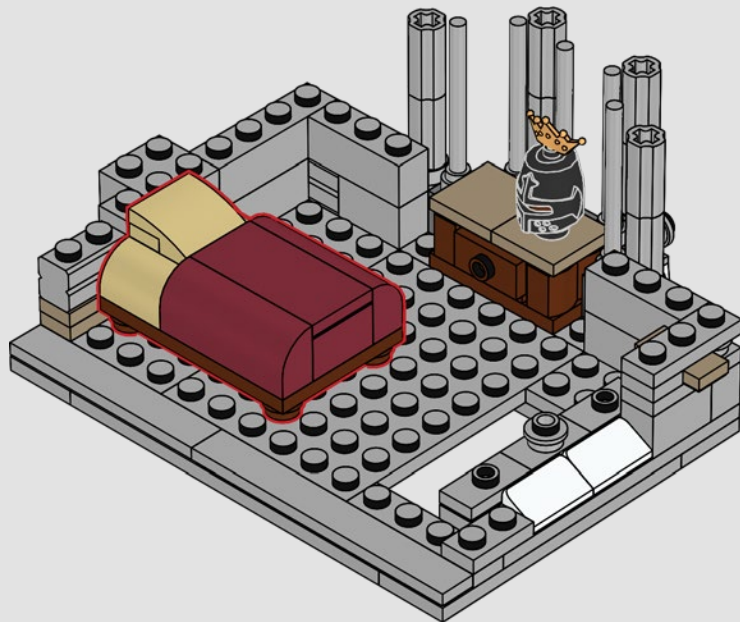

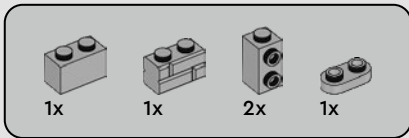

1085

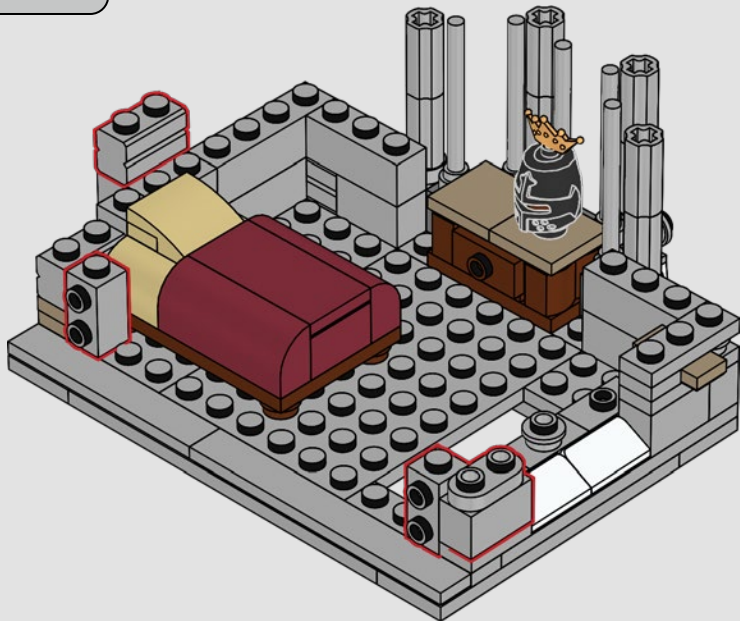



2x

1086

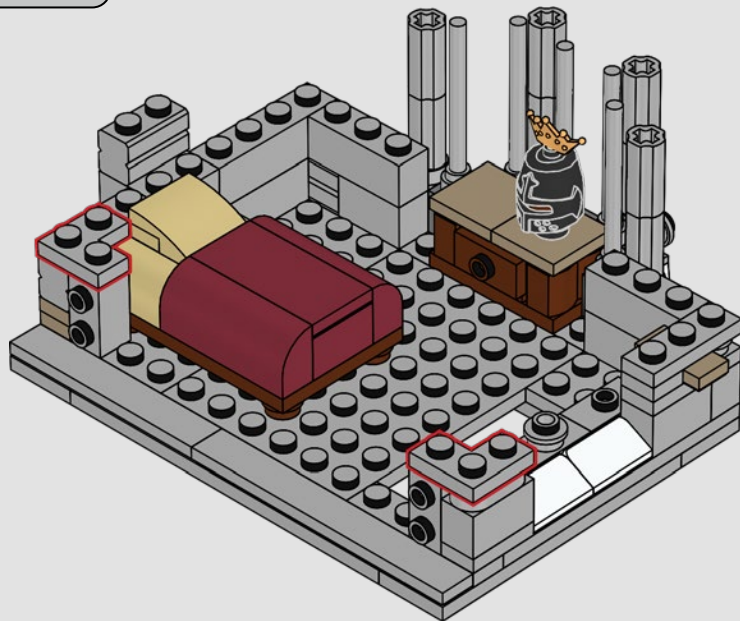

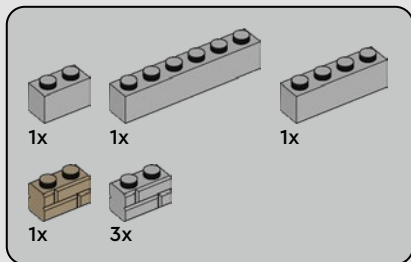

1087

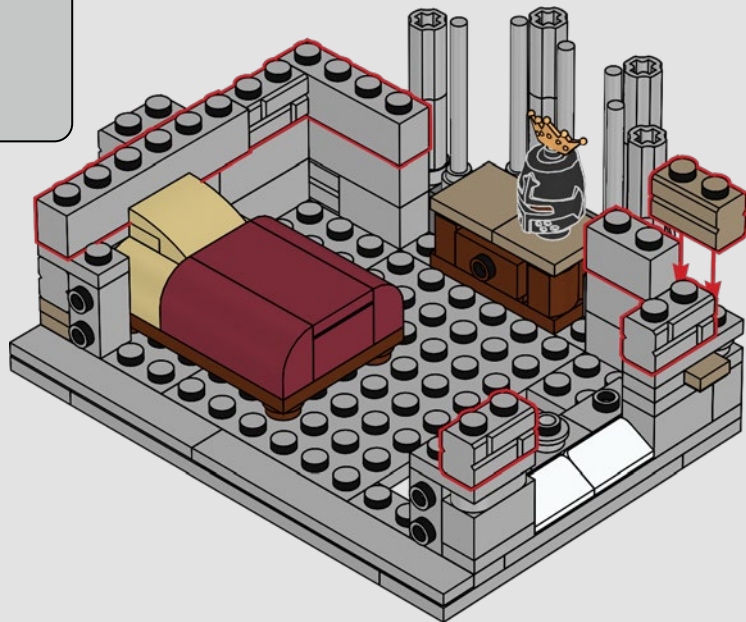



1x



1x

1088

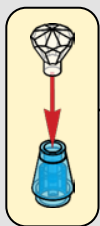

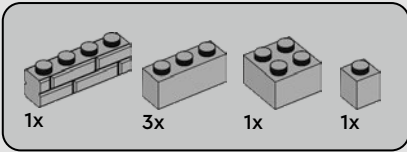

1089





1x



1x

1090

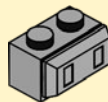

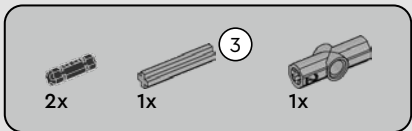
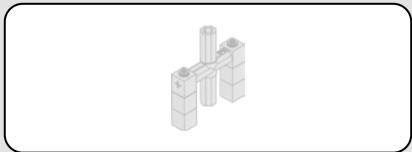

1091

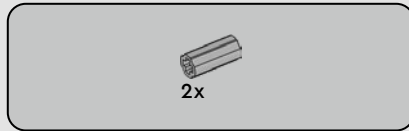
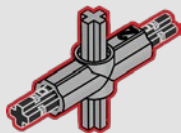

1092

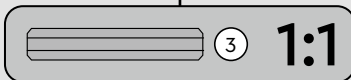
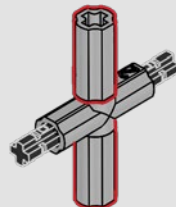



2x

1093

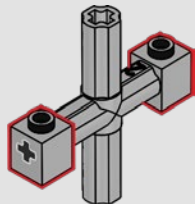

4x

1094

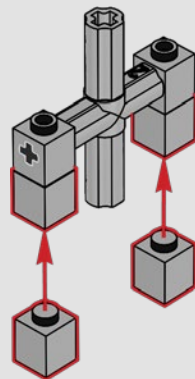

1095

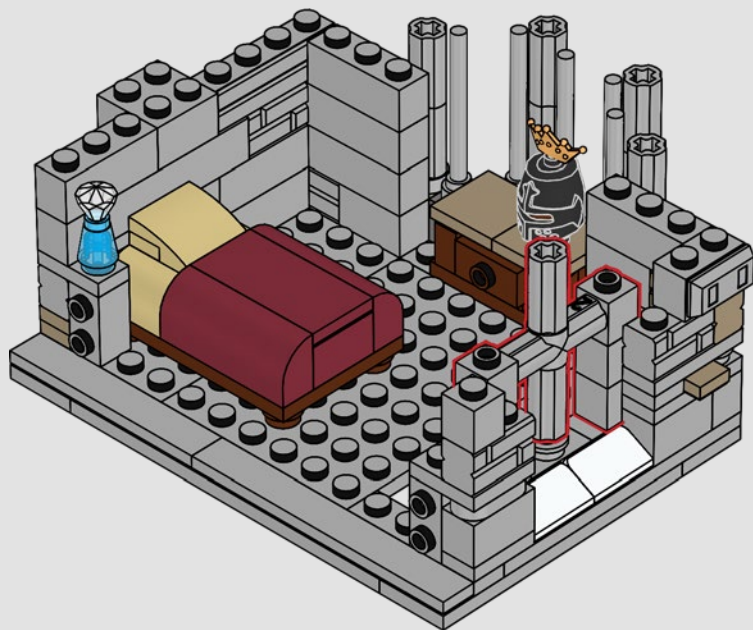

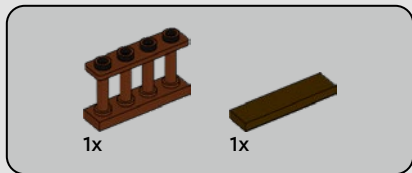

1096



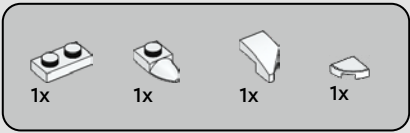

1097

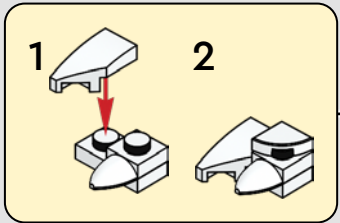
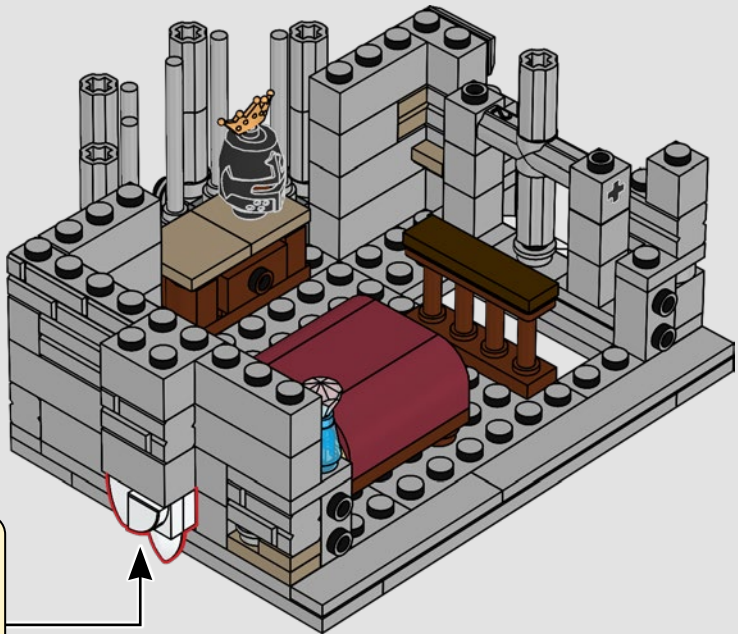

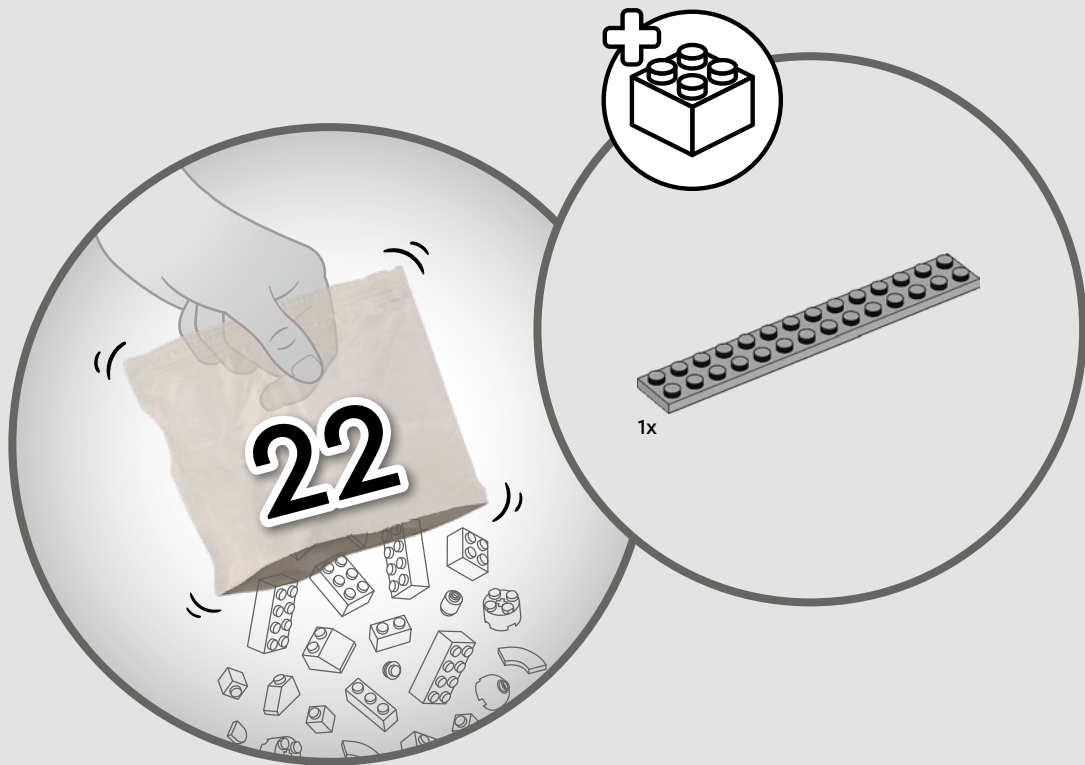

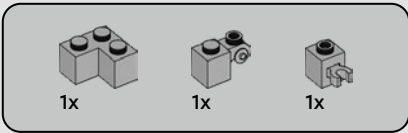

1098



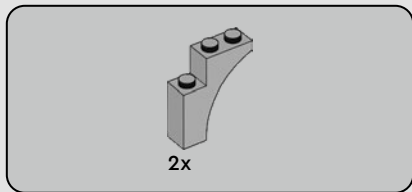

1099

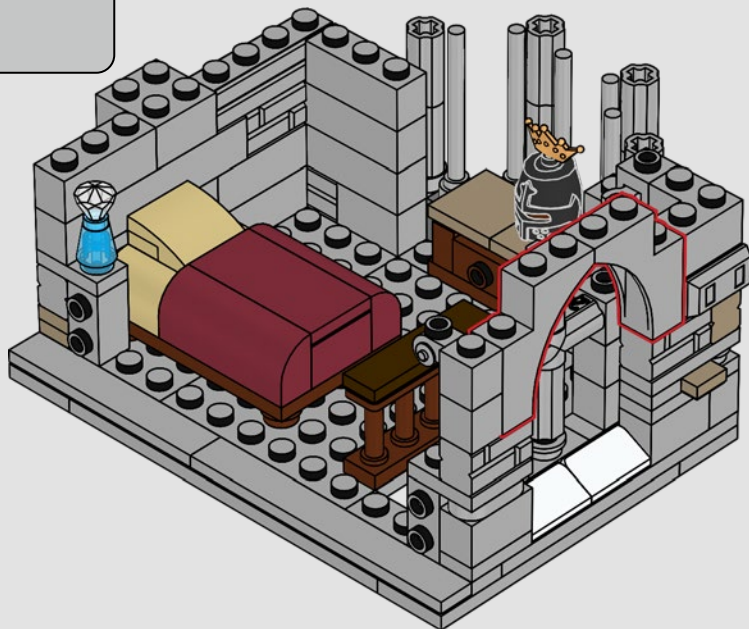

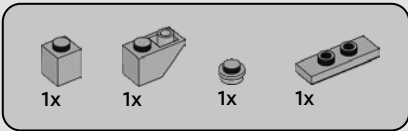

1100

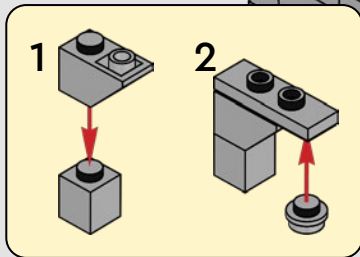
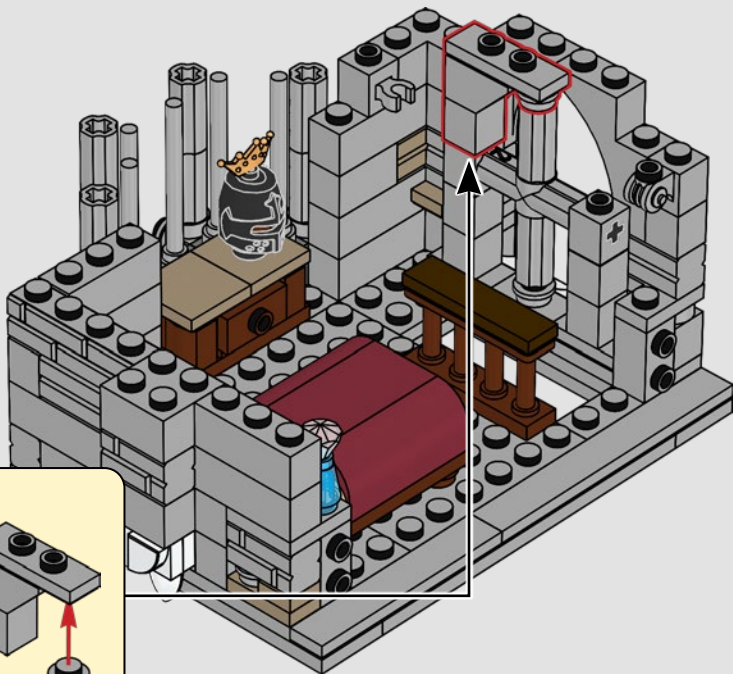



1x



1x



1x

1101

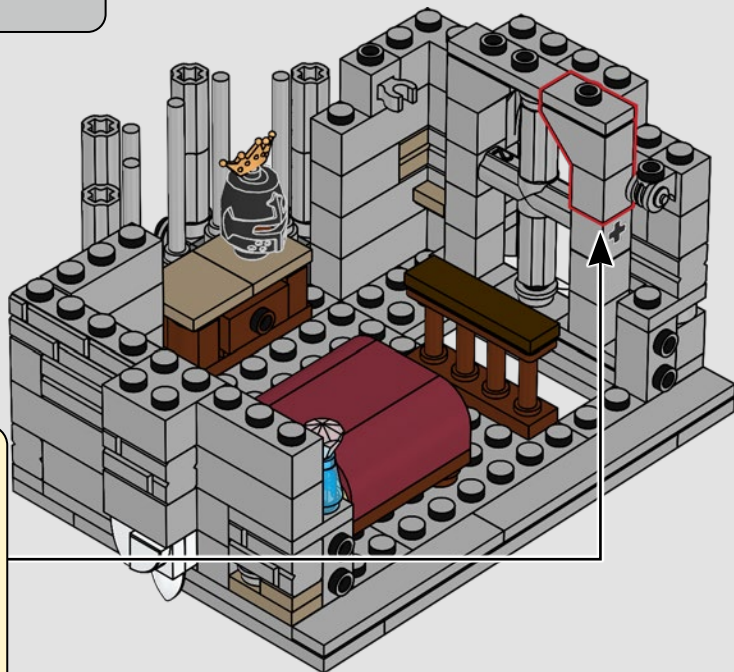

1

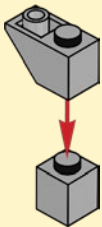

2

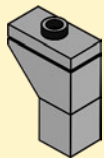



1x



1x

1102

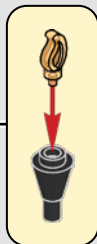



1x



1x

1103

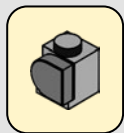

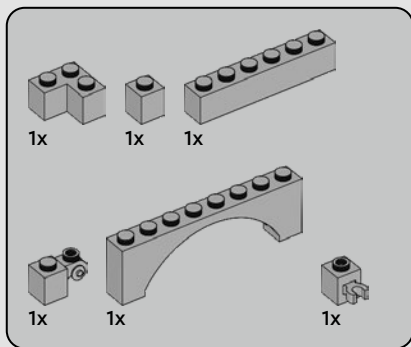

1104

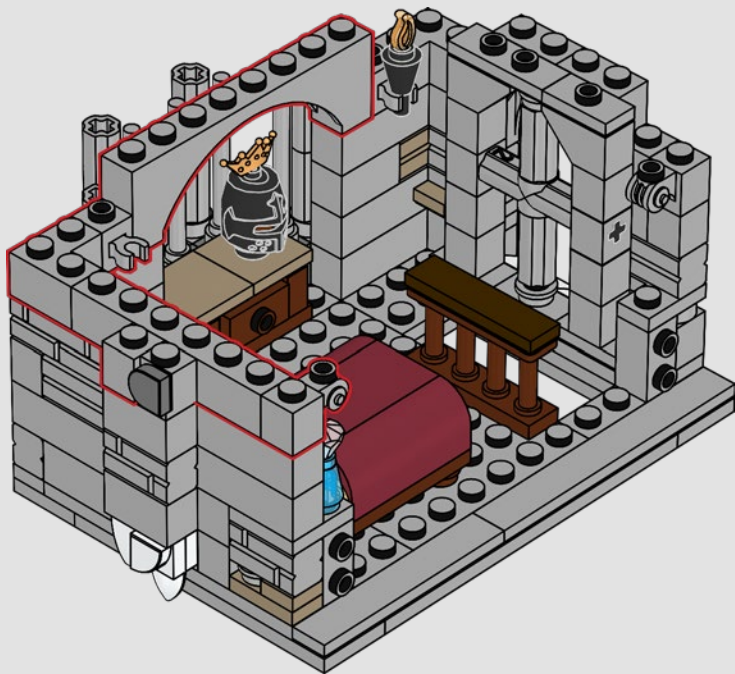



1x



1x

1105

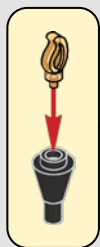



4x

1106

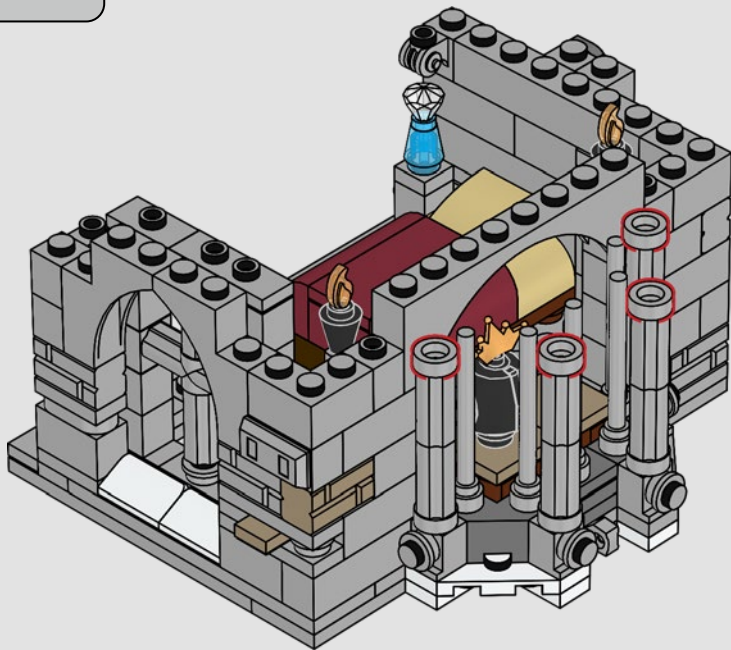

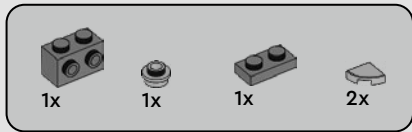

1107

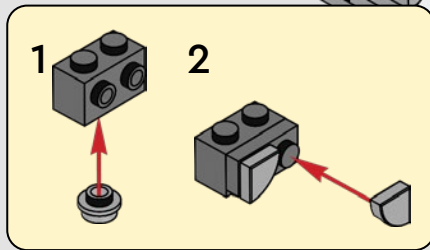
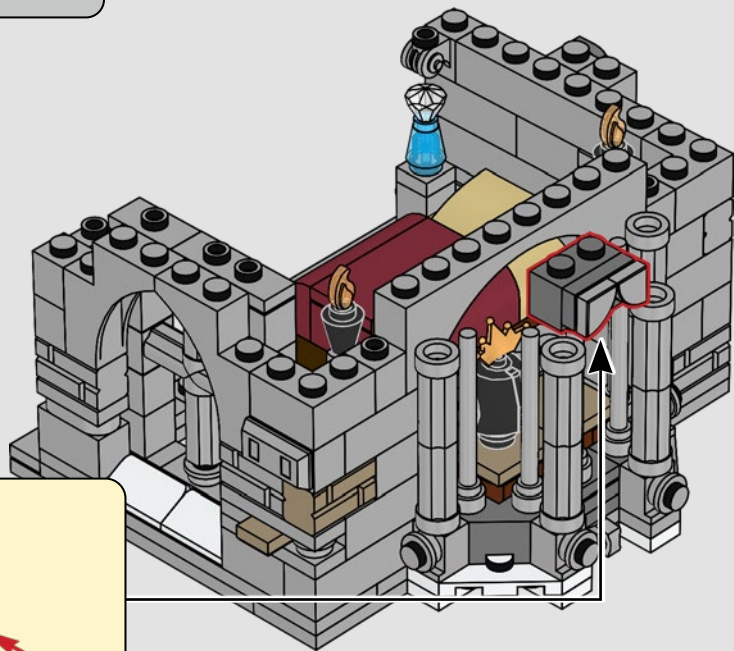



4x



4x



4x



4x

1108

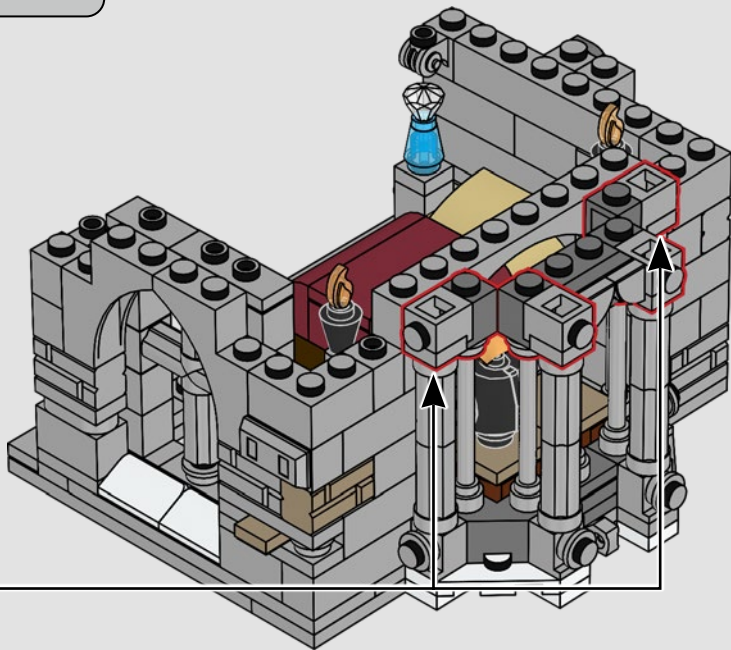

1



2



4x



2x



1x

1109

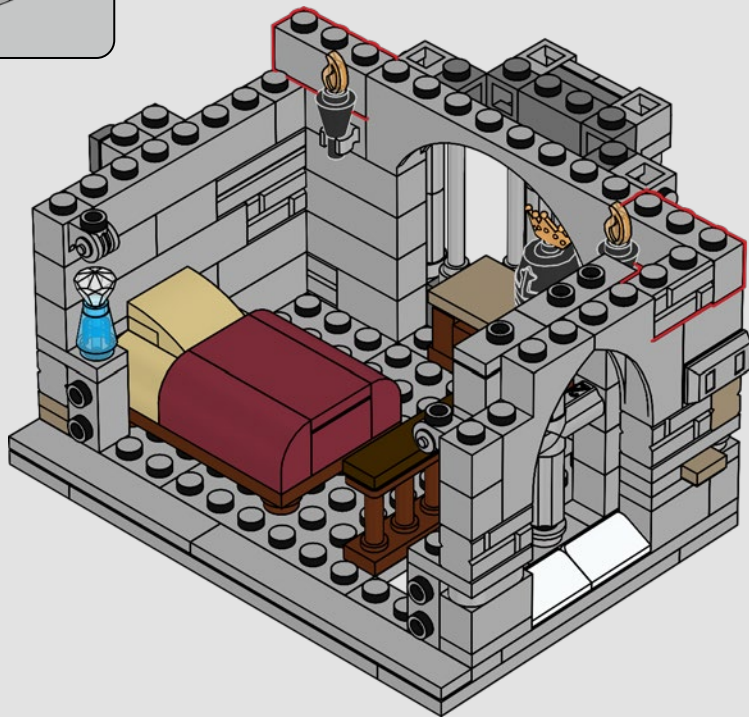



1x



1x

1110

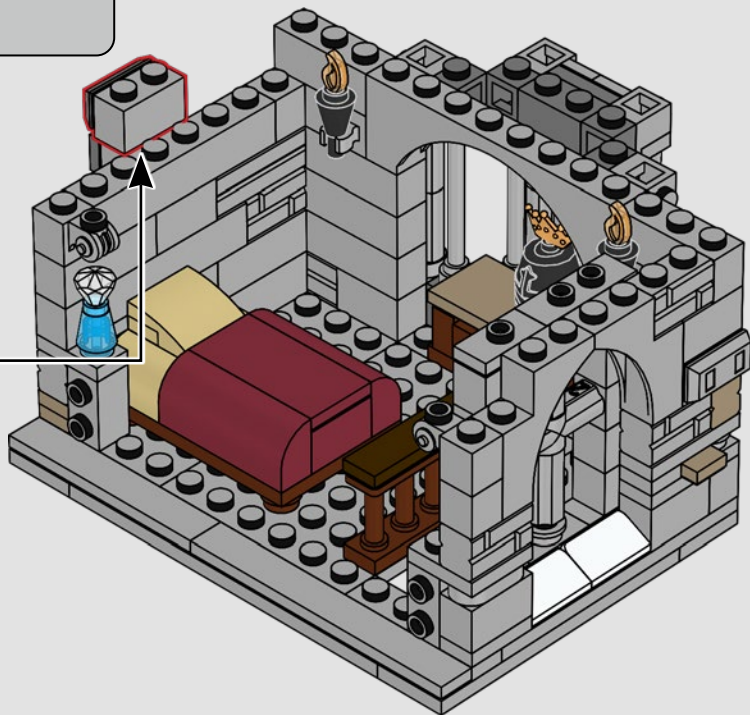
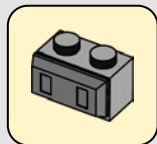

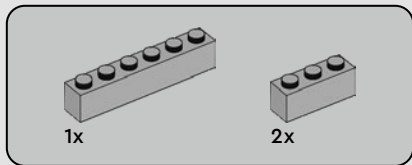

1111



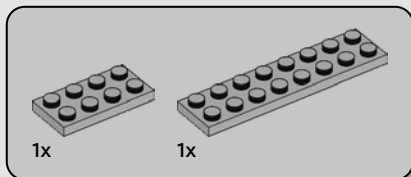

1112

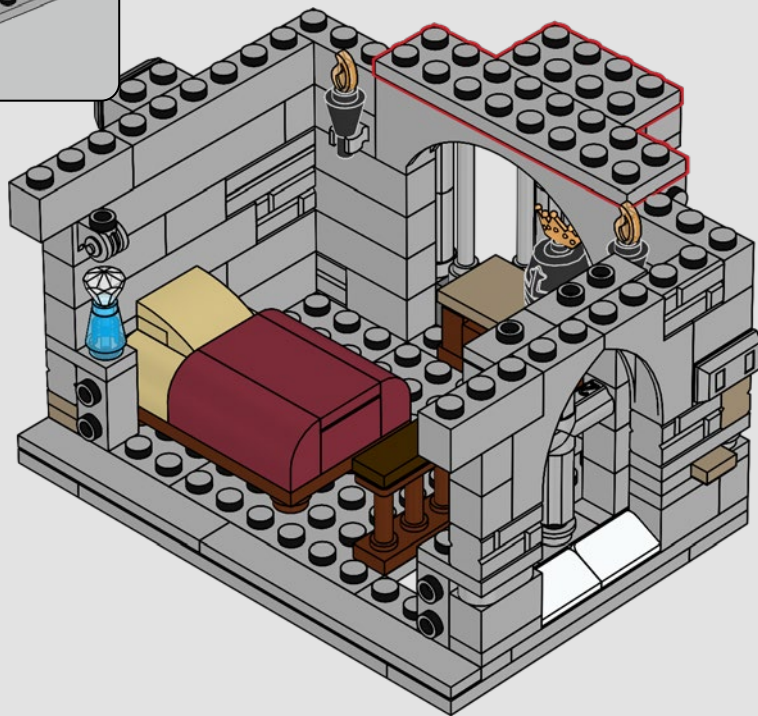

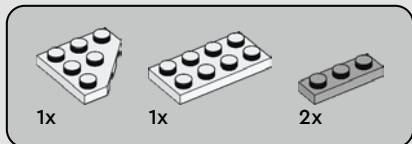

1113



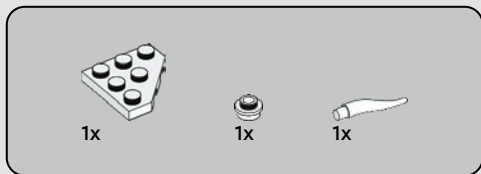

1114

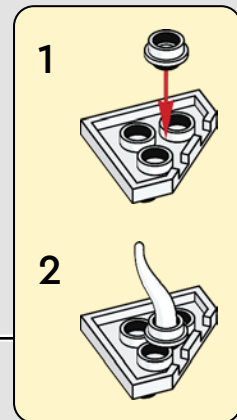
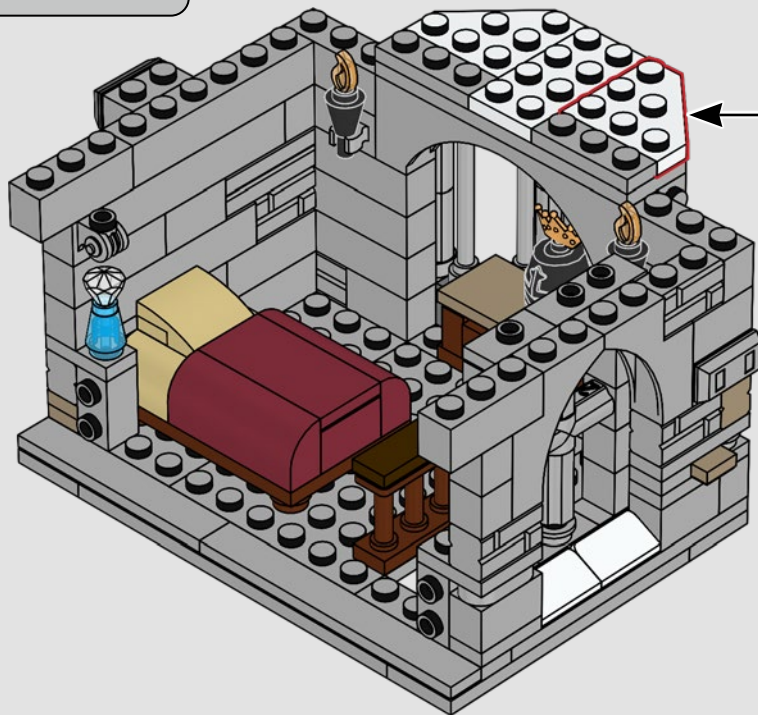

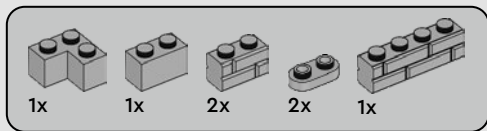

1115

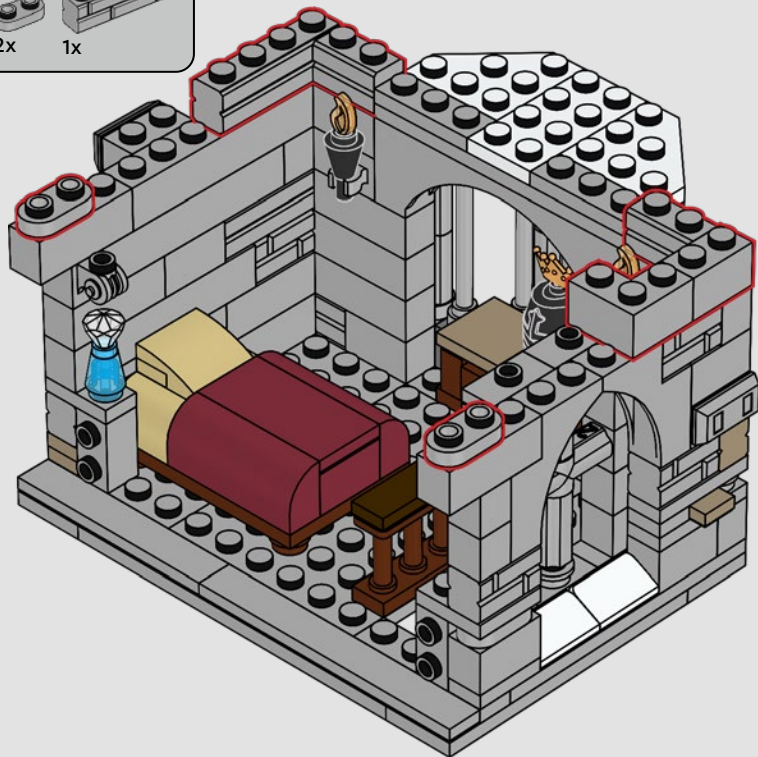

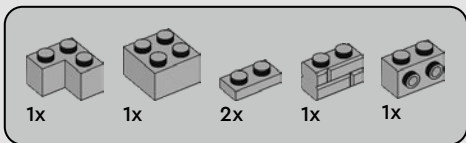

1116

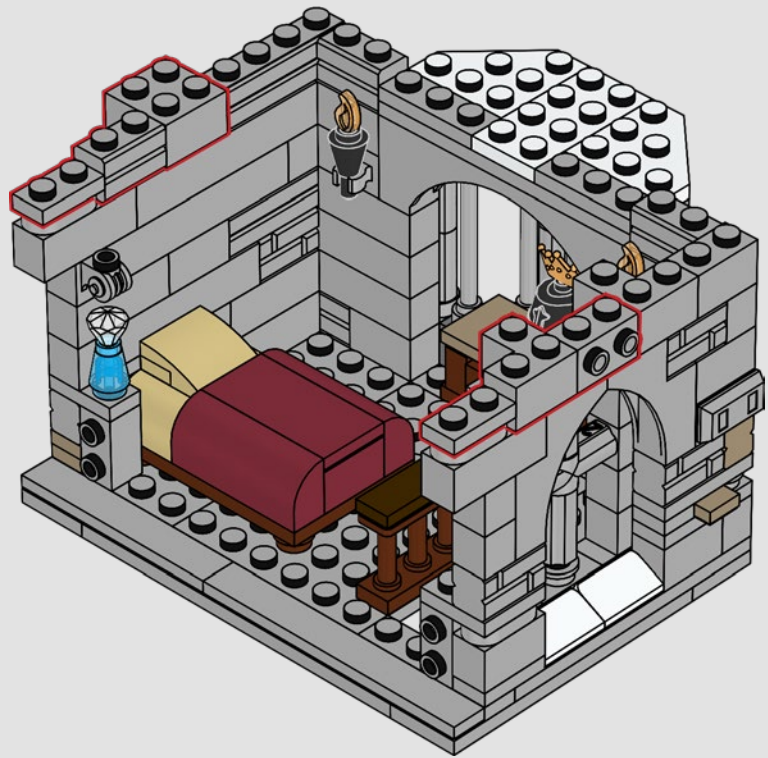



1x



4x

1117

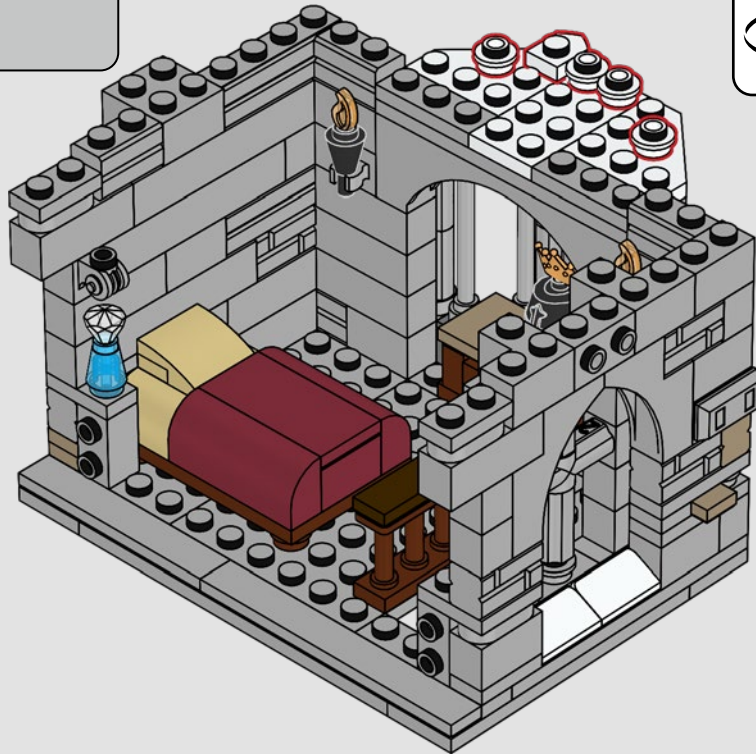
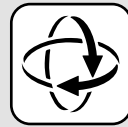



2x



2x

1118

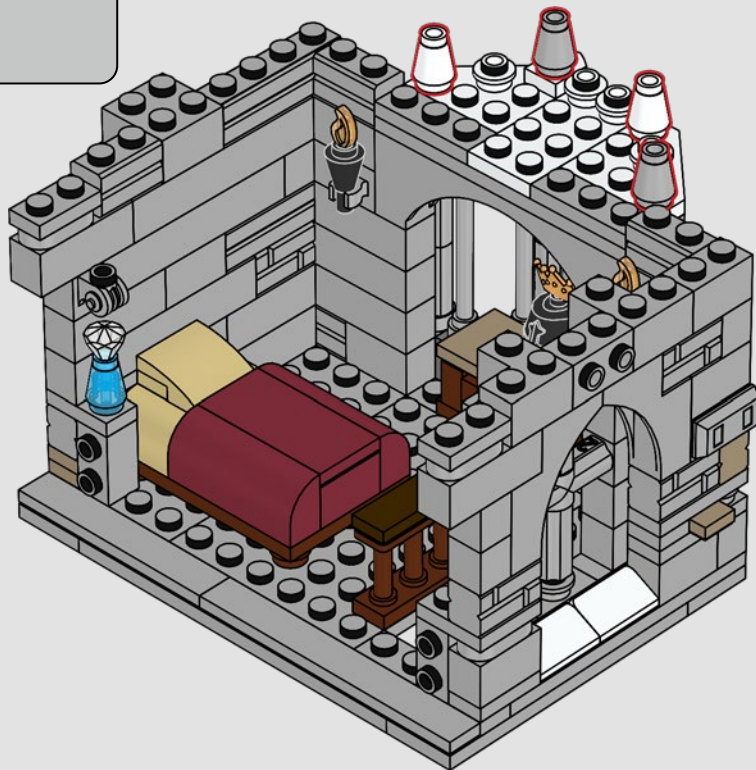



4x

1119





3x



1x

1120



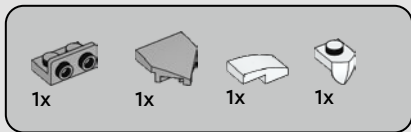

1121

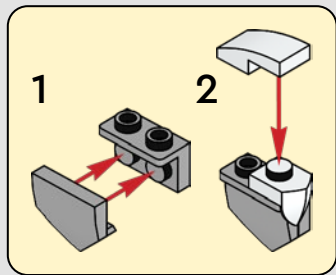

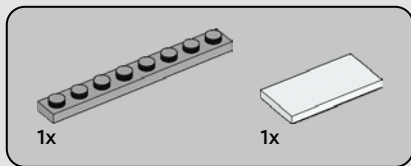

1122



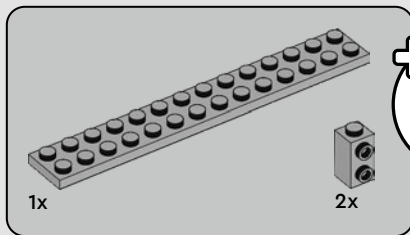

1123

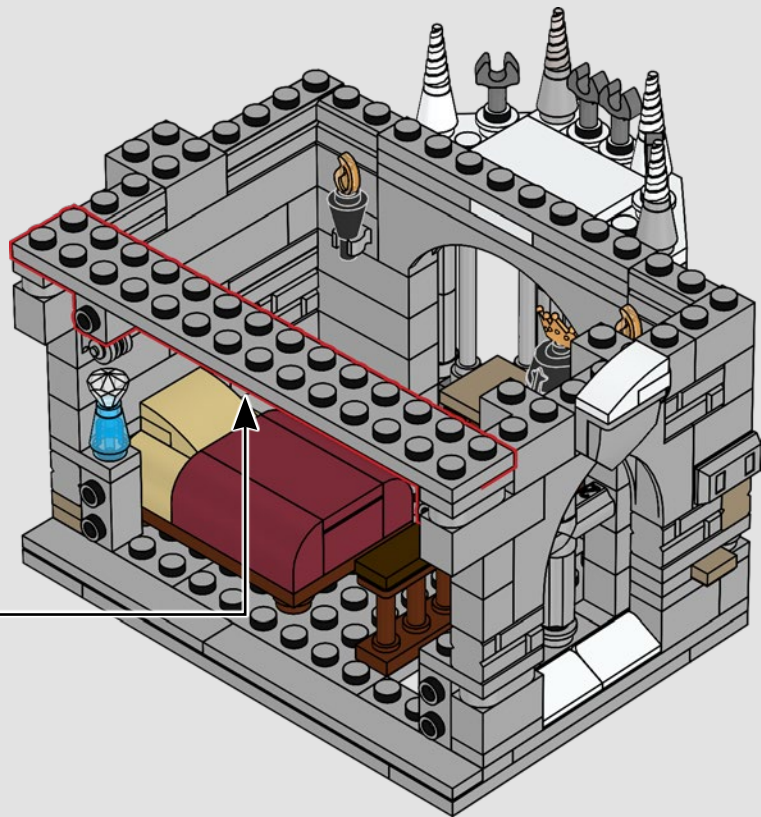
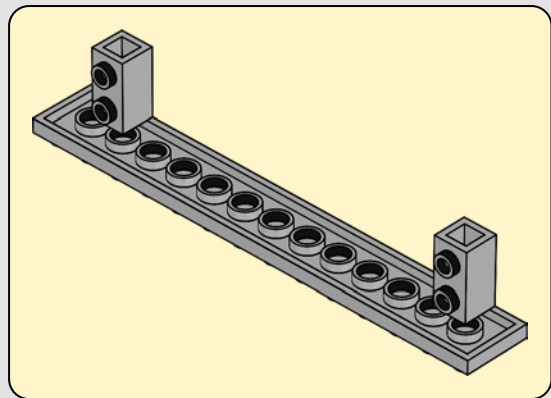

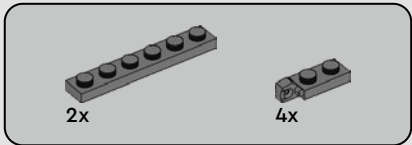

1124

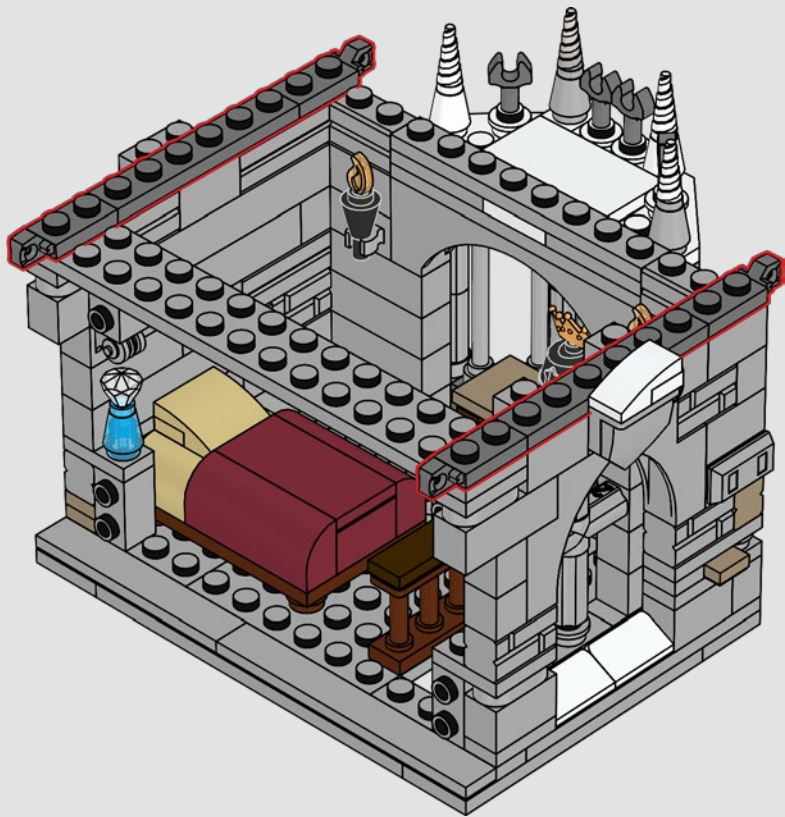

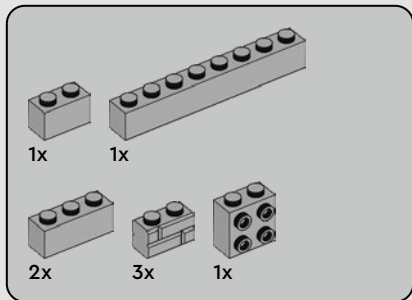

1125

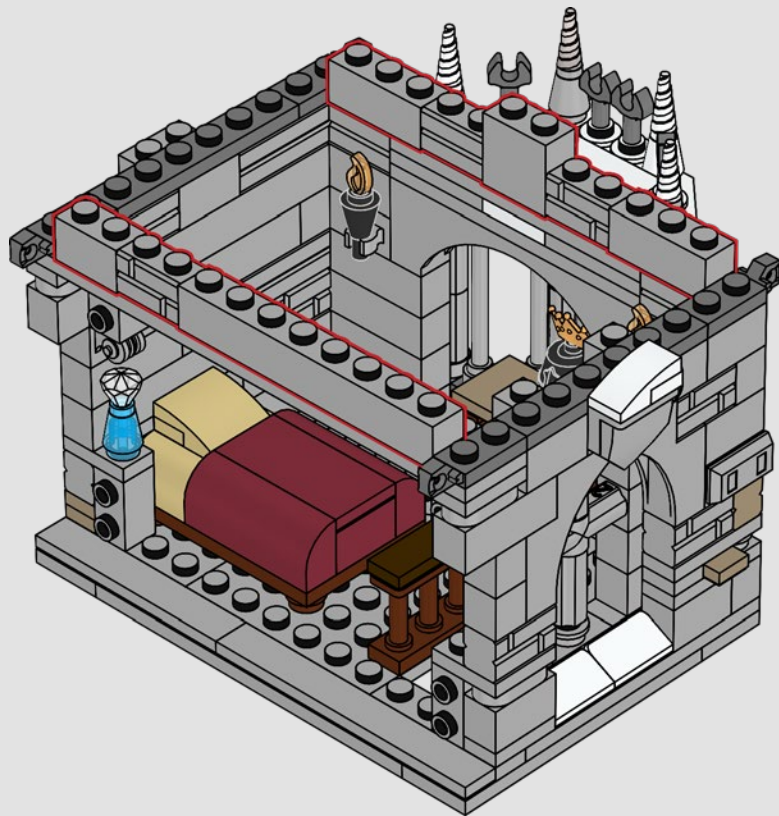

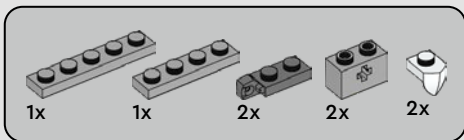

1126

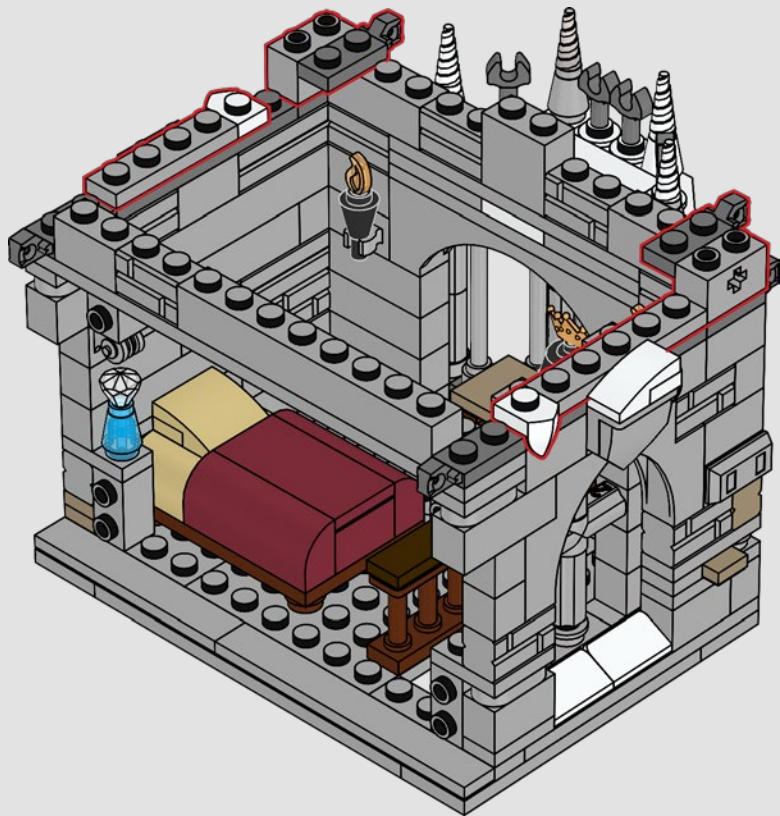

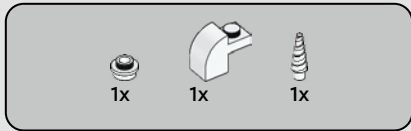

1127

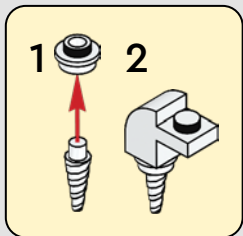
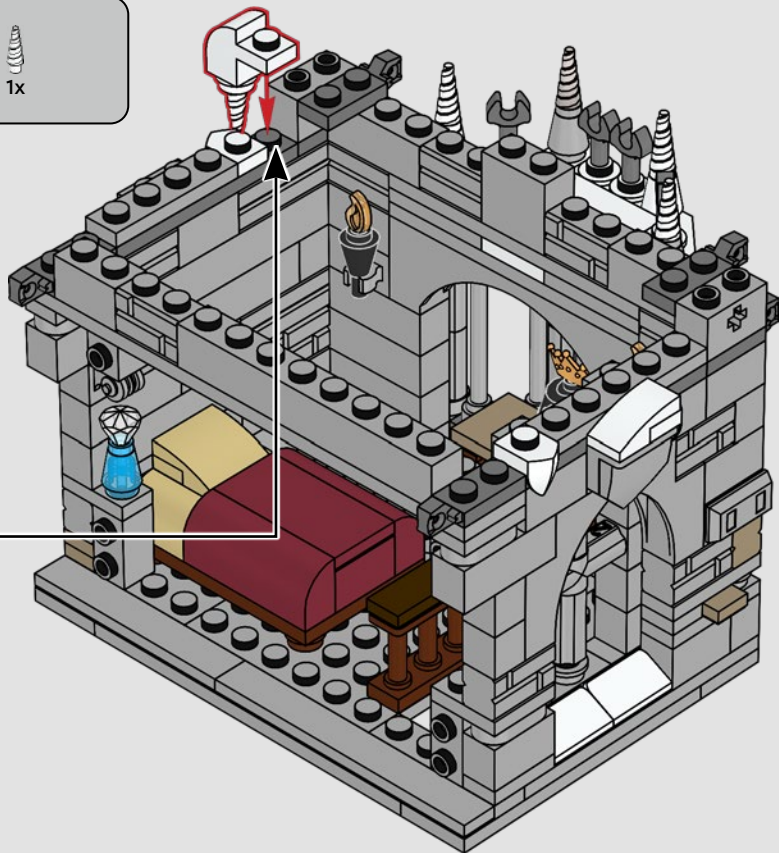

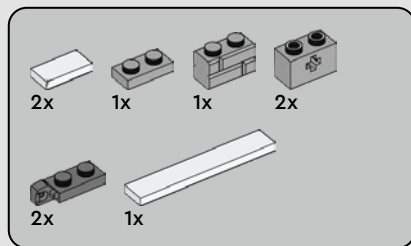

1128

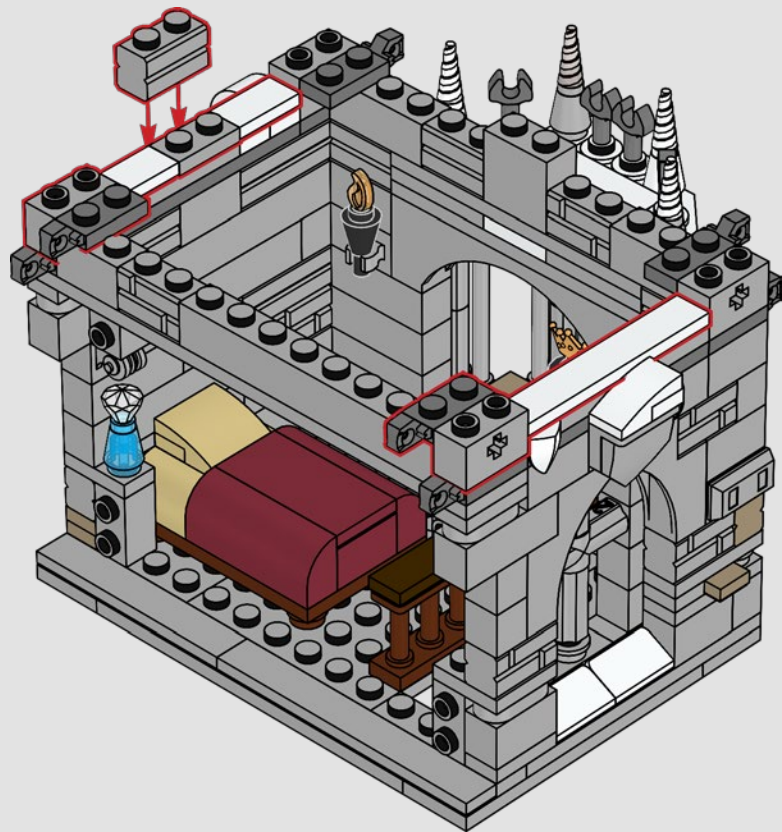

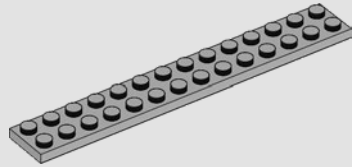
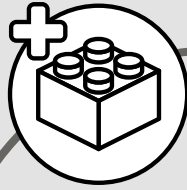

1x

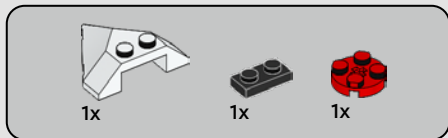

1129

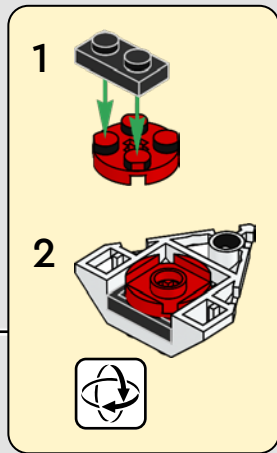
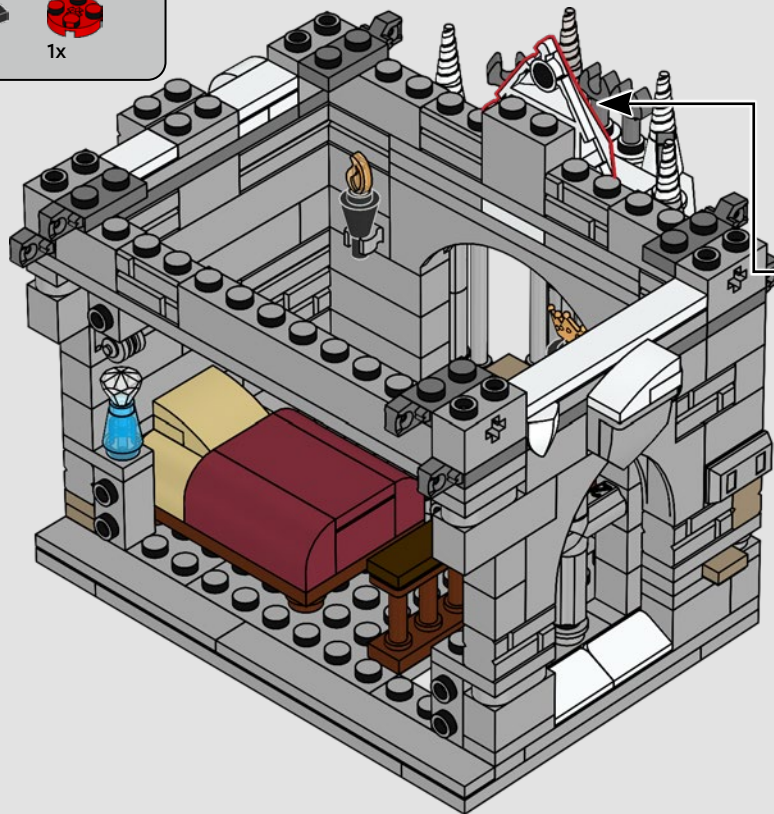



5x

1130

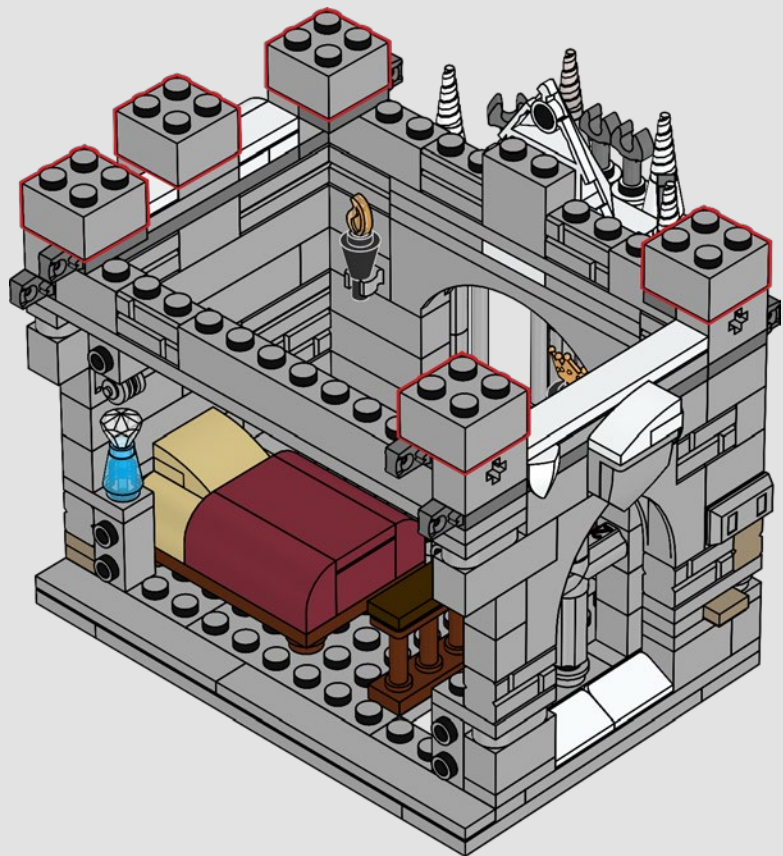

1004

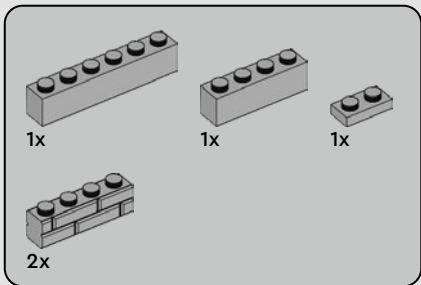

1131

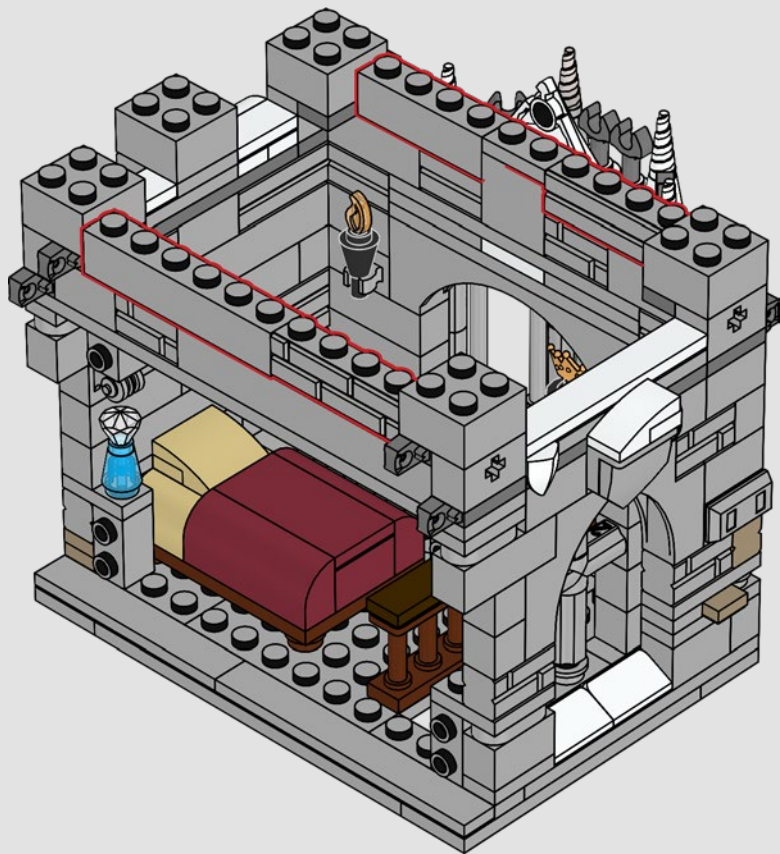

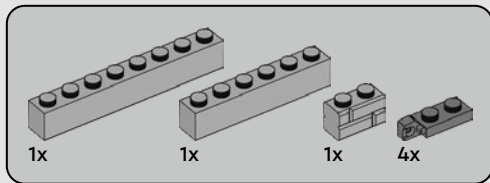

1132

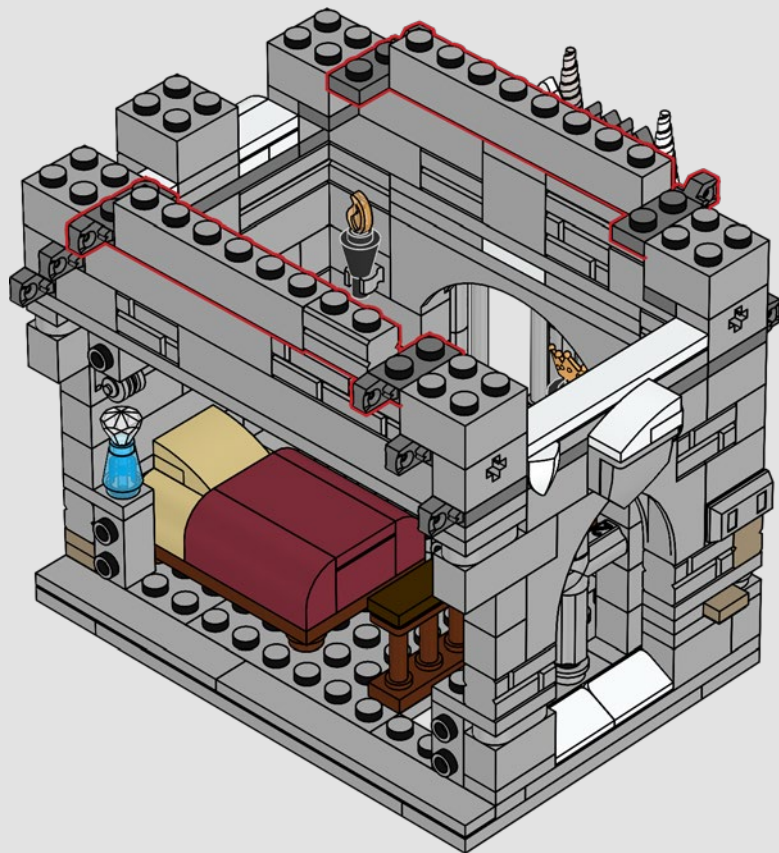

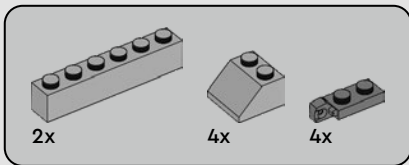

1133

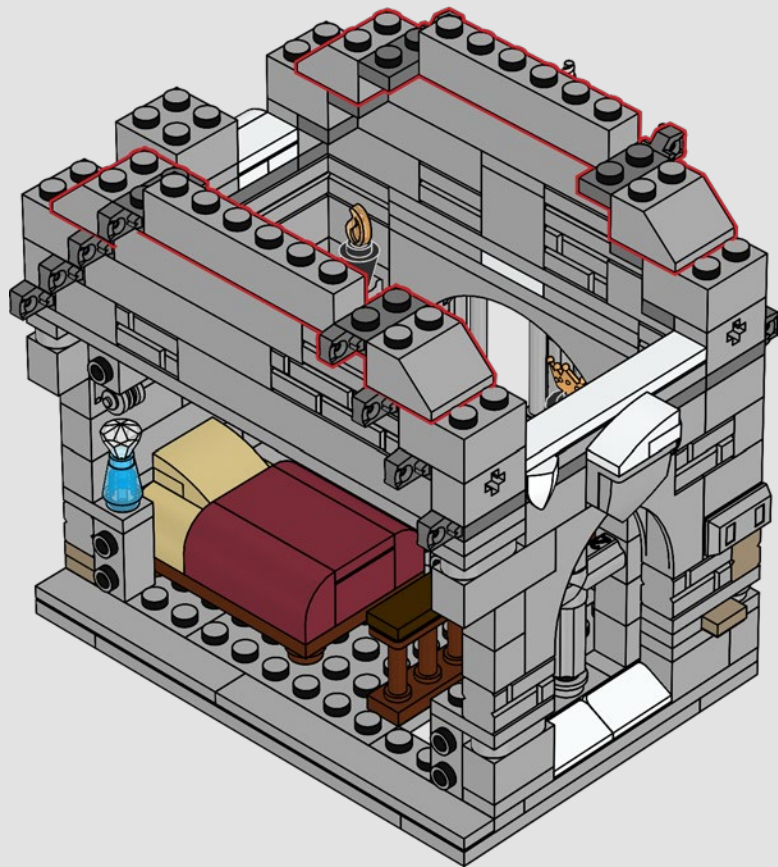

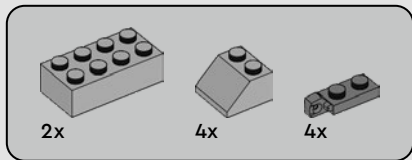

1134

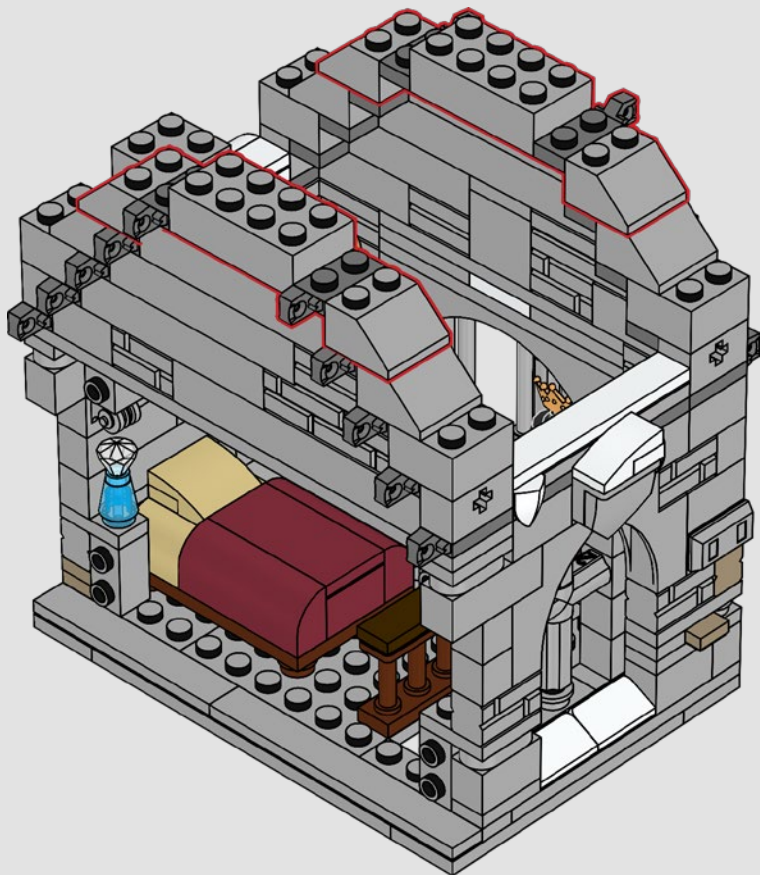

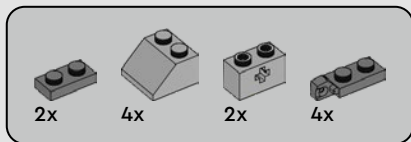

1135

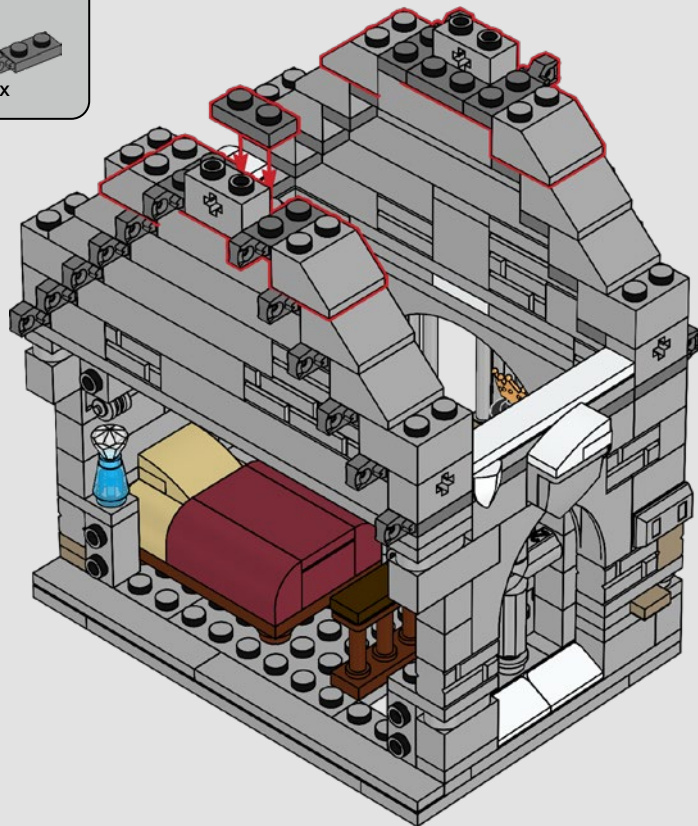

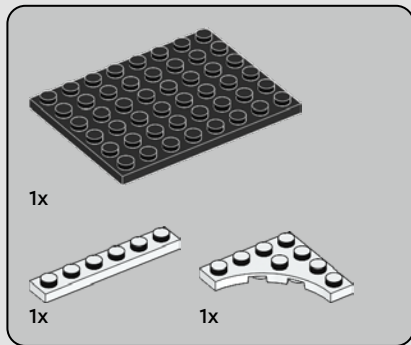
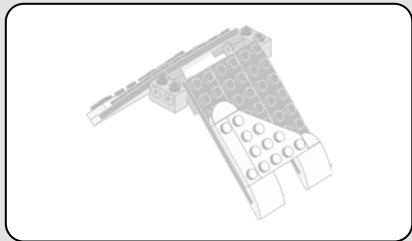

1136

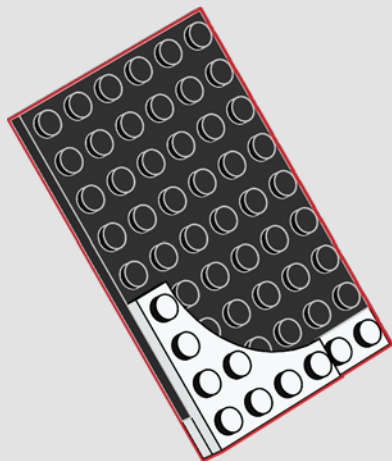

1x



1x

1137

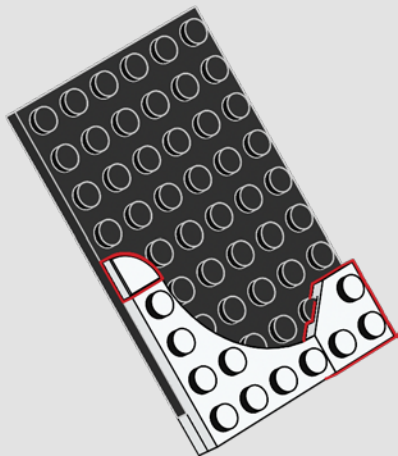

2x

1138

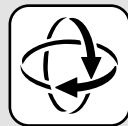
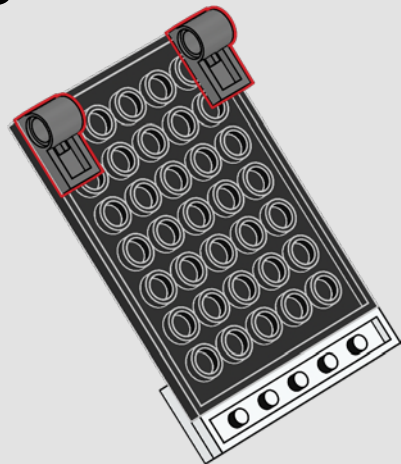

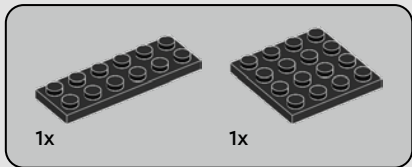
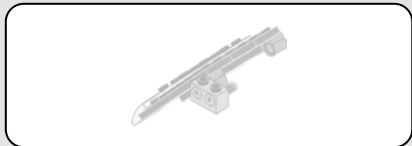

1139

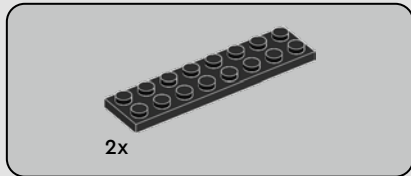
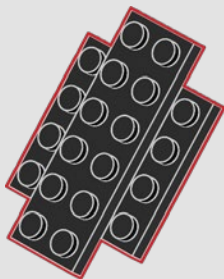

1140

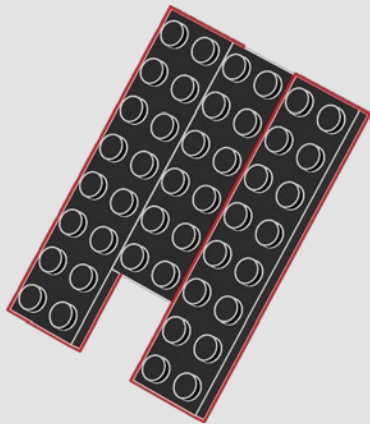

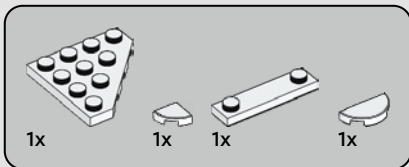

1141

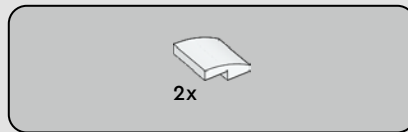
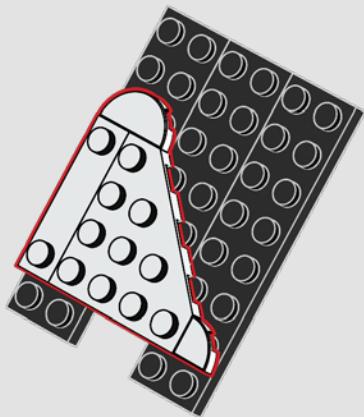

1142

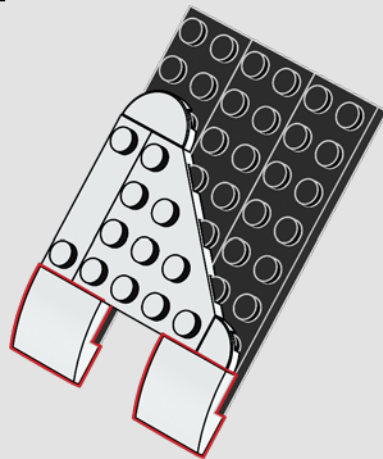

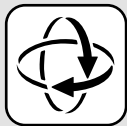

1143

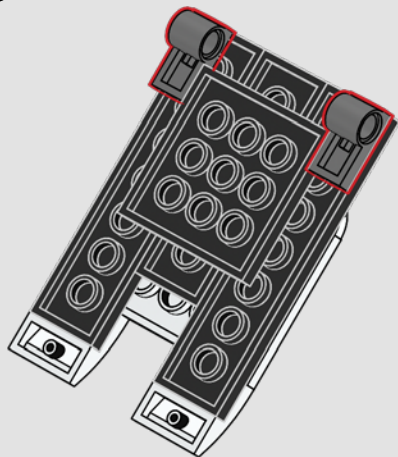

1144

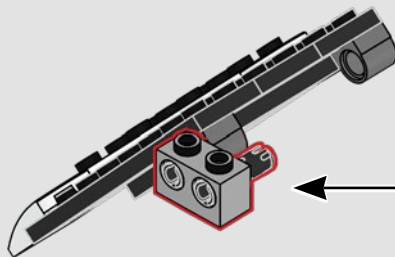

1145

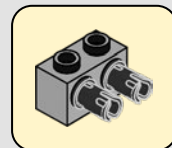
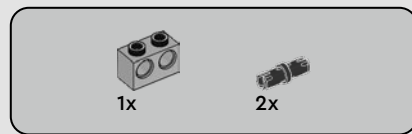
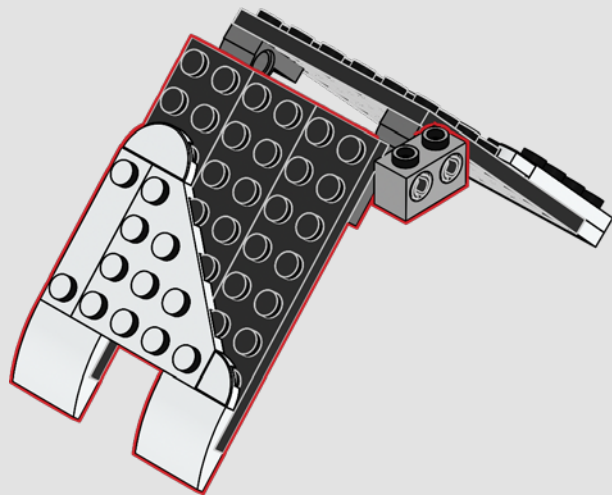

1146

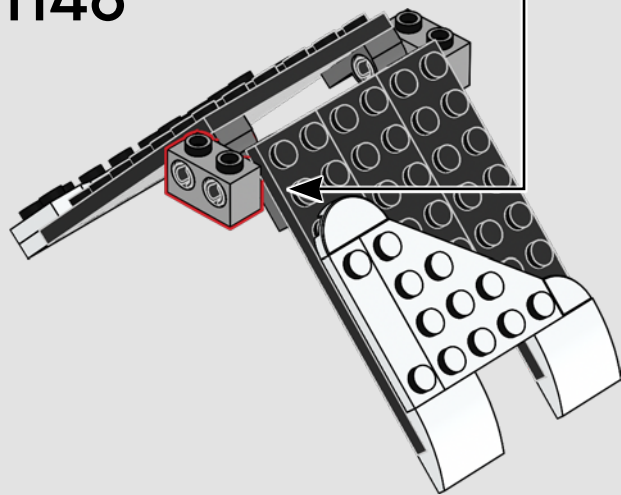

1147

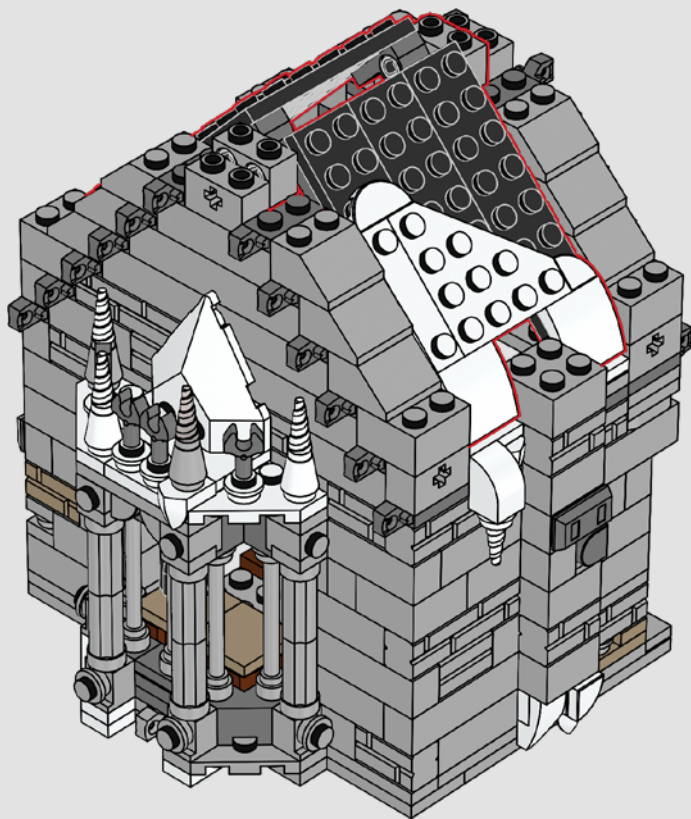



4x



2x

1148

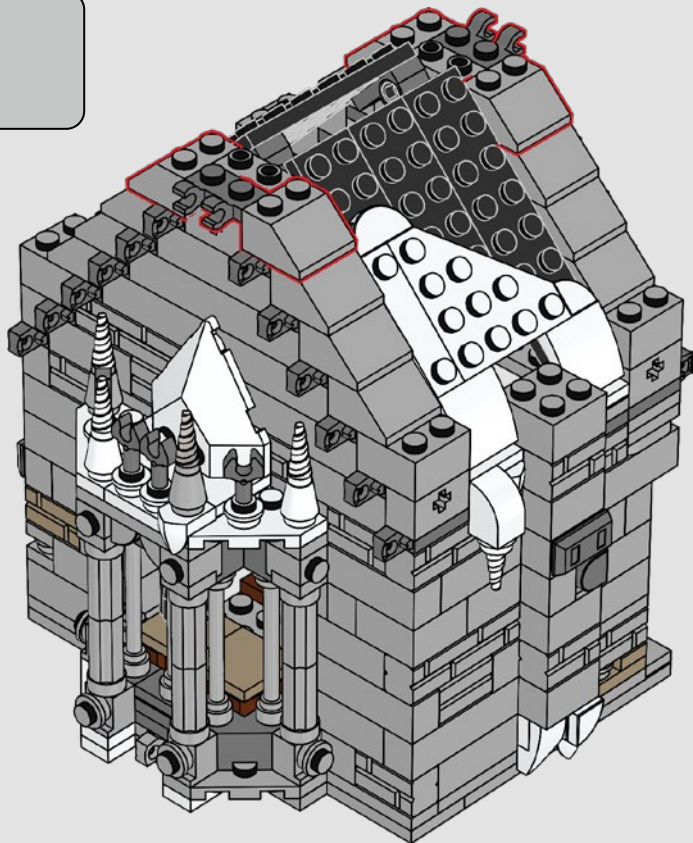



8x

1149

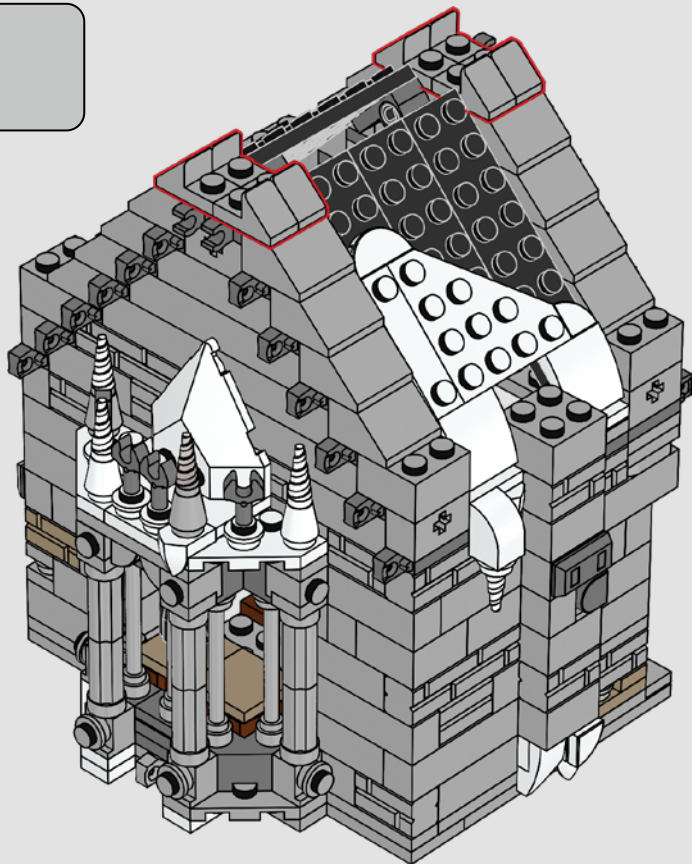

1018



2x

1150

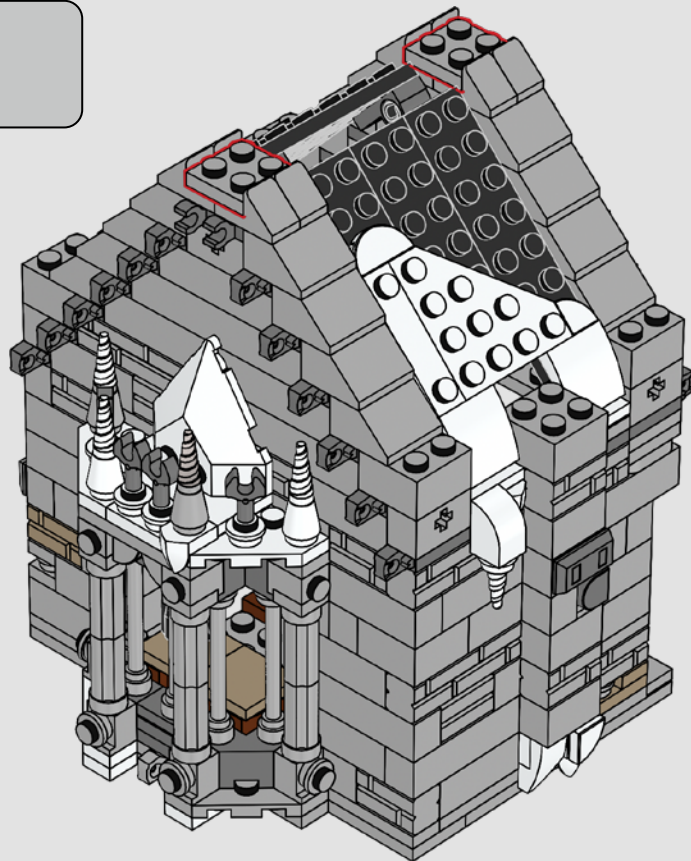

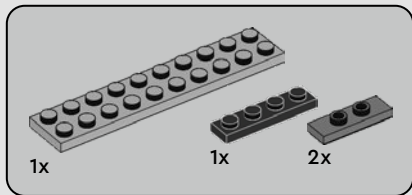

1151

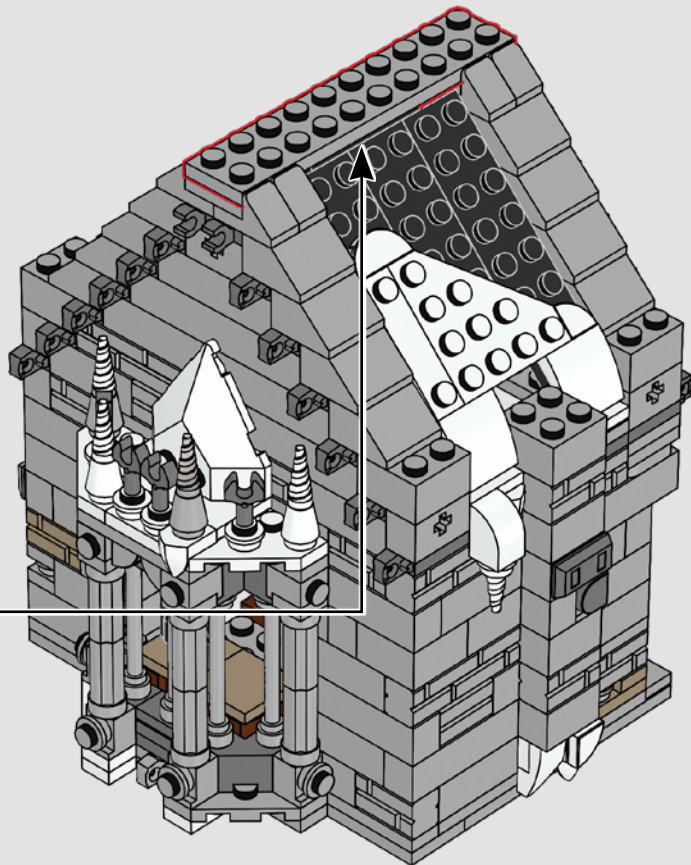
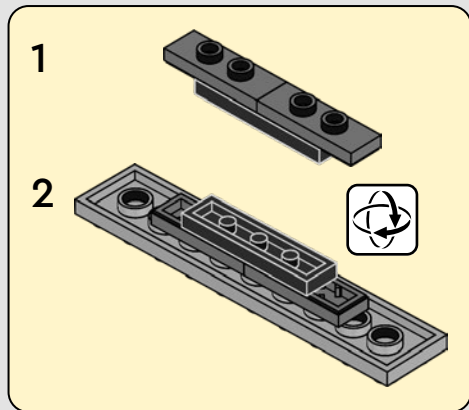



2x

1152

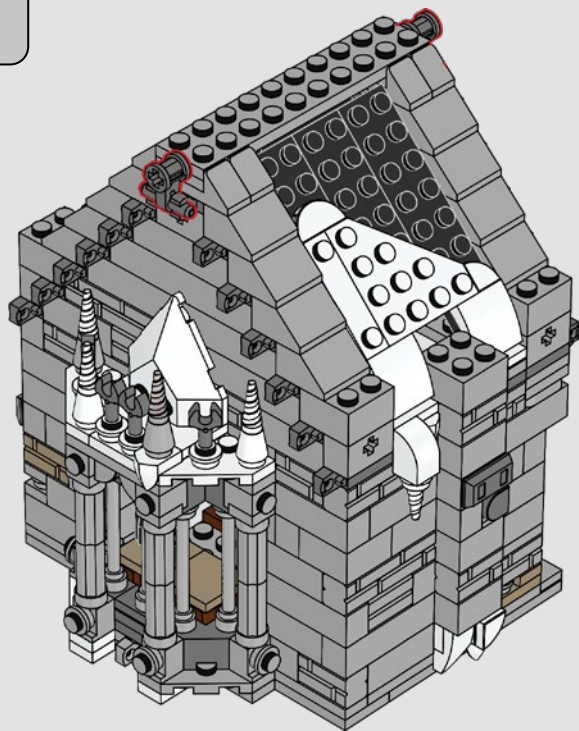



1x



2x

1153

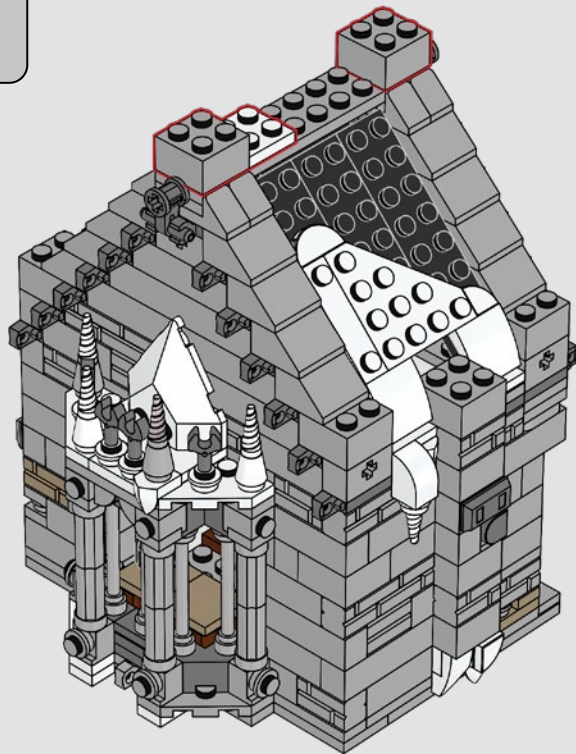

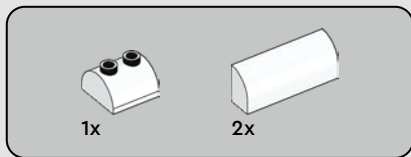

1154

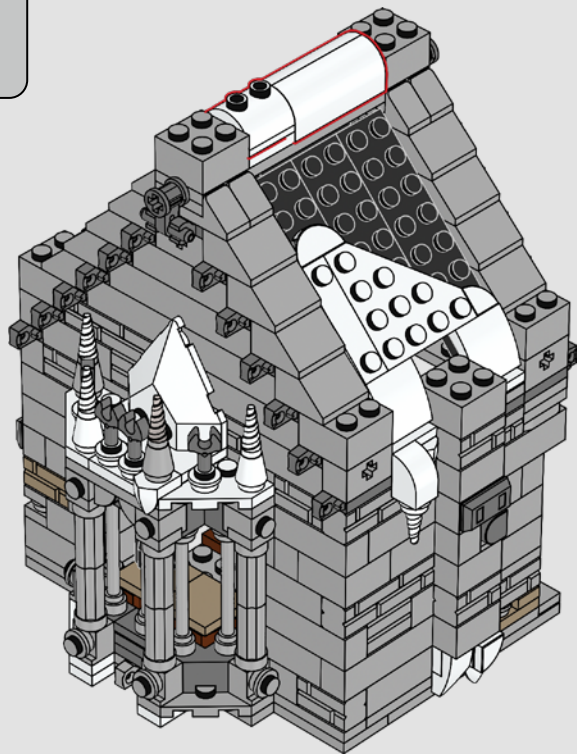

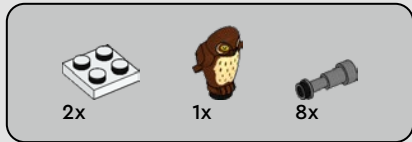

1155

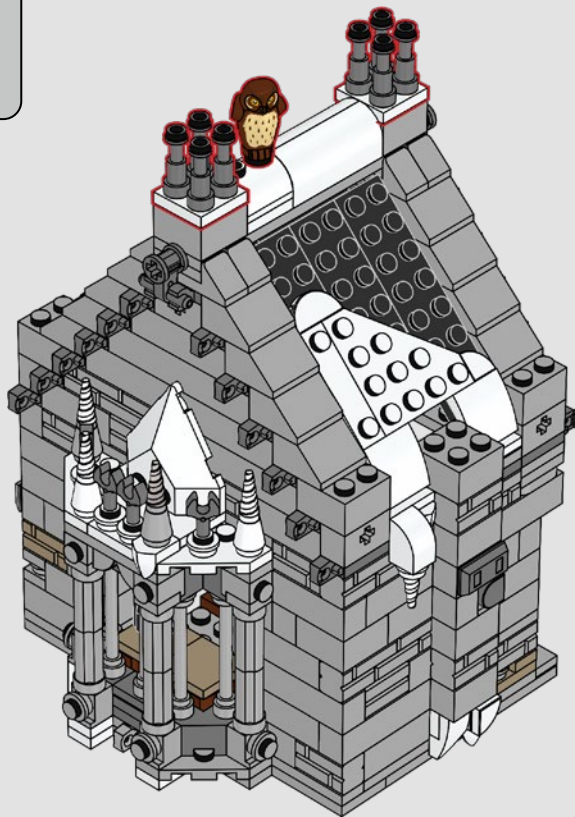

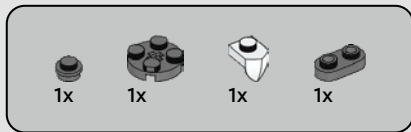

1156

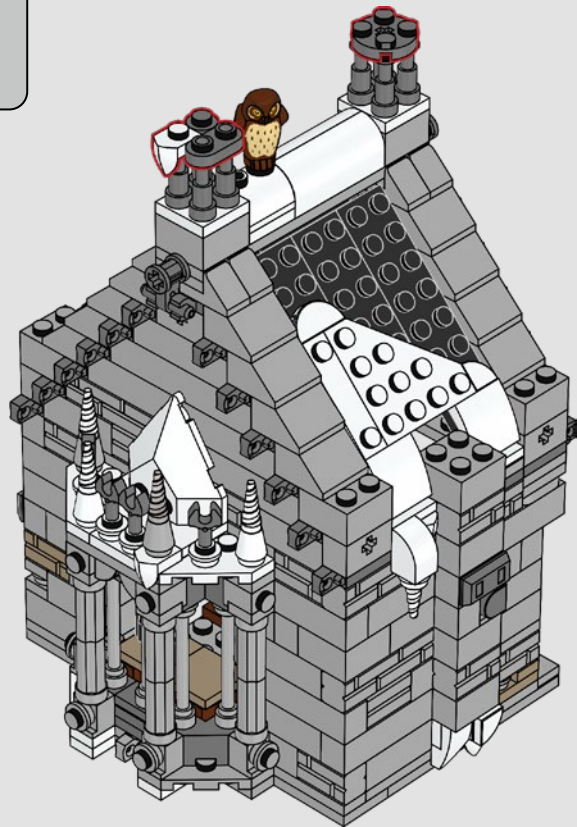



2x

1157

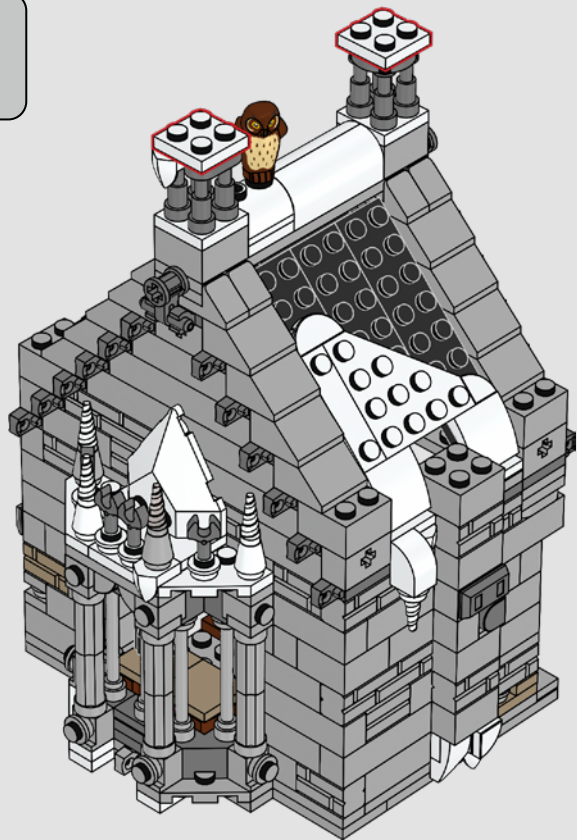

1026

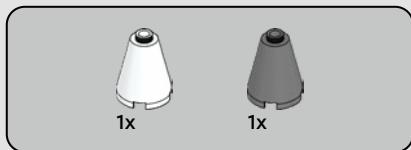

1158

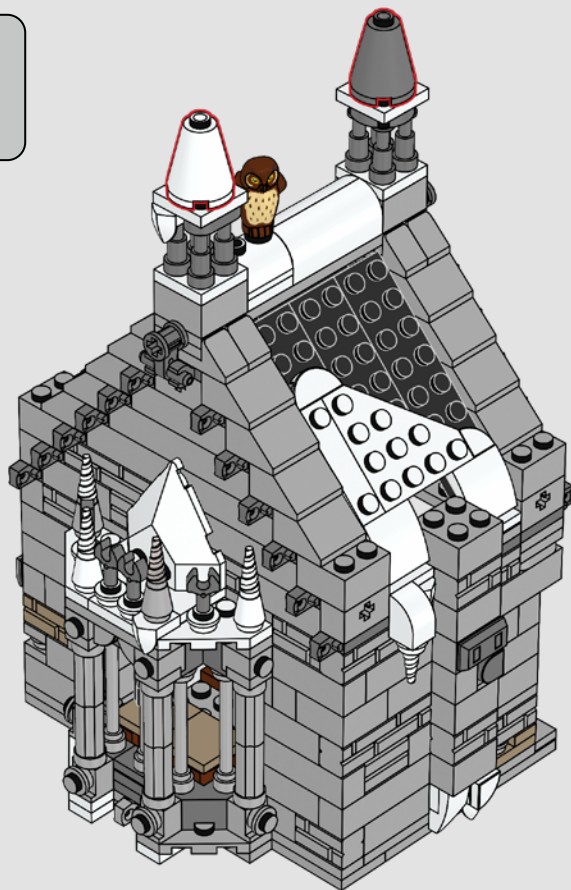

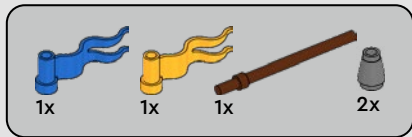

1159

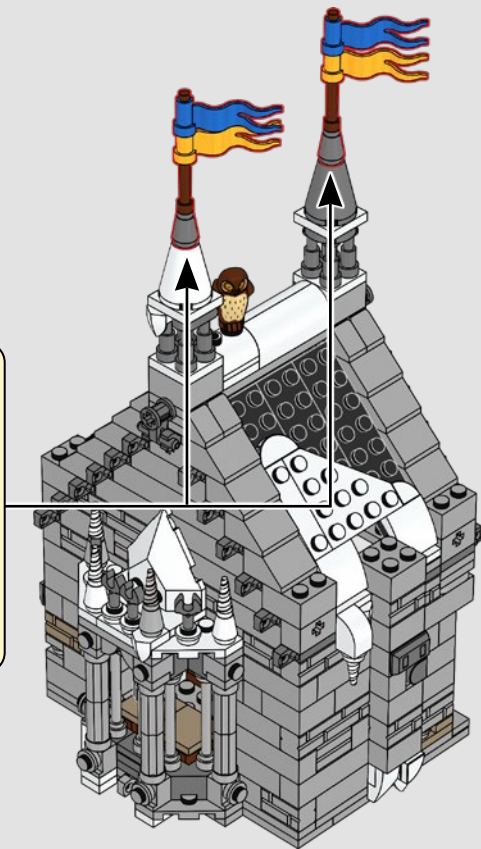
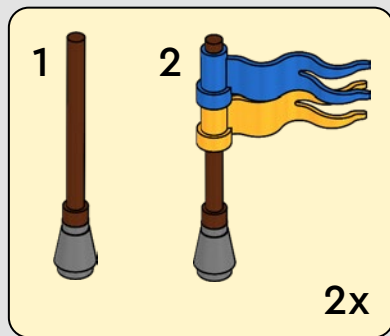



2x

1160

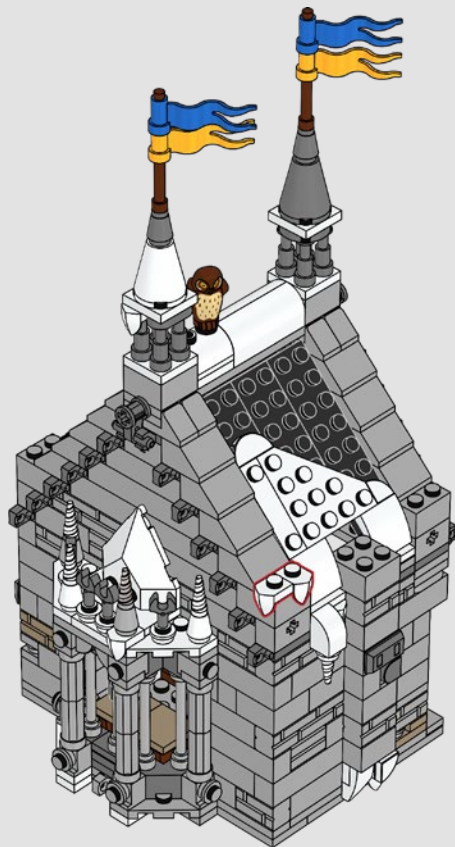

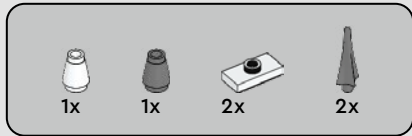

1161

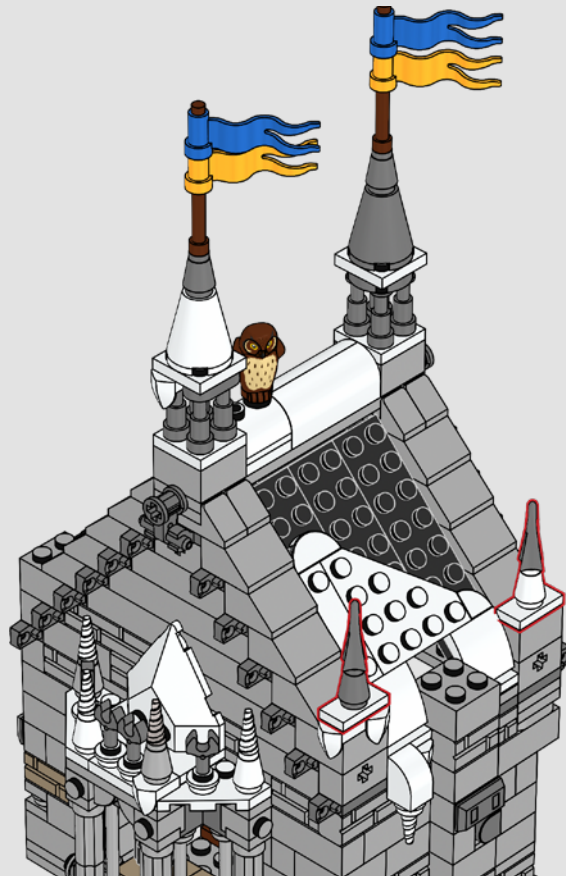

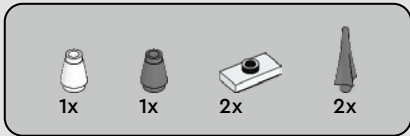

1162

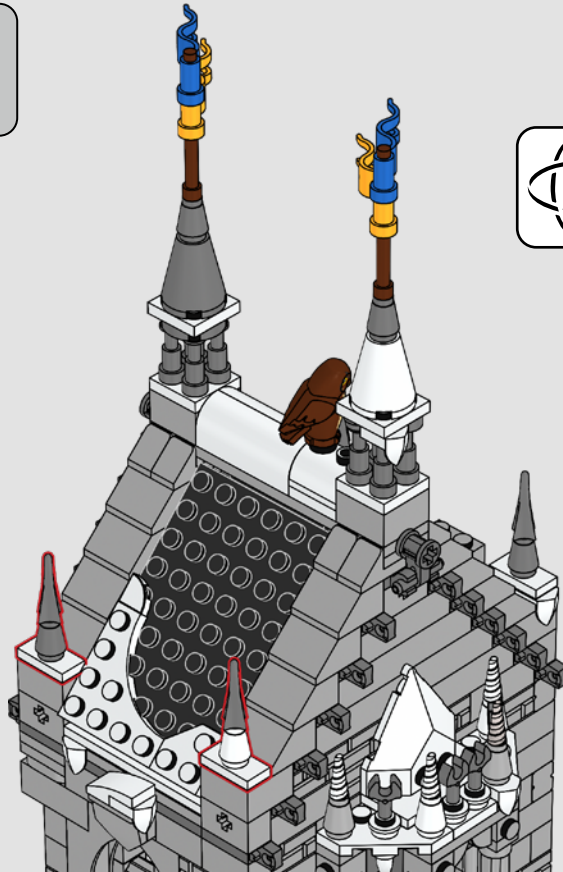
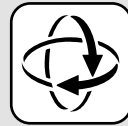



1x



1x

1163

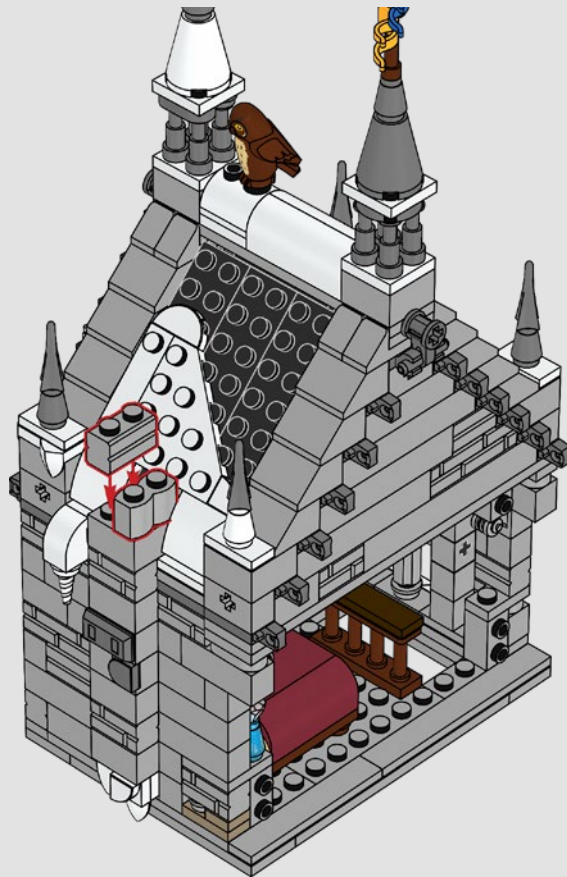



1x



1x



1x

1164

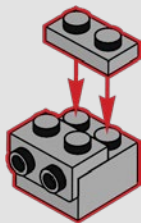

1x



1x

1165

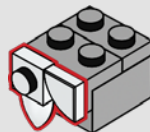

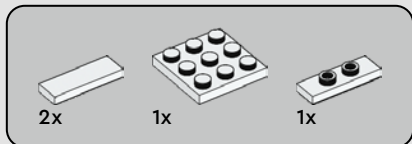

1166

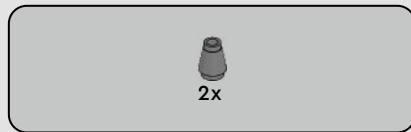
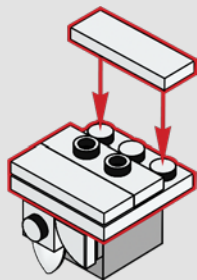

1167

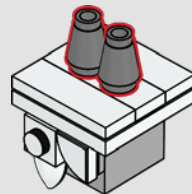

1168



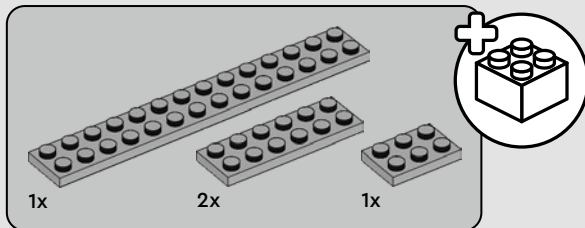
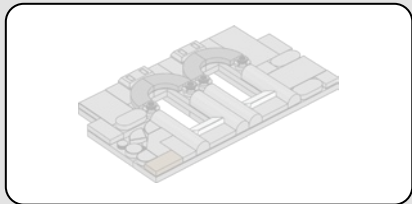

1169

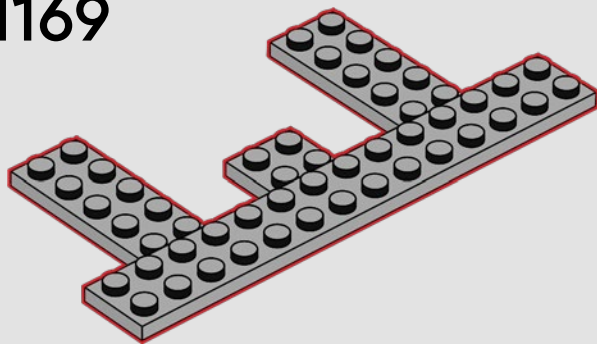

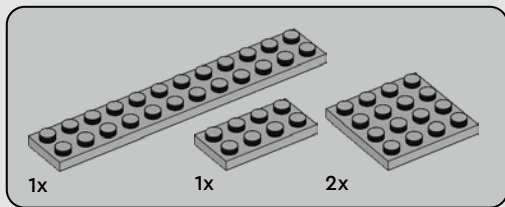

1170

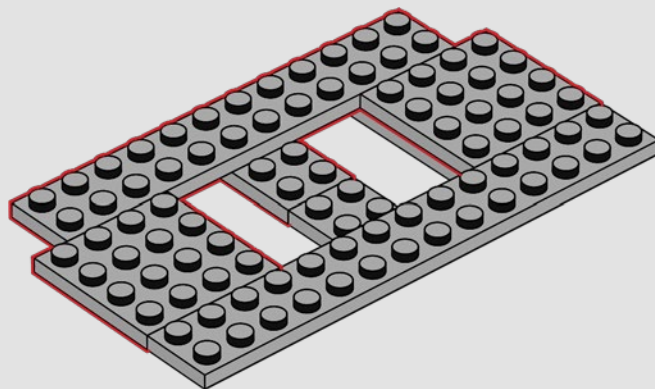

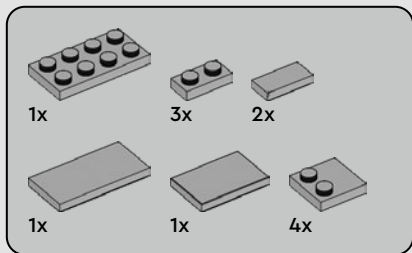

1171

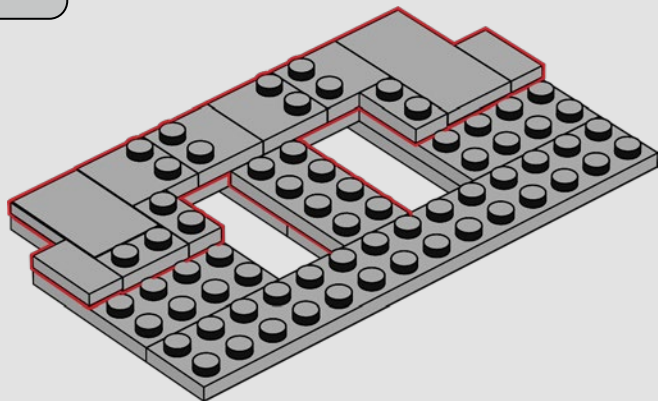

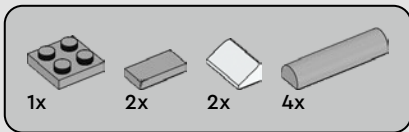

1172

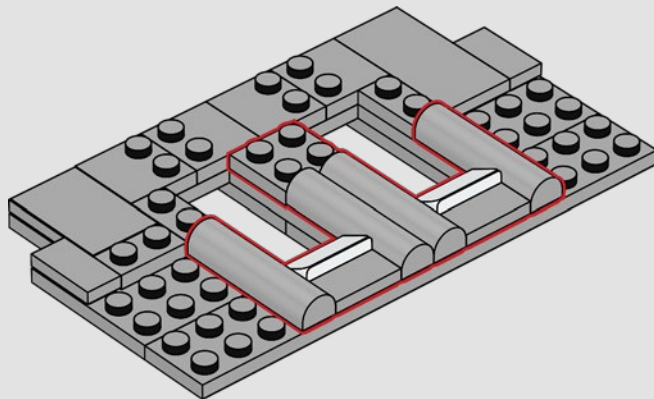



2x



4x



4x

1173

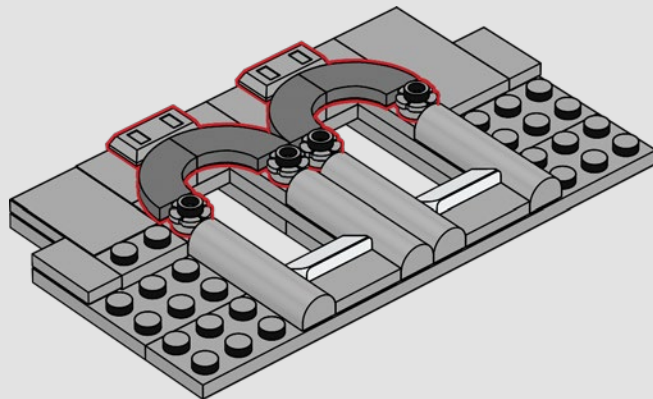

1175



1042

























































































1176





1177

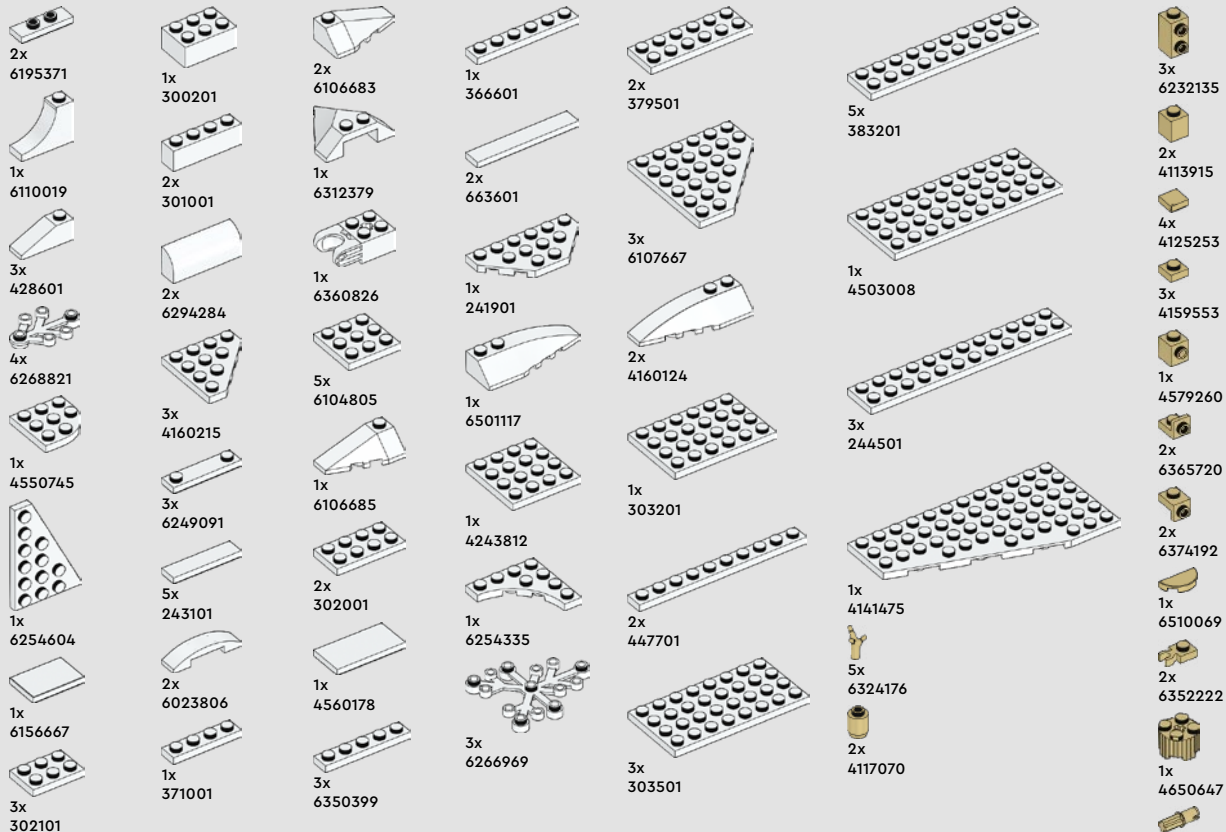

1044

 11x 6192793	 1x 654101	 1x 6296132	 4x 4160857	 1x 6281990	 3x 6285777	 1x 4249563	 1x 4209005	 5x 6058329
 1x 6270106	 26x 307001	 2x 4626882	 3x 4179874	 1x 6166894	 10x 4121932	 1x 6217875	 1x 4209005	 1x 4494474
 2x 6234807	 19x 6258135	 1x 4111971	 4x 6213881	 10x 6051511	 1x 6248827	 5x 6181319	 3x 6168612	 3x 6047220
 6x 4518400	 23x 6172366	 1x 6132824	 2x 6330191	 13x 6034044	 1x 6218823	 3x 6269074	 2x 6056447	 1x 306801
 16x 6168642	 23x 4504369	 7x 4224792	 1x 4161326	 1x 370001	 3x 4515370	 1x 4287707	 7x 302201	 1x 303901
 4x 6284572	 14x 302401	 6x 6132203	 1x 4161326	 1x 446001	 1x 6383982	 1x 4287708	 1x 4624989	 5x 362301
 4x 6206149	 3x 6213880	 5x 6510068	 1x 6334236	 15x 302301	 2x 6346616	 1x 4287708	 6x 6378417	 12x 4249112
 1x 6186681	 1x 300501	 5x 6132204	 6x 4547489	 2x 6069002	 1x 6046384	 1x 4256097	 5x 242001	 13x 4558168
 1x 6406415	 1x 407001	 1x 6392746	 1x 6044601	 15x 306901	 1x 6070698	 1x 4256097	 2x 6218822	 7x 245001
 4x 6250591	 34x 6046905	 1x 6392746	 1x 6044691	 3x 6176240				 11x 6357598
 1x 6052864	 2x 6315564							



 2x 4140562	 2x 6330903	 3x 4113916	 2x 6194724	 1x 6352820	 1x 6310246	 1x 614126	 4x 4504382
 3x 4124456	 4x 6046924	 1x 6431999	 4x 6333512	 1x 6205341	 3x 371024	 4x 6186675	 2x 6344245
 1x 6214334	 1x 6055783	 1x 6030266	 4x 6129747	 1x 4584727	 1x 301024	 3x 6168646	 5x 6173105
 1x 6024495	 2x 4114084	 1x 403221	 6x 6335192	 1x 6099581	 1x 300924	 6x 6332148	 8x 6335317
 6x 4109995	 2x 6469454	 1x 6351814	 6x 6268955	 2x 6348056	 1x 300924	 1x 6454719	 4x 6380236
 7x 4113917	 1x 4121921	 1x 6405989	 1x 6312495	 3x 4624985	 2x 300824	 1x 4290713	 1x 6349966
 1x 4114026	 1x 4162465	 1x 614123	 1x 6288000	 1x 407024	 6x 6210496	 1x 6088585	 1x 4298619
 2x 6391523	 1x 4582437	 2x 6302961	 1x 6384076	 2x 4121625	 4x 4505757	 2x 6172383	 1x 4177431
 1x 6174925	 6x 4113233	 1x 6414960	 1x 6223923	 1x 6206240	 3x 6056234	 6x 6228987	 1x 6371584
 1x 6360029		 2x 6299413	 1x 6384570	 5x 362224		 2x 4558954	 1x 6210270

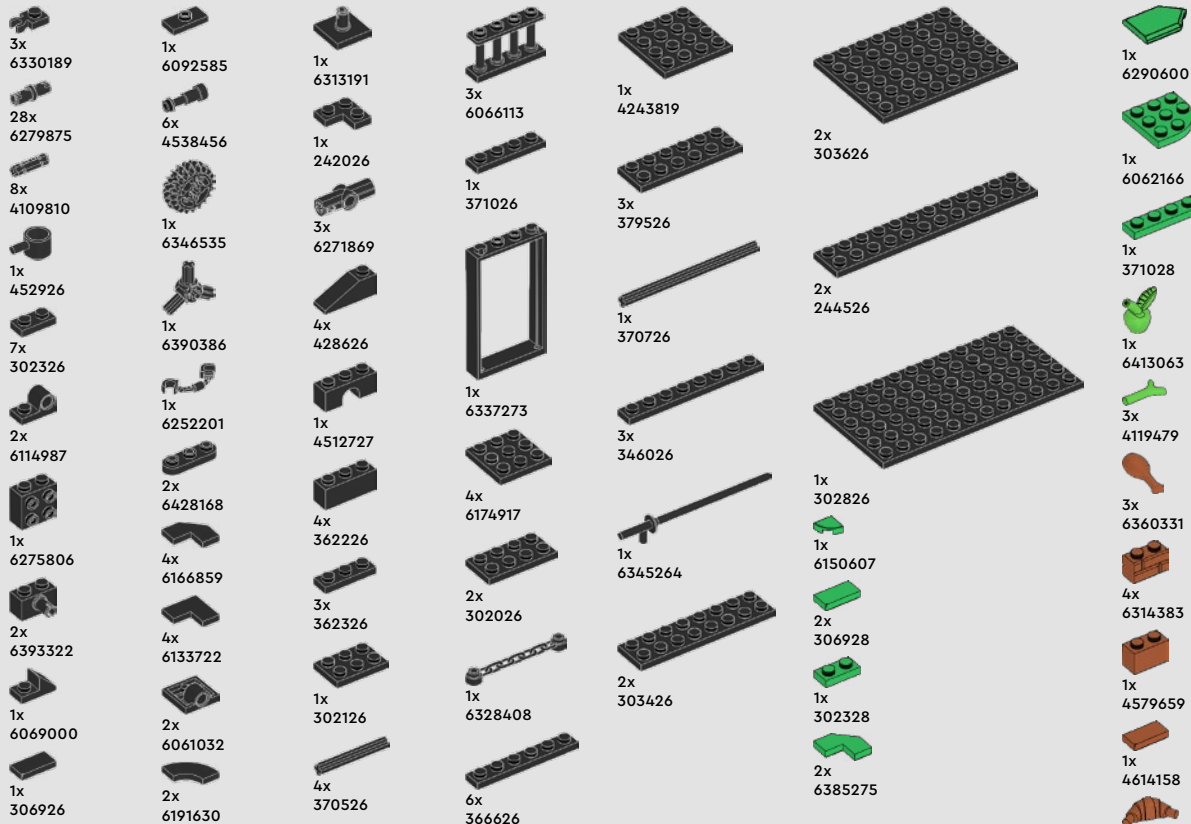



1x
6022079



1x
6247798



1x
6168590



1x
6238677



9x
6252043



1x
6245277



1x
6507865



4x
6292200



12x
6514007



17x
6514224



1x
6373590



1x
6354153



15x
6252049



1x
6301313



3x
6424015

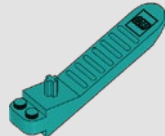

1x
6254100



5x
6300321



5x
6322841



1x
6454725



16x
6001824



4x
4549436



1x
6273590



2x
6245275



5x
6231386



4x
6015449



1x
6226594



37x
4646577



4x
6092591



3x
4528604



3x
4521914



1x
4496699



1x
6101254



1x
6250168



5x
6310830



1x
4550168



1x
4616593



3x
4255416



2x
6126075



1x
4507045



2x
6396392



2x
6093038



4x
6283824



1x
6329820



1x
6001822



1x
4626904



1x
6167936



1x
6175927



1x
6310832



1x
6257599



1x
4247151



1x
6037887



4x
6200659



1x
6331221



1x
6405994



1x
6099189



5x
4521948



2x
6009656



3x
6075617



1x
6406106



4x
6409581



















































































1x
4539090



1x
6335330



2x
6359687

 1x 6186003	 9x 4216581	 1x 6348057	 1x 6278989	 1x 6397820	 1x 6382102	 3x 6428805	 2x 6245259	 6x 6066114
 1x 6089268	 3x 4529242	 2x 4504376	 2x 6035291	 1x 6092590	 1x 4211149	 2x 6316697	 1x 6251470	 4x 4211190
 7x 6357747	 3x 6285623	 2x 6201911	 2x 6075213	 4x 6103004	 4x 6310449	 2x 6280160	 4x 4211152	 11x 6257604
 7x 6314353	 3x 4211183	 1x 6177699	 1x 6102360	 11x 4211151	 2x 6174856	 2x 6425510	 1x 4211220	 1x 6177697
 2x 6292415	 1x 6438899	 1x 6184572	 1x 6092568	 1x 6261359	 2x 6226436	 1x 4565394	 2x 6271128	 3x 4211194
 2x 6096091	 2x 4626196	 1x 4596335	 10x 4211180	 8x 6365885	 1x 6271351	 1x 4211200	 1x 6172636	 2x 4211186
 4x 6393668	 5x 4211242	 2x 6248944	 3x 6078605	 7x 4211150	 2x 6268960	 2x 4520638	 2x 6116613	 1x 4579690
 1x 6345847	 3x 4221744	 8x 6337003	 3x 6172757	 2x 6064188	 1x 6338135	 1x 6102975	 1x 4211189	 1x 6307618
 4x 6240499	 4x 4225469	 1x 6153863	 1x 4270443	 2x 6393936	 6x 6236915	 3x 6261388	 1x 4211181	
	 2x 4211288							



1x
6254220



1x
4533101



1x
4211185



11x
6170468



3x
4221590



7x
4211204



4x
4655611



1x
4609635



1x
6270119



1x
4211247



2x
4277751



1x
4216945



4x
4585337



2x
4271874



1x
6022359



1x
4217848



1x
4211207



1x
4223729



1x
4222627



1x
6246843



3x
4225700



26x
4211525



9x
6168647



4x
6343322



1x
6284071



4x
4211412



11x
6258831



3x
6250597



6x
4211483



99x
4211389



25x
4211476



56x
4211399



42x
4225242



6x
6061702

7x
6401023



3x
4521921



4x
4211415



5x
6176433



7x
6262085



2x
6336539



5x
4558953



1x
6258381



1x
6186013



6x
6267495

7x
6335328

2x
6362975



1x
6345639



1x
4213567



1x
6320306



1x
6213644



7x
6345426



3x
6320356



1x
6428494



6x
6335631



5x
6507791

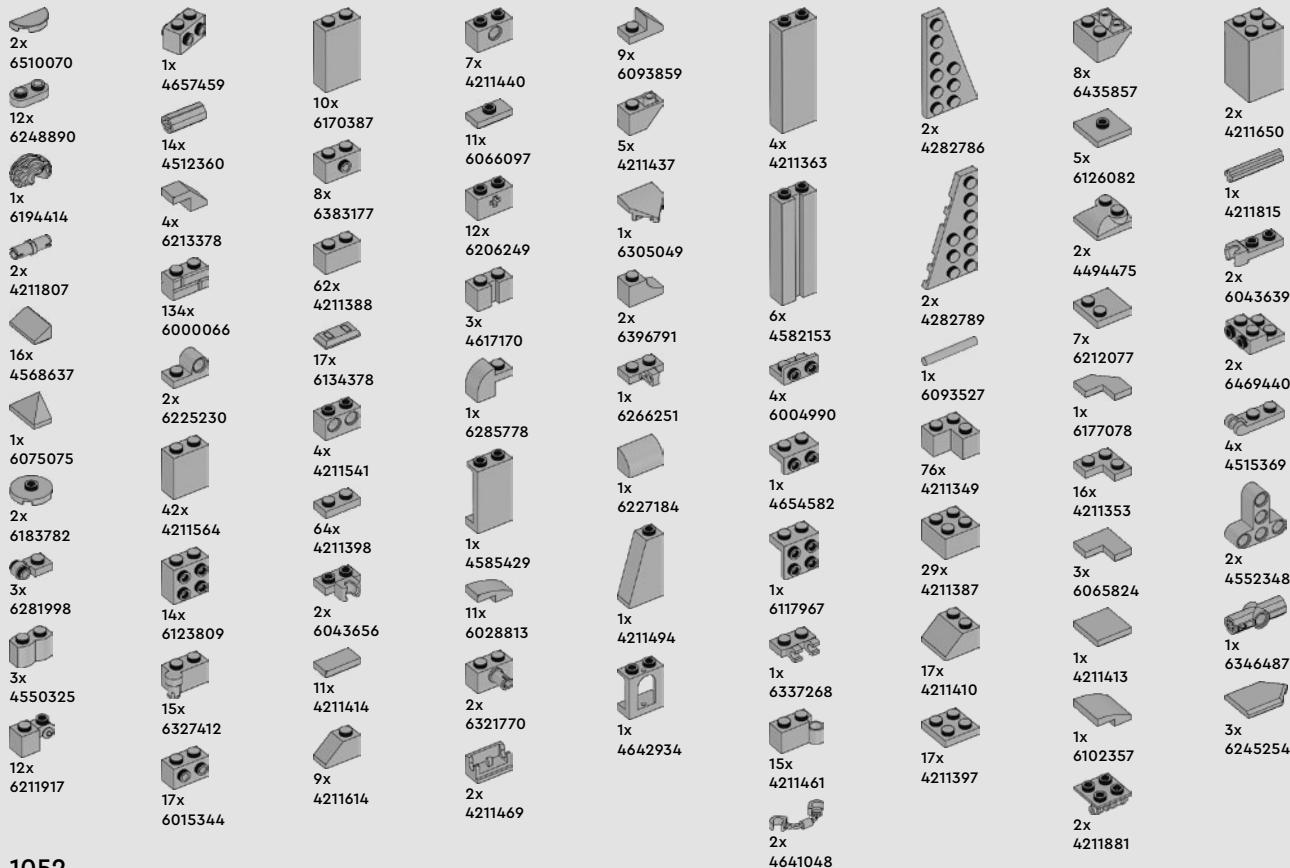

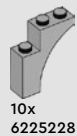

10x
6225228



28x
4211429



164x
4211428



8x
4645397



3x
4211361



3x
4558169



1x
6211969



2x
6329117



1x
4211488



5x
6262083

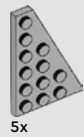

5x
6262082



2x
6116608



19x
4211386



24x
4211396



3x
6171894



77x
4211394



26x
6314891



5x
4211356



22x
4211445



11x
4211435



6x
6403585



5x
6402876



6x
4211636



10x
6257593



2x
6272132



10x
4537056



2x
6015347



5x
4211473



8x
4211385



11x
4211395



7x
4560183



1x
4211409



1x
4597901



2x
4211651



8x
6372029

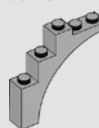

7x
6075066



62x
4211393



6x
4211549



17x
4211438



6x
6106189



1x
6476002

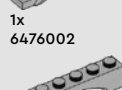

2x
4618874

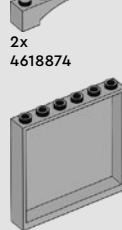

2x
4527174



3x
4243797



13x
4211452

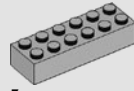

3x
4211795



21x
4211425

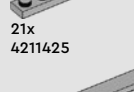

2x
4211481



22x
4211392

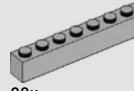

2x
6313653

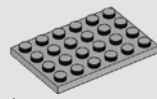

1x
4211404

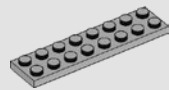

14x
4211406



3x
6037399



4x
6102449

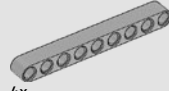

2x
4211474



16x
4251149

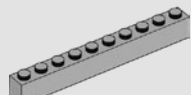

5x
4211521

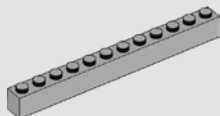

2x
4211522

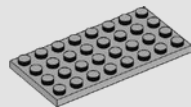

5x
4211407



6x
4514846

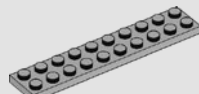

10x
4211462

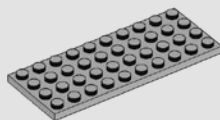

4x
4211402

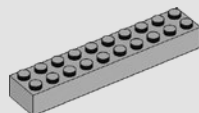

1x
4617862

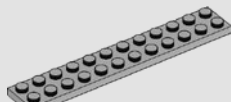

3x
4211360



3x
4211408

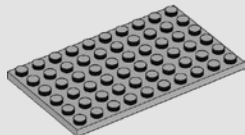

4x
4211405

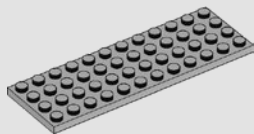

1x
4211401

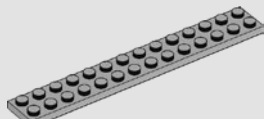

7x
4662161

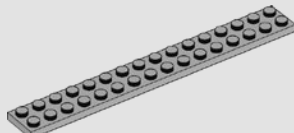

1x
4211486

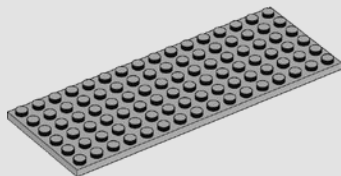

1x
4211733



4x
6269969



6x
6231765



9x
4211090



6x
4529240



8x
4210633



1x
6284596



2x
6271752



10x
6439040



2x
6362252



11x
4210719



4x
6228923



6x
4558955



19x
4211044



22x
4211098



6x
6199549



2x
6388133



1x
4504378



3x
4210639



2x
4210848



1x
6204668



1x
4542586



3x
6321350



2x
6143423



2x
6265669



1x
6390673



1x
6360111



3x
6221607



5x
6388119



2x
4210782



1x
6204667



1x
4210872

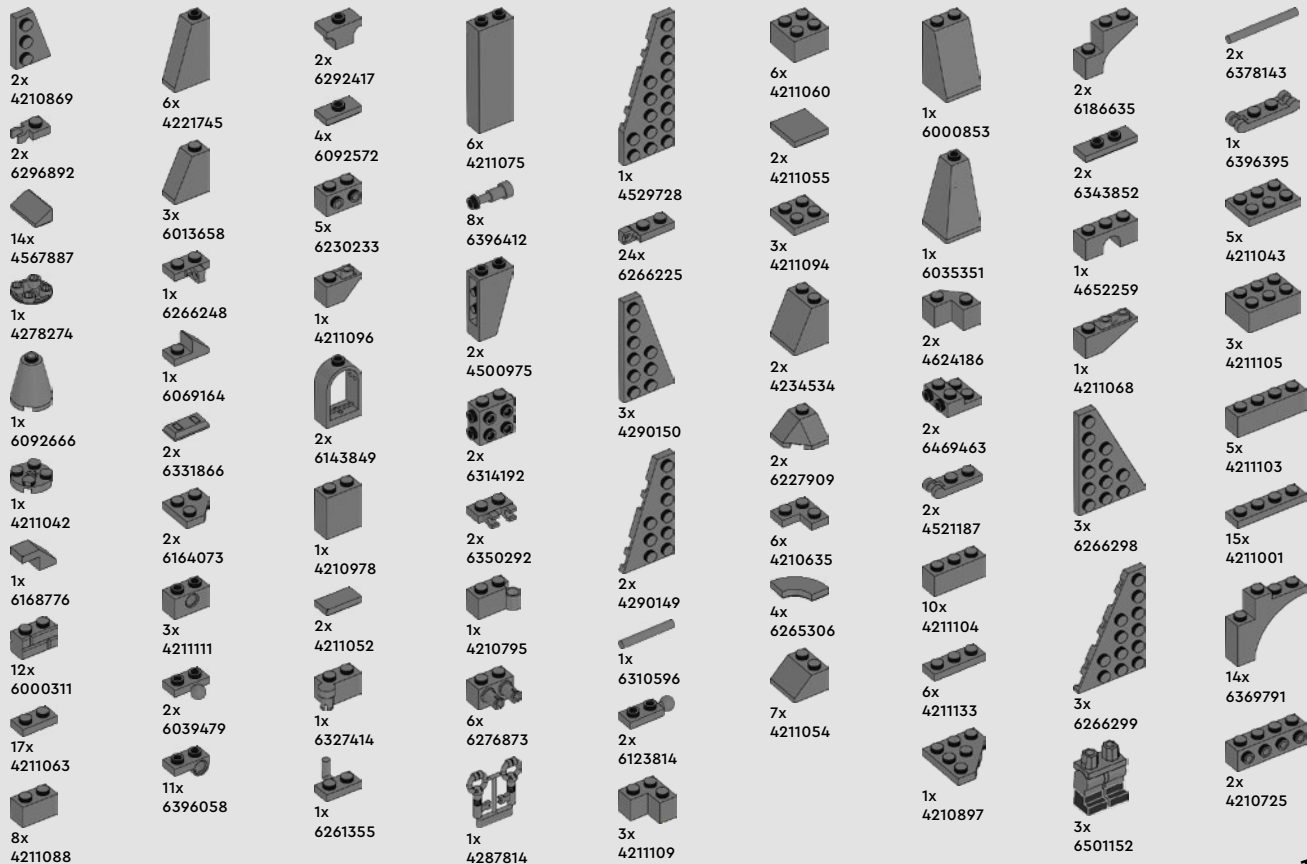



2x
4210999



1x
4210728



4x
6055310



1x
6027686



2x
4213607



2x
4211053



1x
4535930



3x
4210867



3x
6039176



10x
6416526



11x
4211065



2x
4560184



1x
4210866



1x
6121296



1x
6133811



2x
6311445



5x
6172134

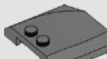

1x
4210940



3x
6106191



9x
4211056



2x
4211100

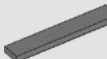

1x
4210651



1x
6476013



1x
6186825



2x
6501125



1x
4243831



2x
4539429



5x
4211002



1x
6528007



3x
4210998

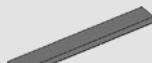

1x
4211008



1x
6313652



2x
4211115



2x
4210997



4x
4211134



3x
4257526



1x
4210678



3x
4210794



2x
6133611



4x
6311438



1x
4211122



5x
4211067



1x
4211114



1x
4210706

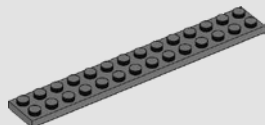

1x
6000970



3x
6258887

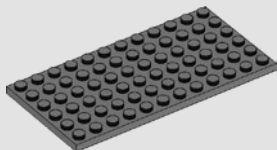

7x
4256149



3x
4210796

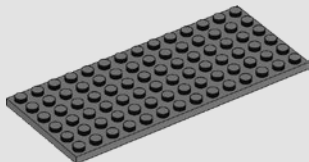

1x
4210720



1x
4523159



1x
6146054



1x
6477142



1x
6173109



1x
6181575



1x
6326425



6x
6315780



3x
6022105



1x
6158322



3x
6278987



1x
6315678



1x
4566688



1x
6347604



2x
6167928



1x
6369856



5x
6313874



2x
6252667



3x
6254792



1x
6226792

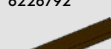

1x
6295366



2x
4518687



4x
6167641



1x
6300103



2x
6167690



1x
6383946



3x
6076674



1x
6336665



1x
6329605



1x
6394960



2x
6037507



2x
6076677



1x
6102984



1x
6214214



1x
6107389



1x
6363149



4x
6363145



1x
6125711



1x
6403581



1x
6403581



2x
6037507



2x
6076677



1x
6248874



2x
6404506



3x
4611885



1x
6327807



2x
6093532



3x
6020190



3x
4611883



3x
6335666



2x
6268844



1x
6037634



3x
6287960



1x
6264993



3x
6410137



4x
6058245



2x
6058242



1x
6285465



1x
6398008



5x
6024722



2x
6268815