



18+

910032

Parisian Street

Designed by Nicolas Carlier

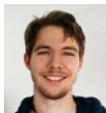

## 910032 Parisian Street

Designed by  
Nicolas Carlier

A big thank you for purchasing my Parisian Street set, your support is invaluable to me! I hope it will give you a little glimpse of the magical atmosphere of Paris and will make you fall in love with the city I was born in!



## Pariser Straße

Vielen Dank, dass du meine Pariser Straße gekauft hast. Deine Unterstützung ist für mich einfach unschätzbar! Hoffentlich vermittelt dir das Modell einen kleinen Eindruck vom besonderen Pariser Flair. Vielleicht verliebst du dich jetzt auch ein wenig in die Stadt, in der ich geboren wurde!

Entworfen von Nicolas Carlier

## Rue parisienne

Un grand merci pour l'achat de mon set Rue parisienne. Votre soutien m'est précieux ! J'espère qu'il vous donnera un petit aperçu de l'atmosphère magique de Paris et qu'il vous fera tomber amoureux de la ville dans laquelle je suis né !

Conçue par Nicolas Carlier

## Strada parigina

Un grande ringraziamento per aver acquistato il mio set Strada parigina... Il vostro supporto è prezioso per me! Spero che vi darà un piccolo assaggio della magica atmosfera di Parigi e vi farà innamorare della città in cui sono nato!

Ideato da Nicolas Carlier

## Calle Parisina

Muchísimas gracias por comprar mi set Calle Parisina. ¡Vuestro apoyo no tiene precio para mí! Confío en que os permita haceros una pequeña idea de la mágica atmósfera de París, ¡y logre que os enamoréis de la ciudad donde nací!

Diseñado por Nicolas Carlier

## Rua de Paris

Muito obrigado por comprarem o meu set Rua de Paris, o vosso apoio é inestimável para mim! Espero que este vos ofereça um pequeno vislumbre da atmosfera mágica de Paris e que vos faça apaixonar pela cidade em que nasci!

Criado por Nicolas Carlier

## 巴黎街景

非常感谢你购买我的巴黎街景套装，你的支持对我来说是无价的！我希望它能让你一瞥巴黎美景，让你爱上我出生的城市！

由 Nicolas Carlier 设计

## Paryska ulica

Wielkie dzięki za zakup mojego zestawu Paryska ulica. Wasze wsparcie wiele dla mnie znaczy! Mam nadzieję, że znajdziecie w tym zestawie namiastkę magicznej atmosfery panującej w Paryżu i zakochacie się w mieście, w którym się urodziłem!

Autor: Nicolas Carlier



bricklink  
designer  
program  
— SERIES 1 —



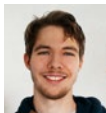

## 910032 Parisian Street

Designed by  
Nicolas Carlier

A big thank you for purchasing my Parisian Street set, your support is invaluable to me! I hope it will give you a little glimpse of the magical atmosphere of Paris and will make you fall in love with the city I was born in!

### Ulice v Paříži

Moc vám děkuji, že jste si zakoupili moji sadu Ulice v Paříži, vaše podpora je pro mě neocenitelná! Doufám, že vám umožní nahlédnout do kouzelné atmosféry Paříže a zamilujete se do města, ve kterém jsem se narodil!

**Autor návrhu: Nicolas Carlier**

### Ulica v Paříži

Veľká vďaka, že si kupujete moju stavebnicu Ulica v Paříži, vaša podpora pre mňa znamená všetko! Dúfam, že vďaka stavebnici nahliadnete do čarovnej atmosféry Paříža a zamilujete sa do mesta, v ktorom som sa narodil!

**Navrhol Nicolas Carlier**

### Párizsi utca

Óriási köszönet, hogy megvásároltátok a Párizsi utca készletemet! A támogatókatok felbecsülhetetlen számomra. Remélem, hogy egy kis bepillantást enged Párizs varázslatos légkörébe, és beleszerettek a szülővárosomba!

**Tervezte: Nicolas Carlier**

### Stradă pariziană

Mulțumesc mult că ai cumpărat setul Stradă pariziană, susținerea ta e de neprețuit pentru mine! Sper că setul îți va oferi o scurtă privire asupra atmosferei magice a Parisului și te va face să te îndrăgostești de orașul în care m-am născut!

**Concept de Nicolas Carlier**

### Parížes iela

Pateicos, ka iegādājies manu Parizes ielas komplektu, tavš atbalsts ir nenovērtējams! Es ceru, ka tas sniegs tev nelielu ieskatu Parizes maģiskajā atmosfērā un liks tev iemīlēties, kurā esmu dzimis!

**Autors Nicolas Carlier**

### Pariisi tänava

Suur aitäh, et ostsid minu Pariisi tänava komplekti, sinu toetus on minu jaoks hindamatu! Loodan, et see annab sulle veidi aimu Pariisi maagilisest atmosfäärist ja paneb armuma linna, kus ma sündisin!

**Kujundanud Nicolas Carlier**

### Paryžiaus gatvė

Didelis ačiū, kad įsigijote mano Paryžiaus gatvės rinkinį, jūsų palaikymas man yra neįkainojamas! Tikiuosi, kad jis leis pajusti magišką Paryžiaus atmosferą ir privers įsimylėti miestą, kuriame gimiau!

**Sukūrė Nicolas Carlier**



bricklink  
designer  
program

SERIES 1

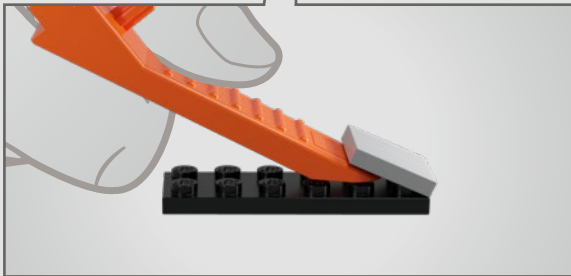
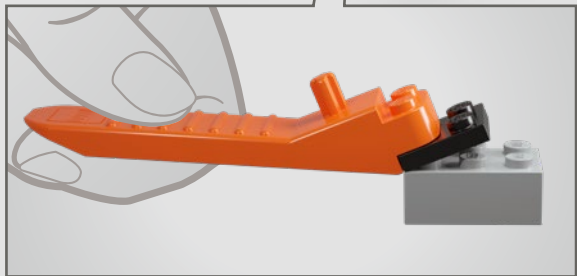
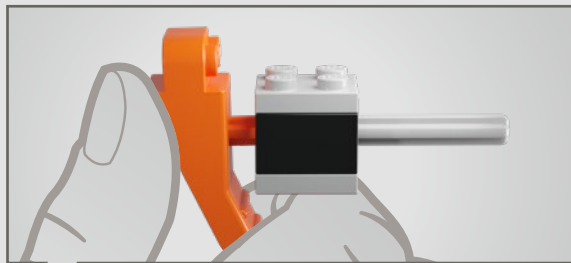



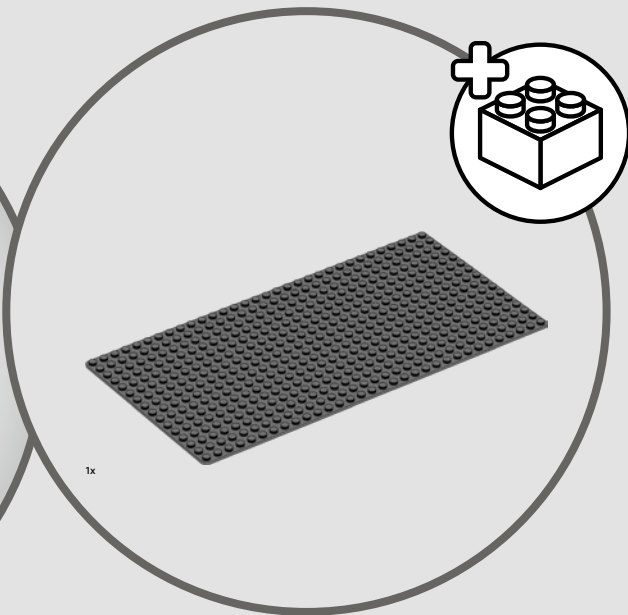



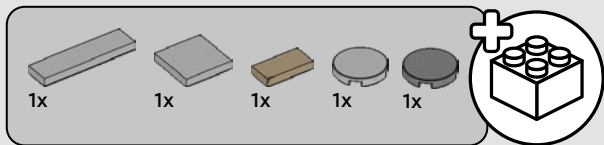

1

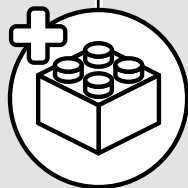
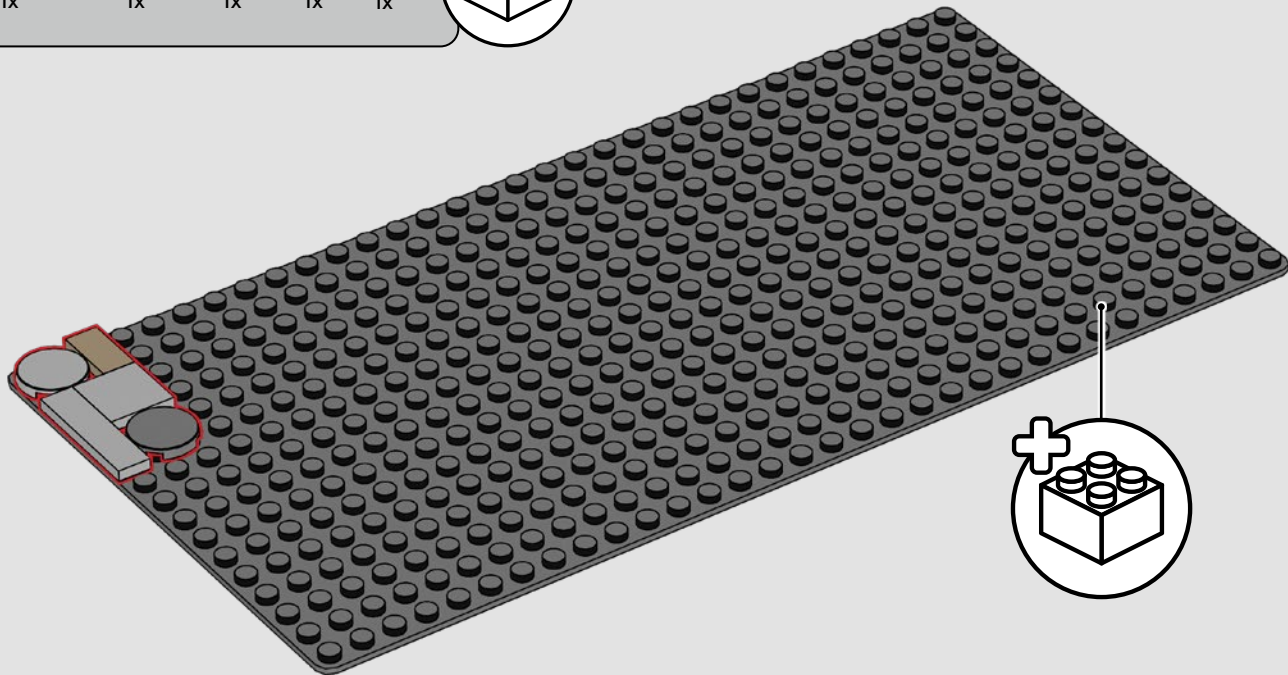

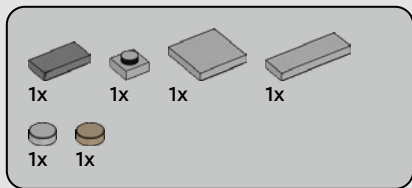

2

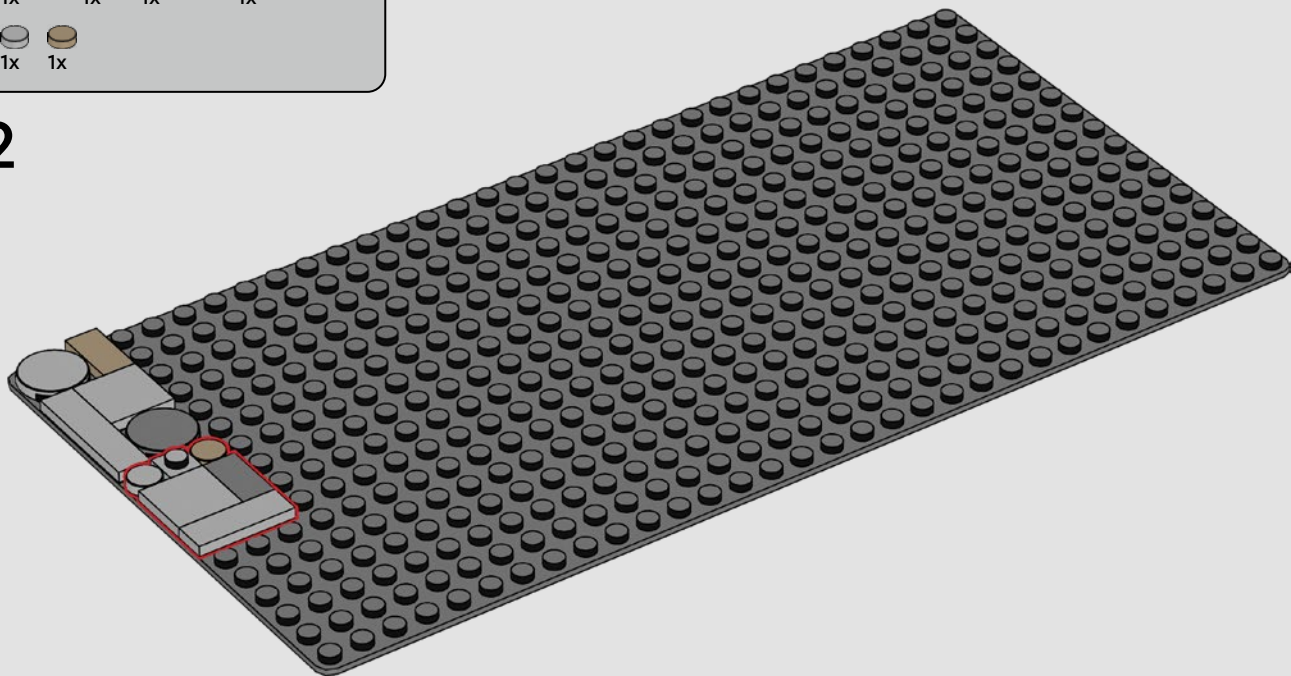

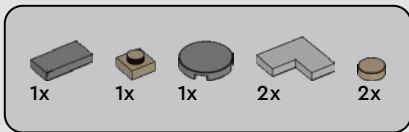

3

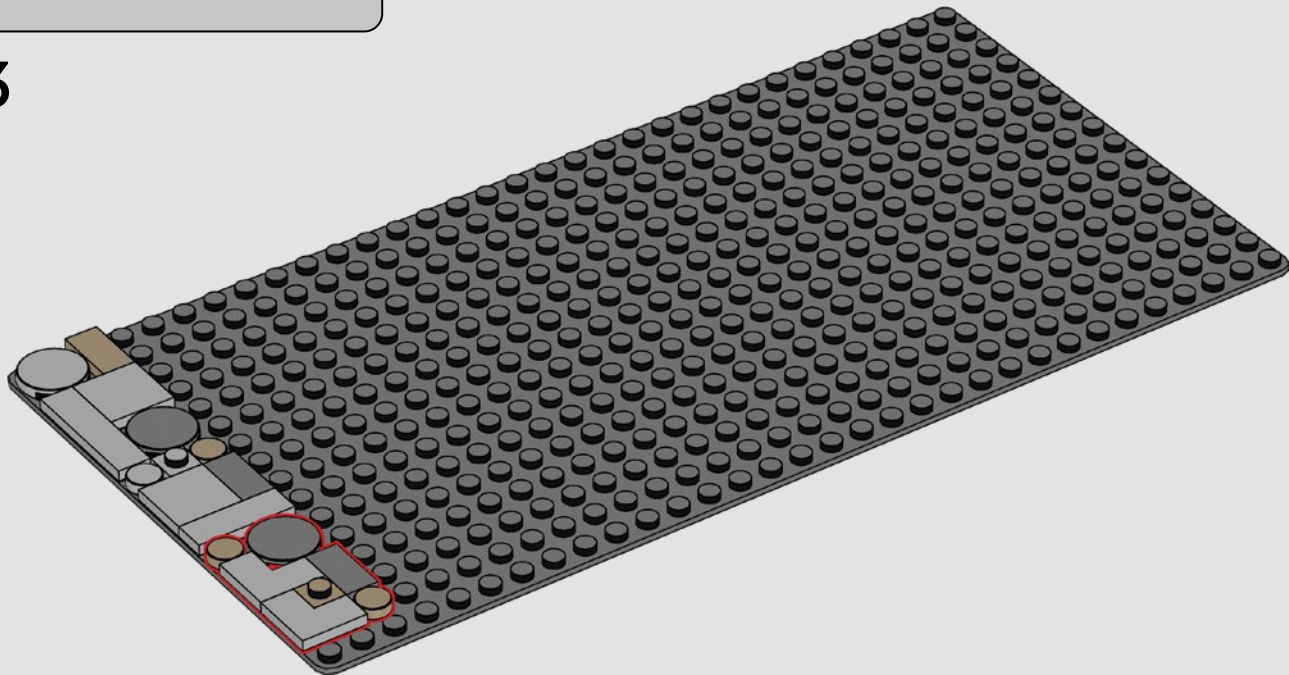

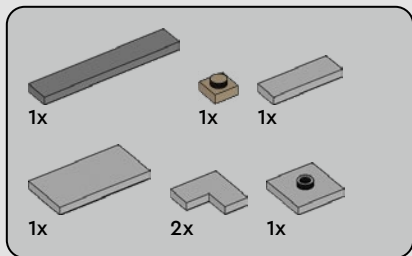

4

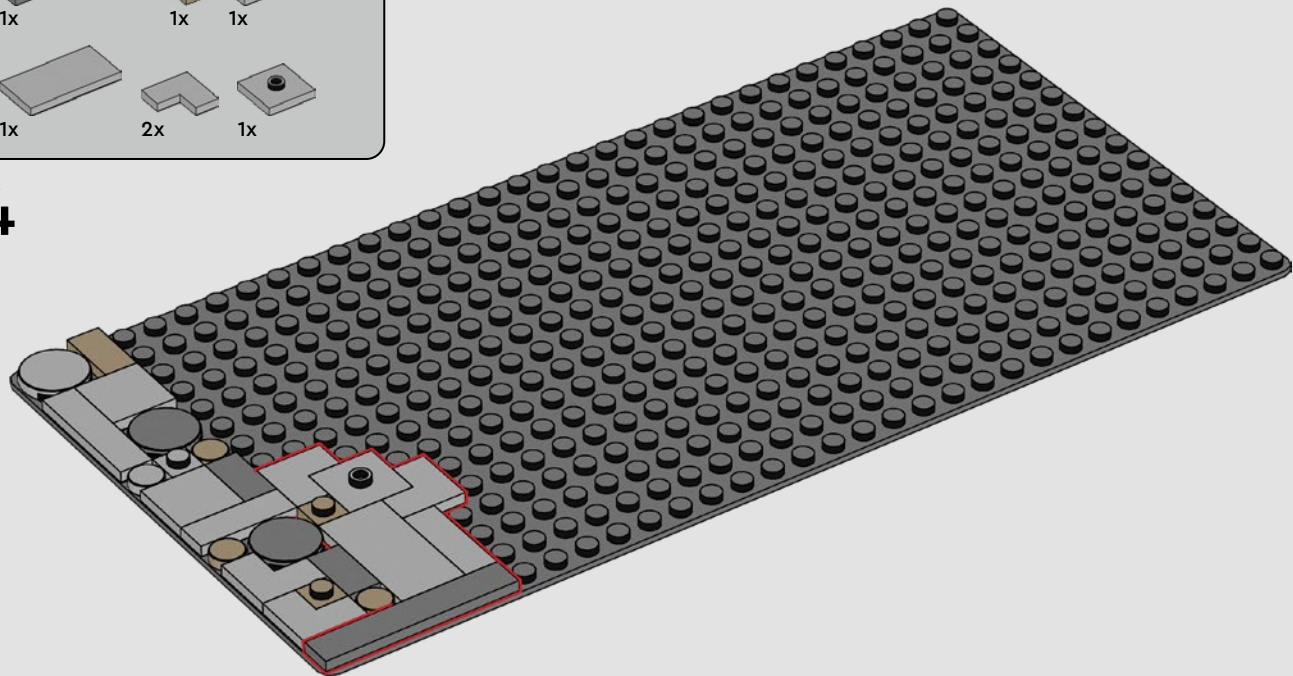



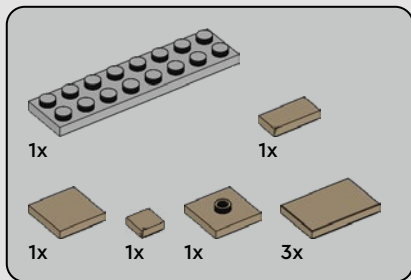

5

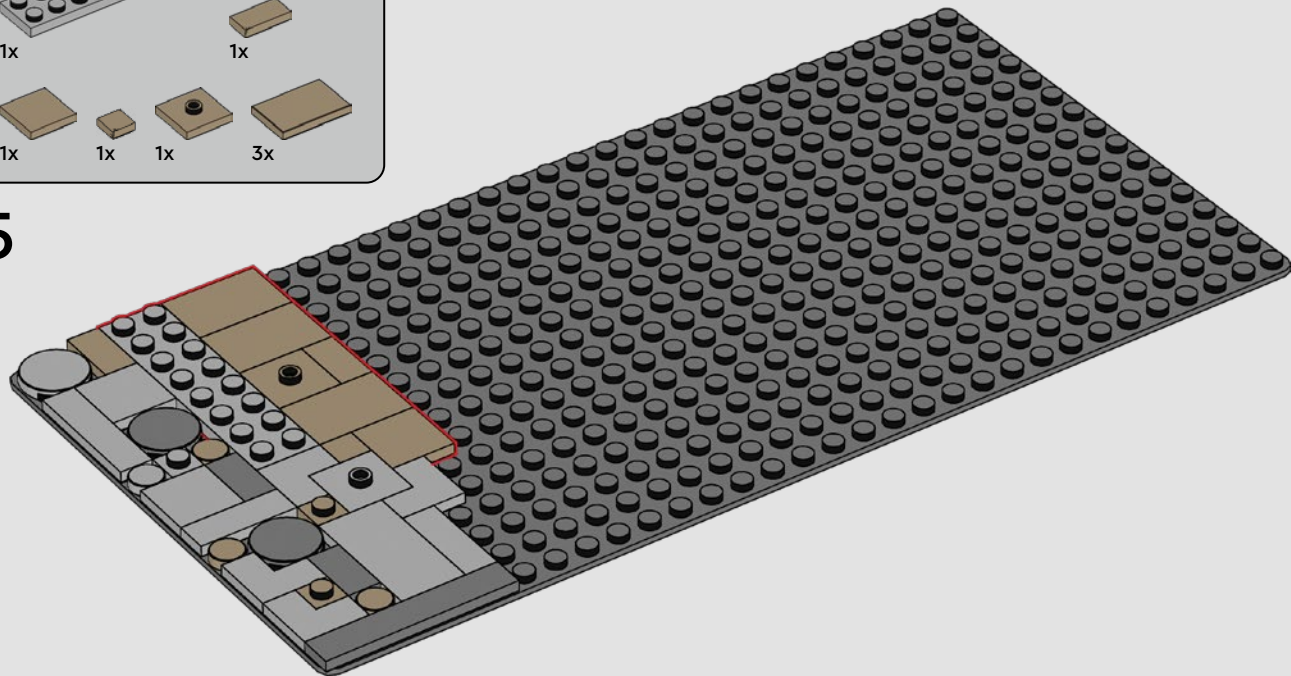

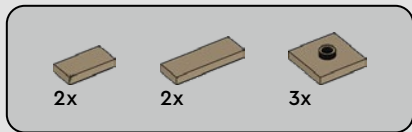

6

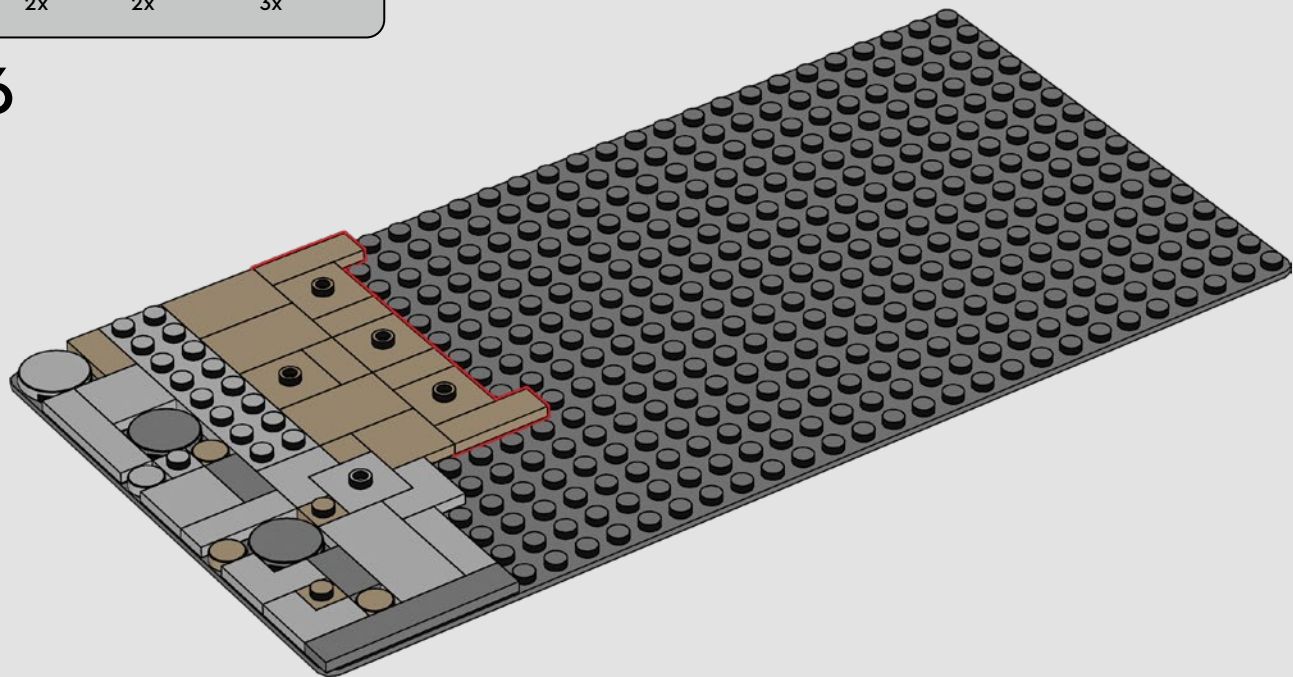

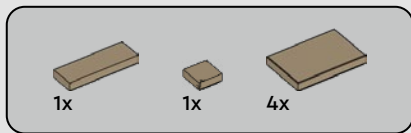

7

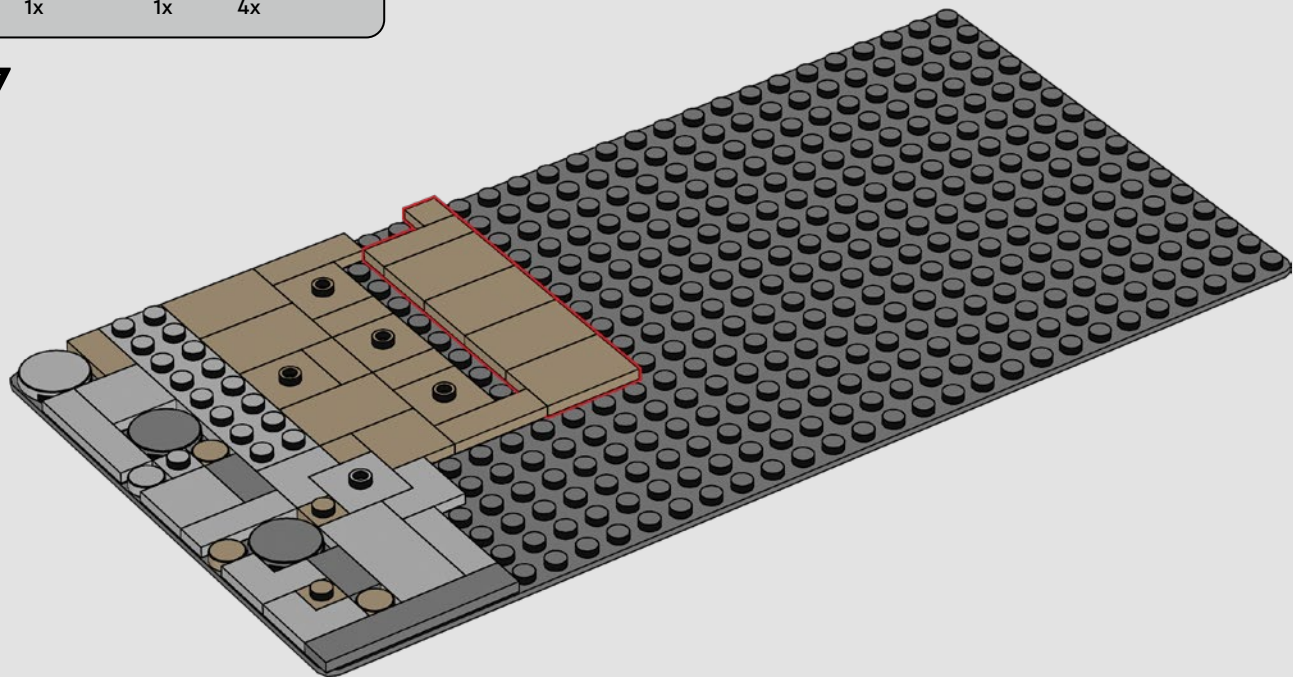

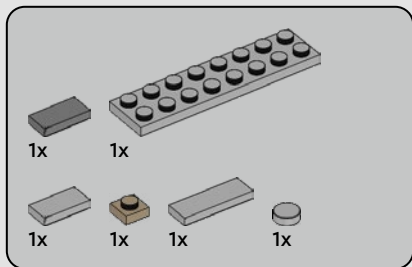

8

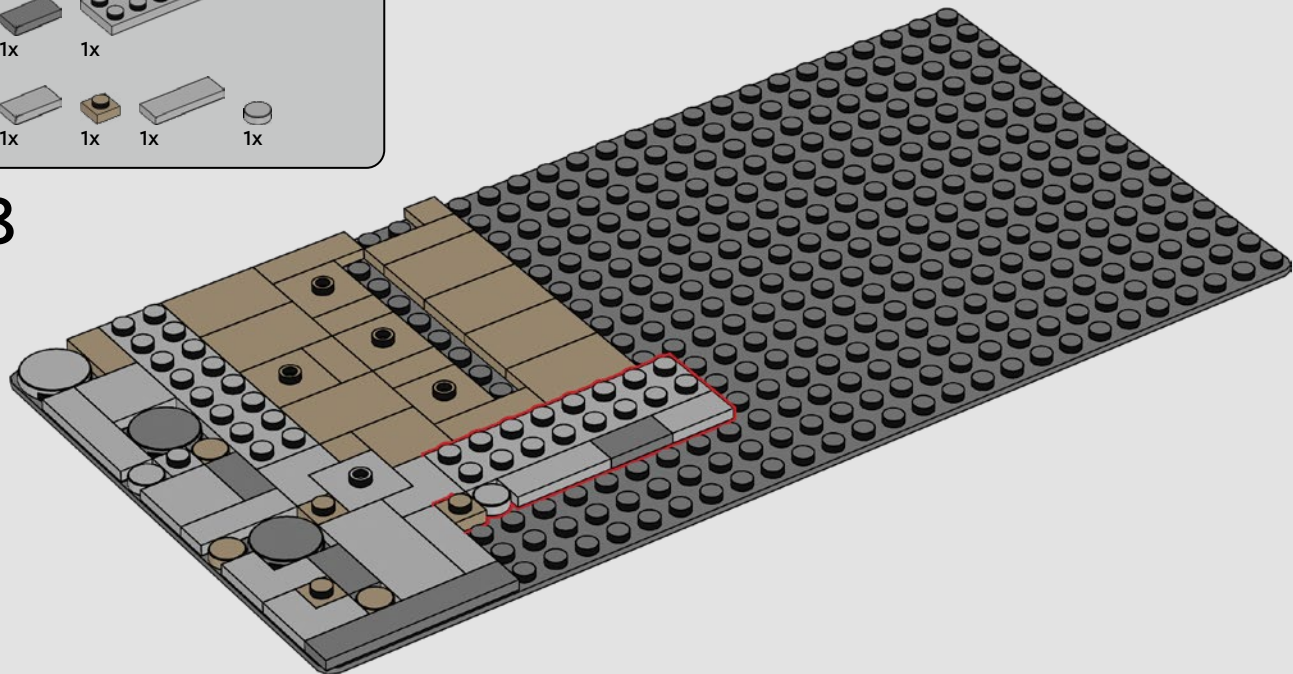



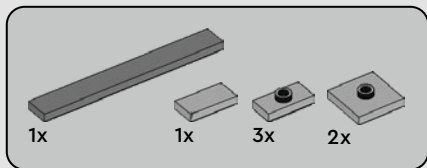

9

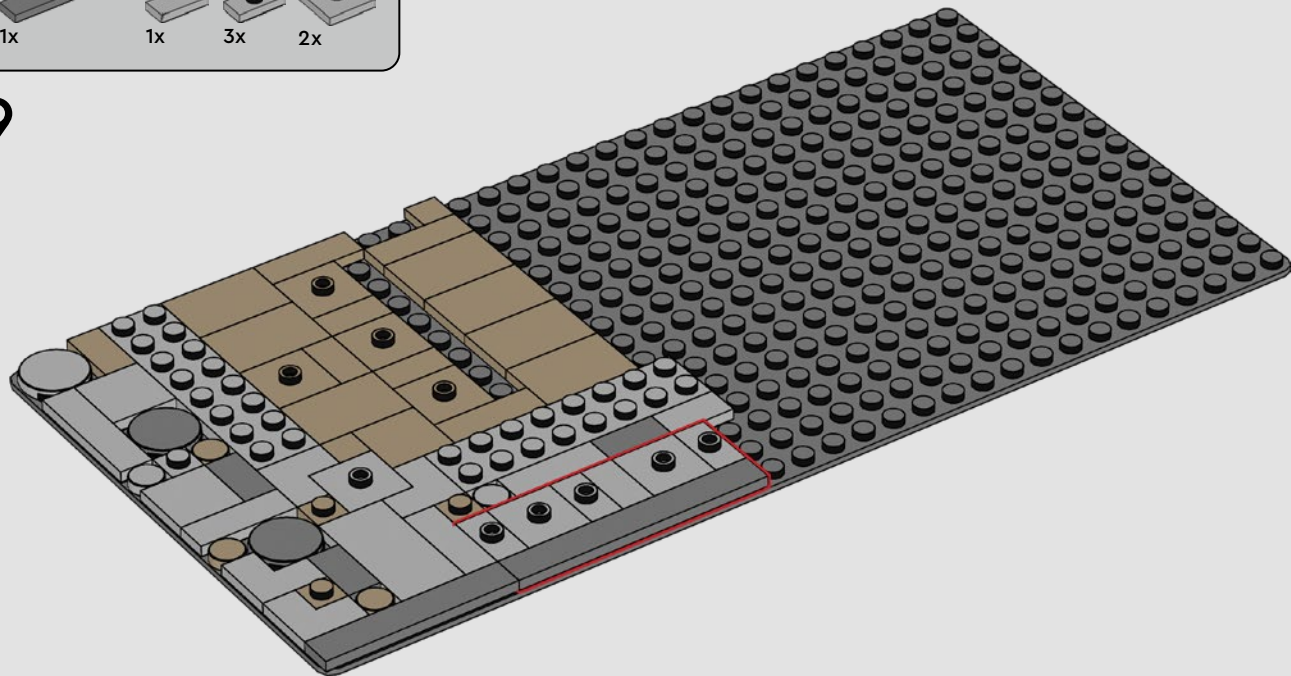

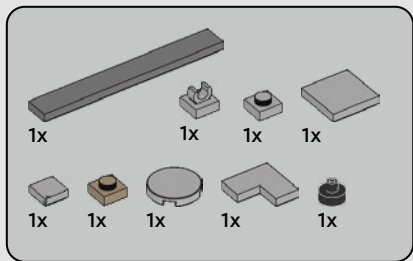

10

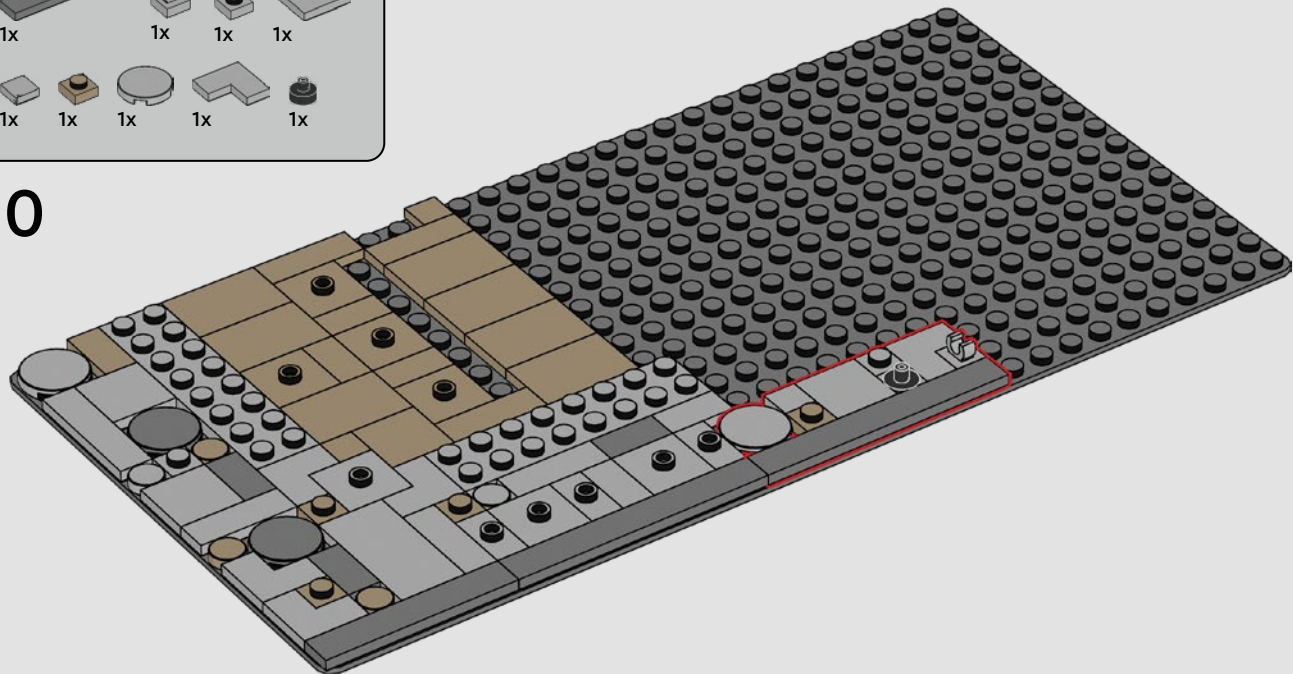

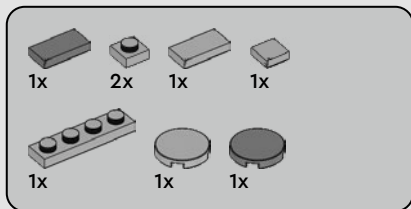

11

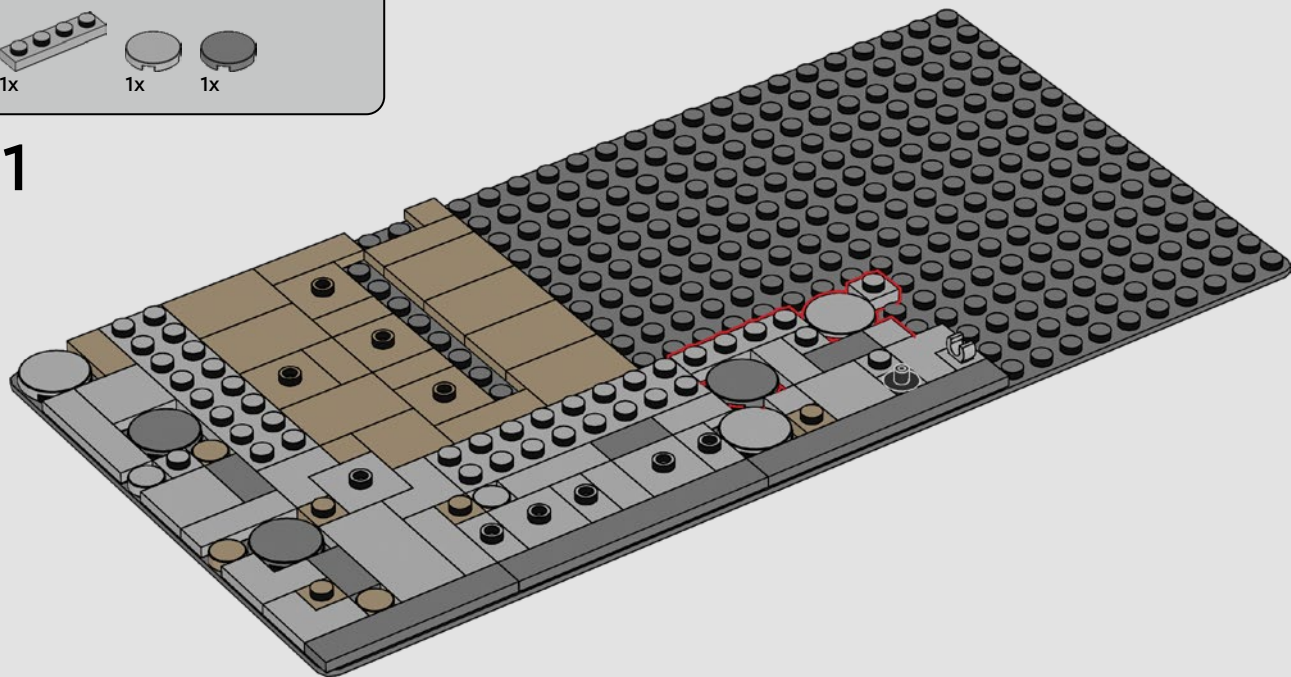

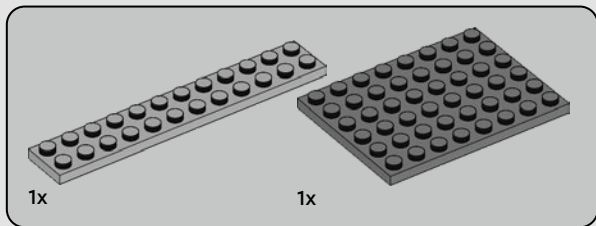

12

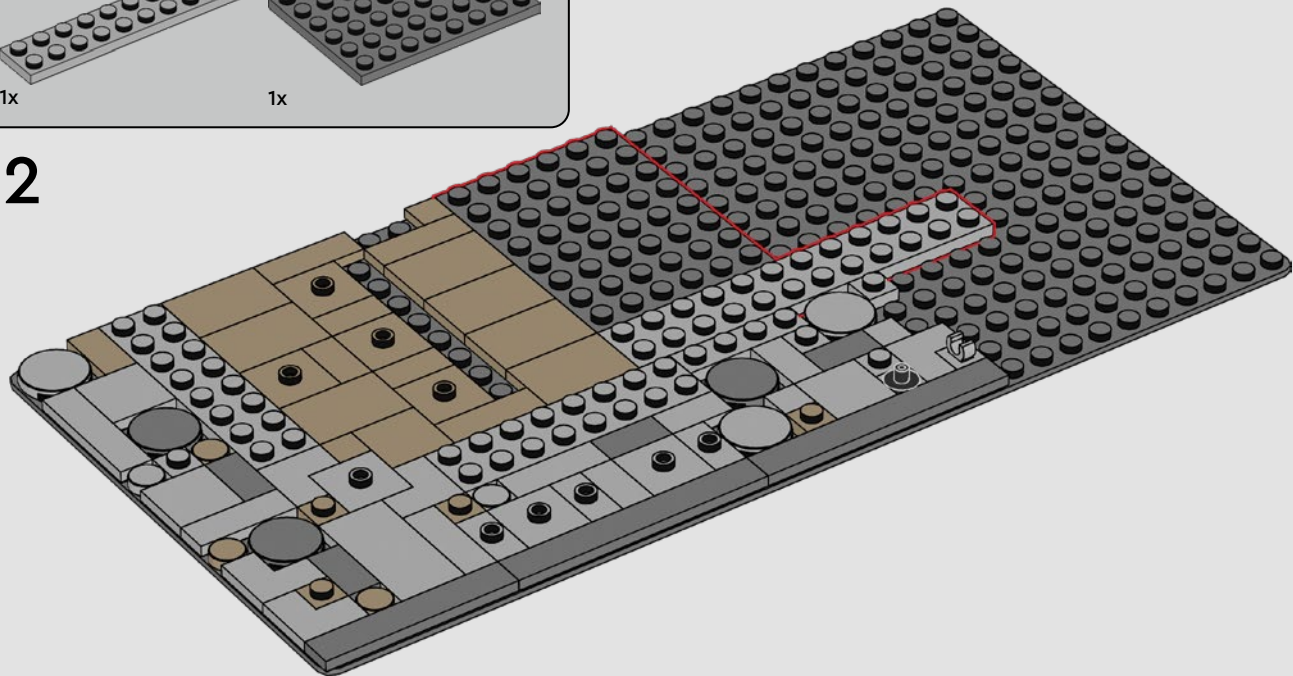





6x



2x

13

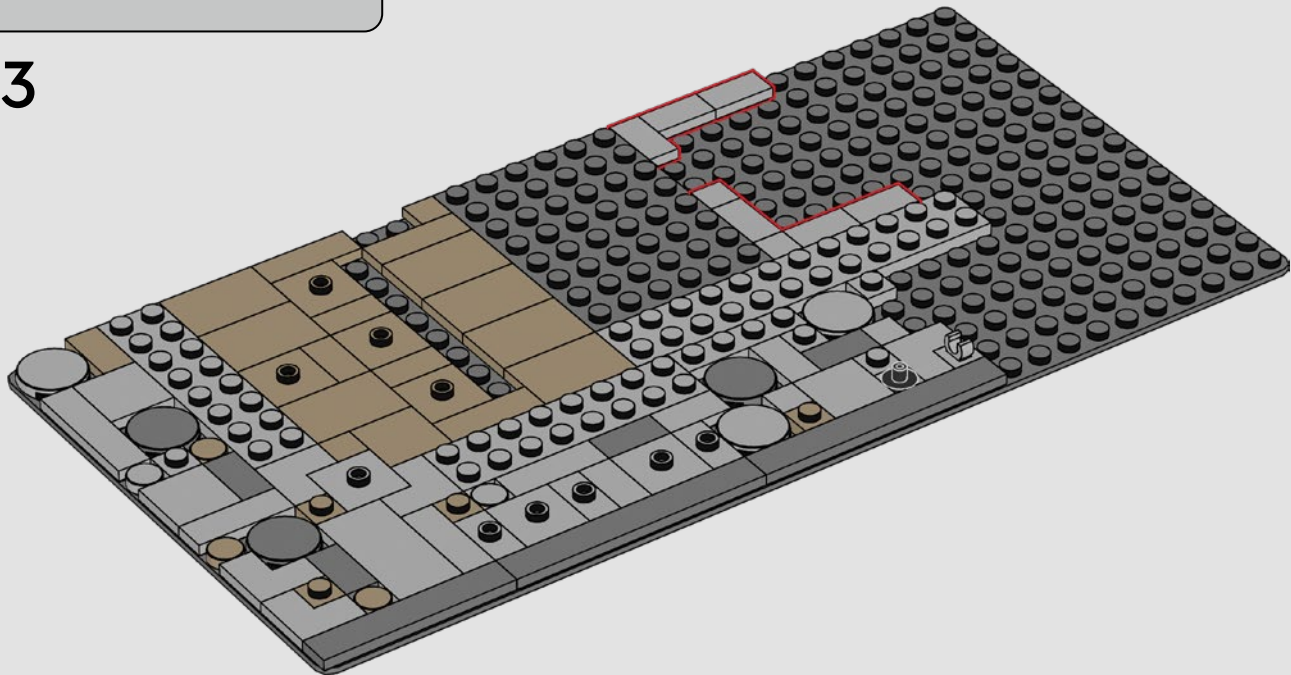

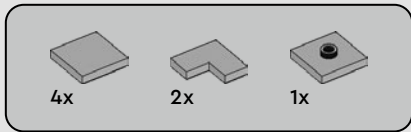

14

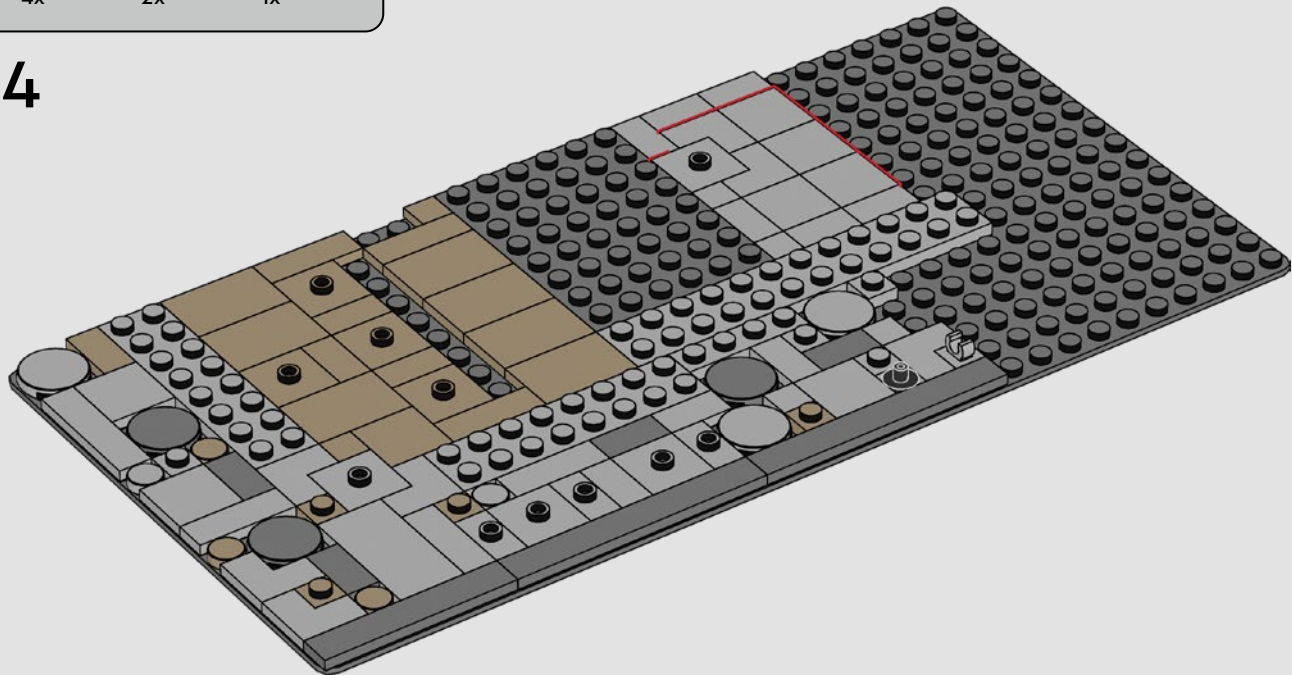

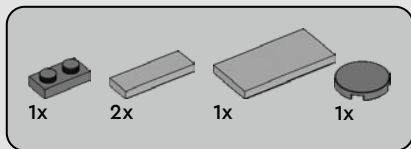

15

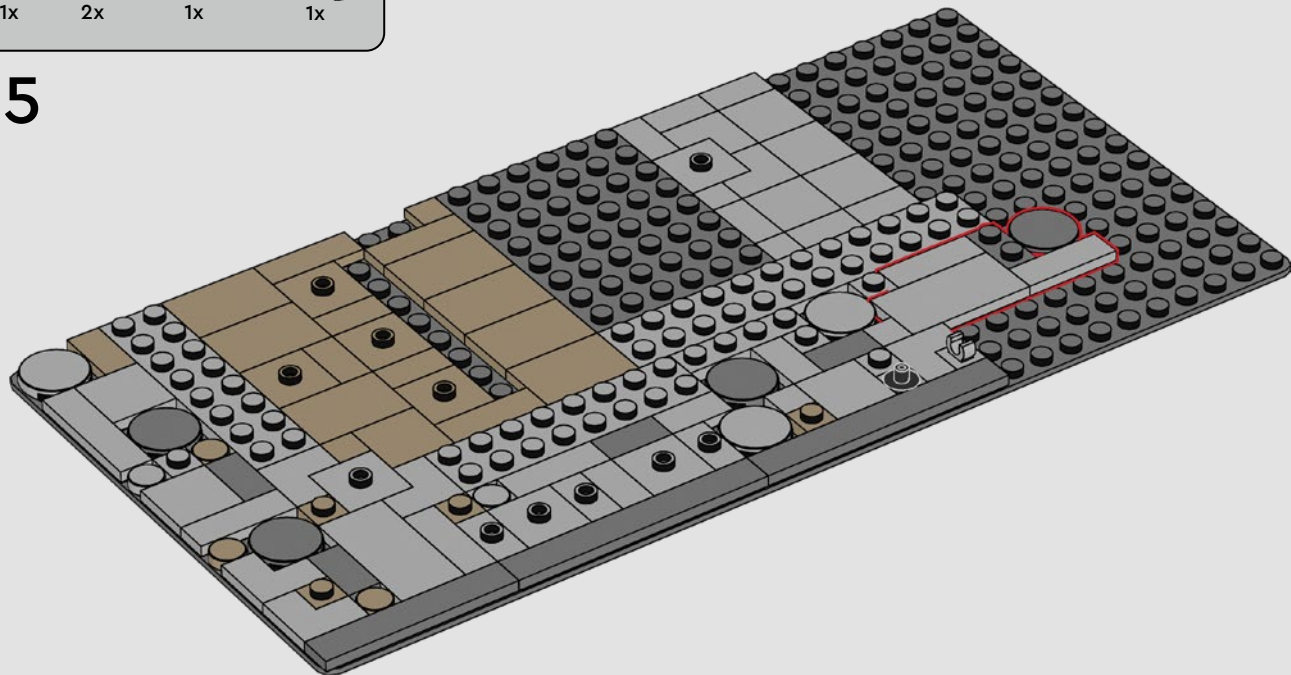

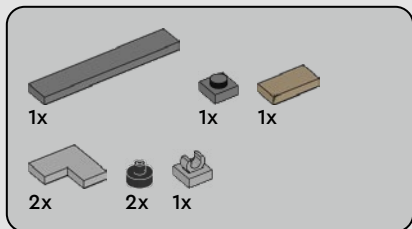

16

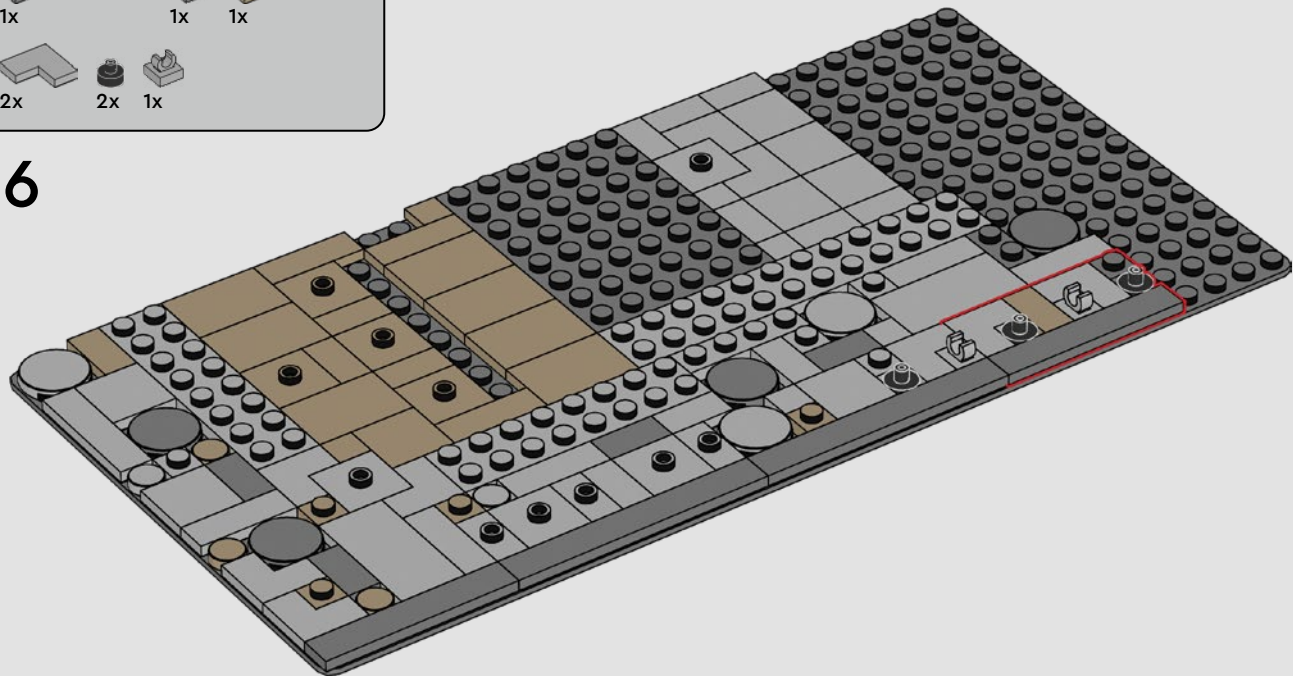

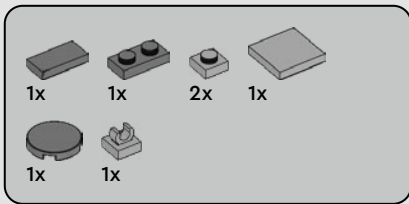

17

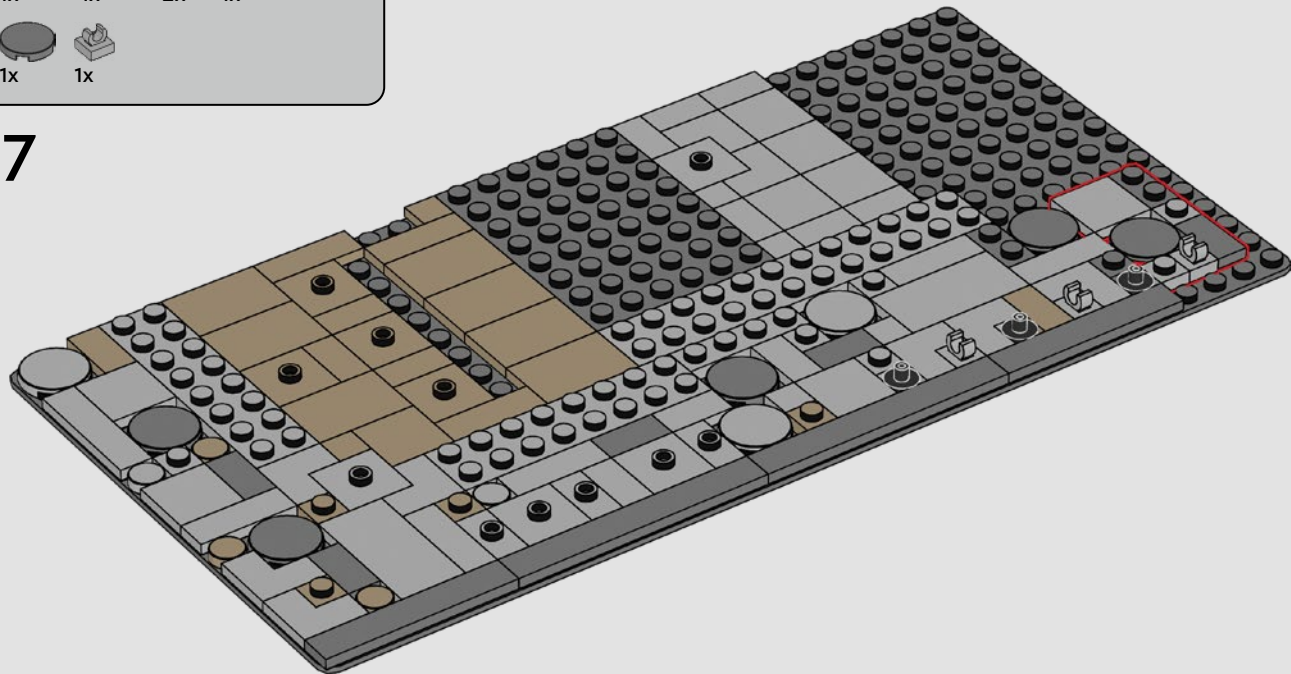

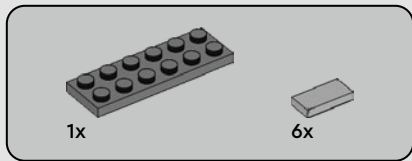

18

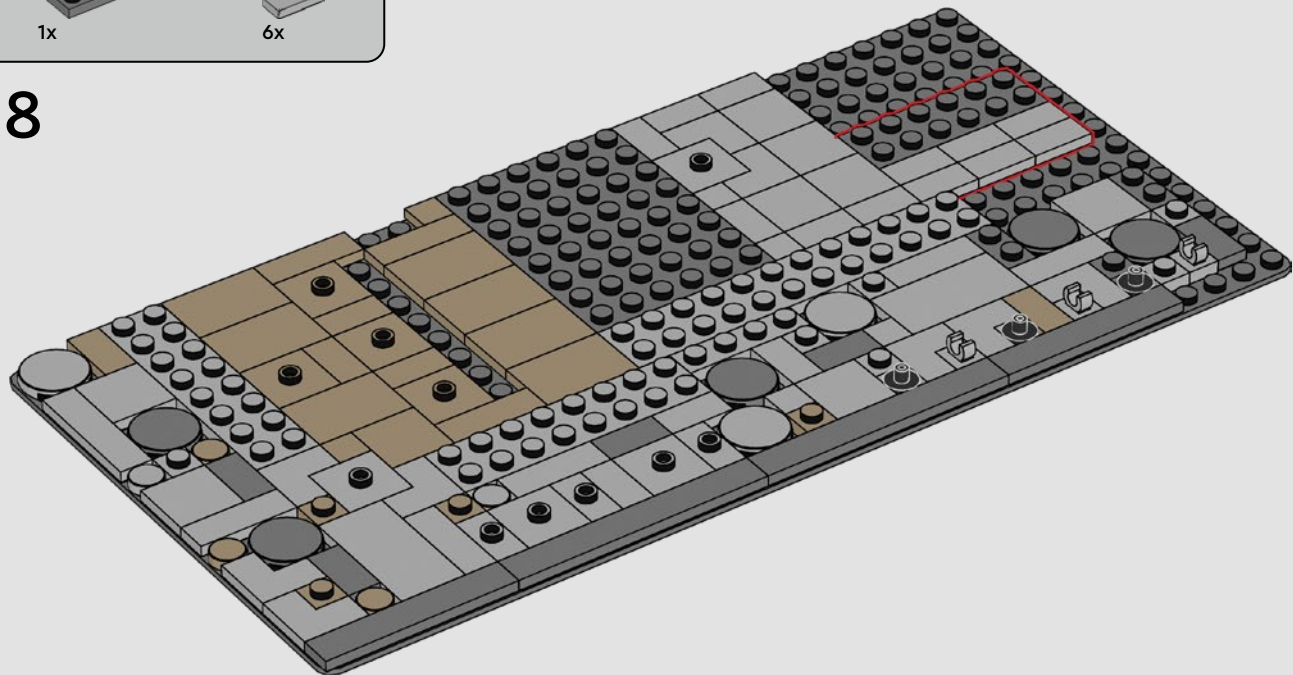



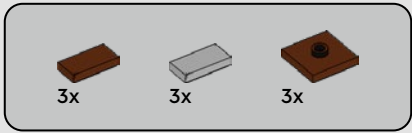

19

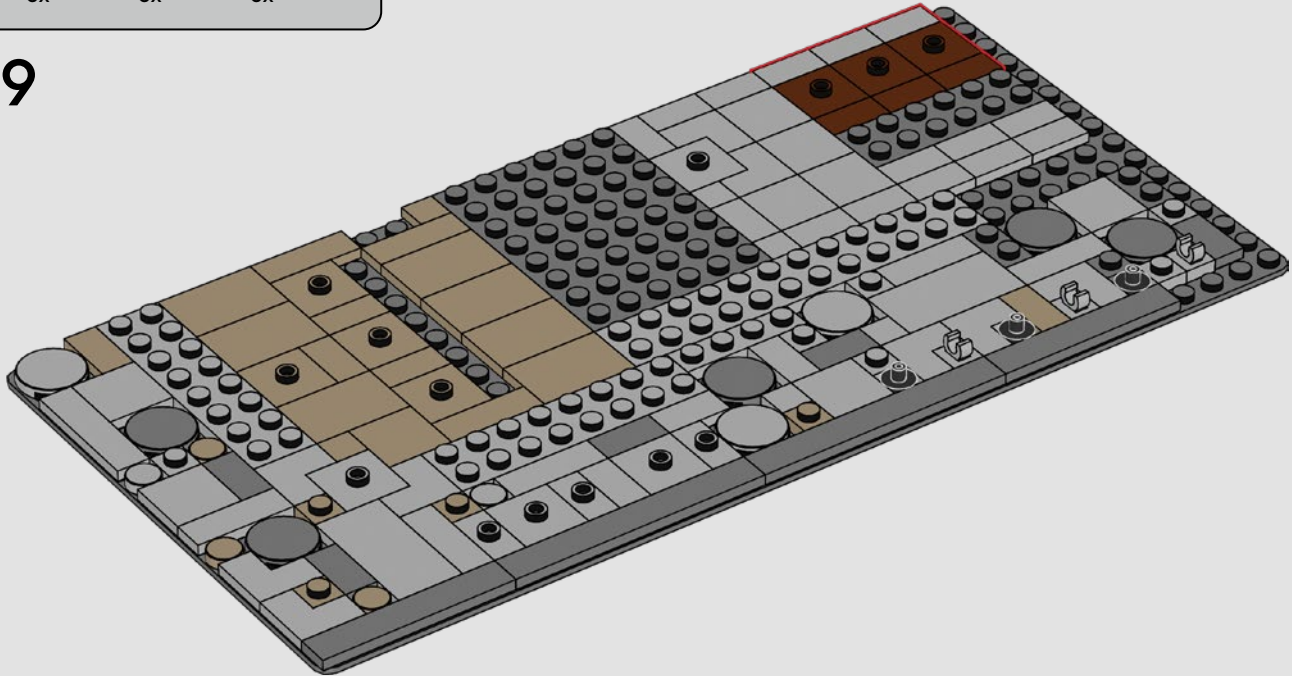

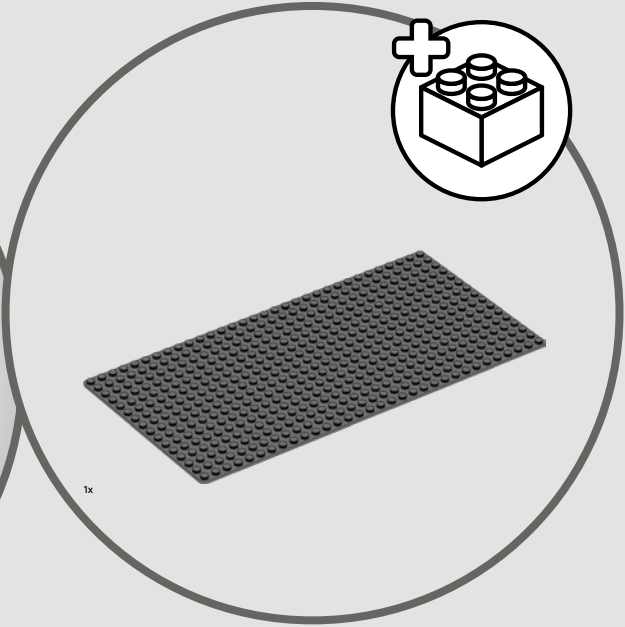

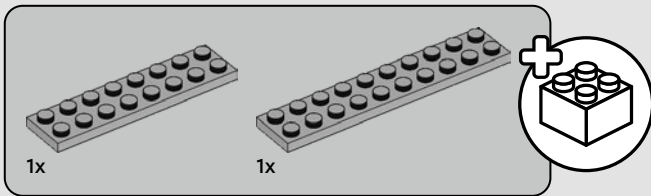

20

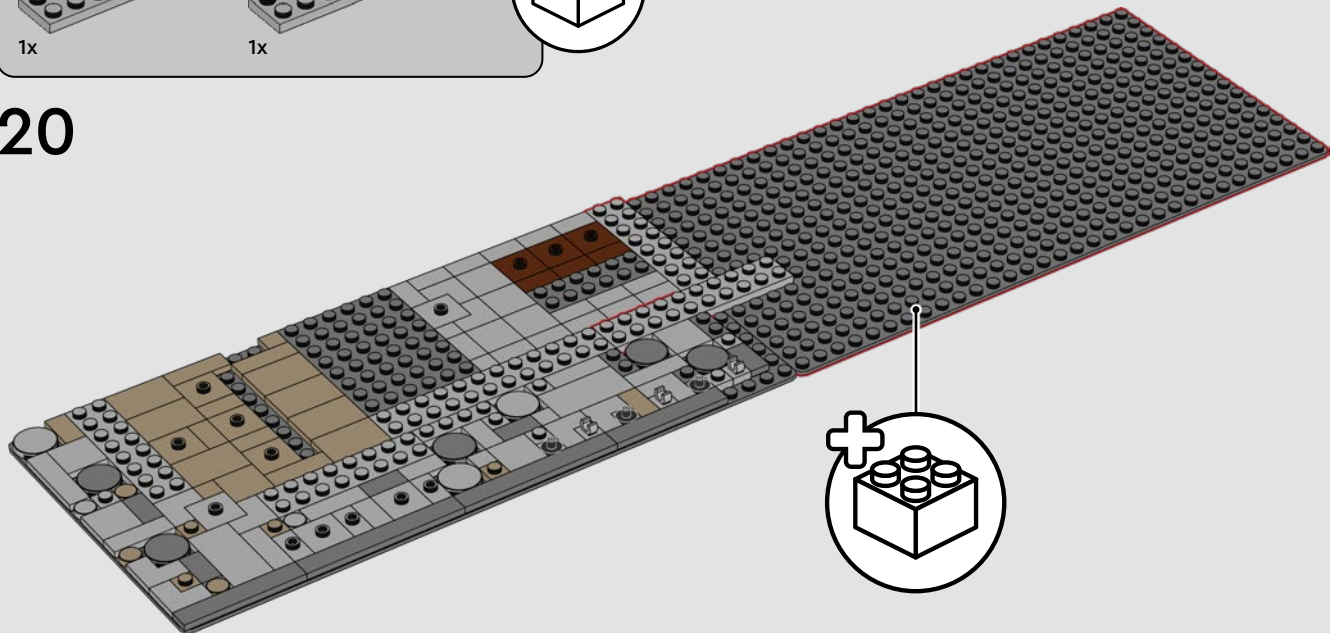

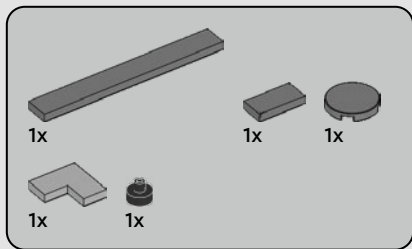

21

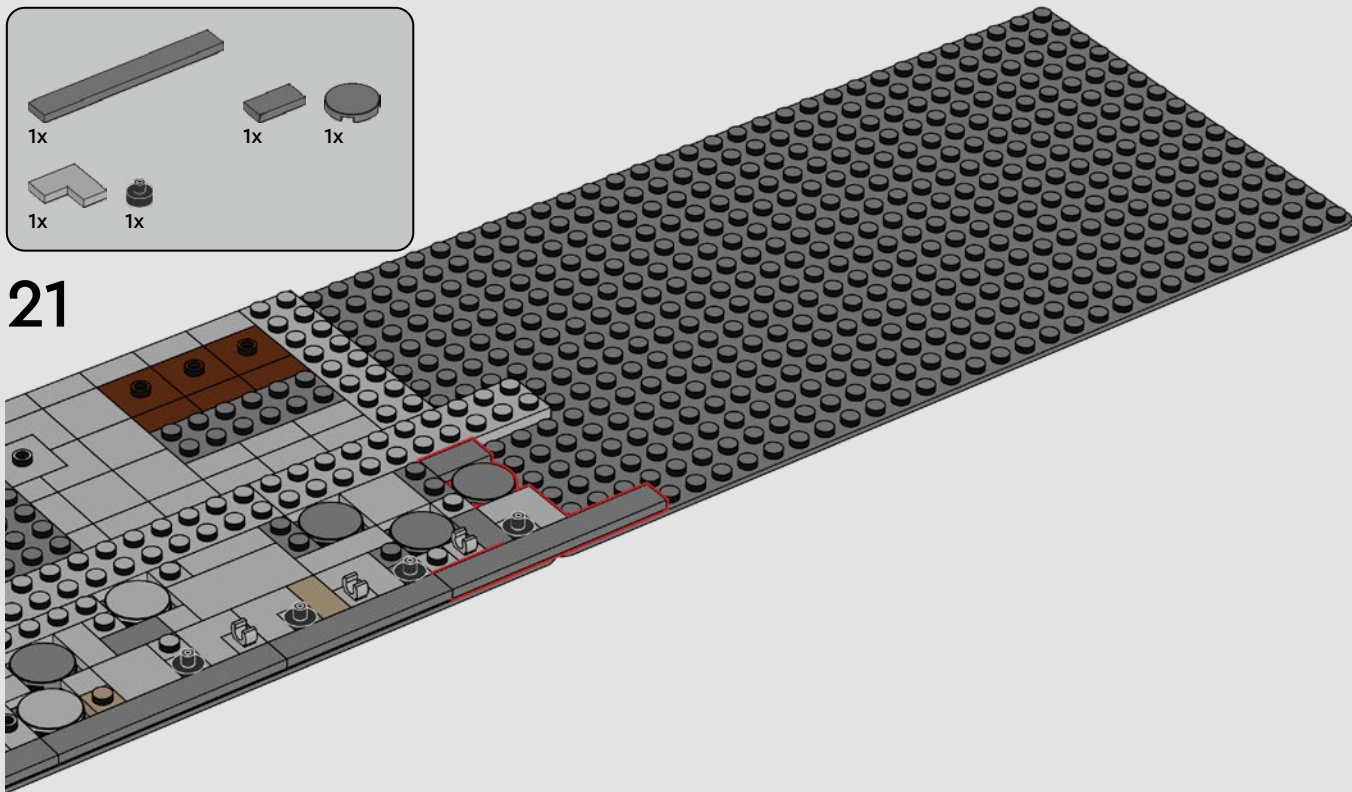

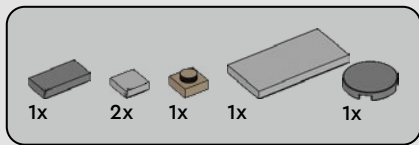

22

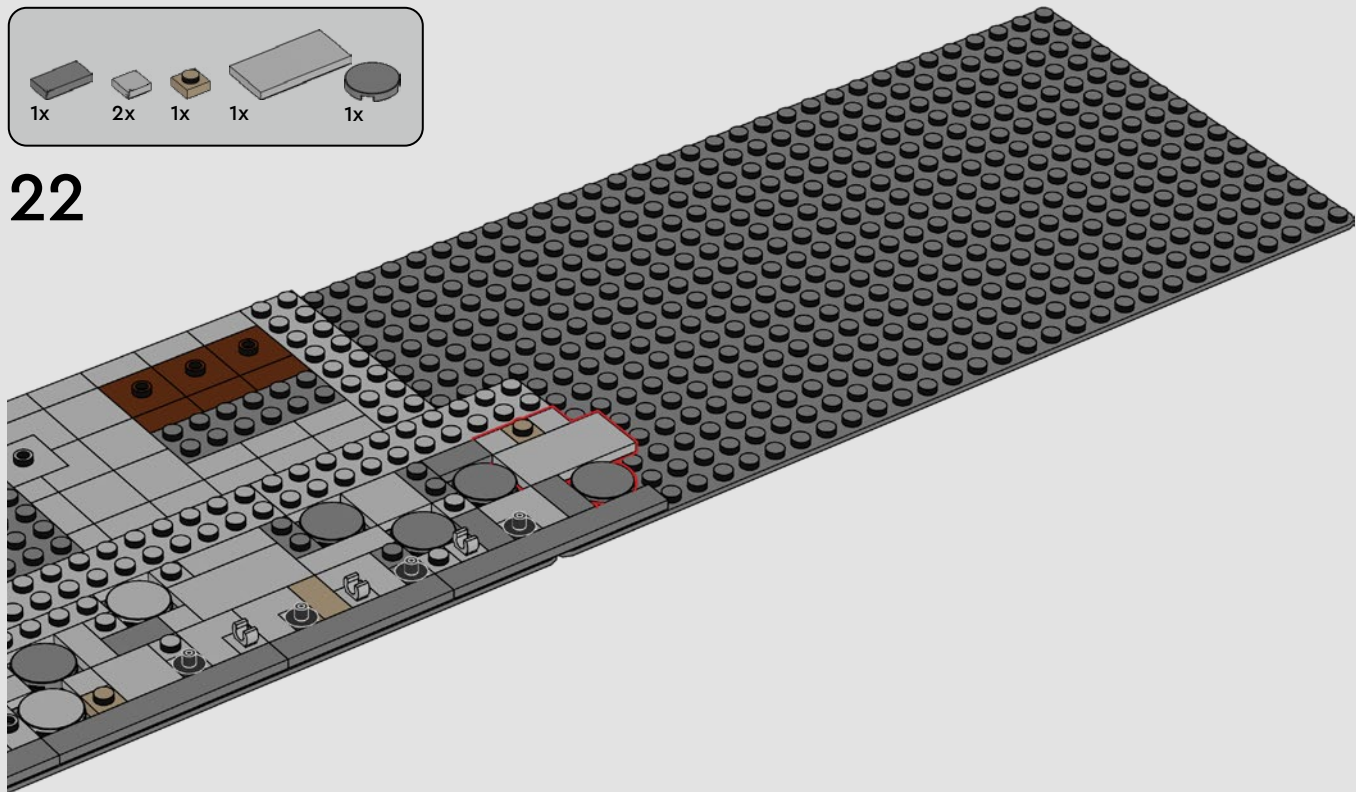

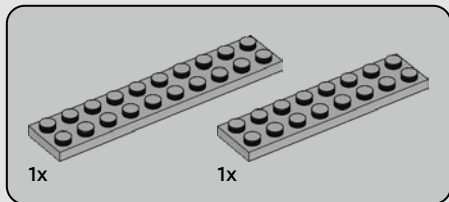

23

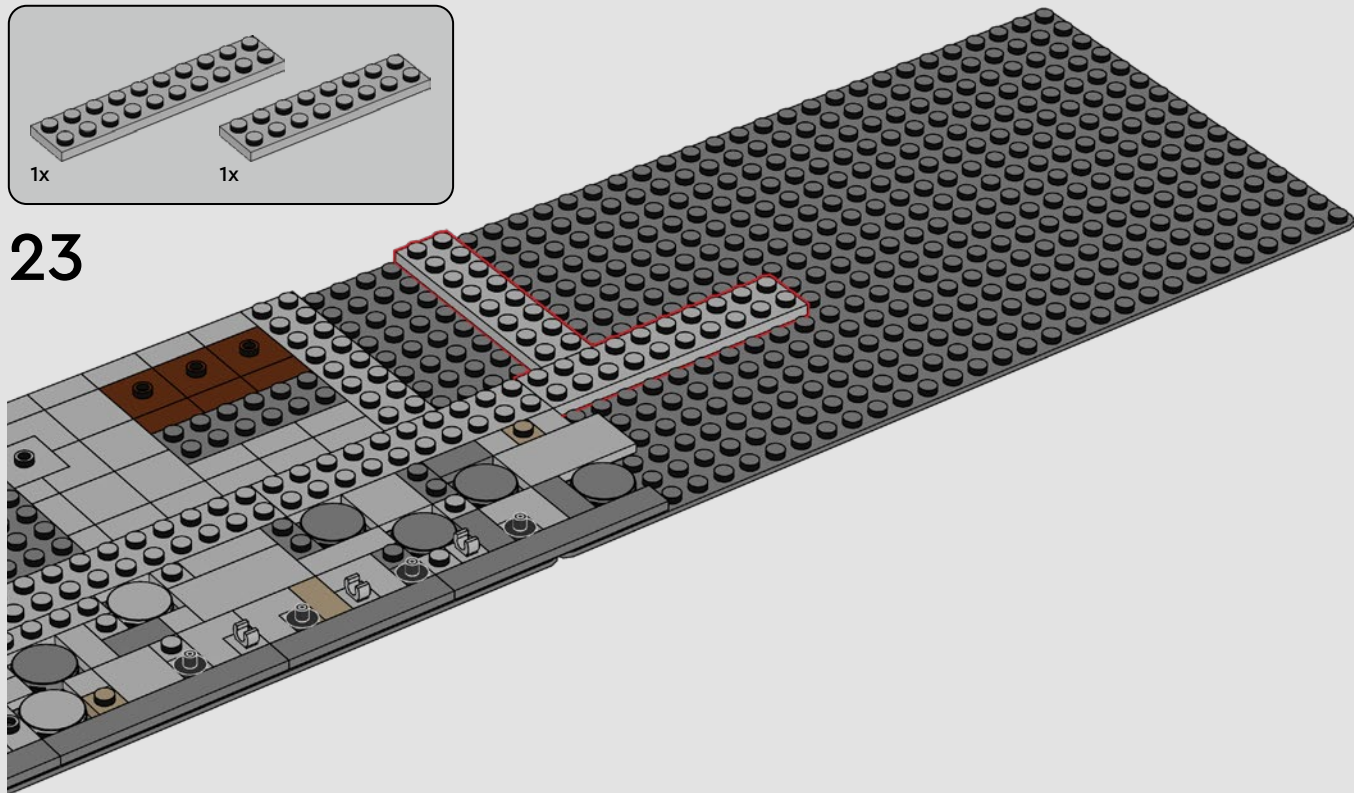





8x

24

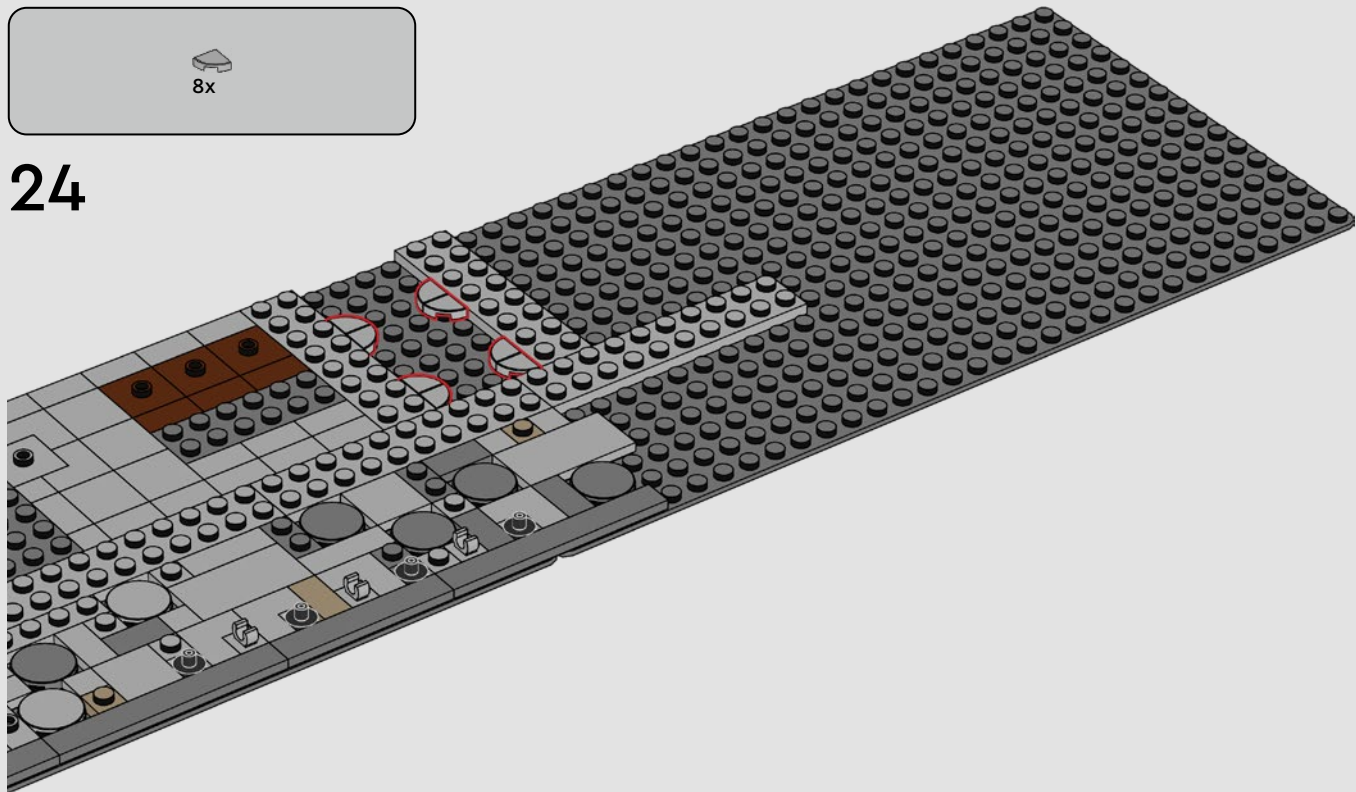



6x

25

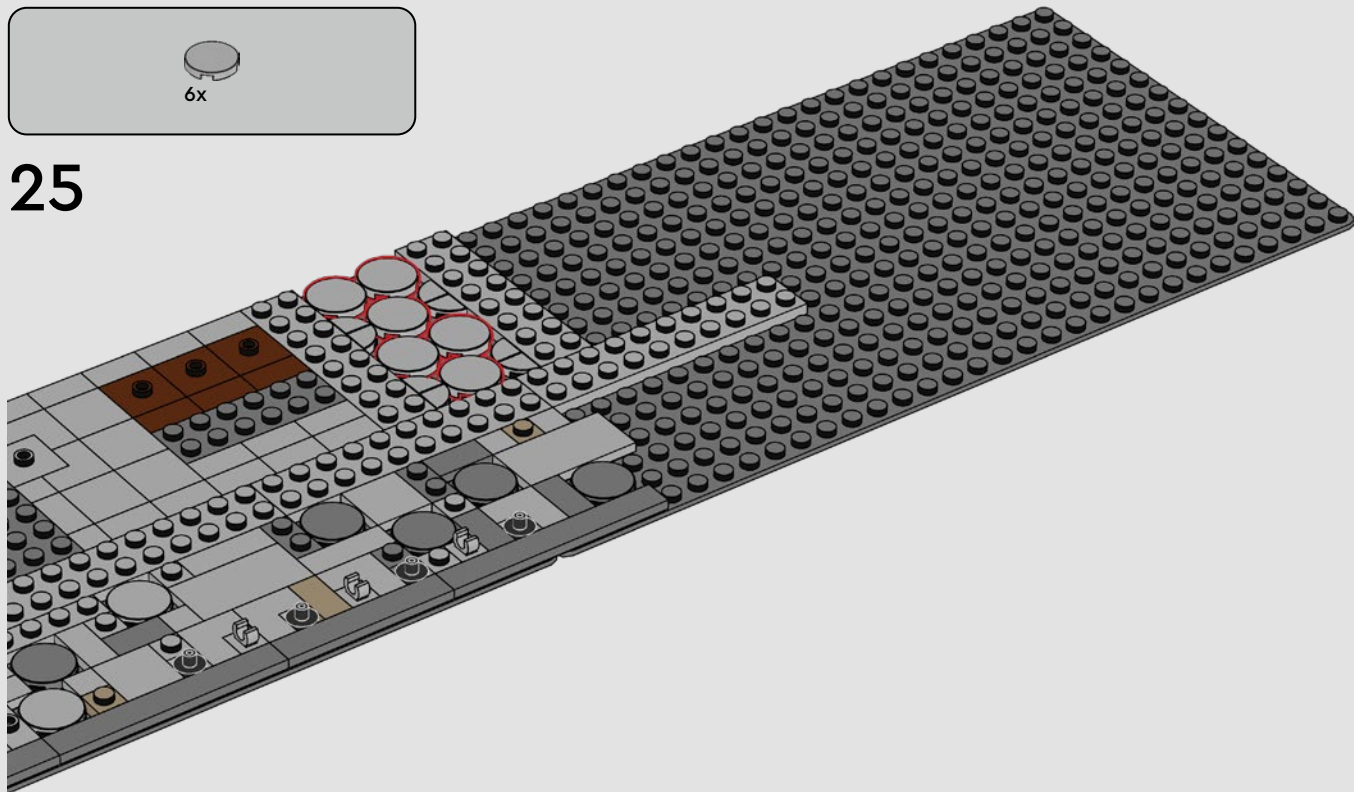

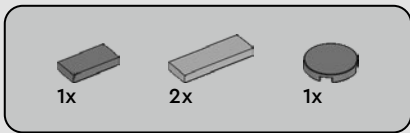

26

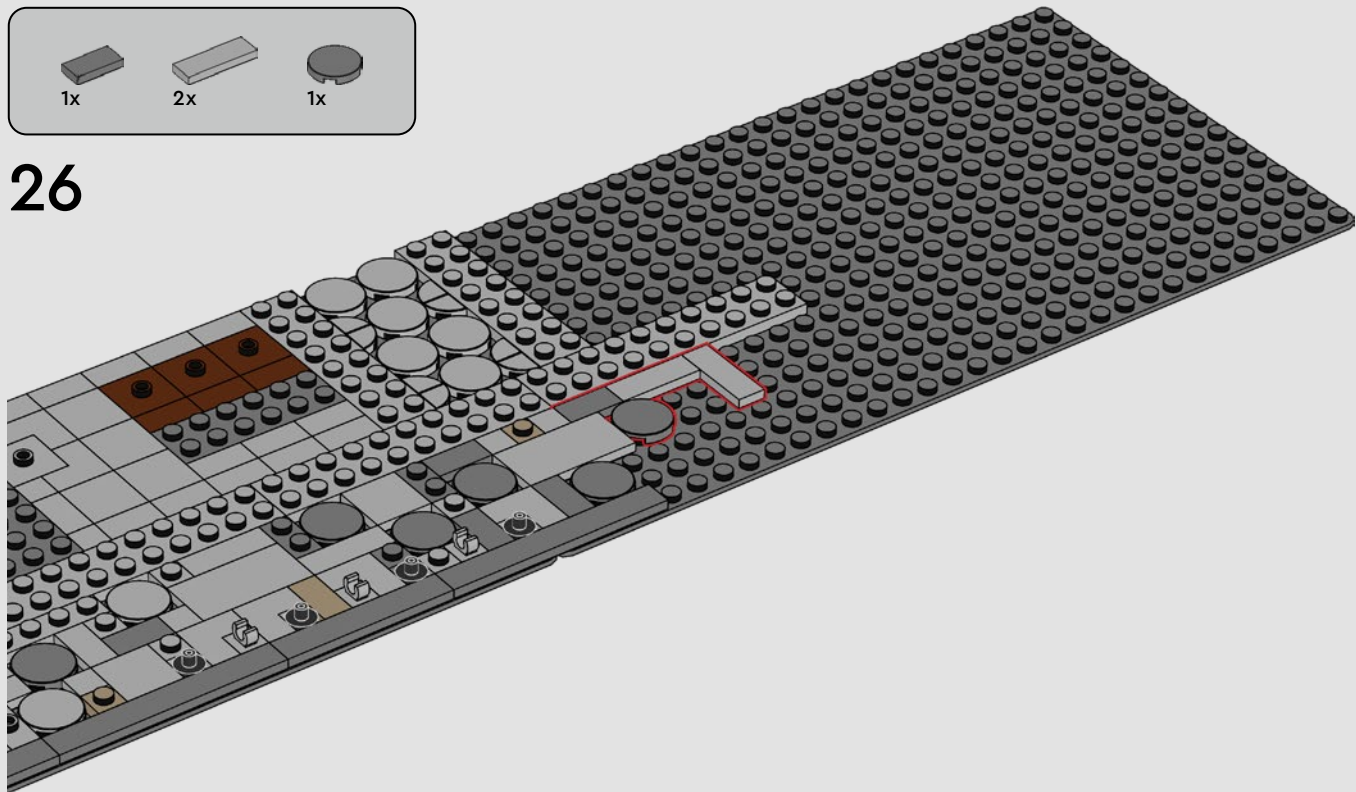

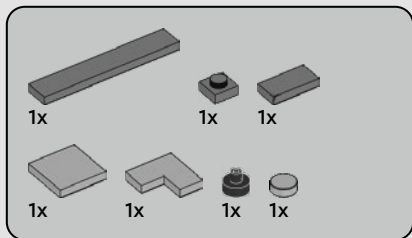

27

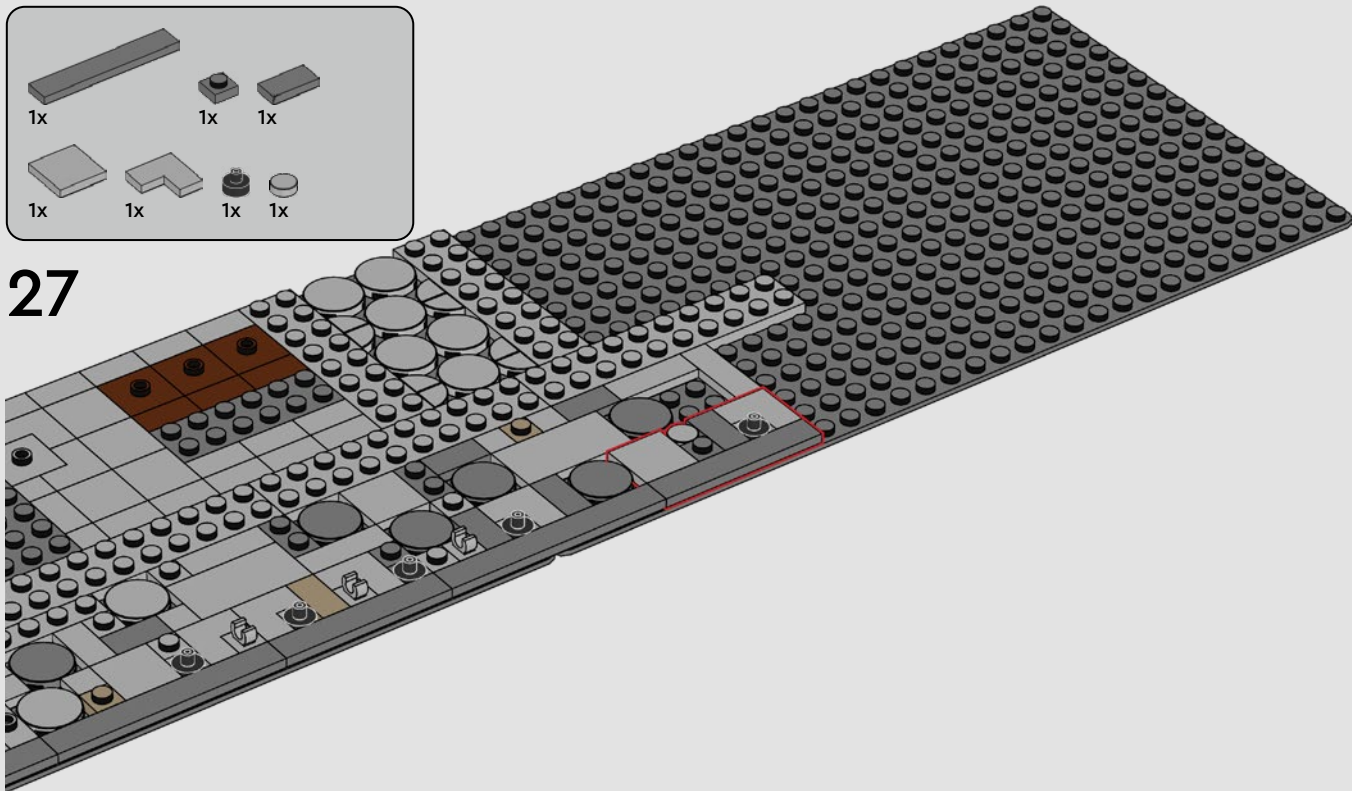

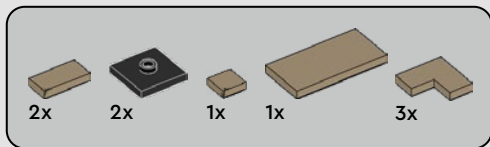

28

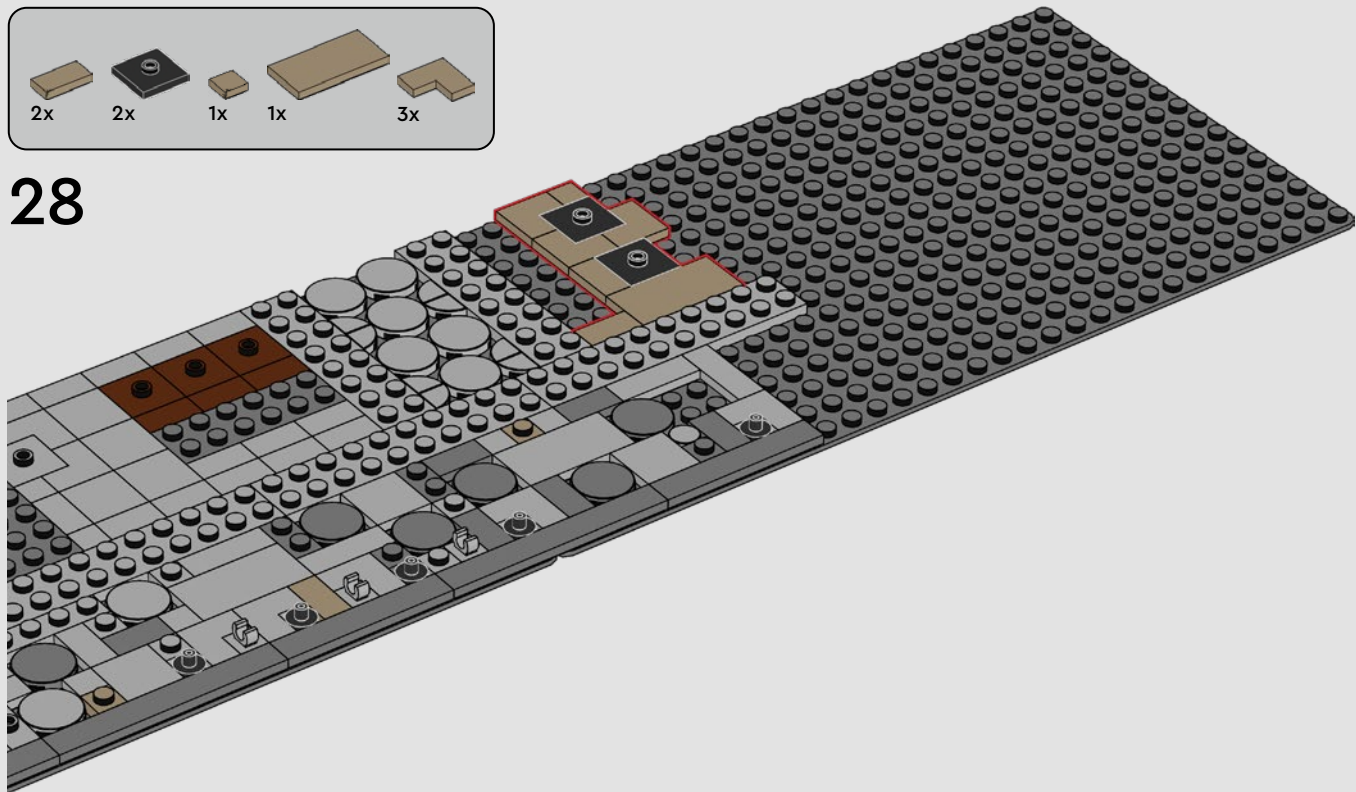



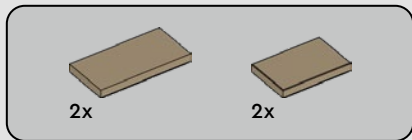

29

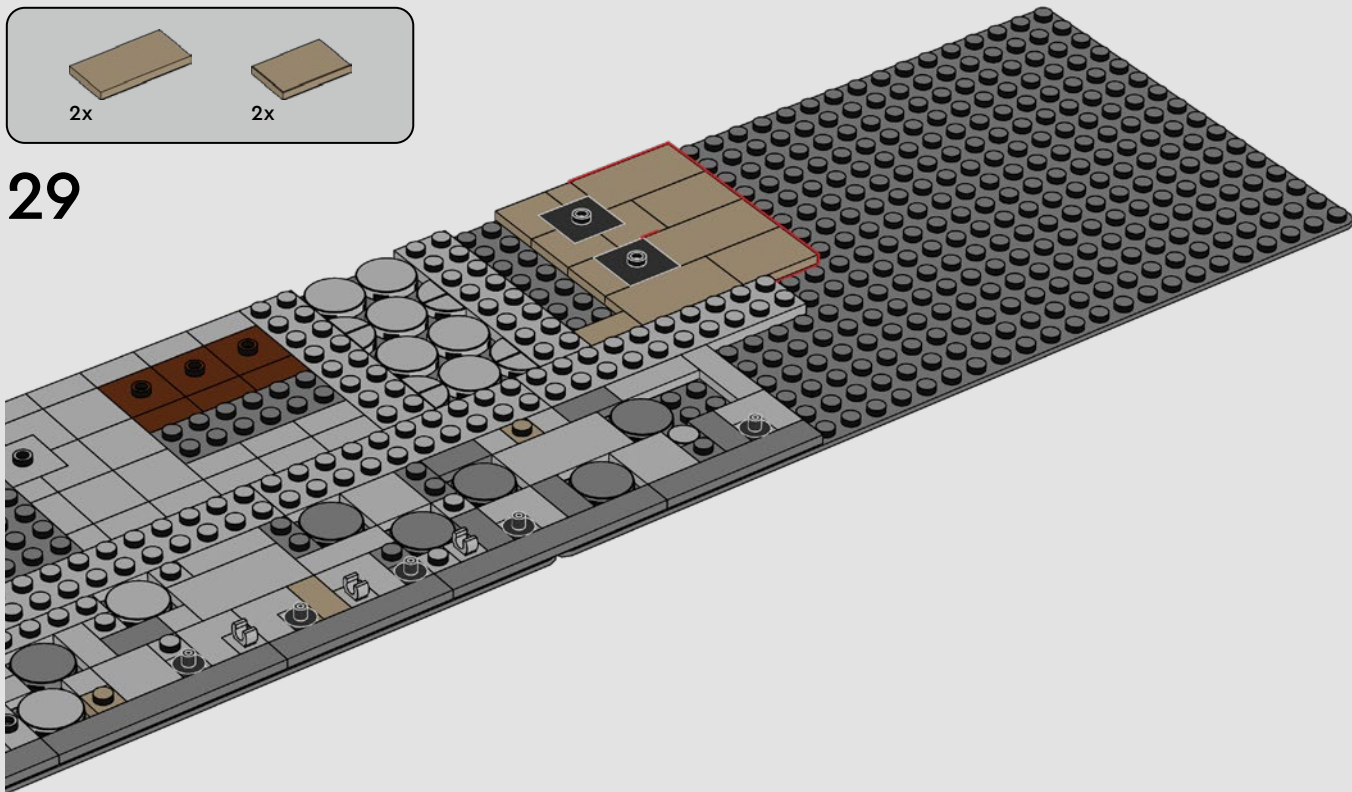



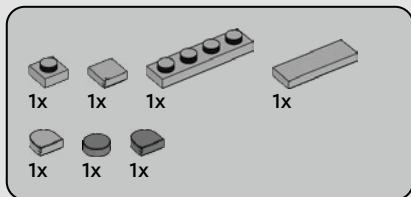

30

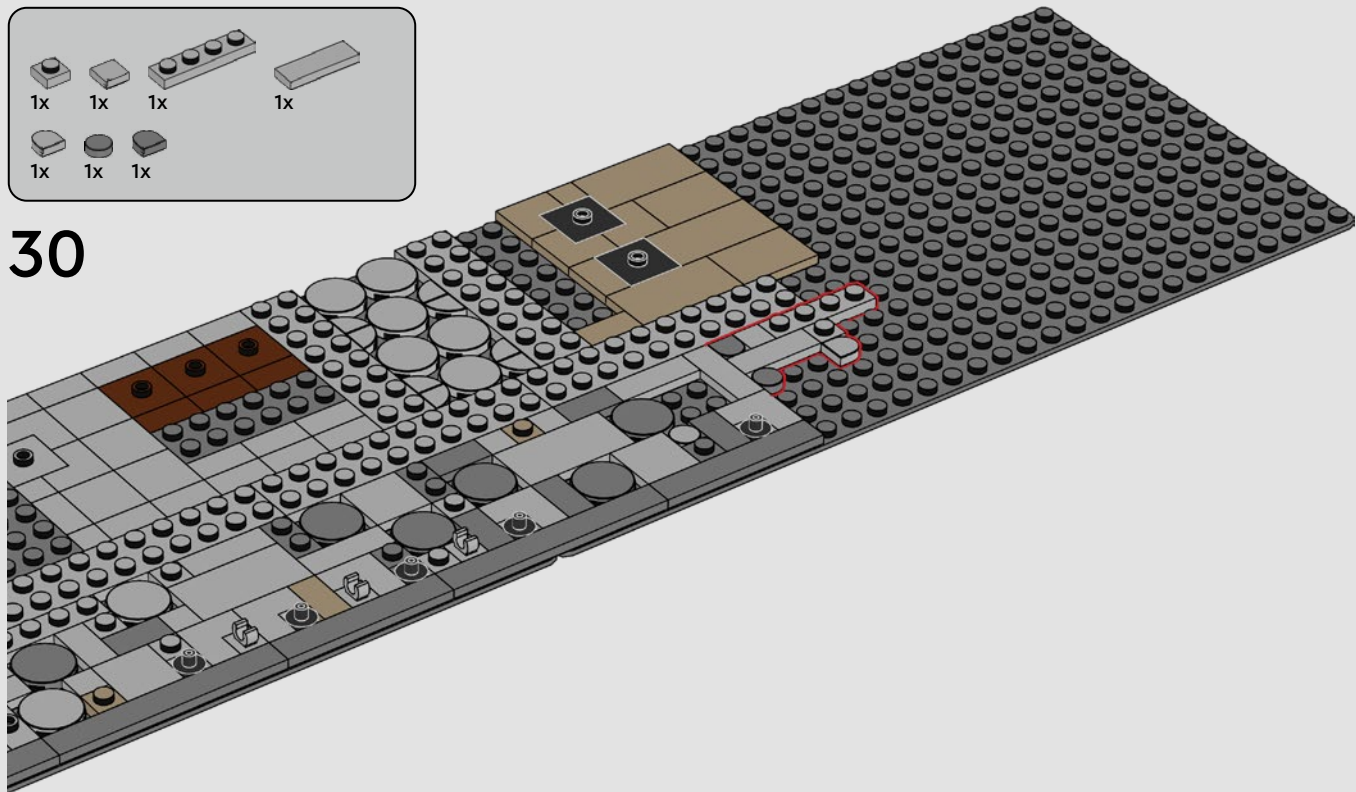

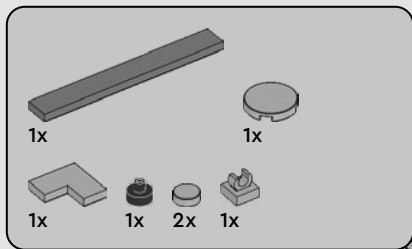

31

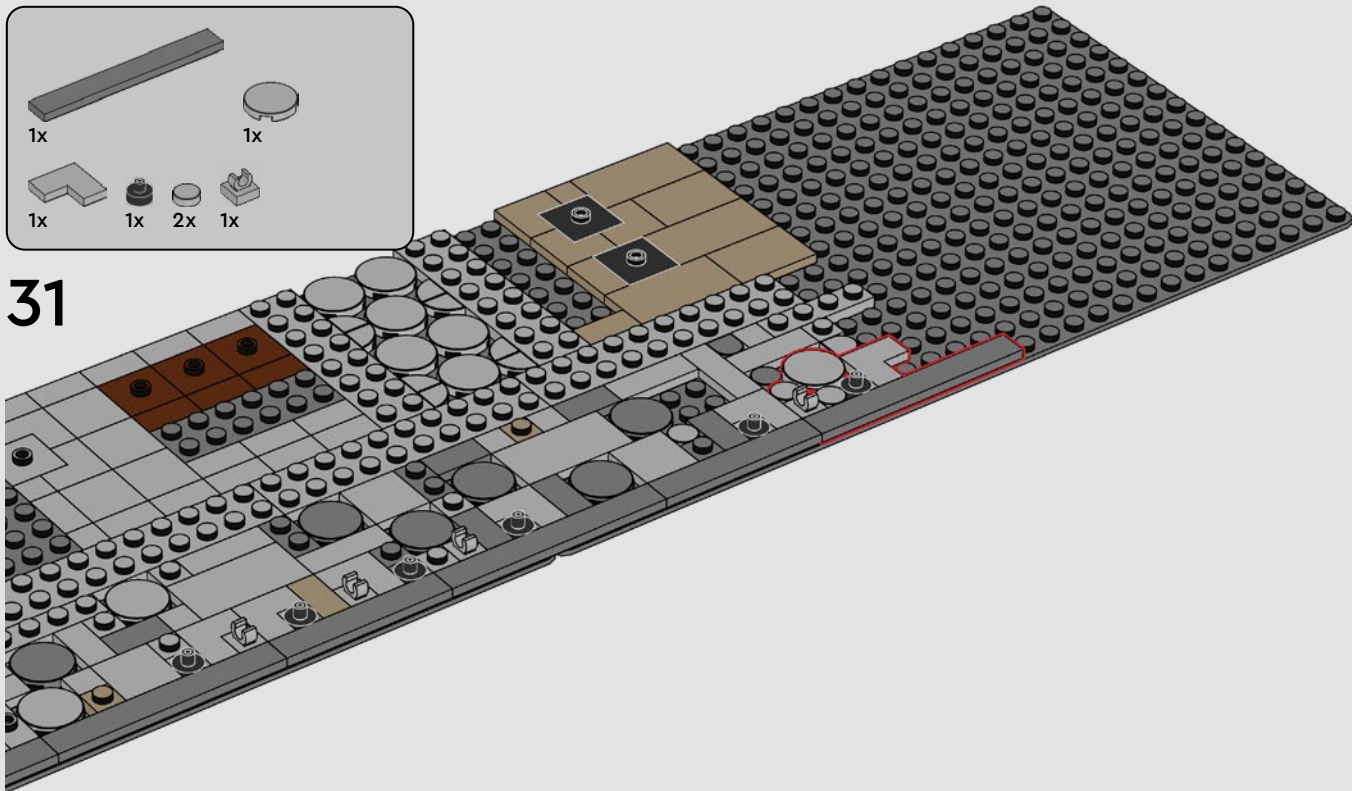

38

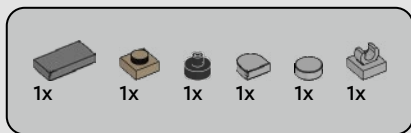

32

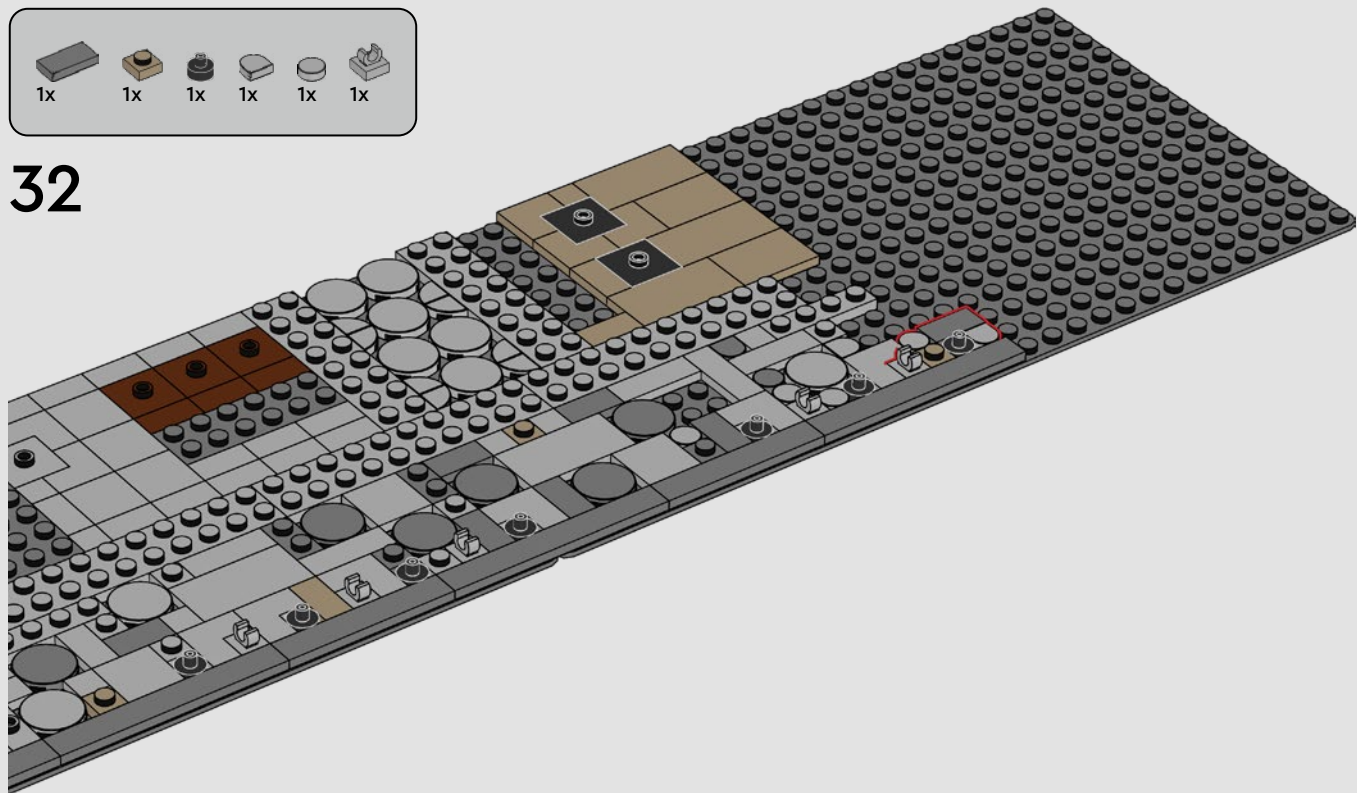

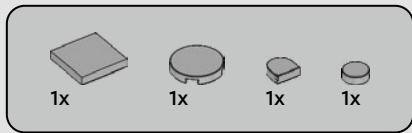

33

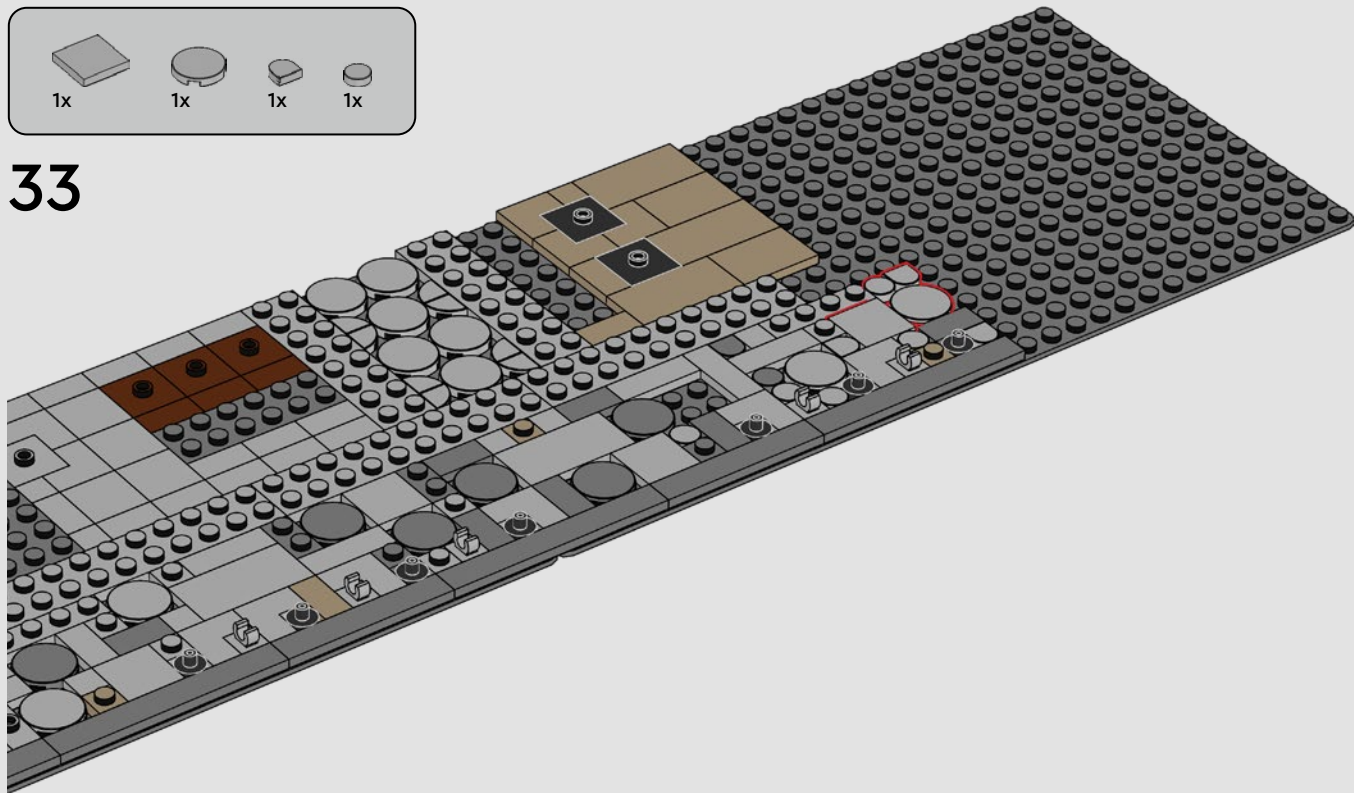

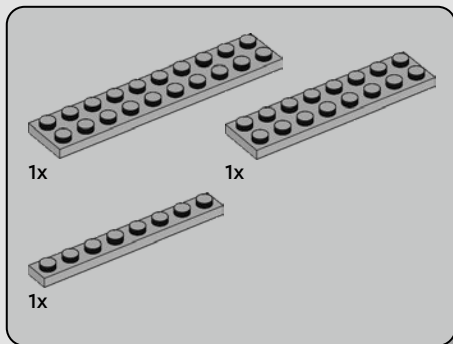

34

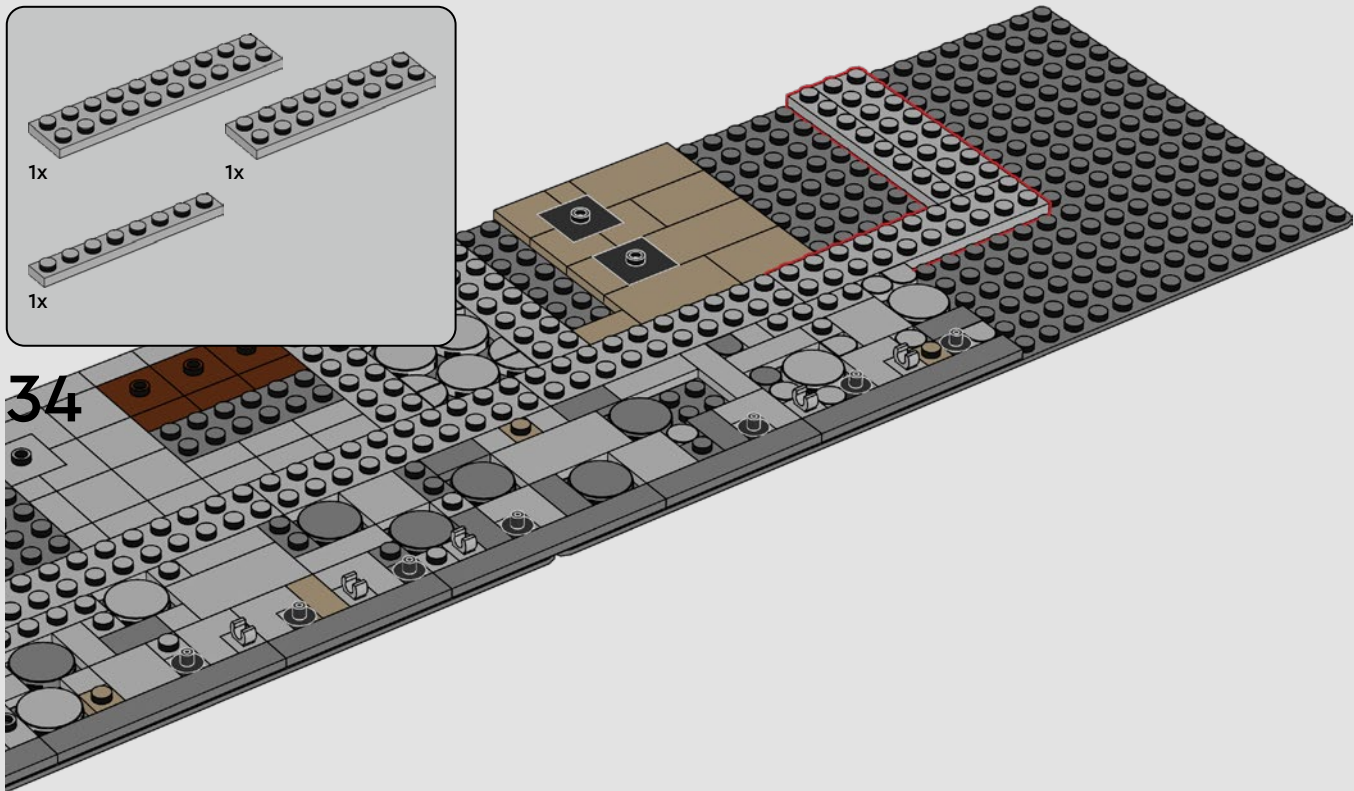



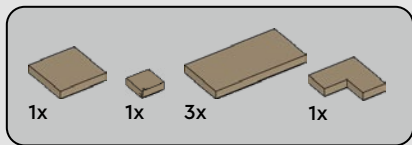

35

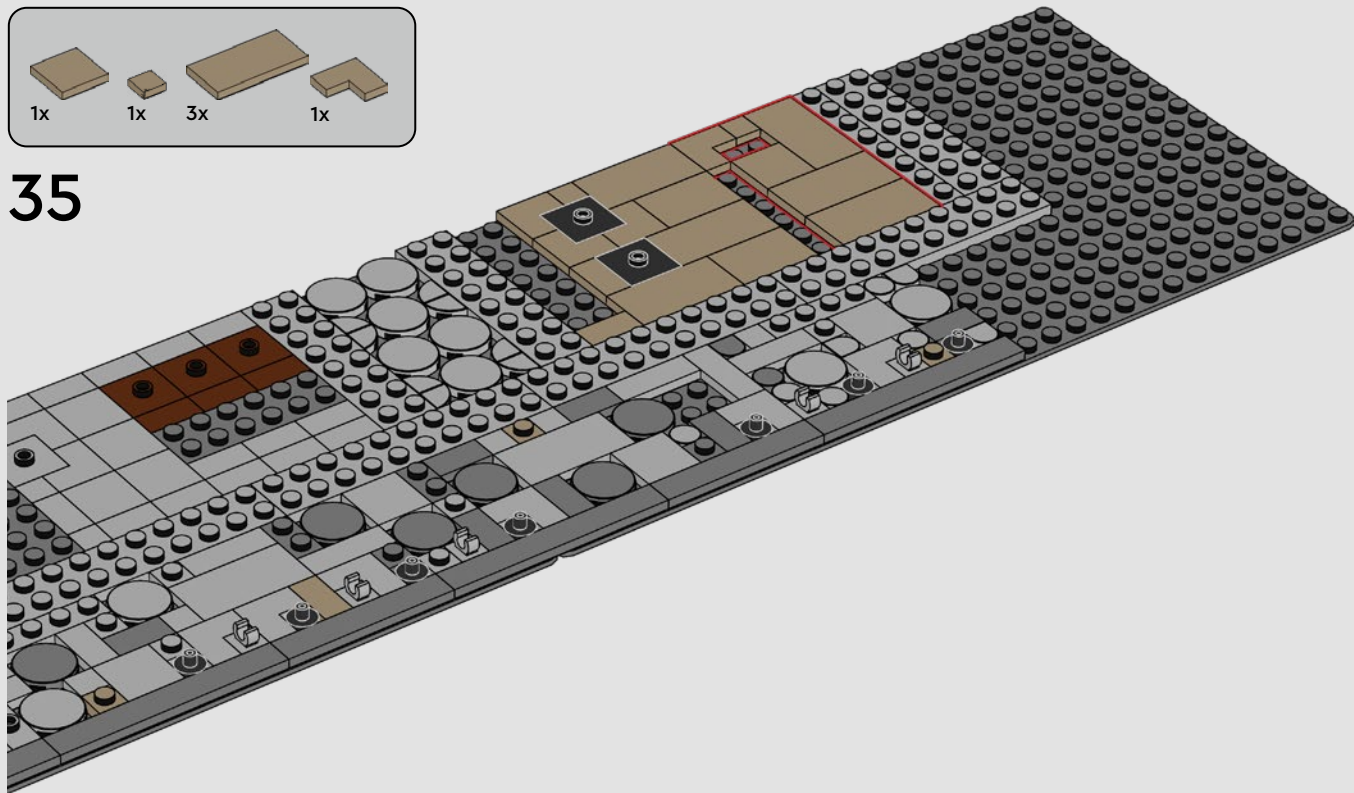



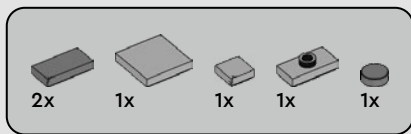

36

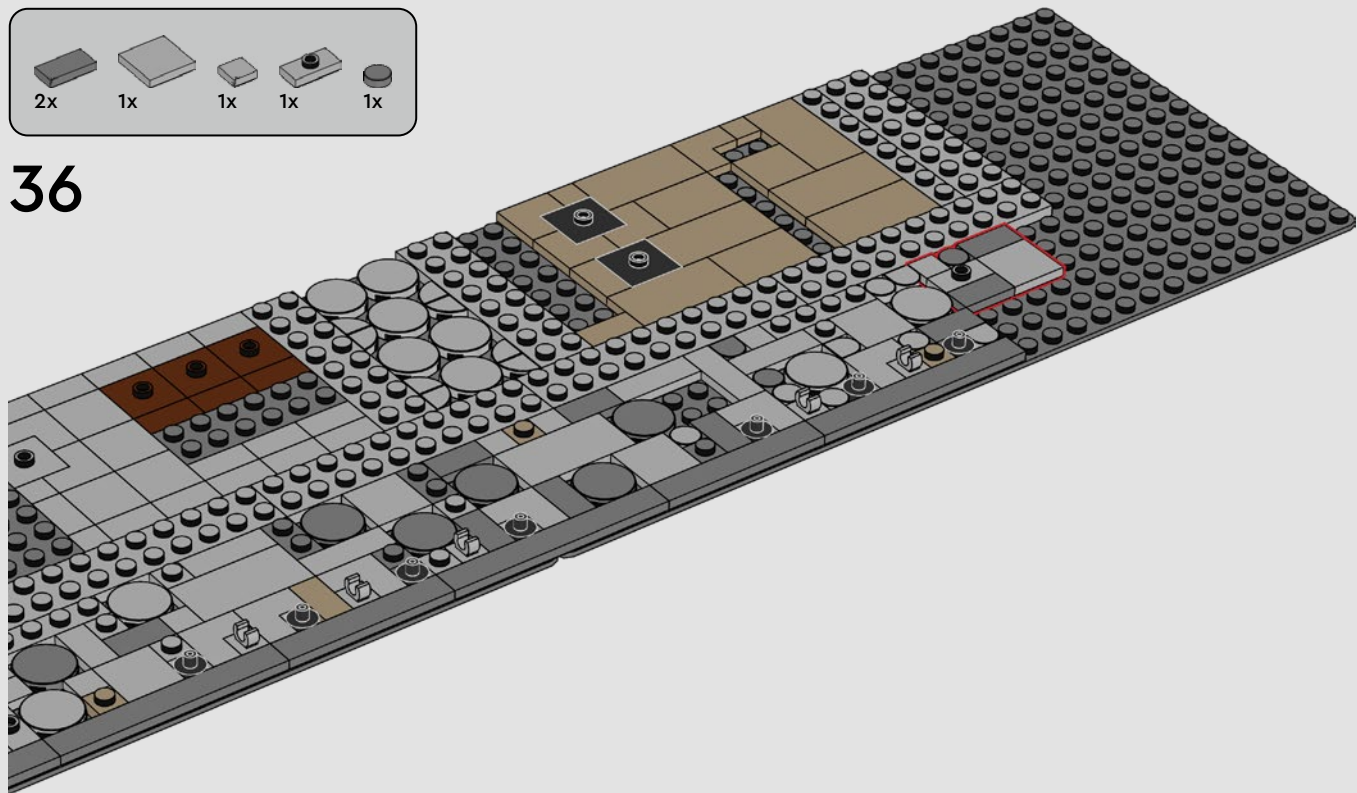

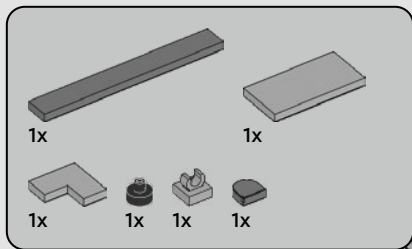

37

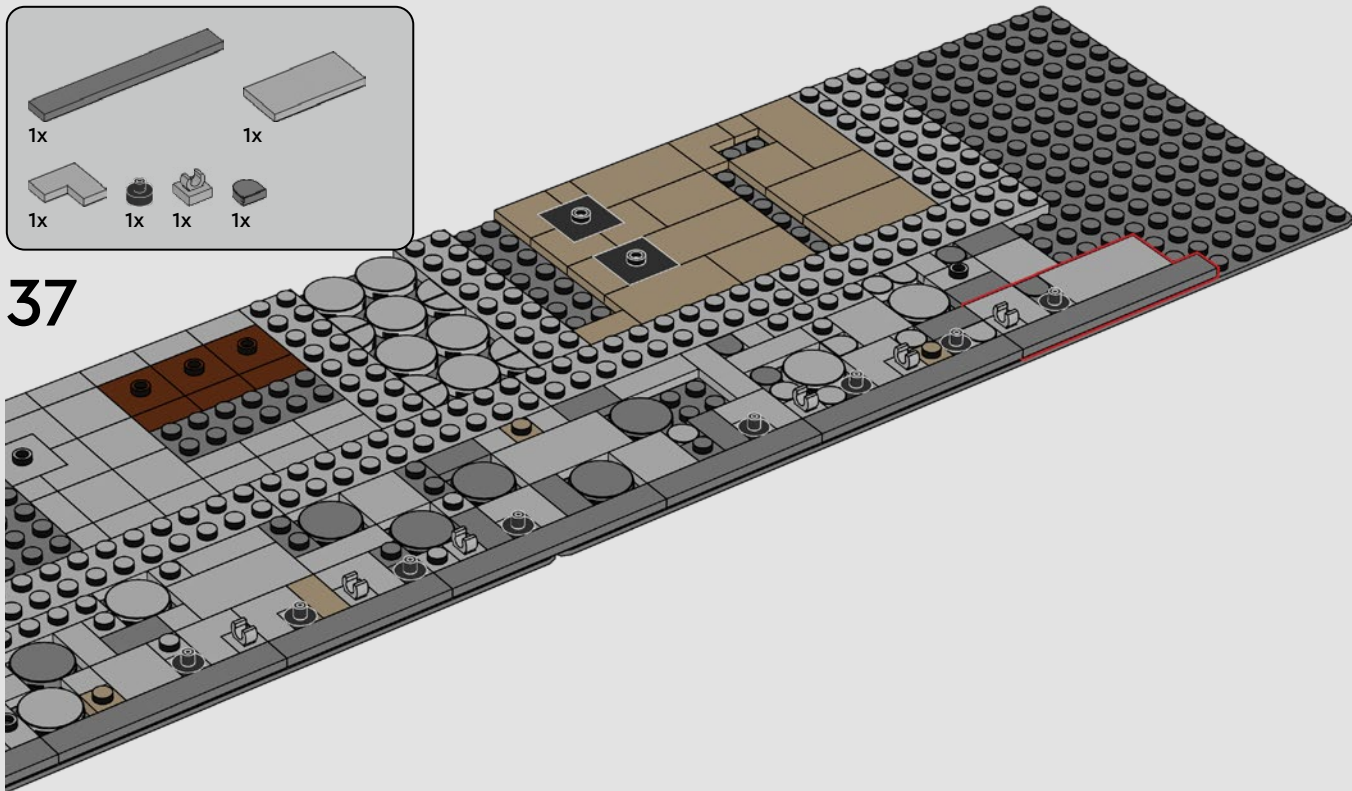

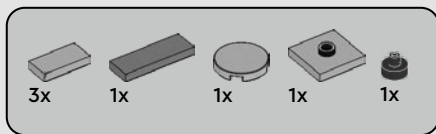

38

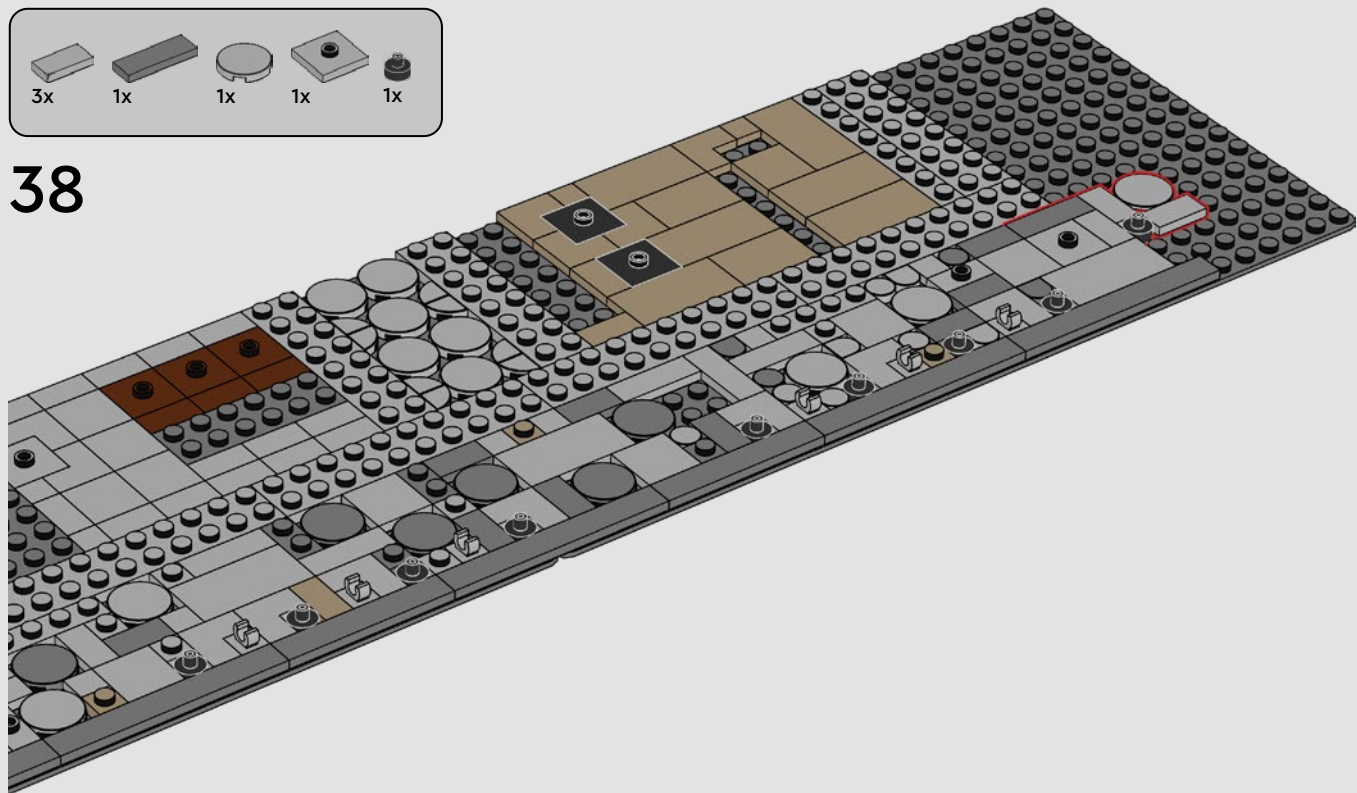

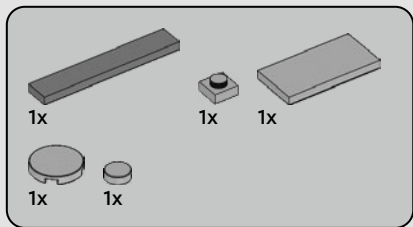

39

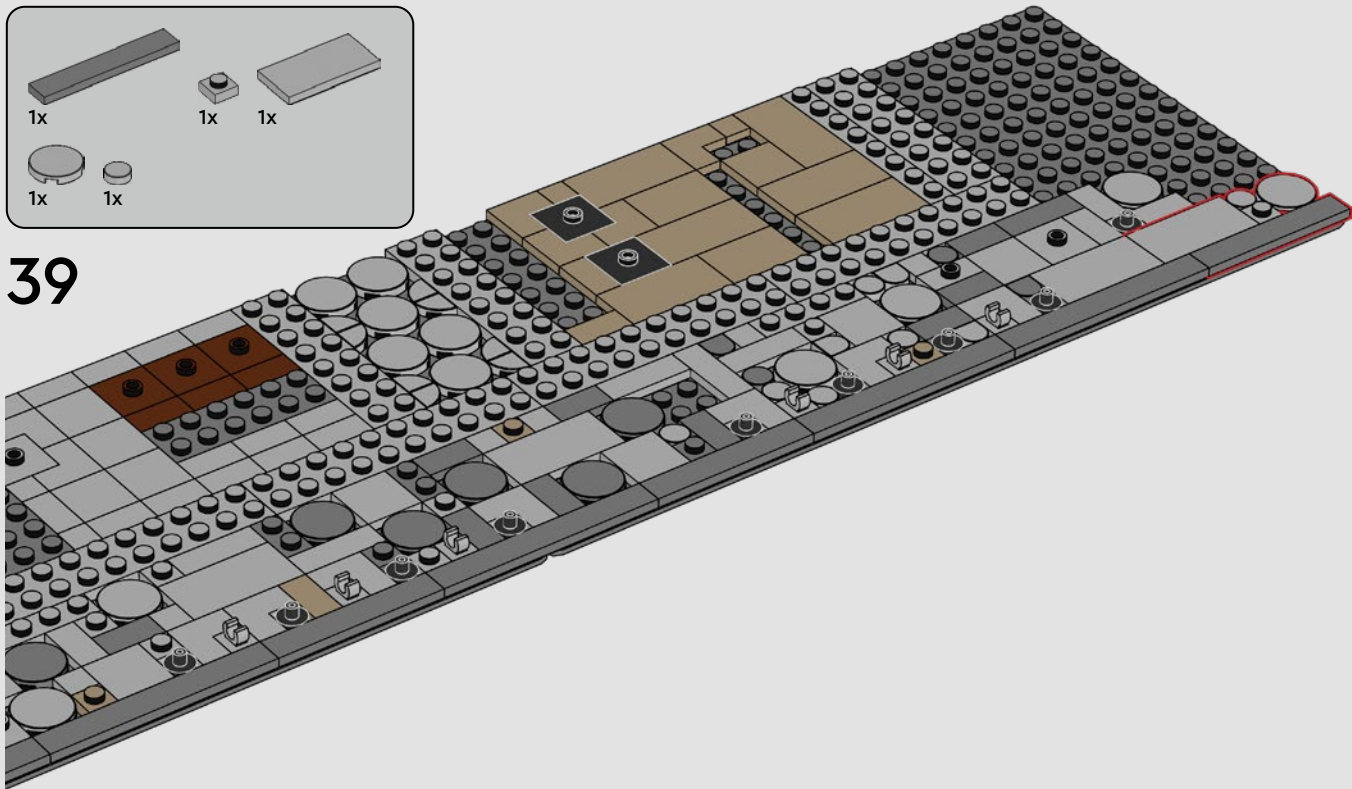

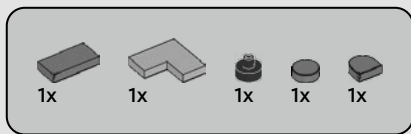

40

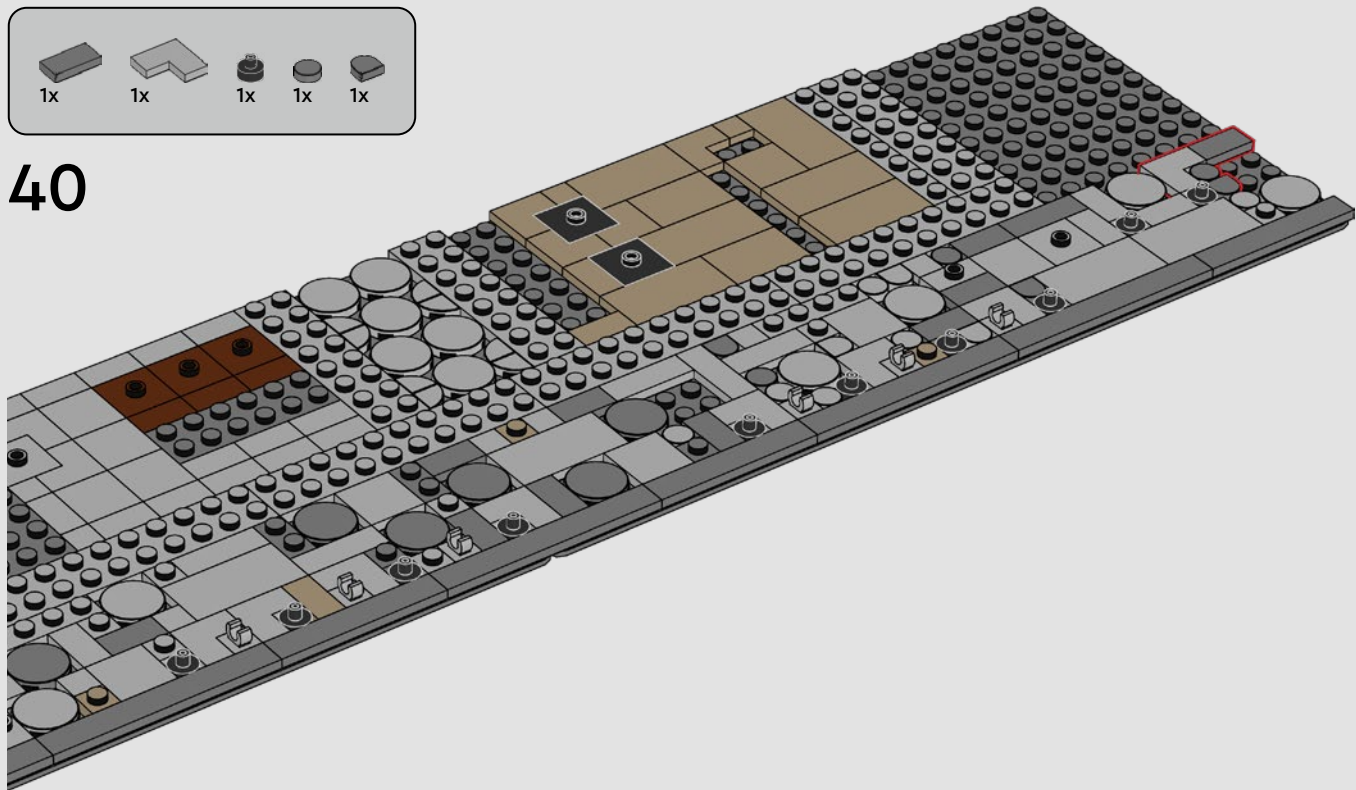



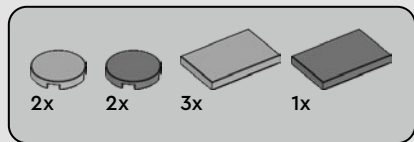

41

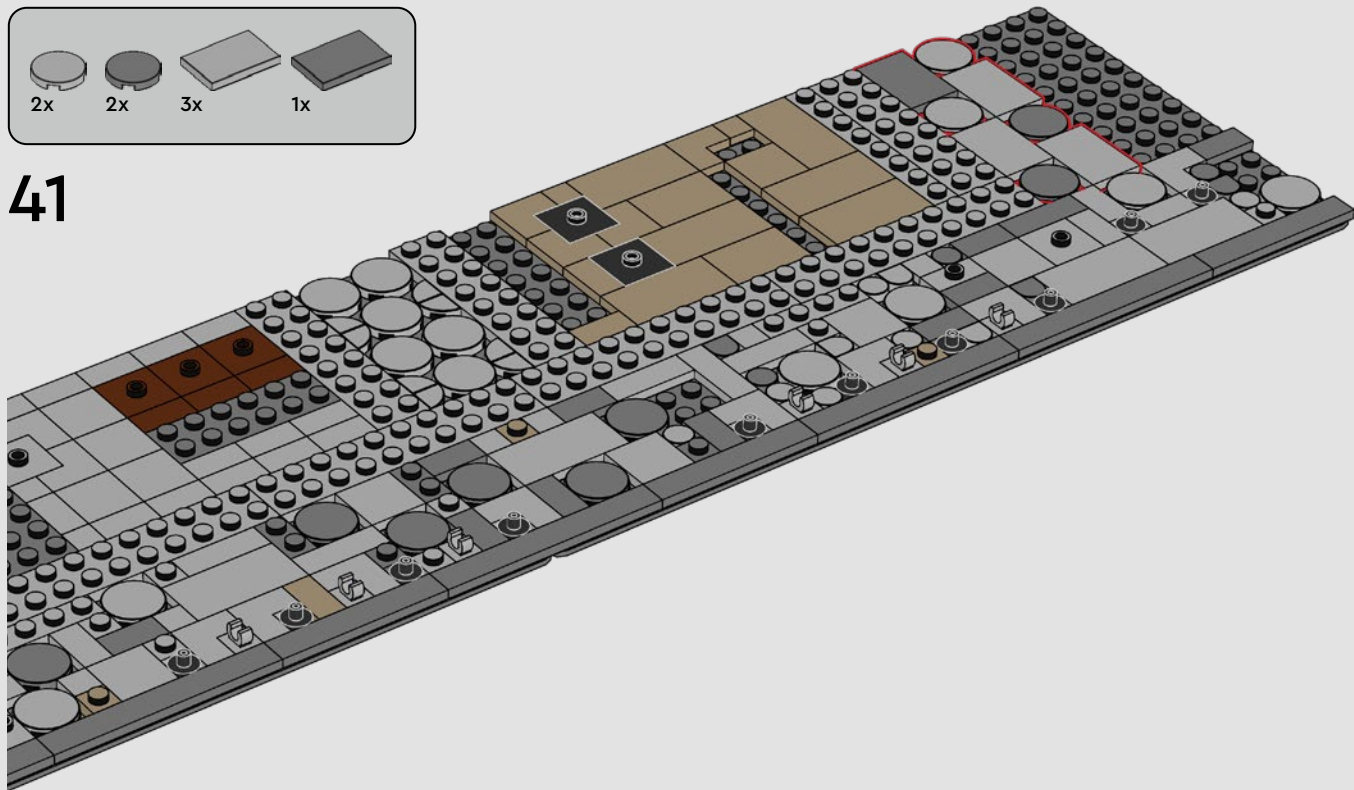

48



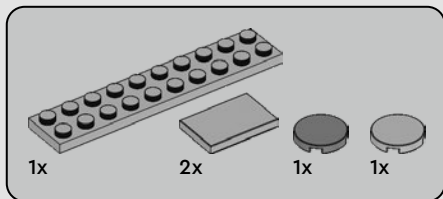

42

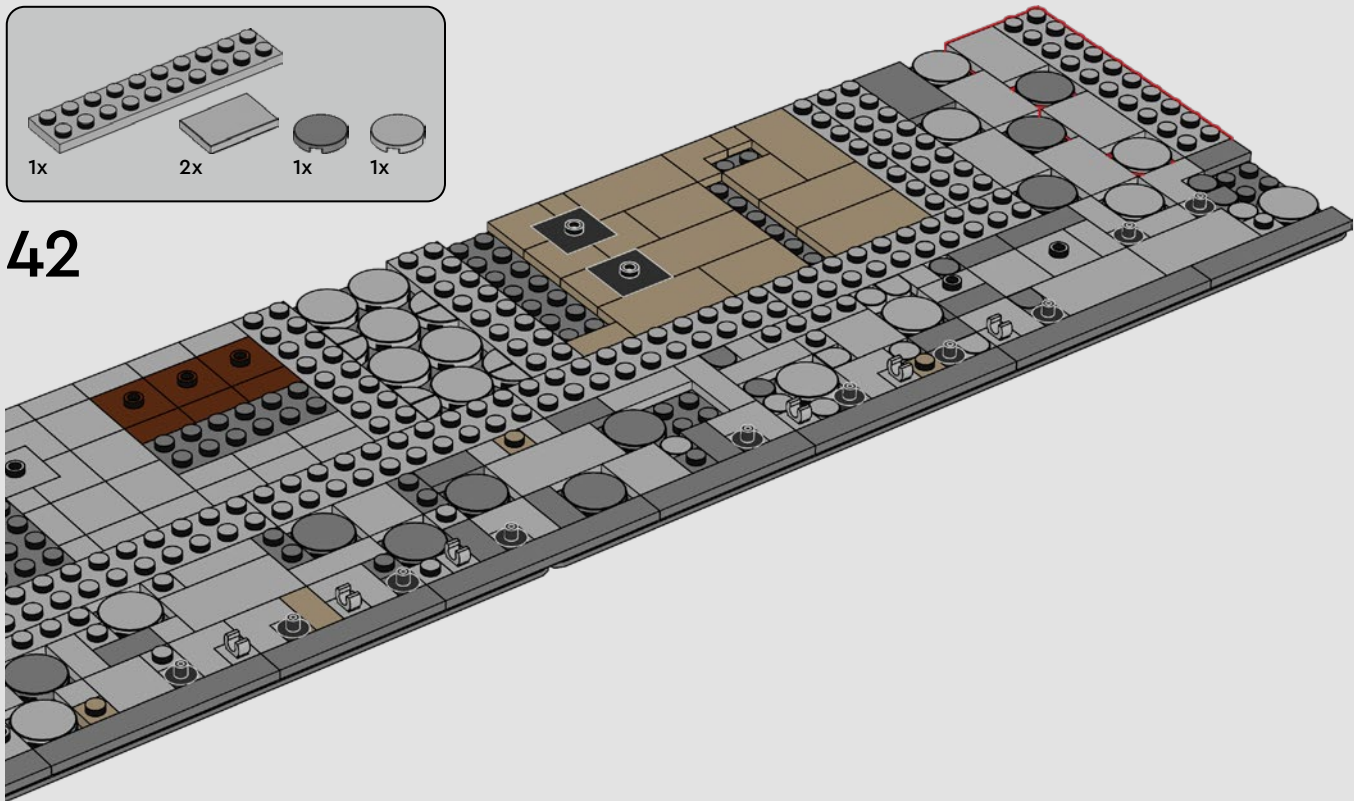

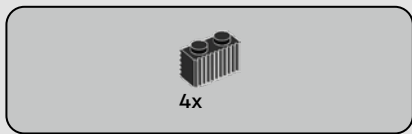

43

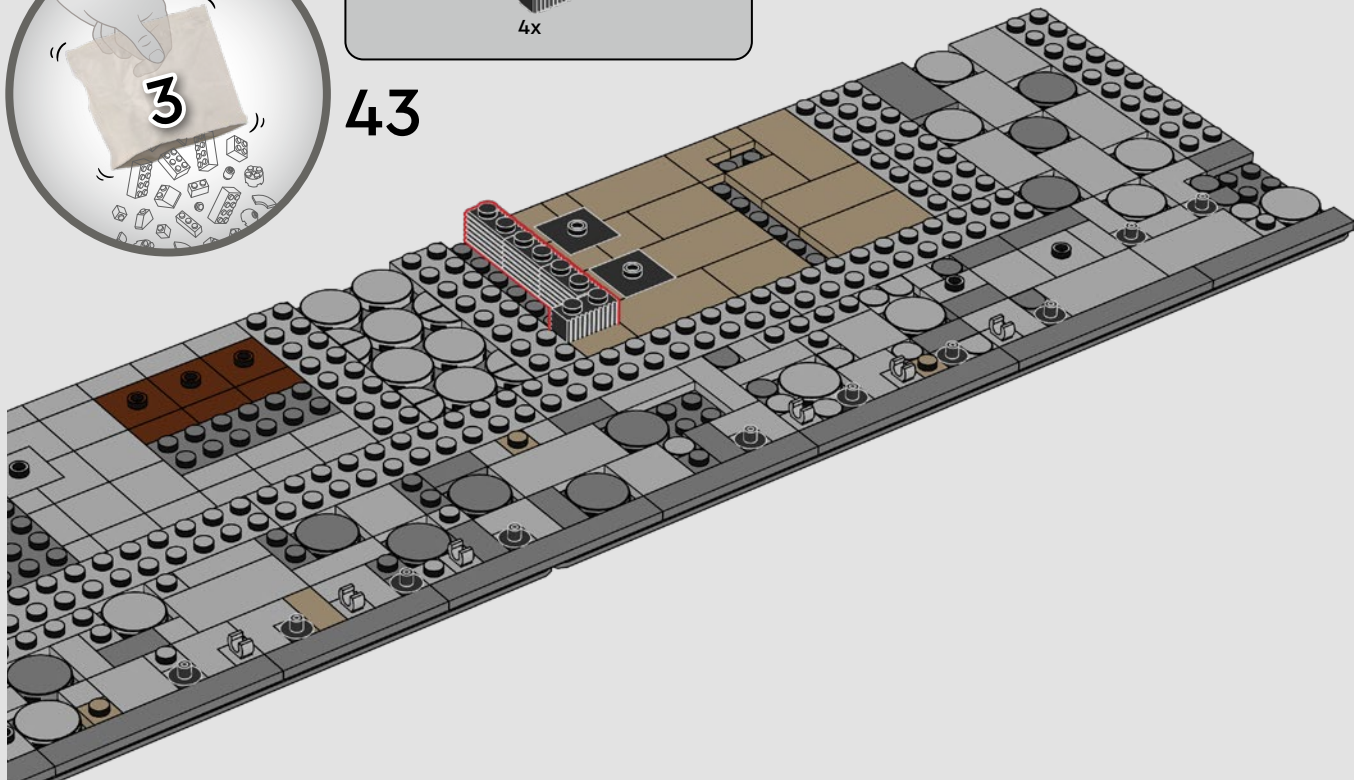

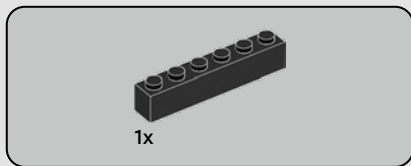

44

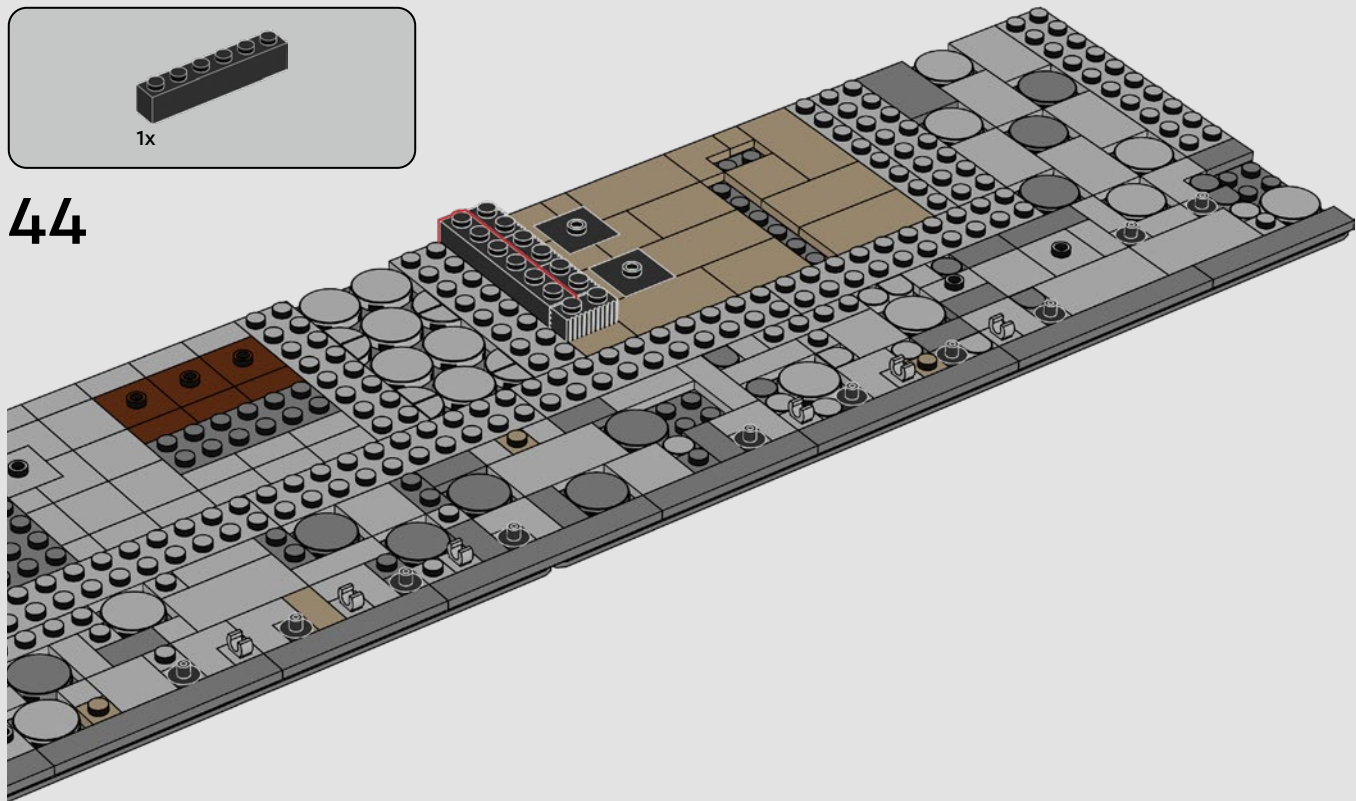

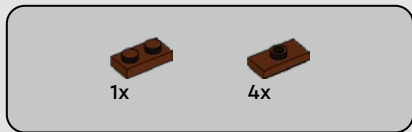

45

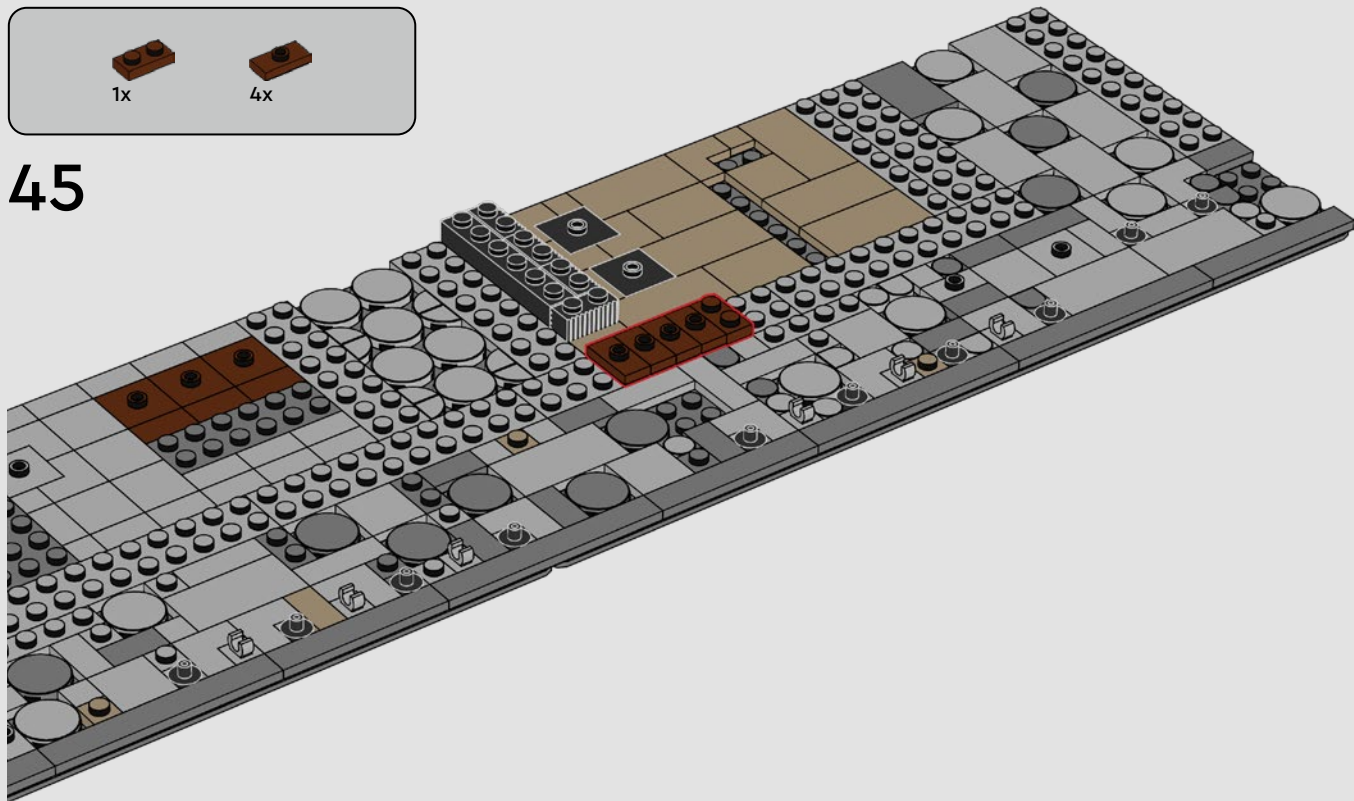

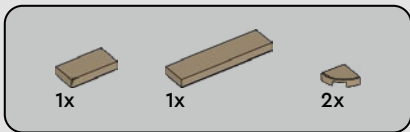

46

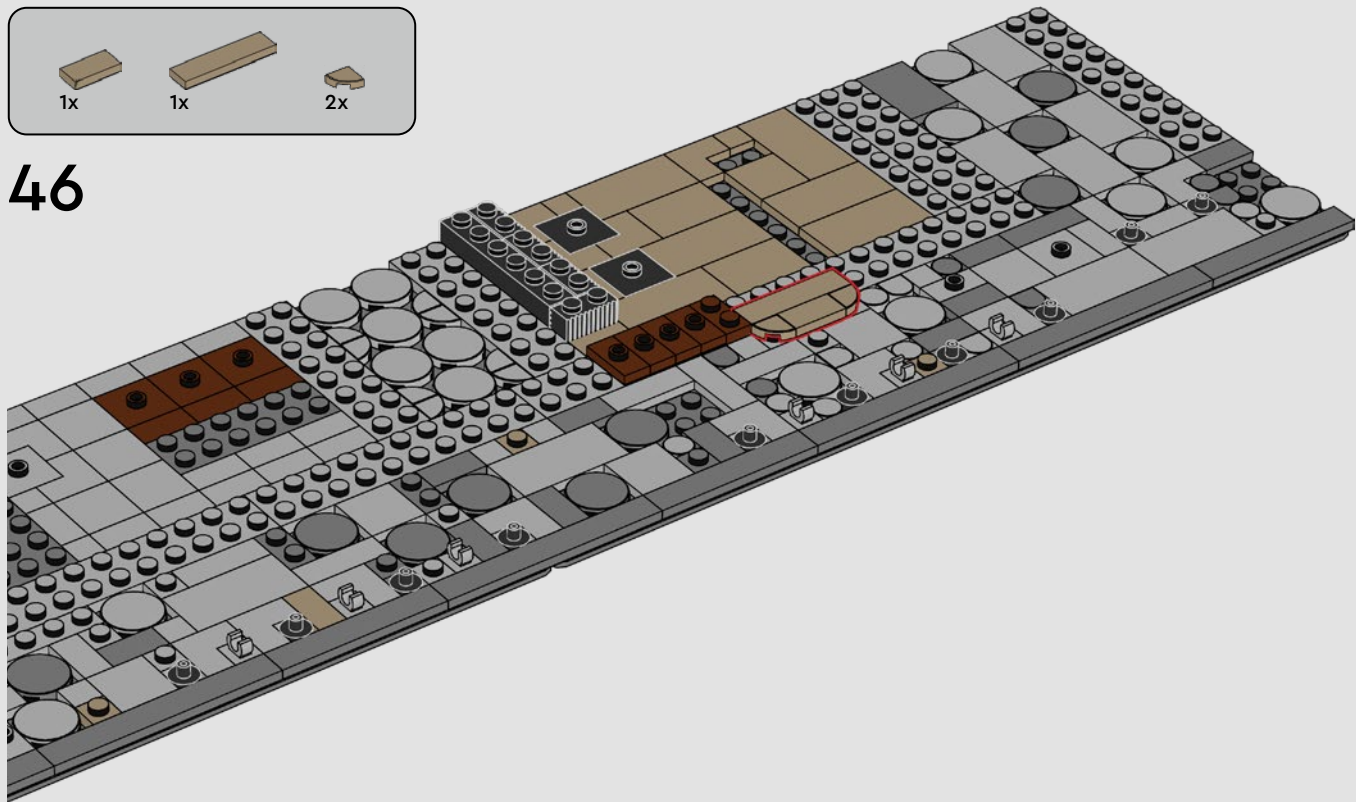



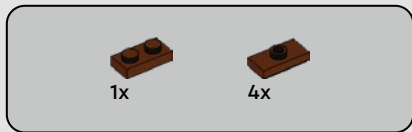

47

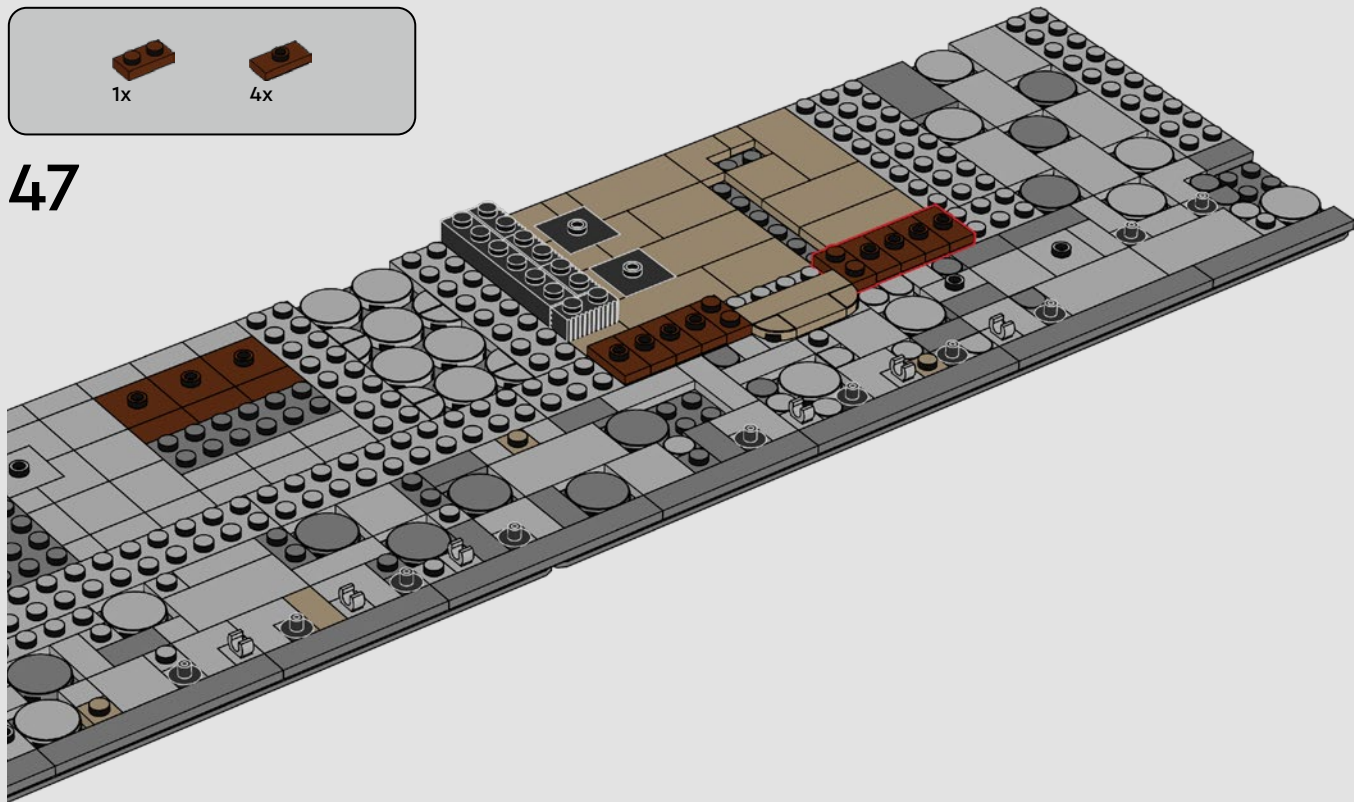



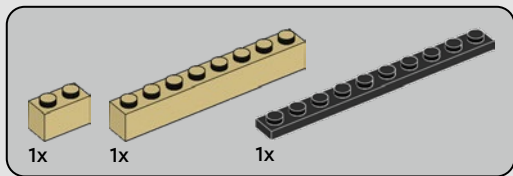

48

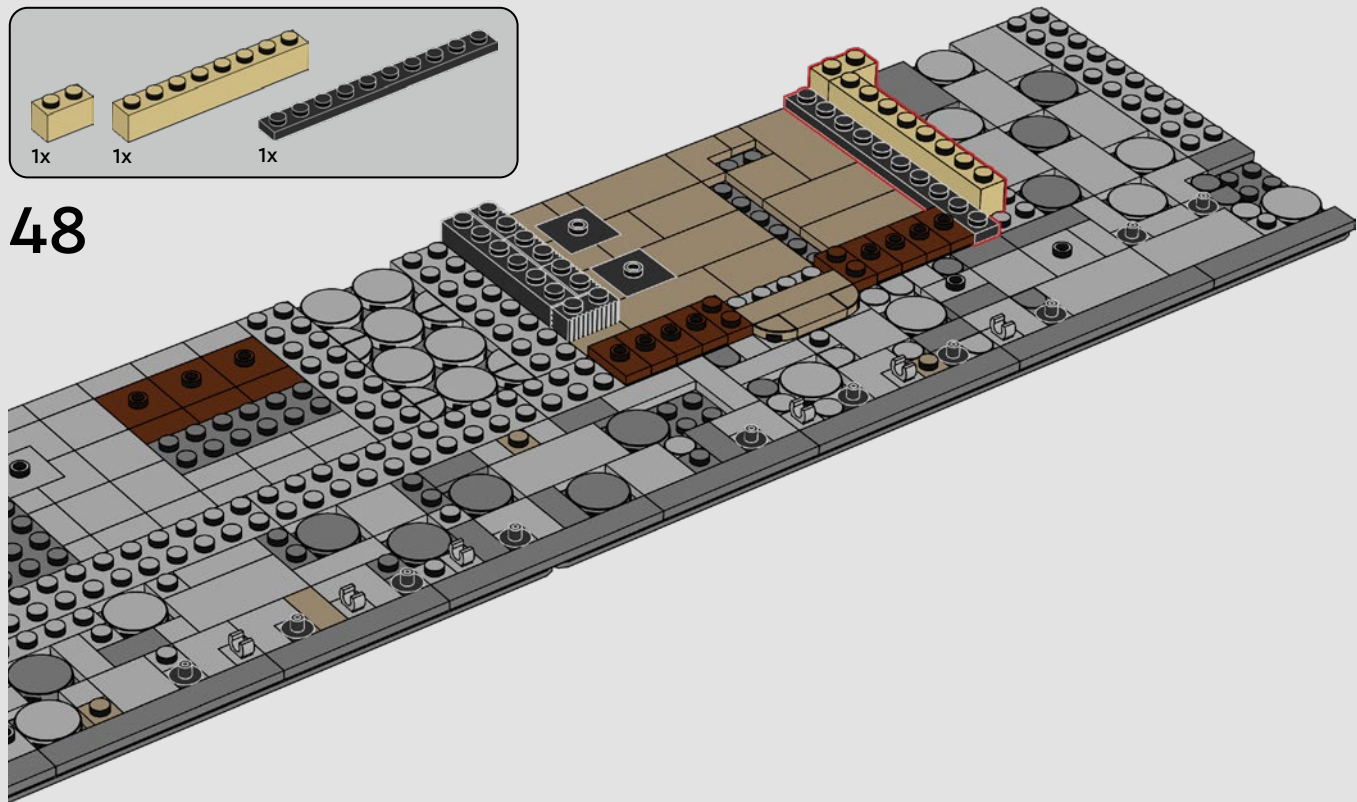

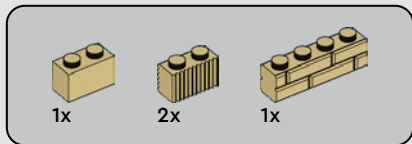

49

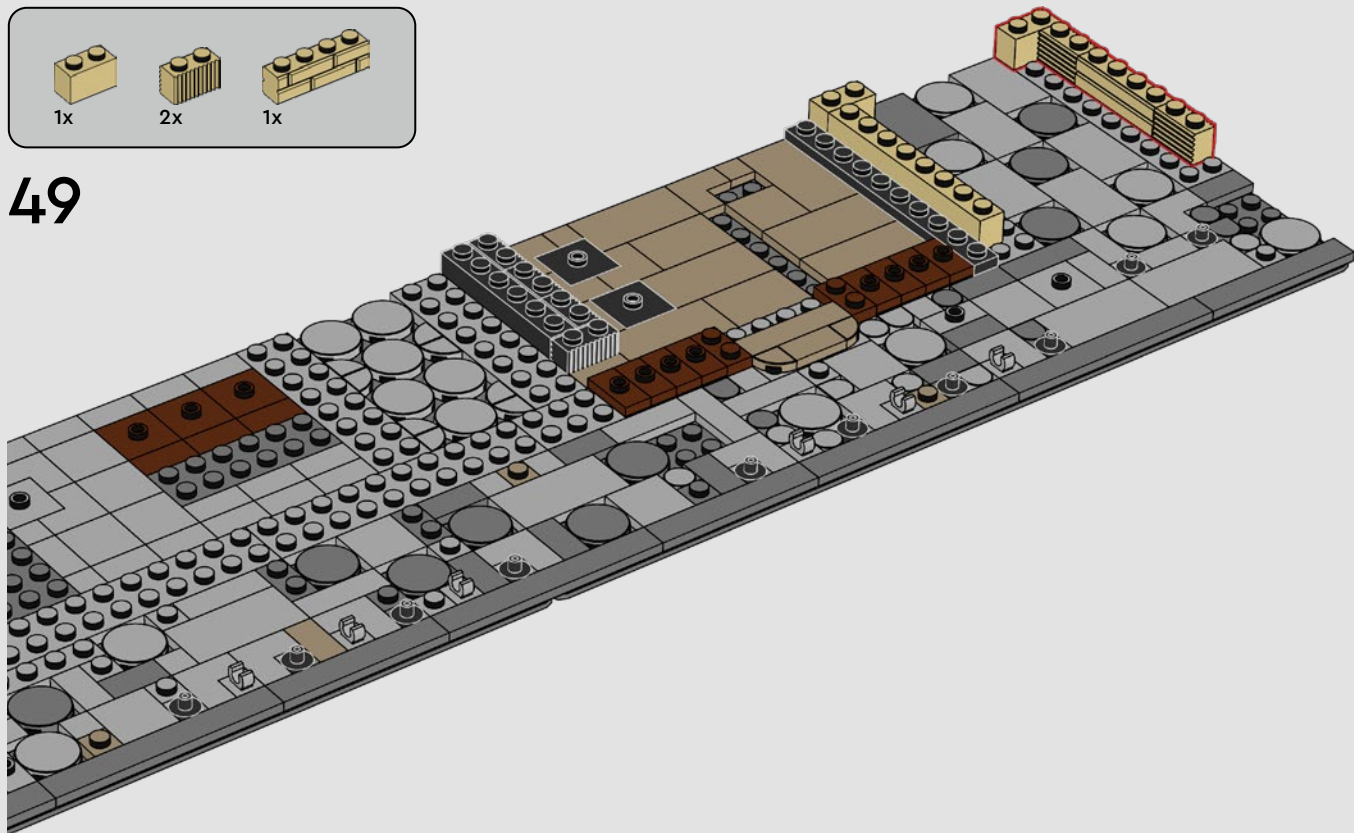

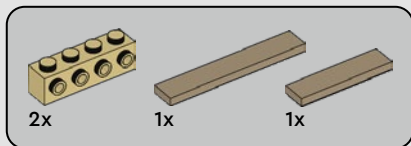

50

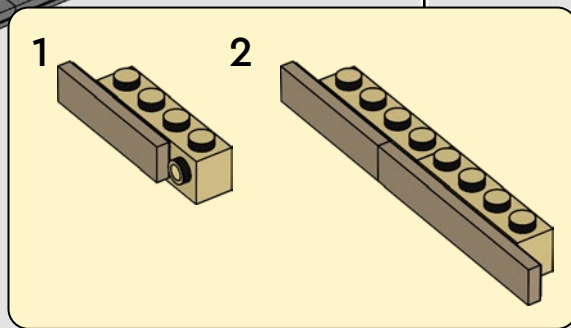
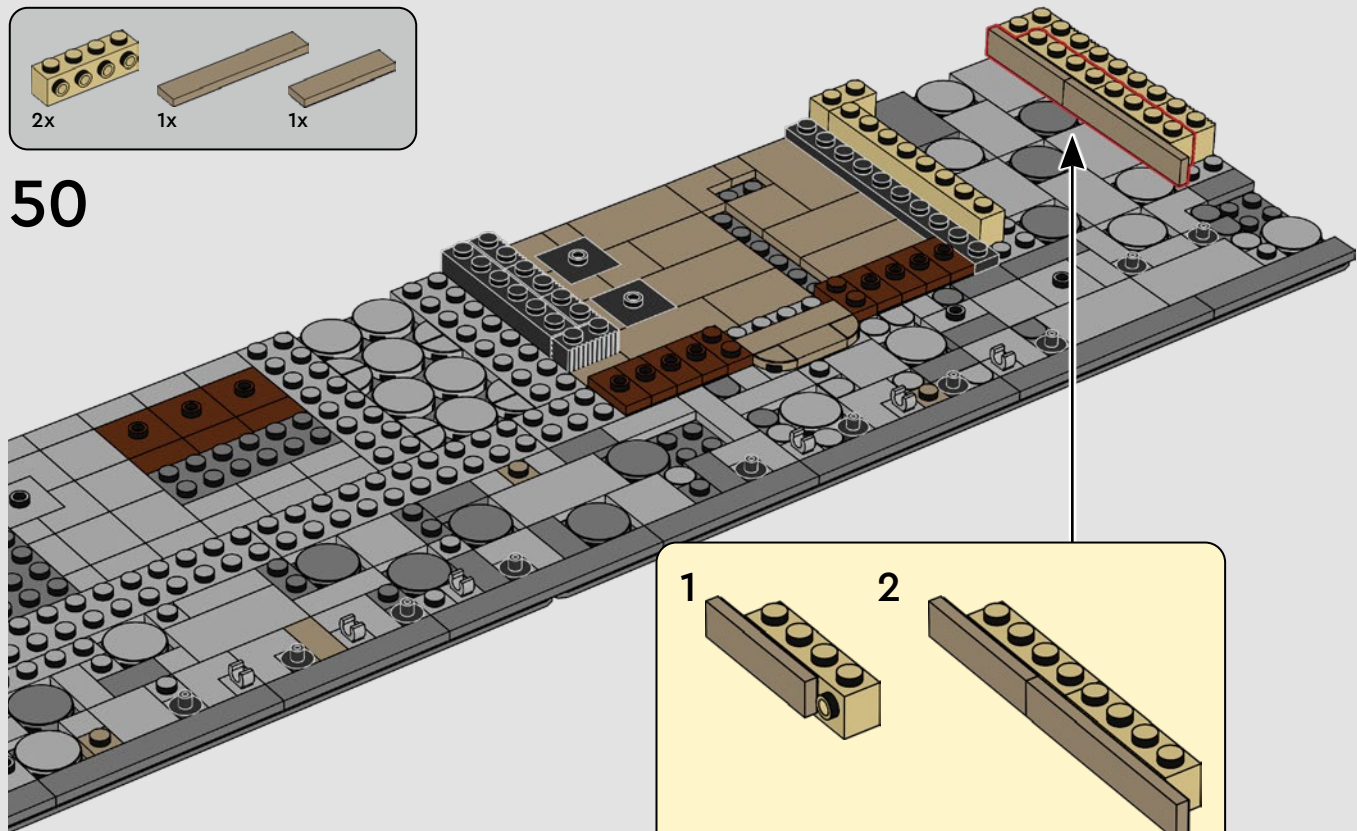

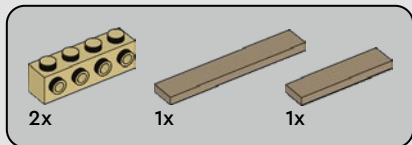

51

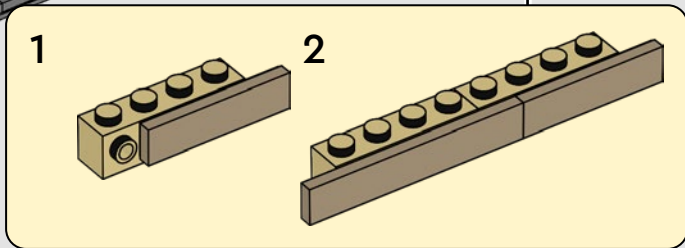
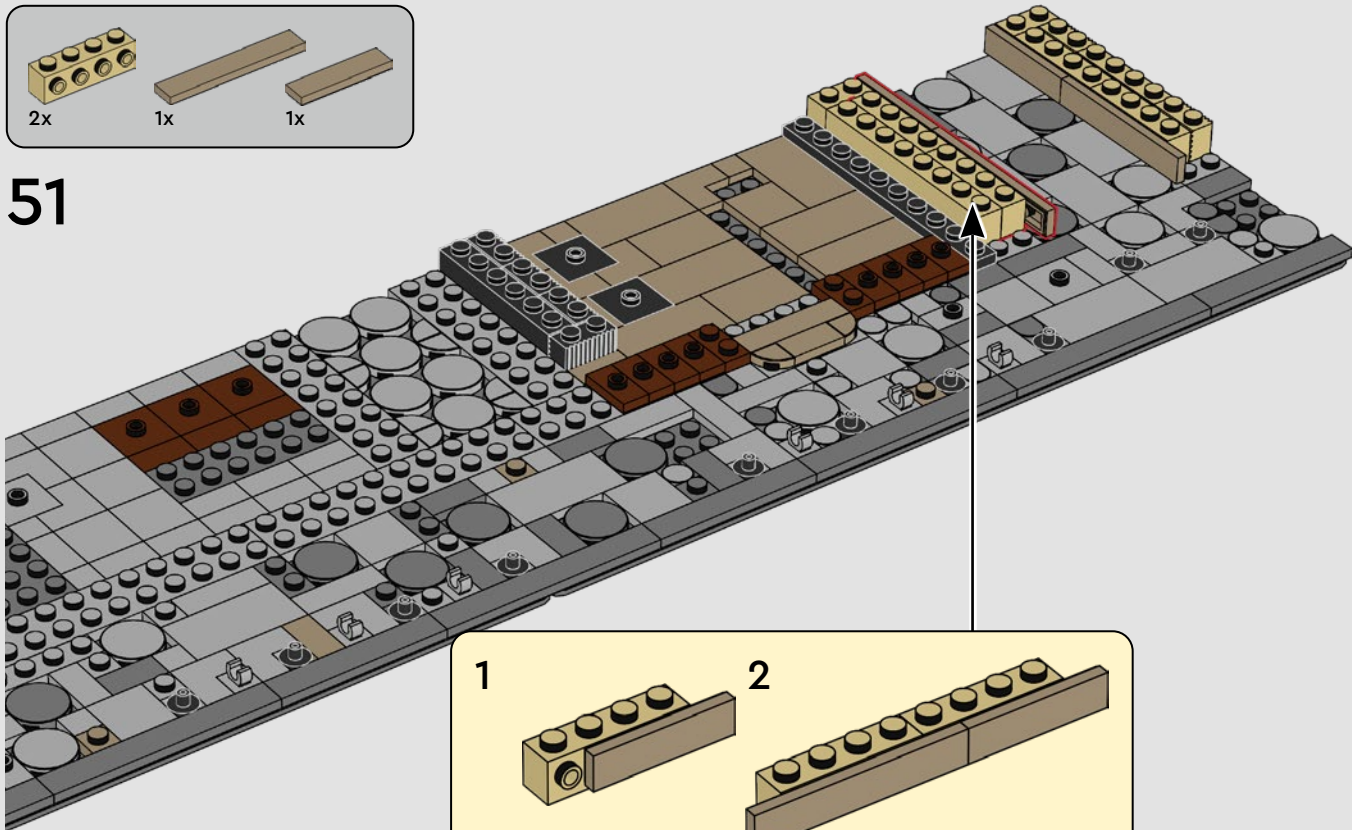

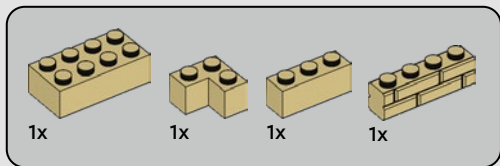

52

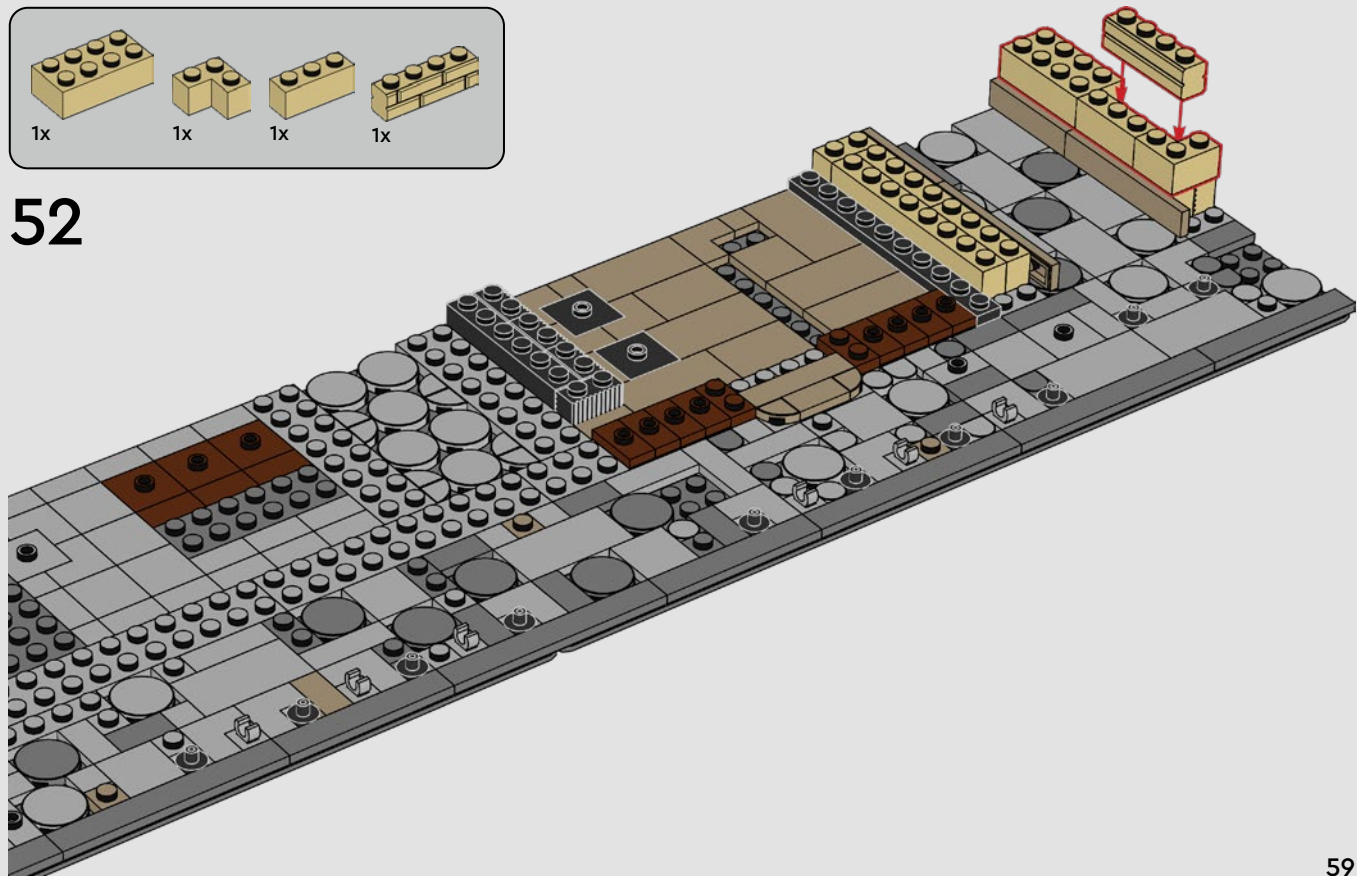



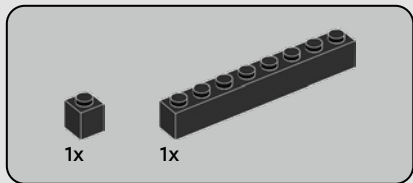

53

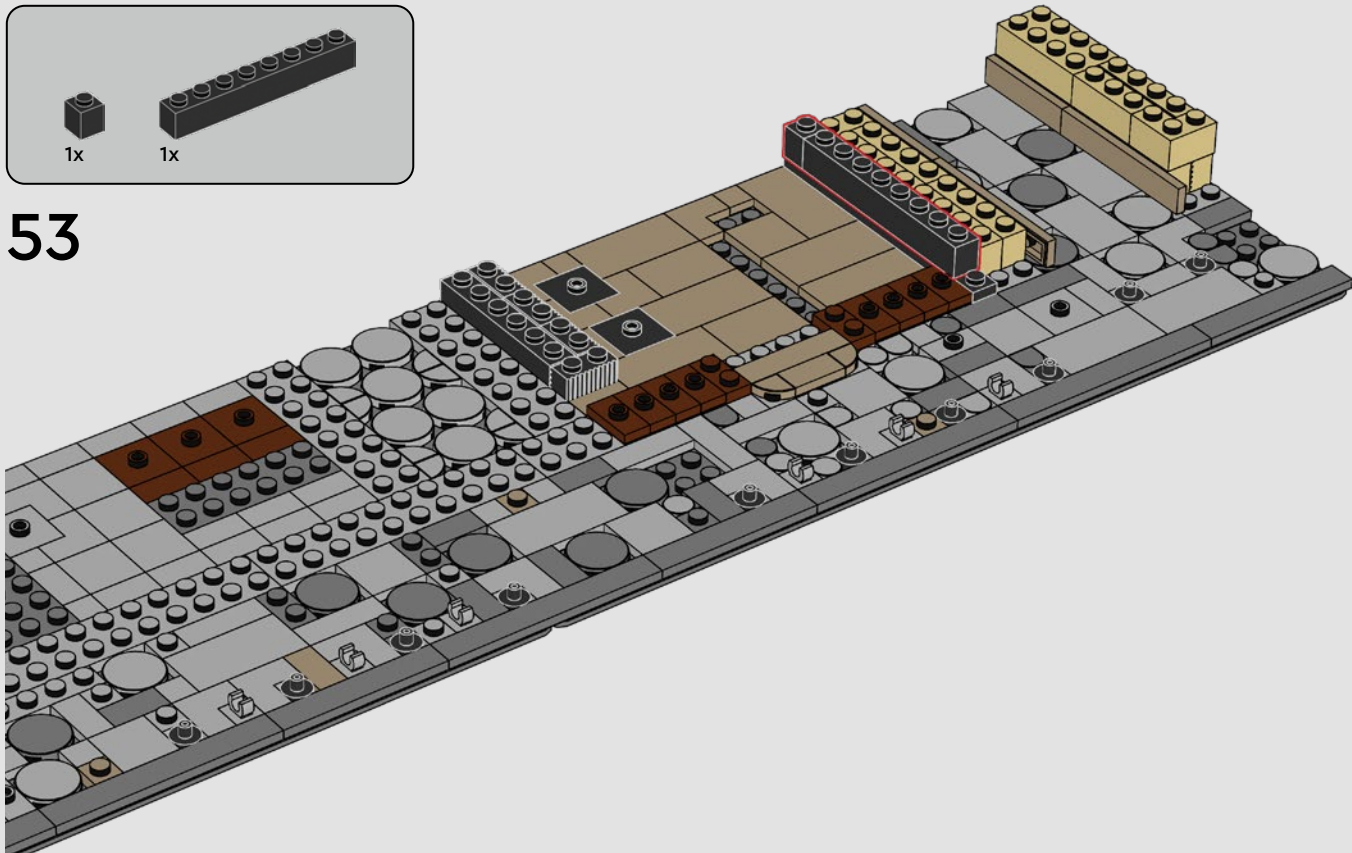



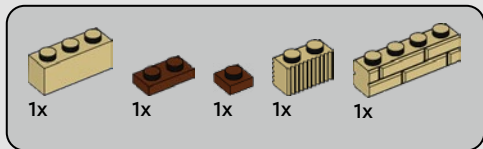

54

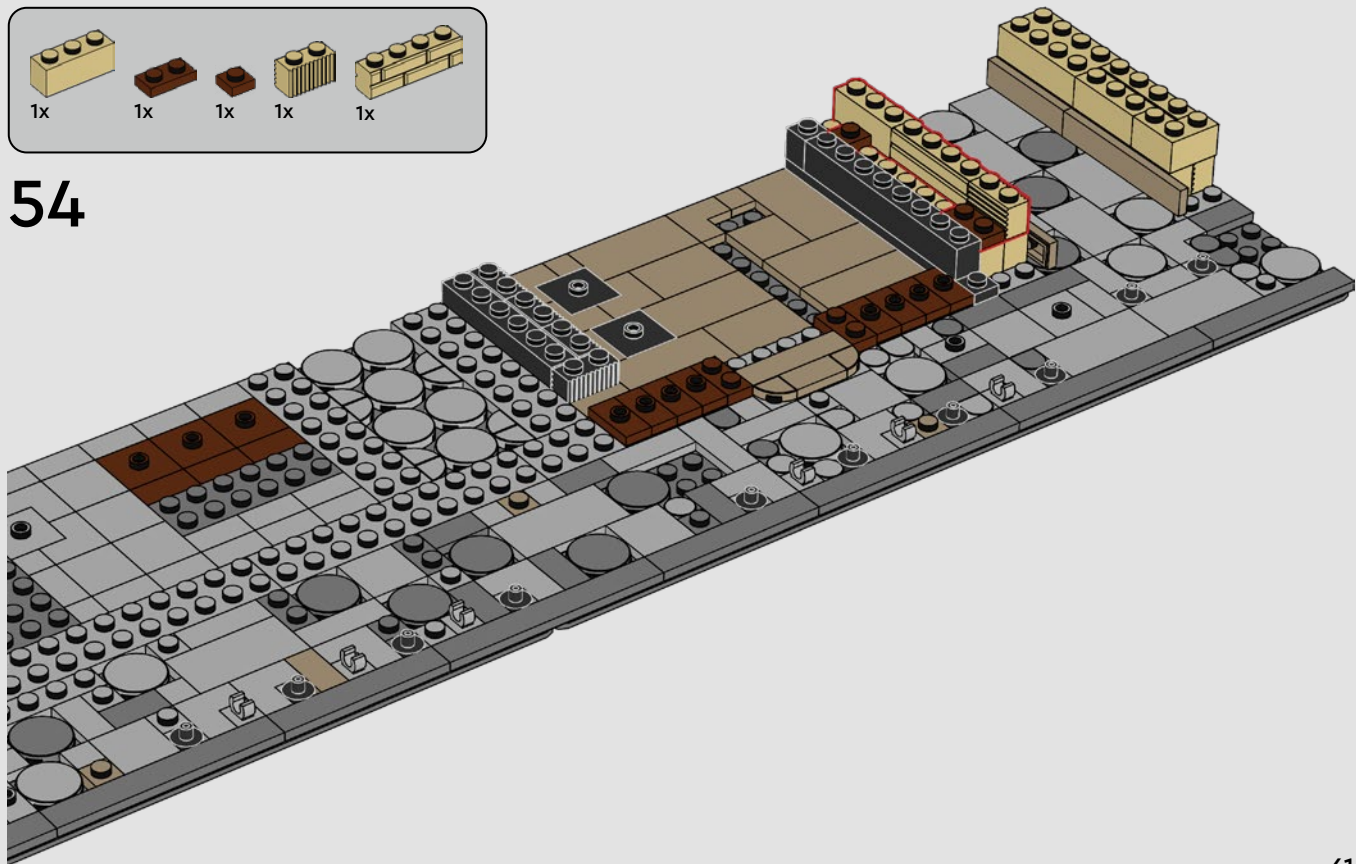



1x



1x

55

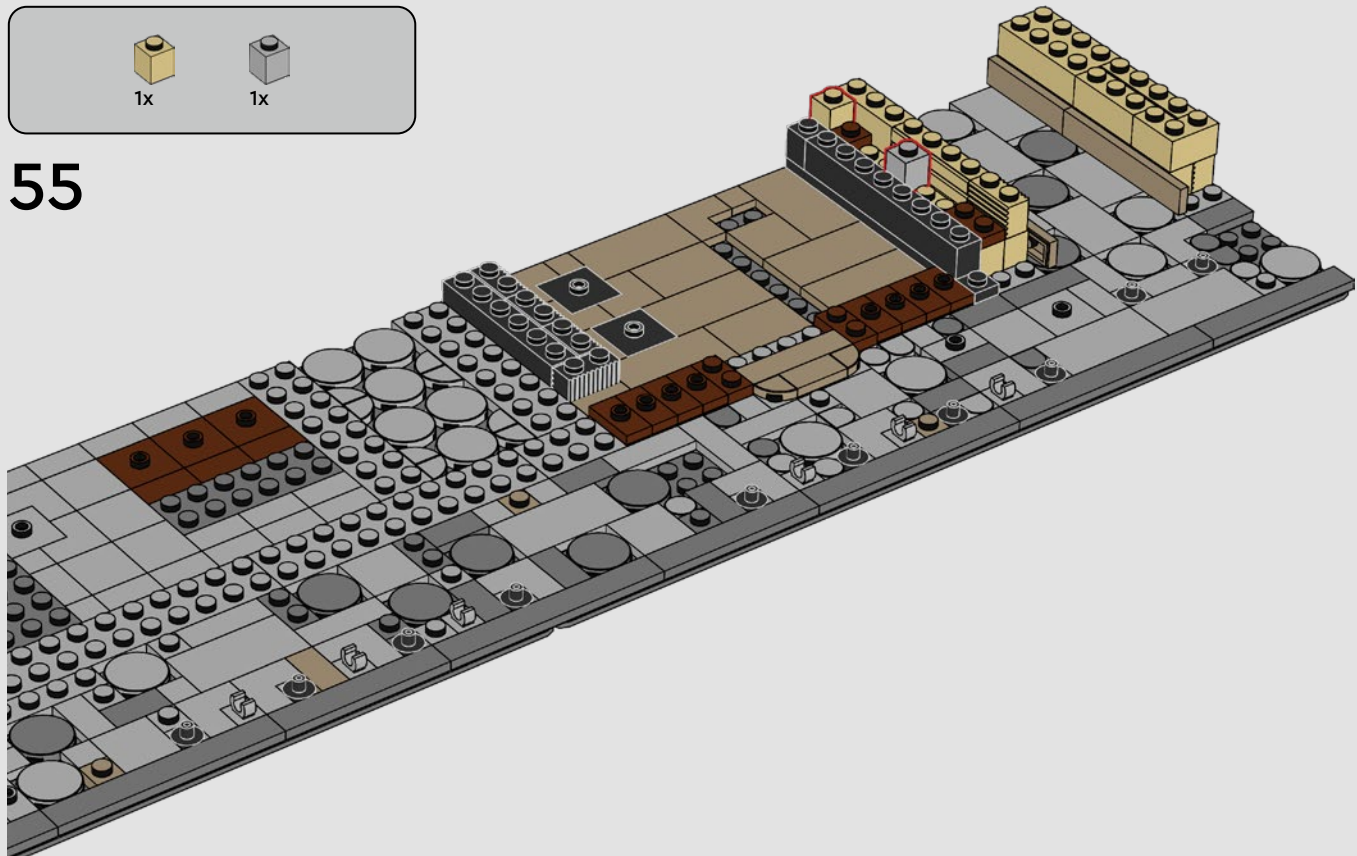

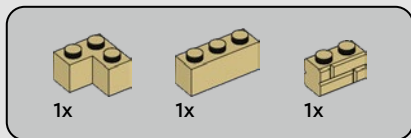

56

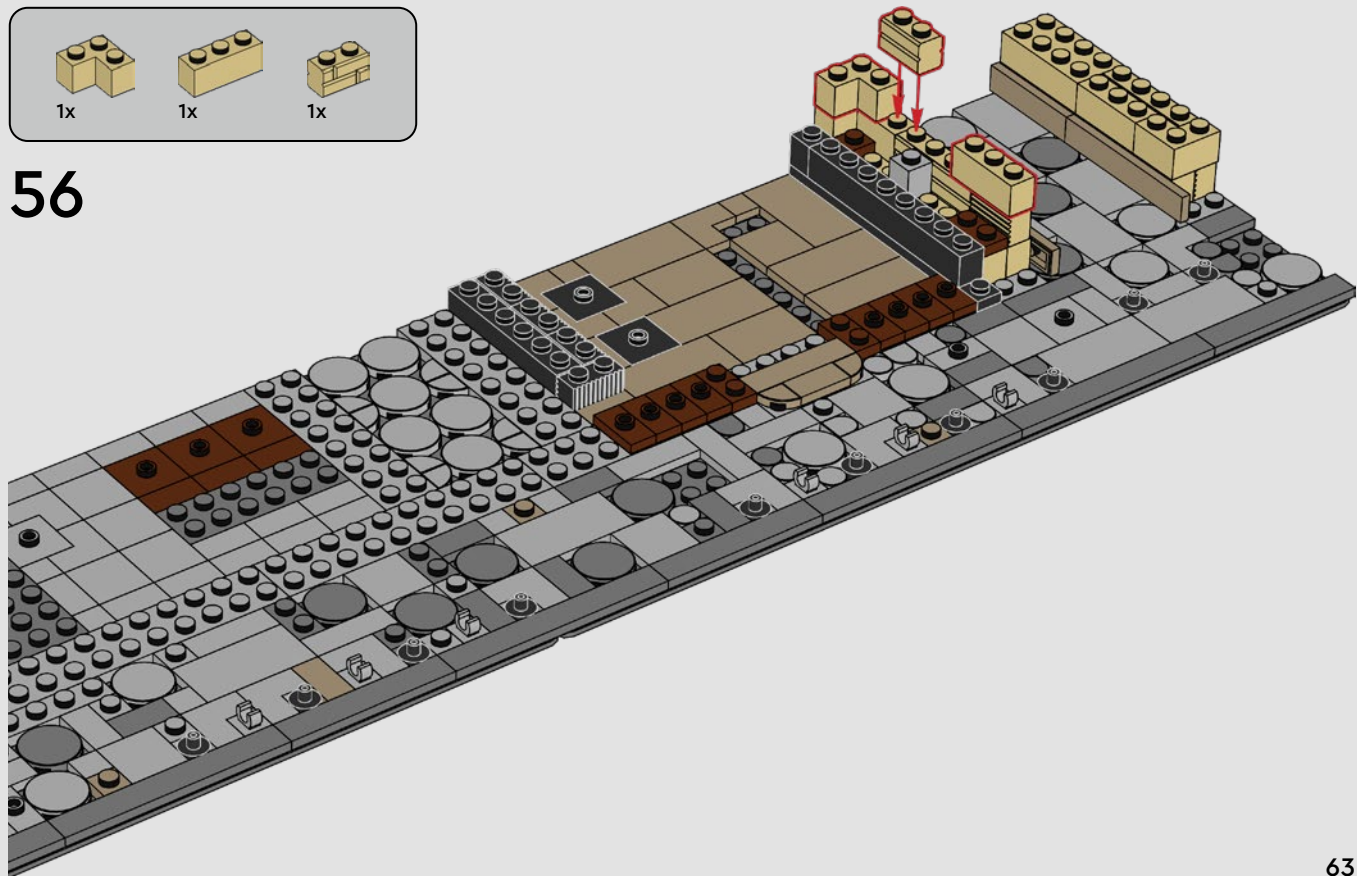

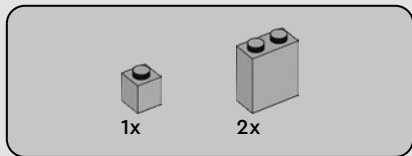

57

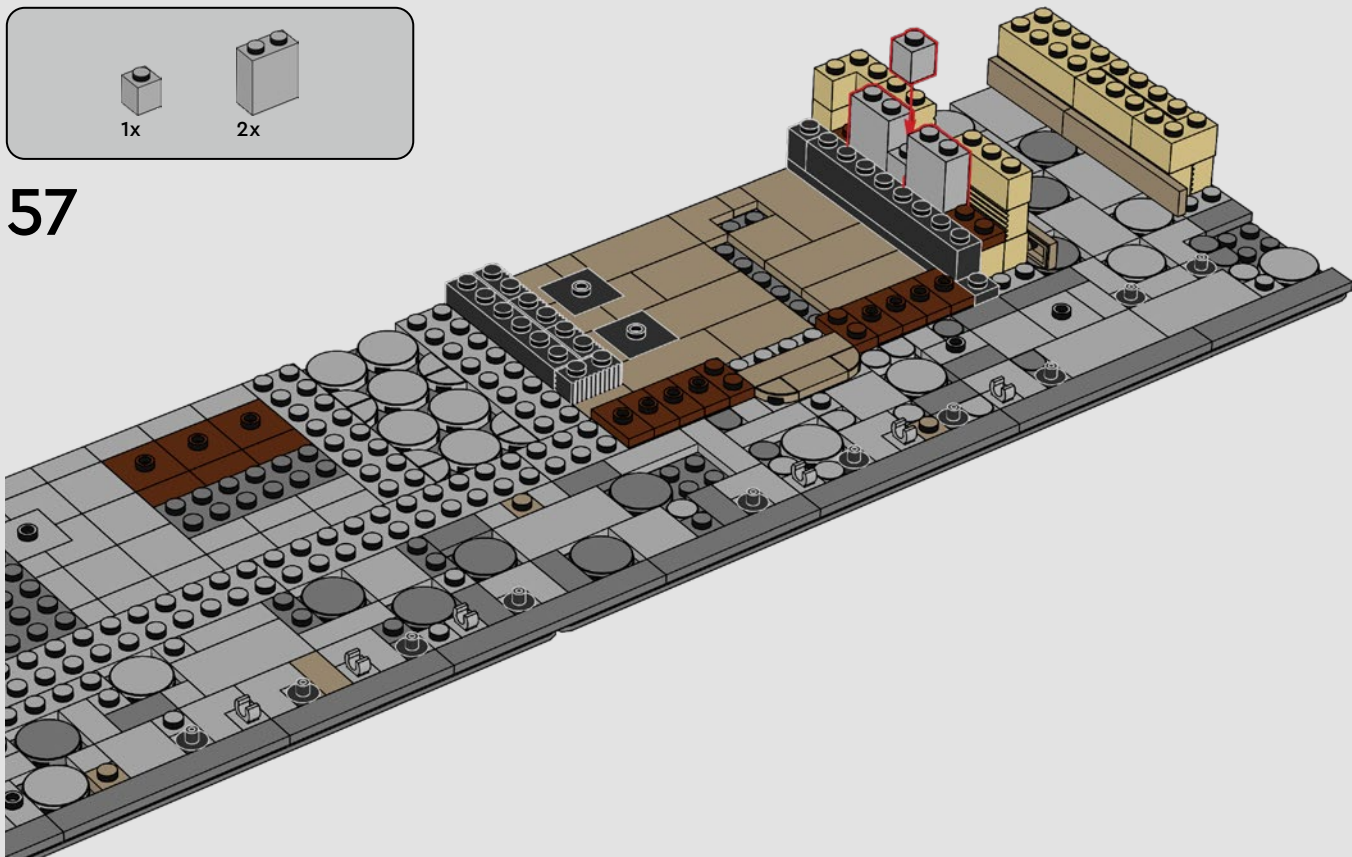

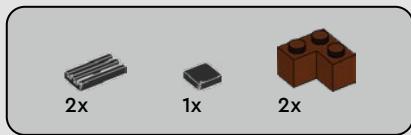

58

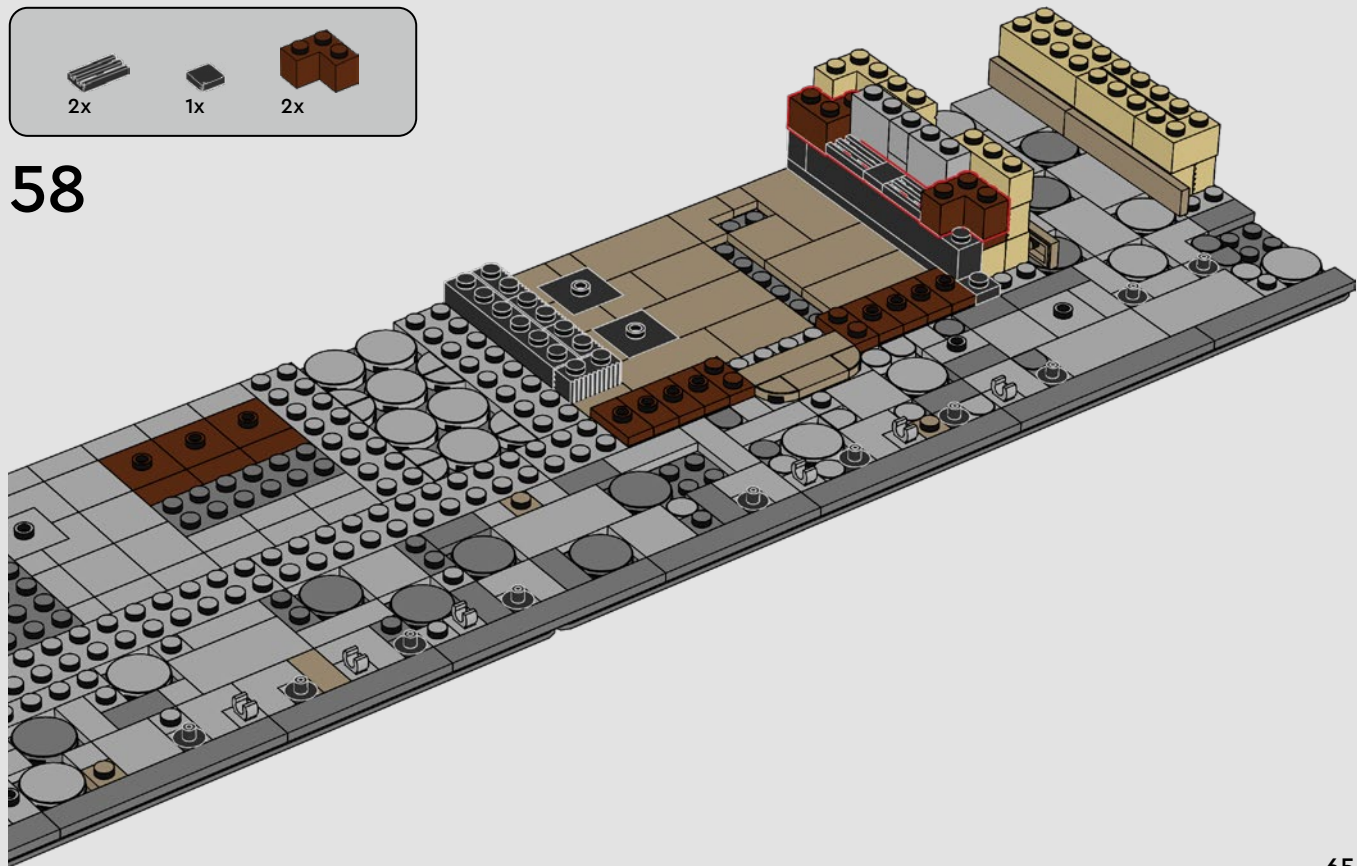



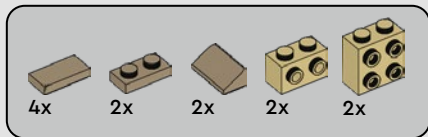

59

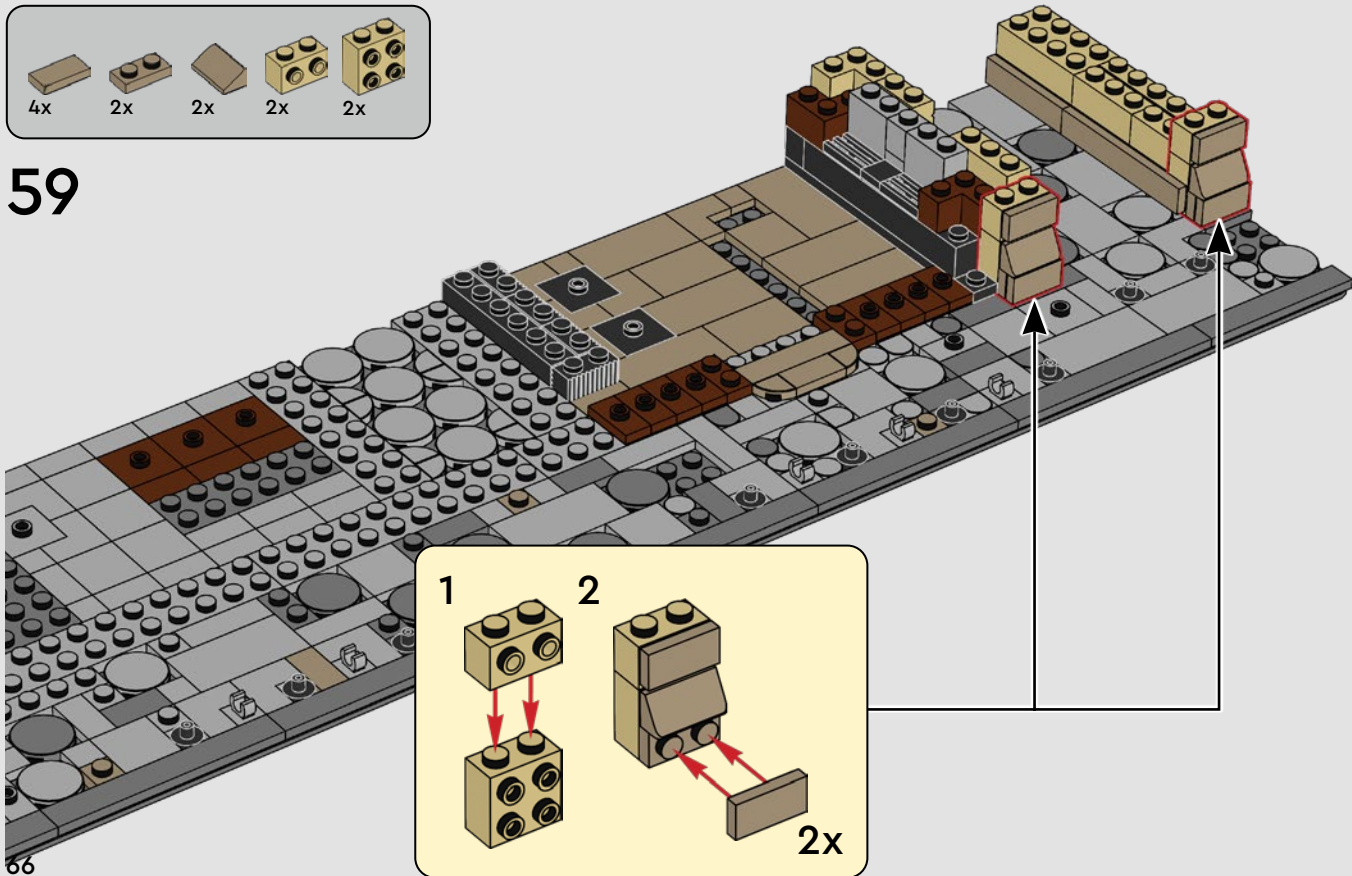



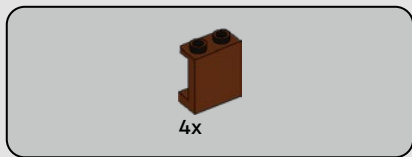

60

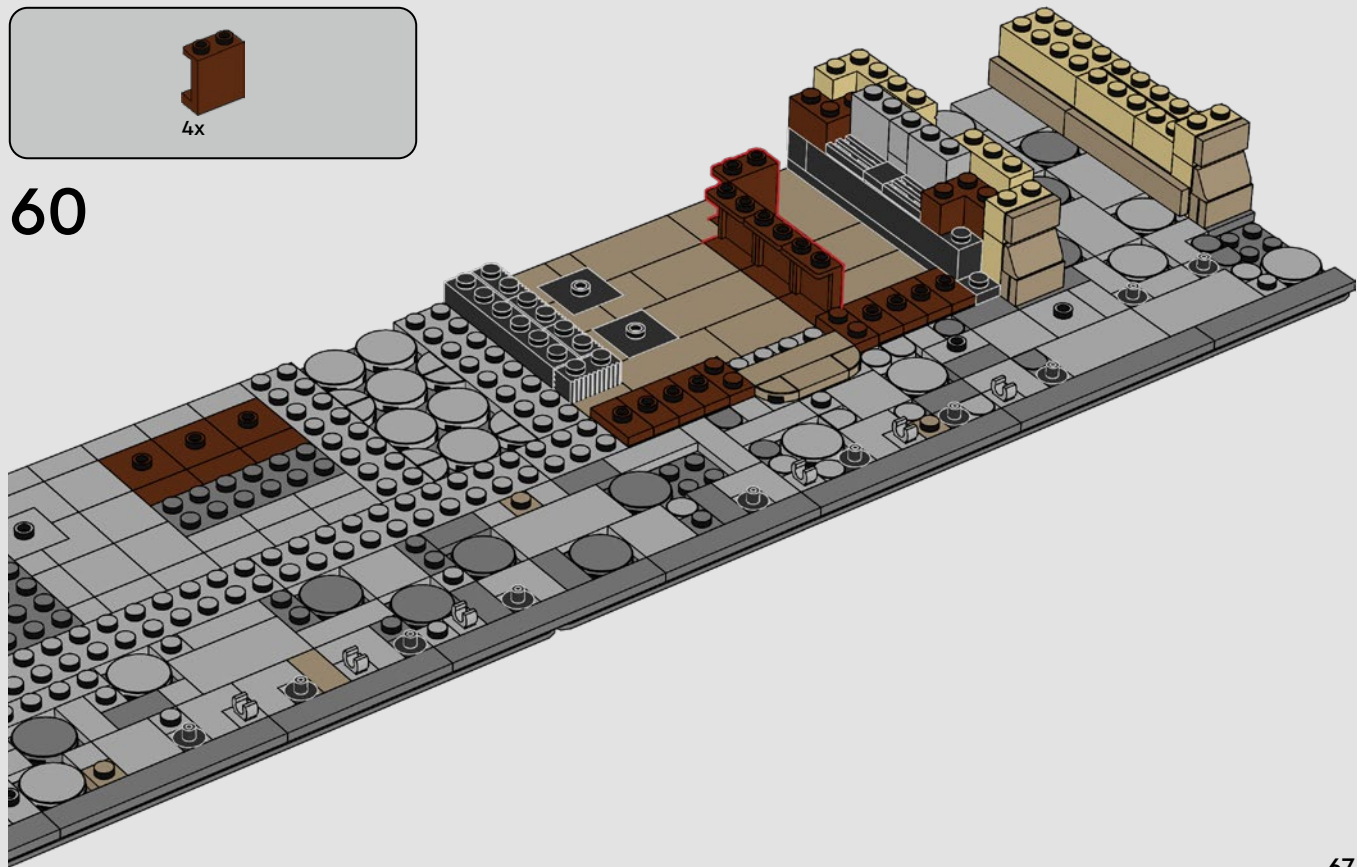

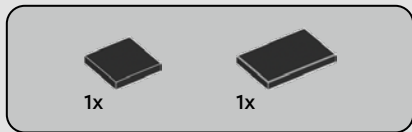

61

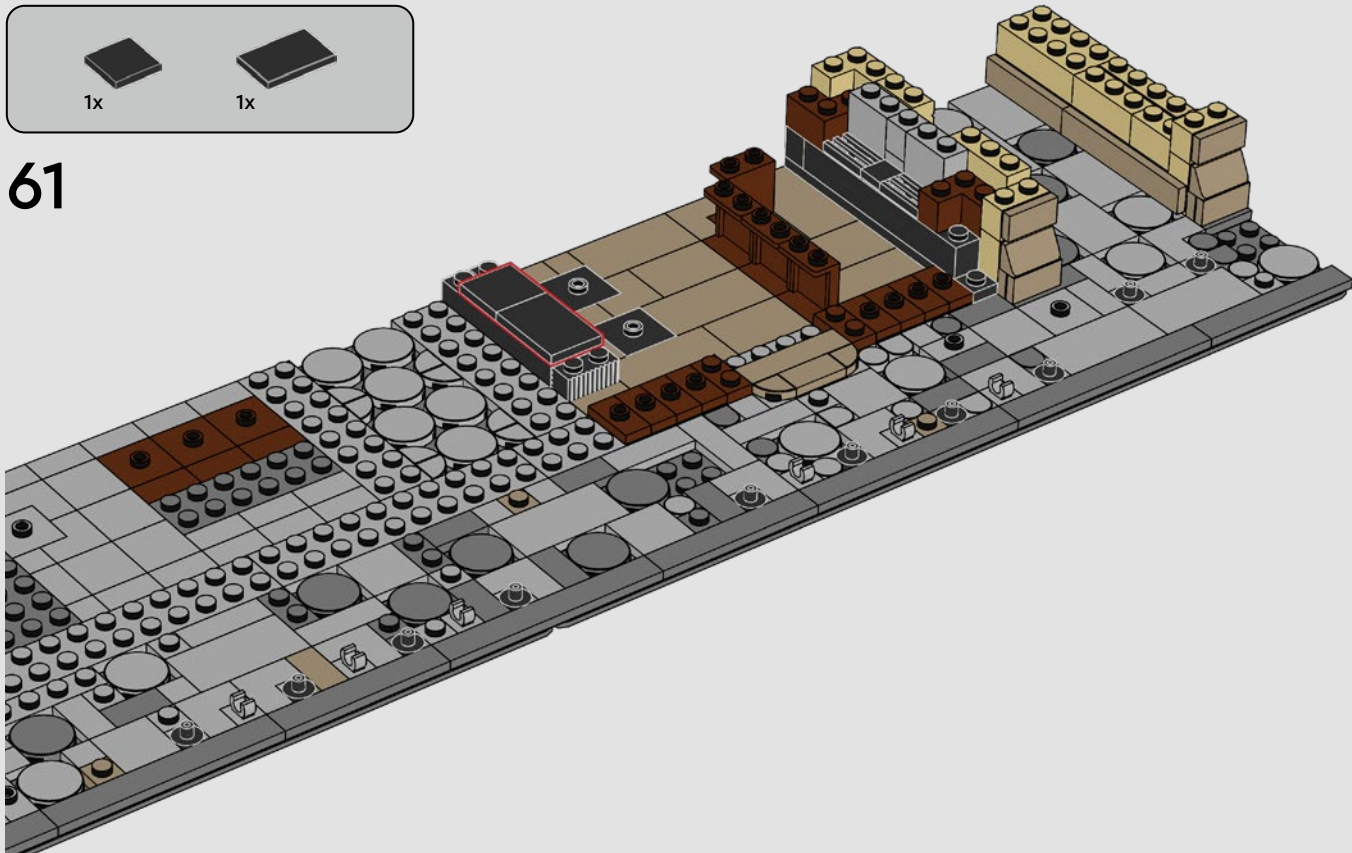

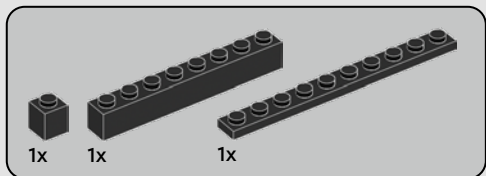

62

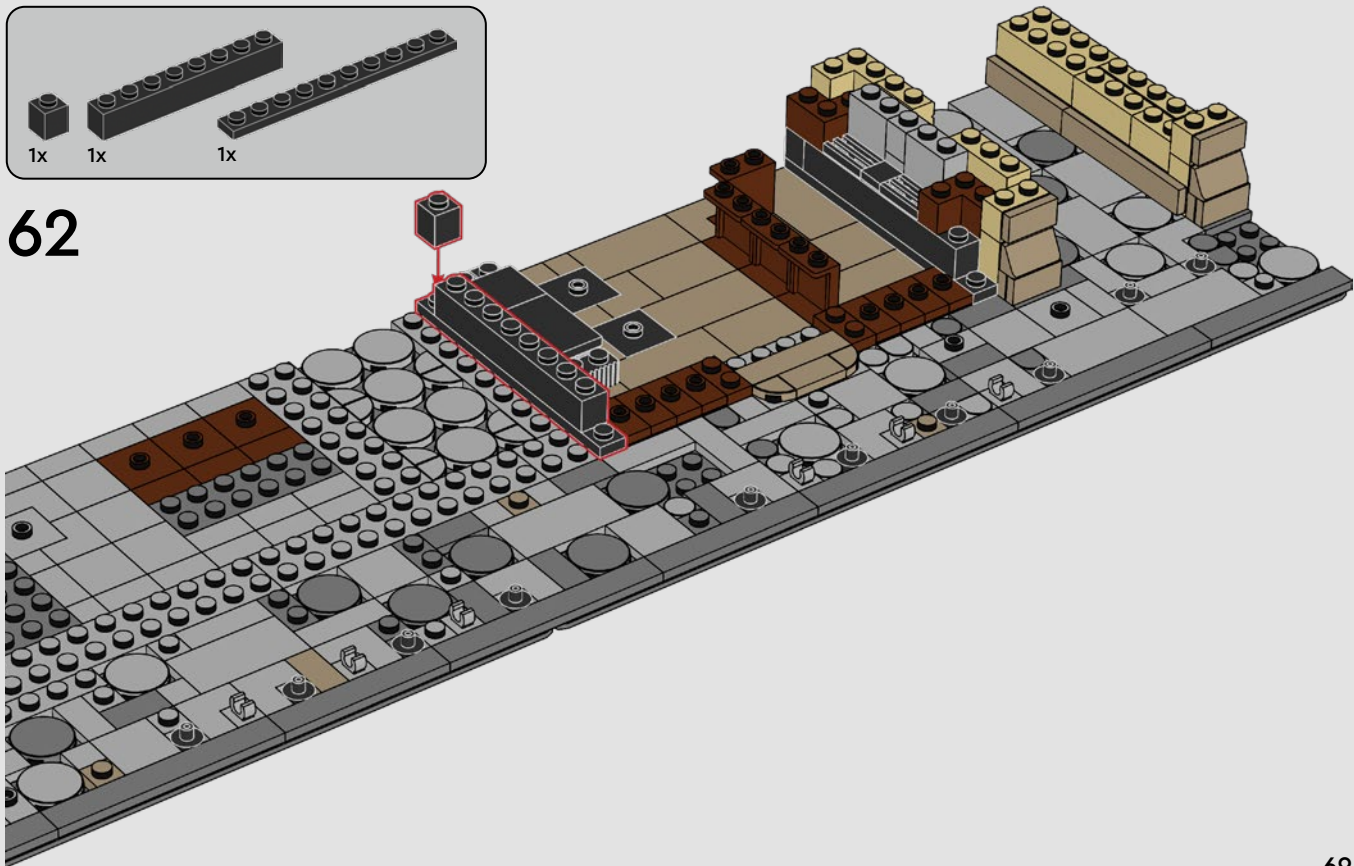

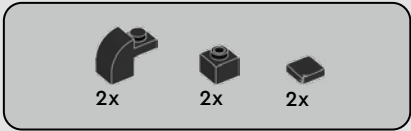

63

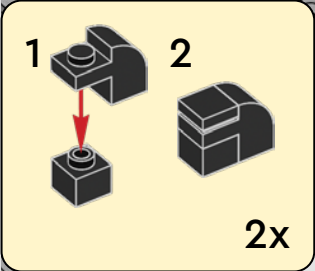
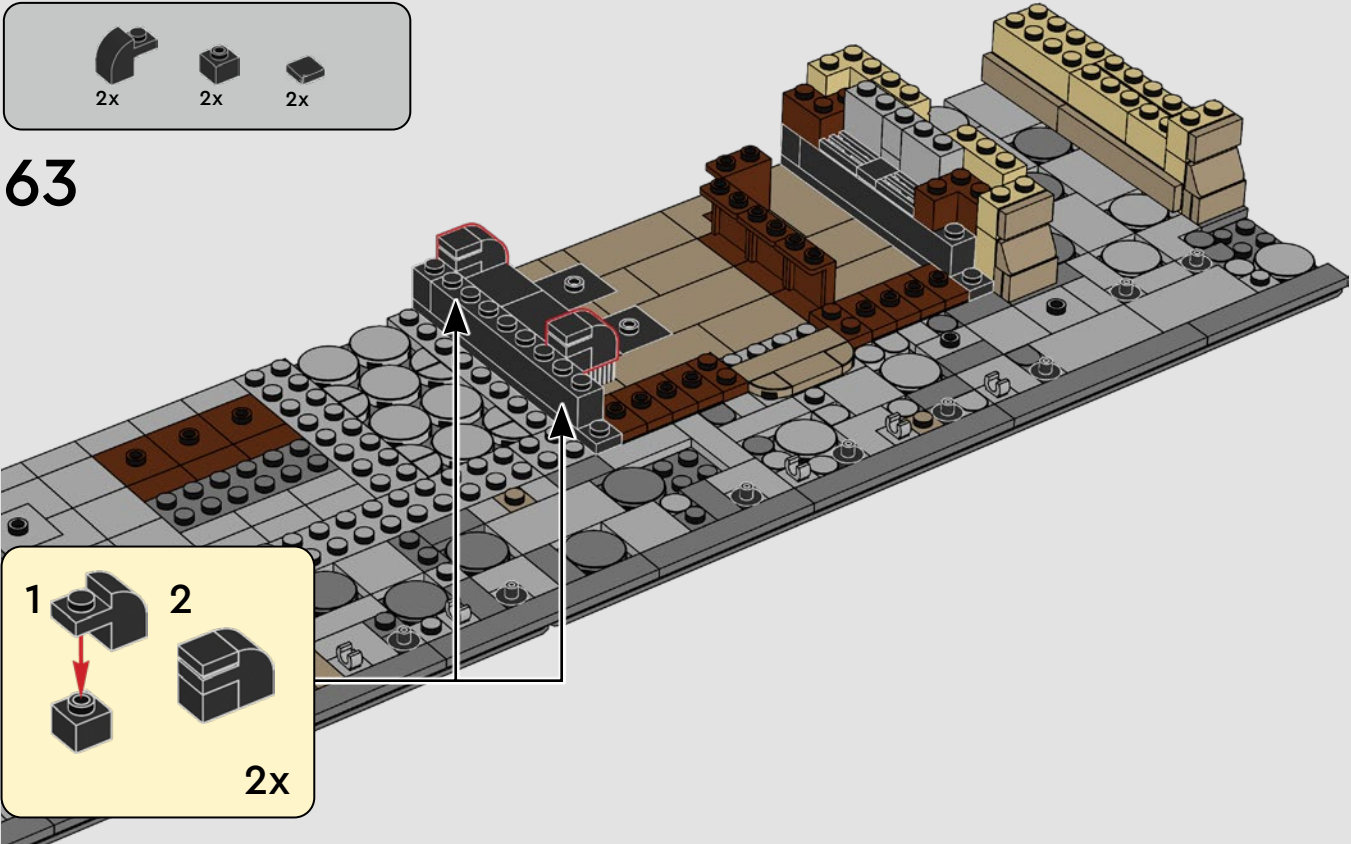



64

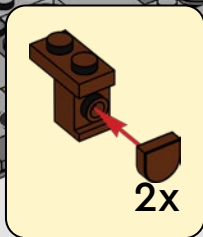
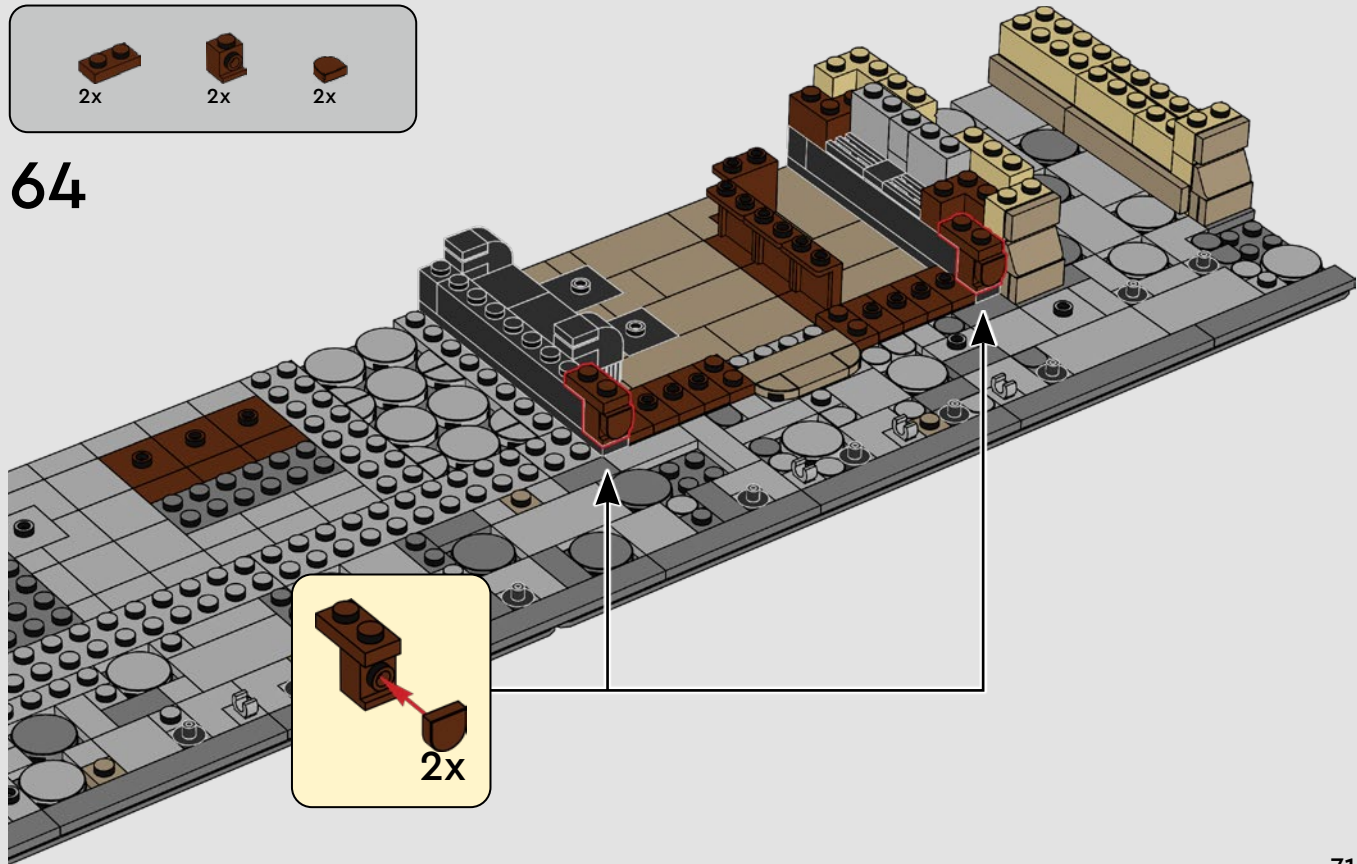



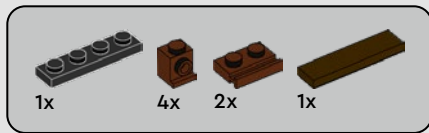

65

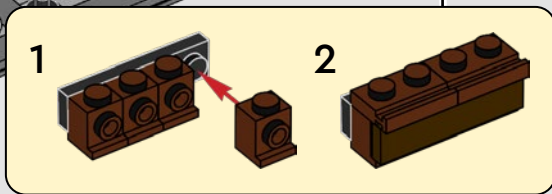
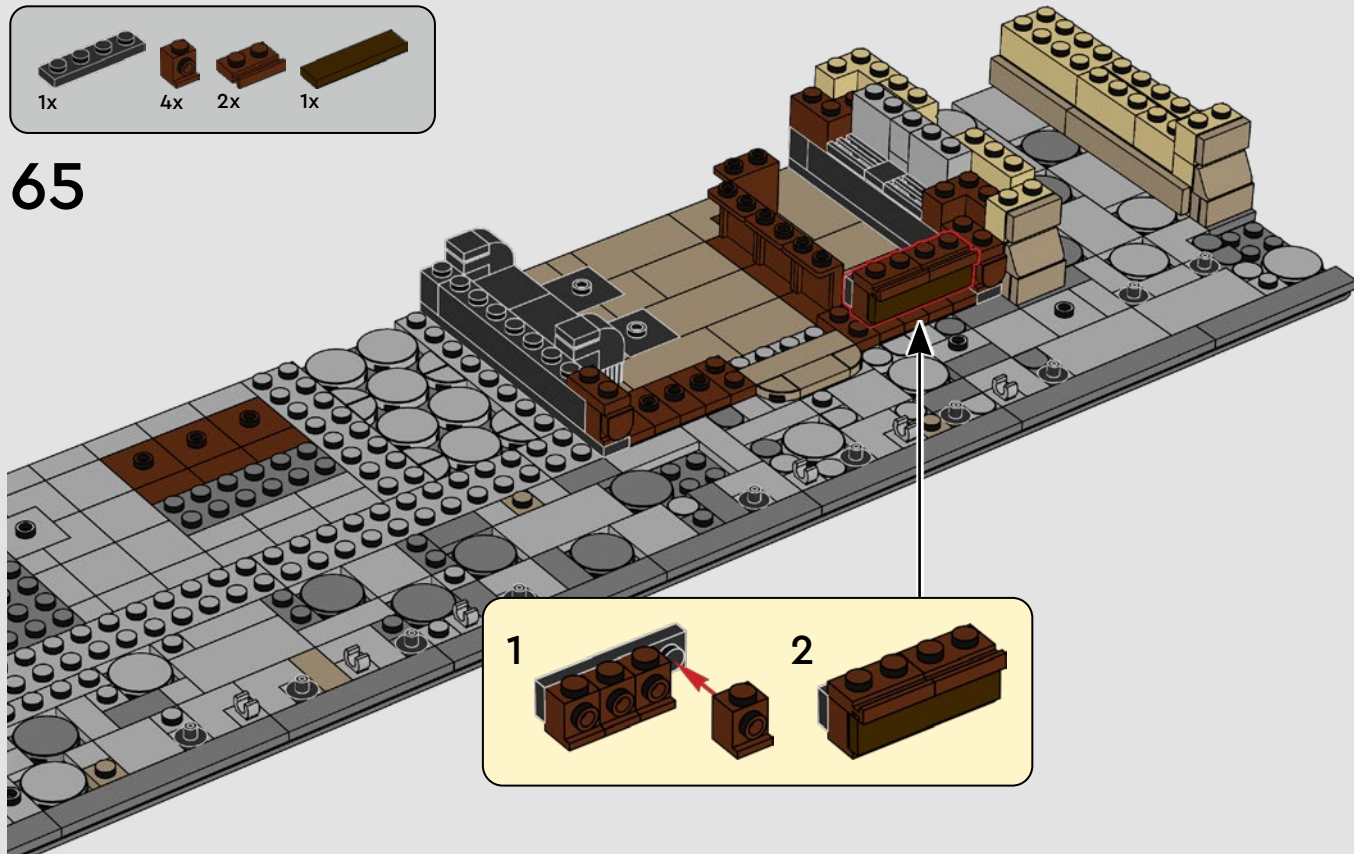

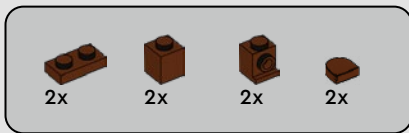

66

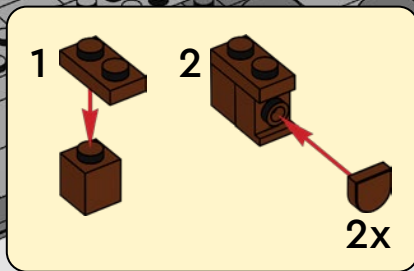
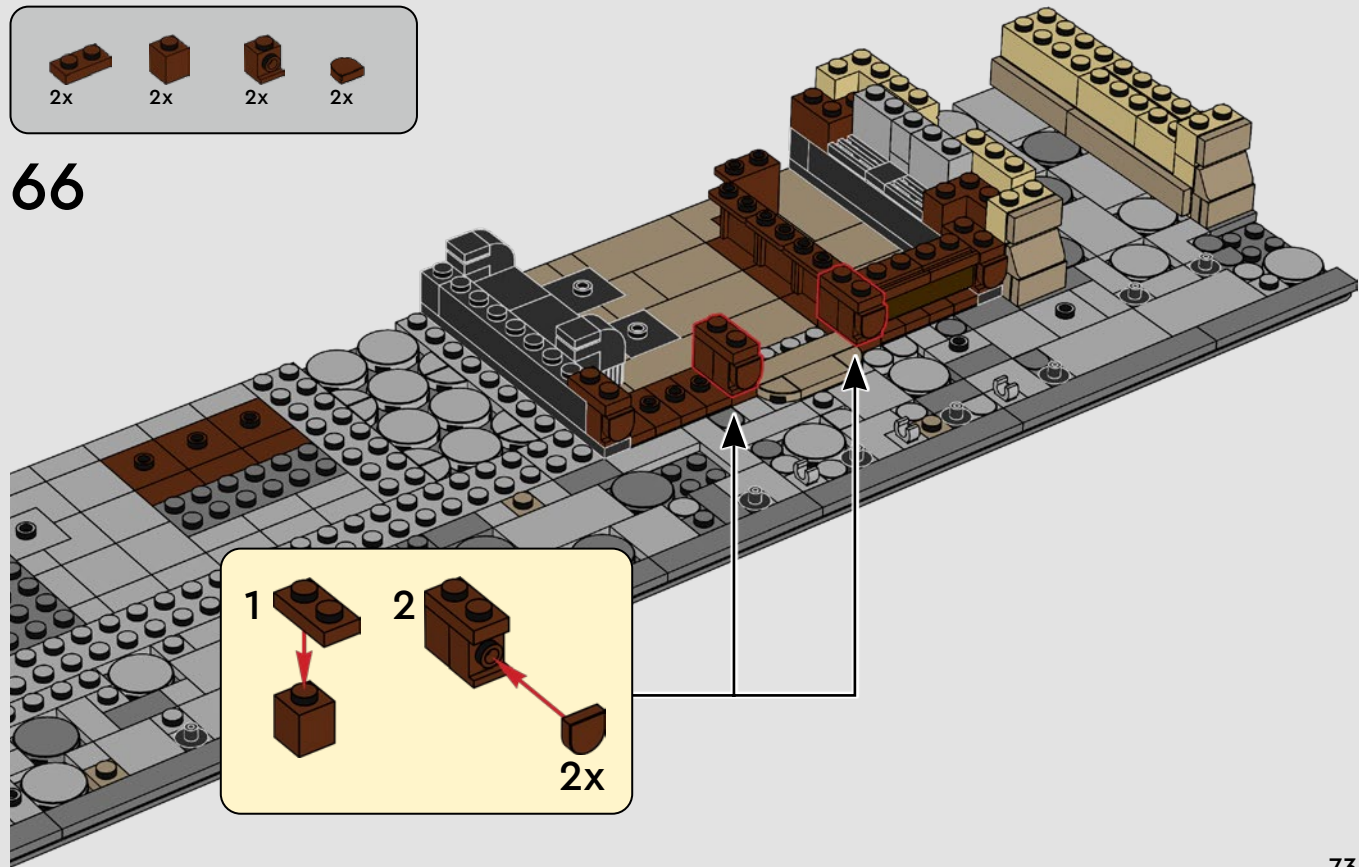

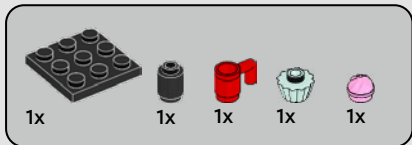

67

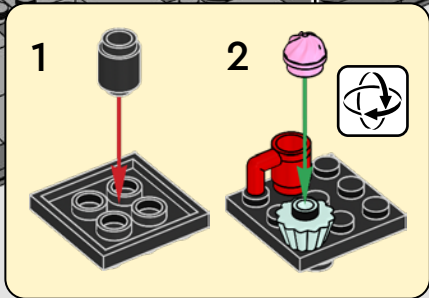
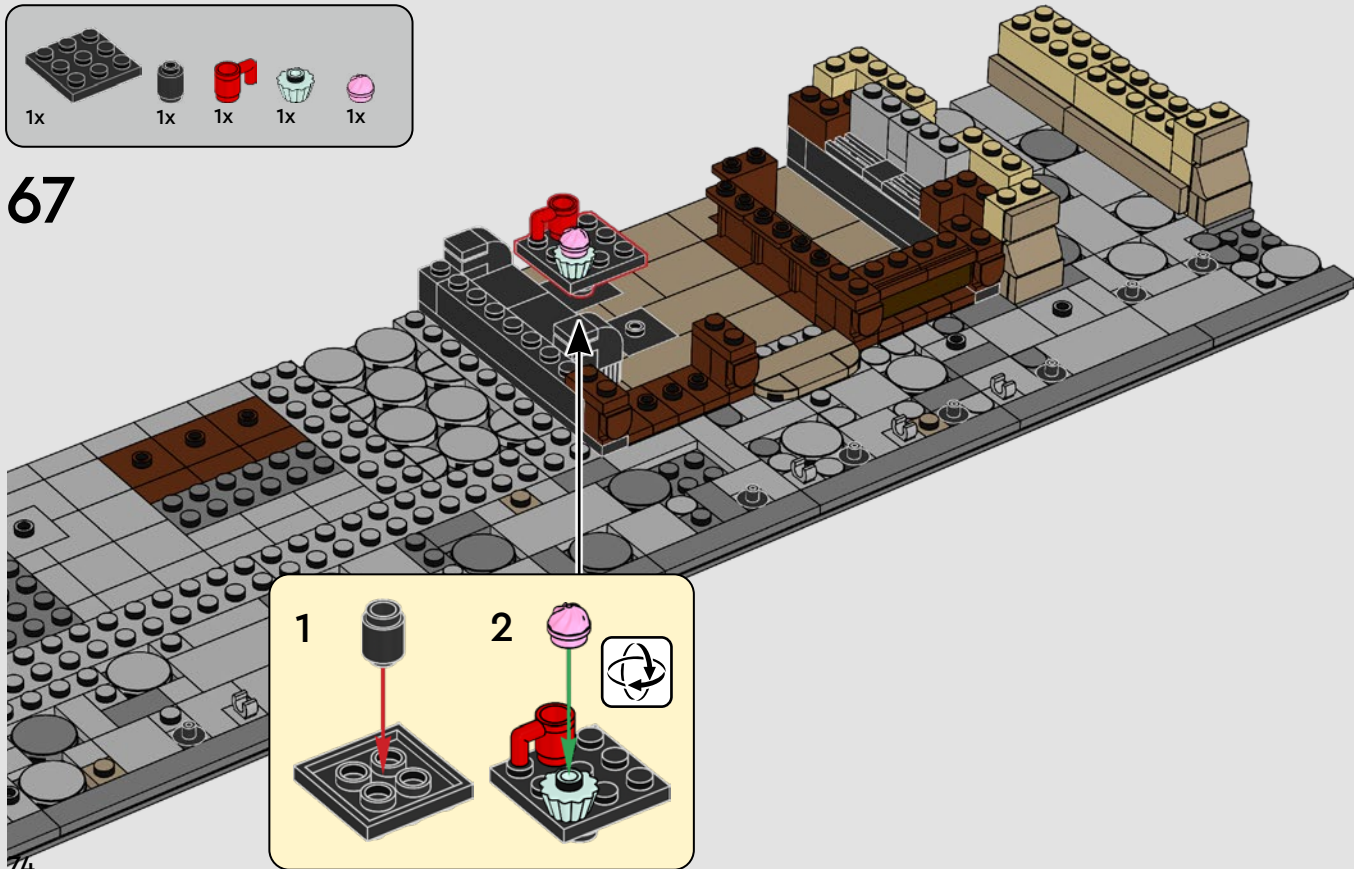

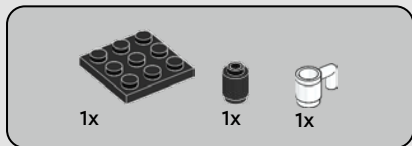

68

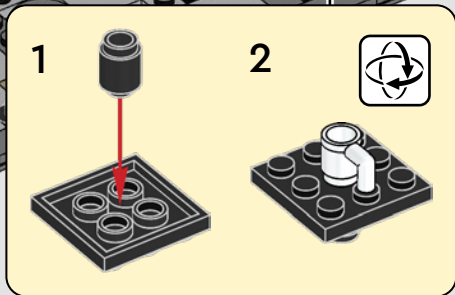
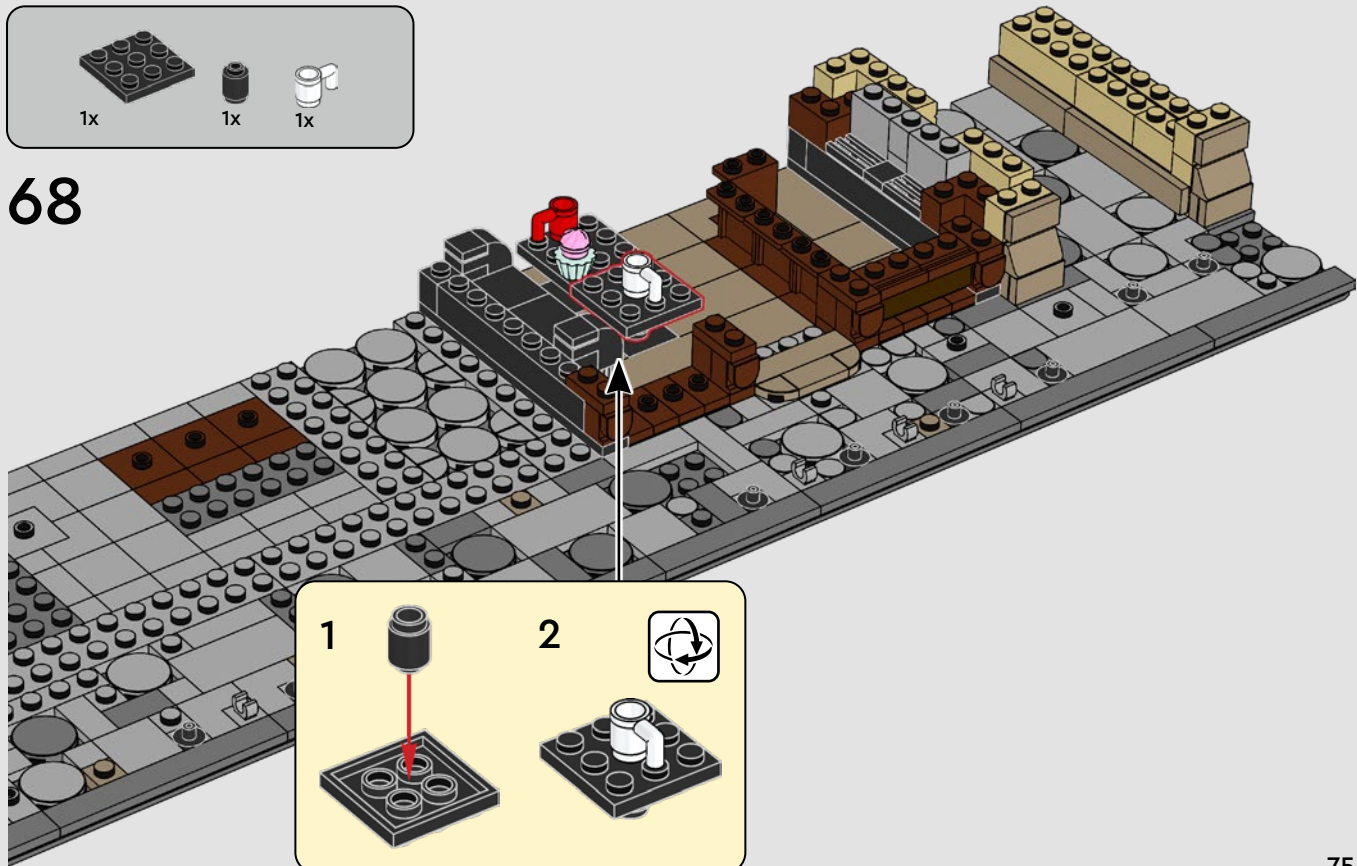

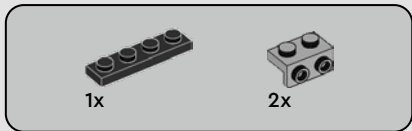

69

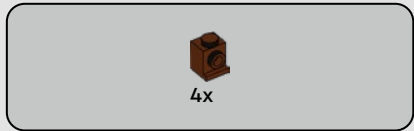
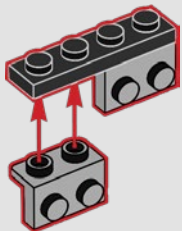

70

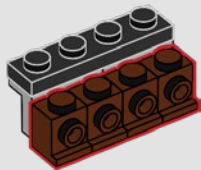



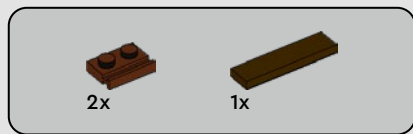

71

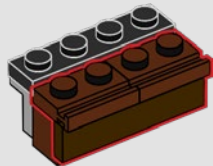

72



73

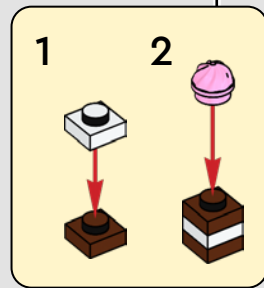

74

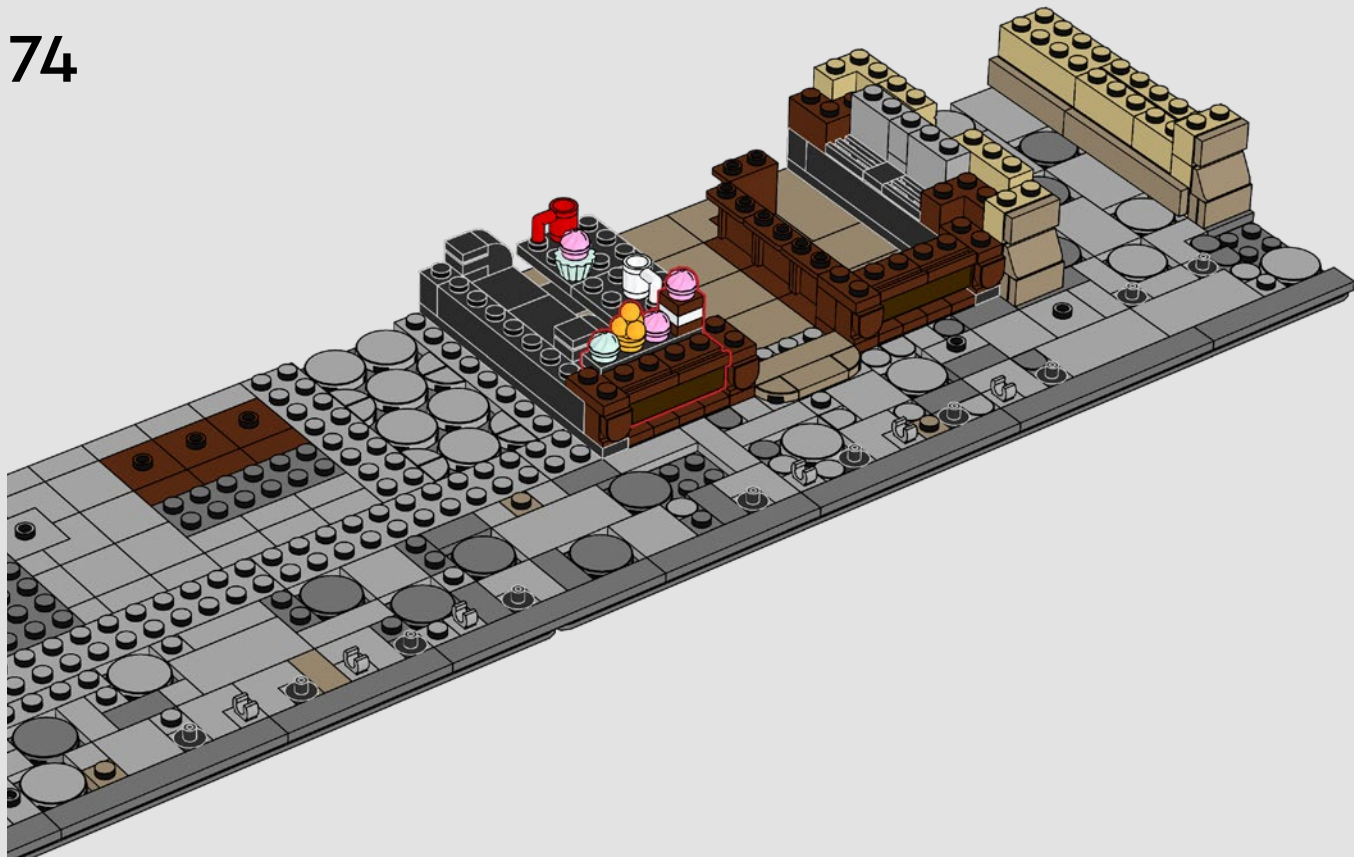

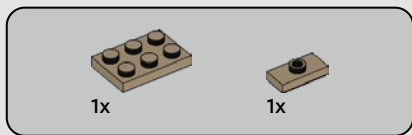
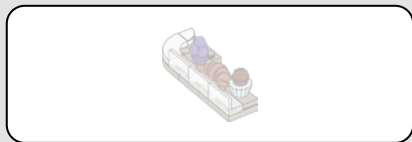

75

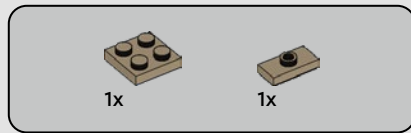
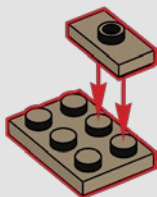

76

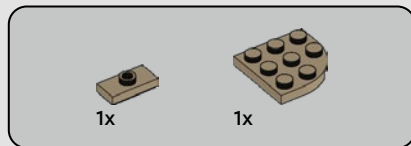
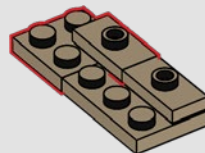

77

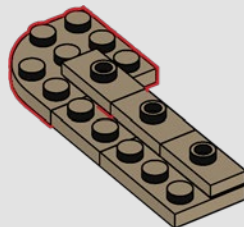

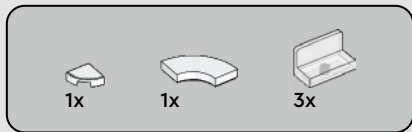

78

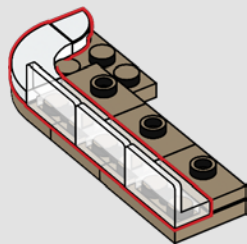

79

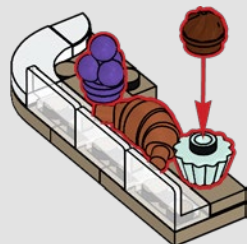

80

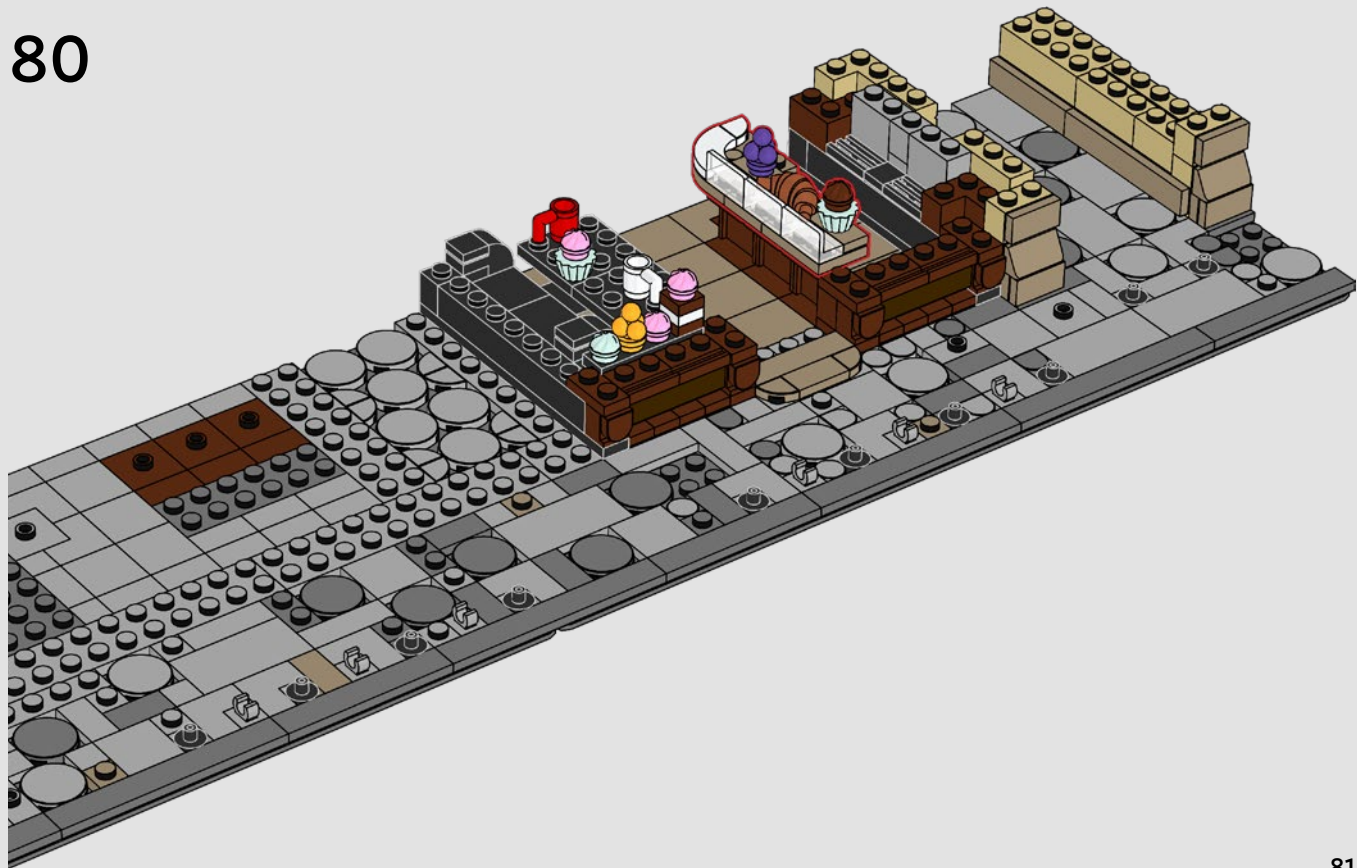



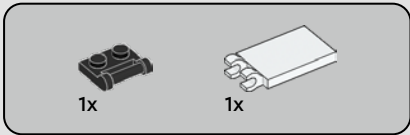

81

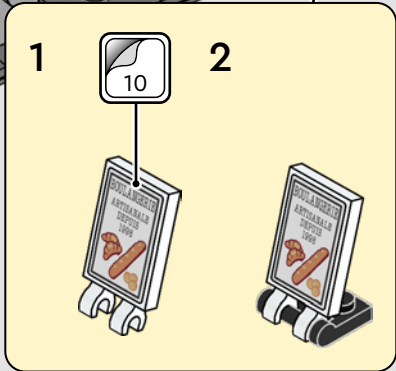
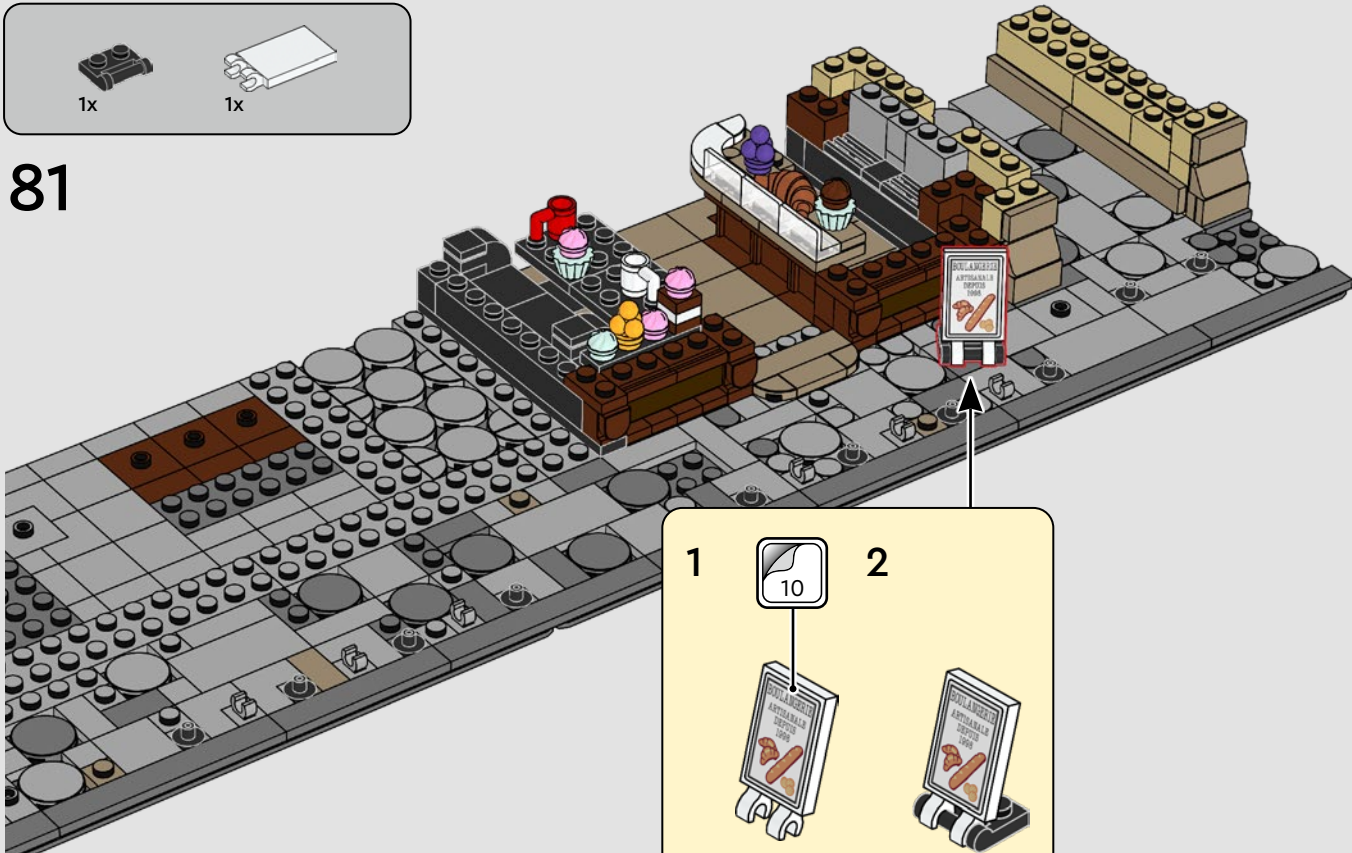

82

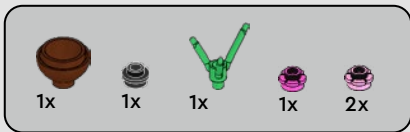

82

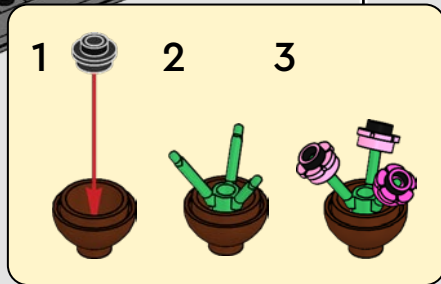
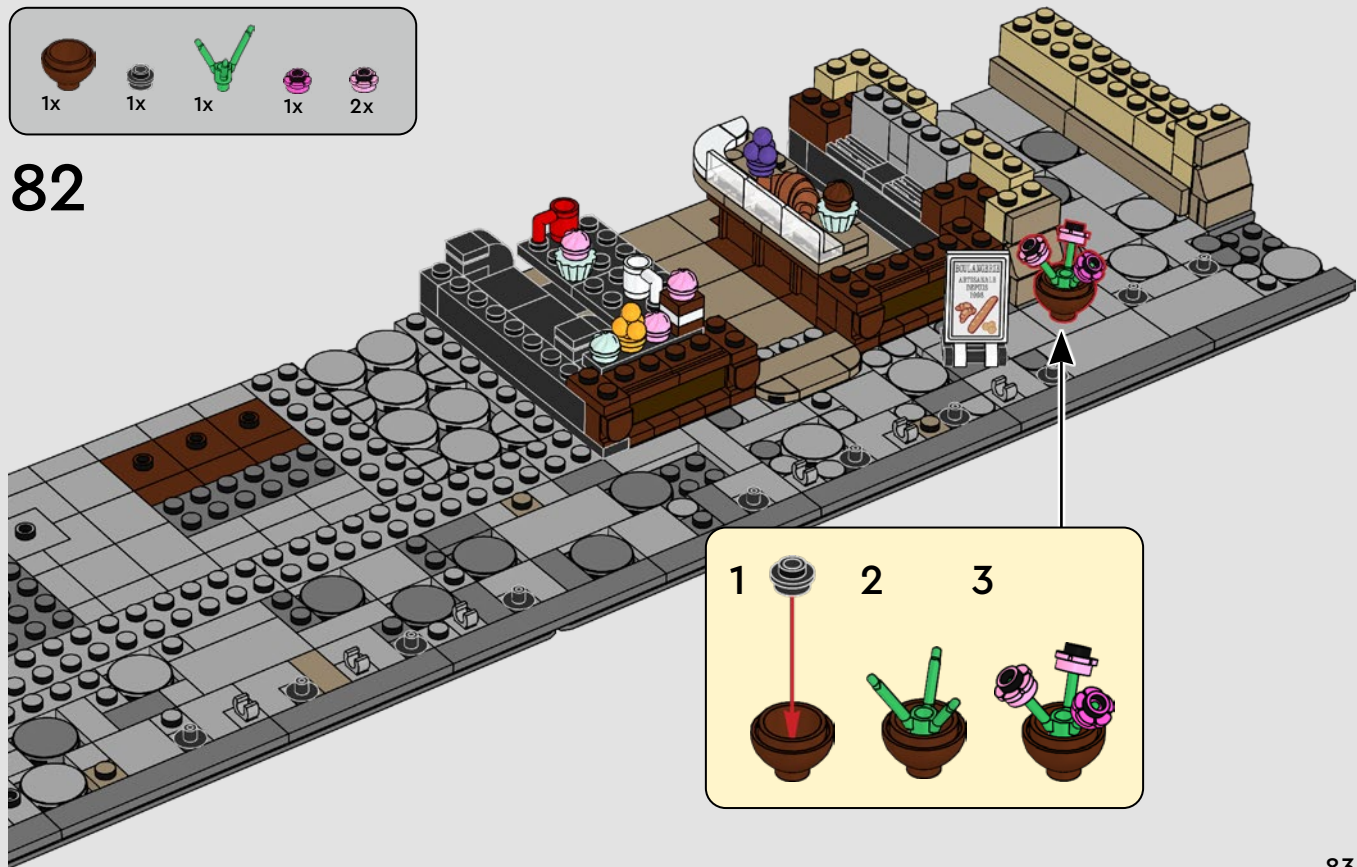



6x



6x

83

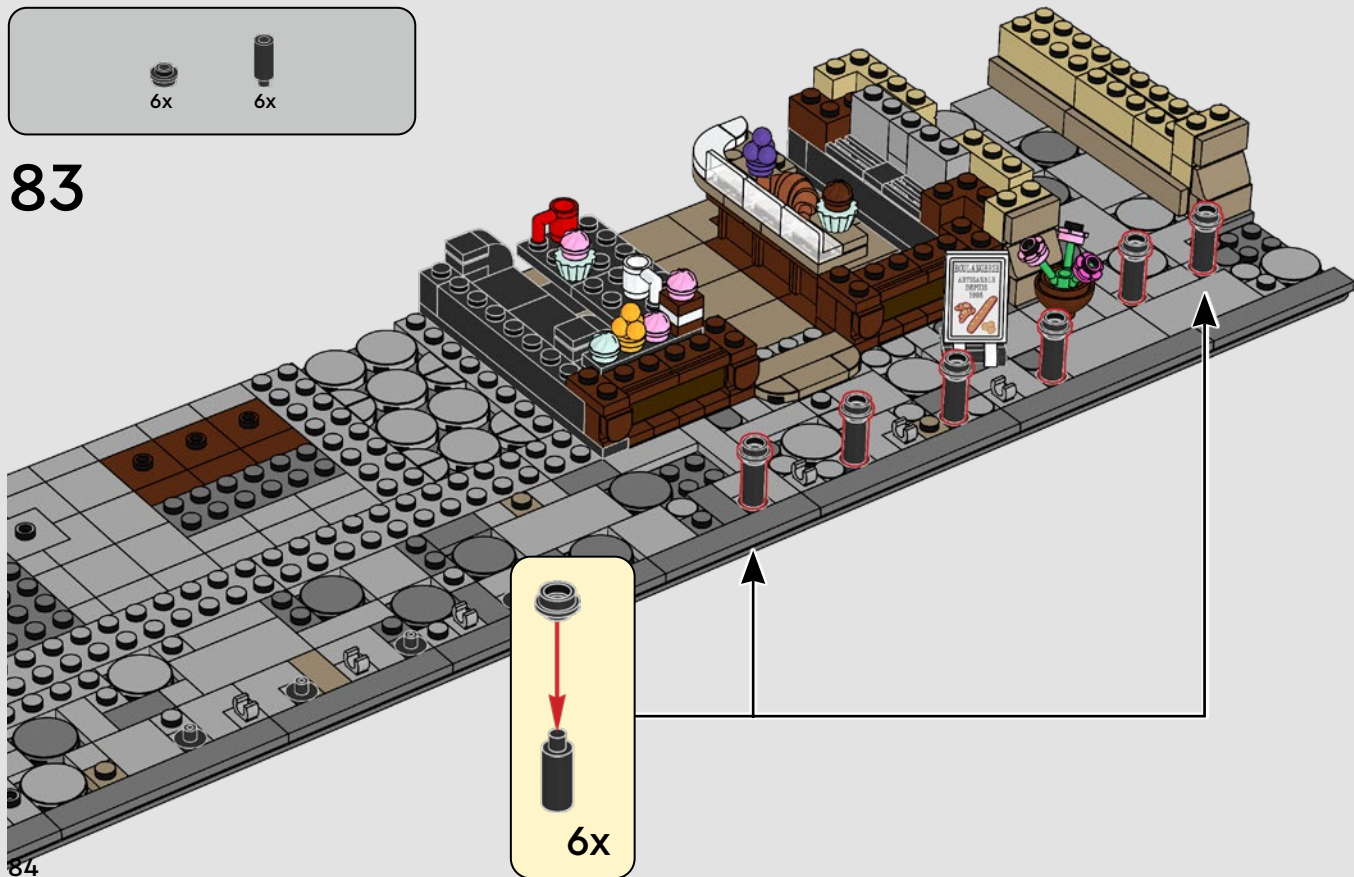

6x

84



3x

84





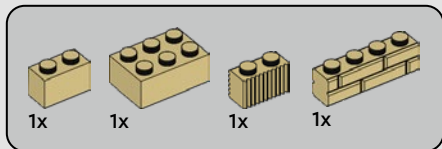

85





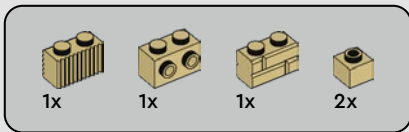

86





1x



2x

87



88

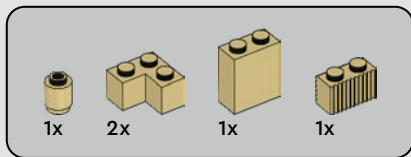

88





1x



2x

89



90

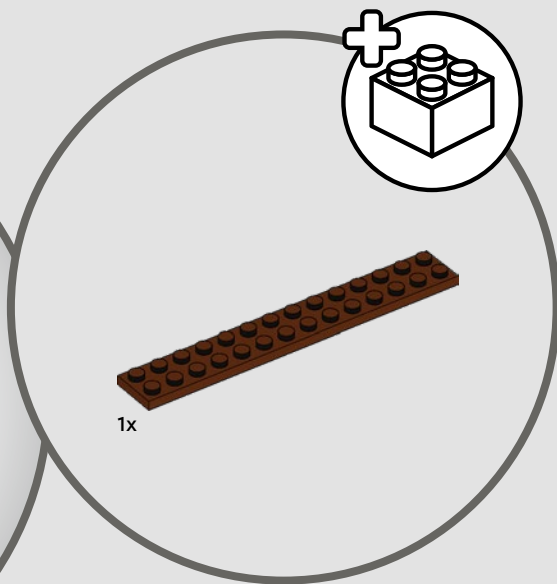
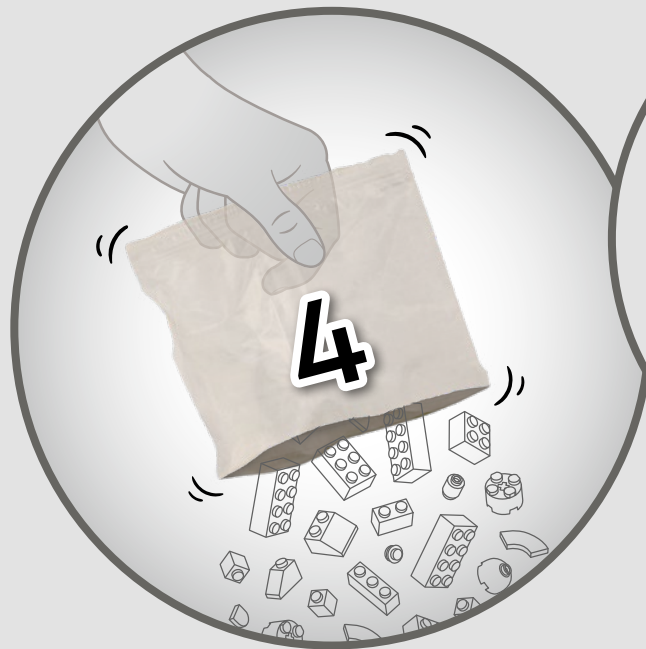



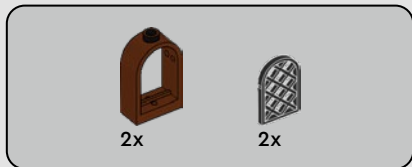

90



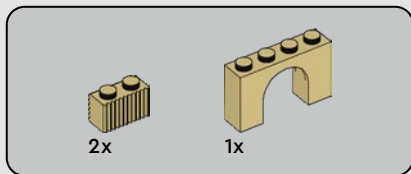

91



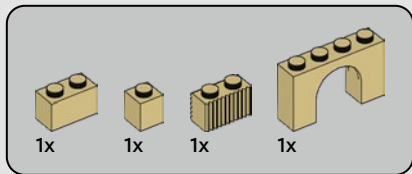

92





2x



2x

# 93

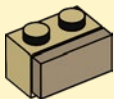

2x





1x



2x

94





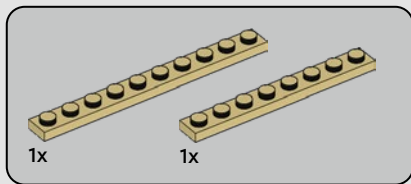

95



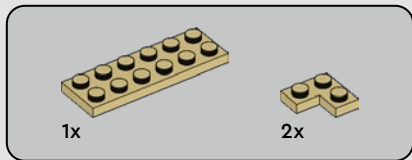

96



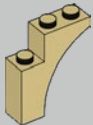

2x

97





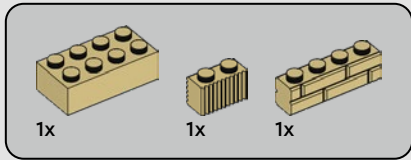

98





1x



1x

99





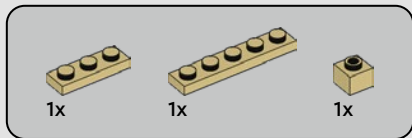

100



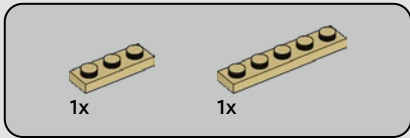

101



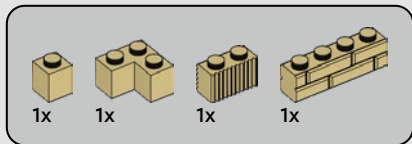

102







1x

103



12



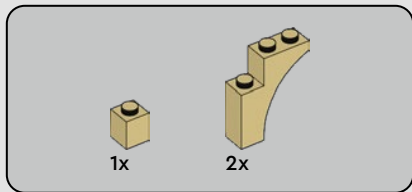

104







1x



2x

# 105



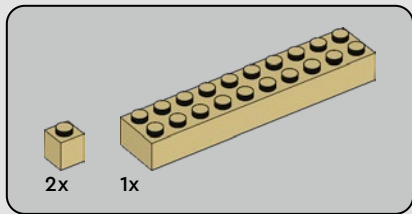

106



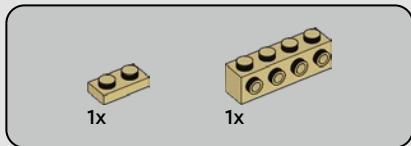

107

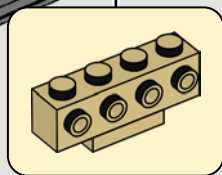



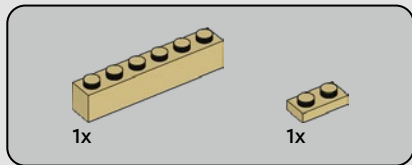

108

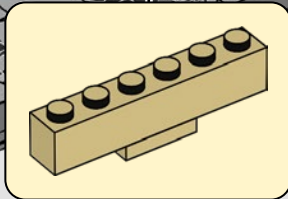

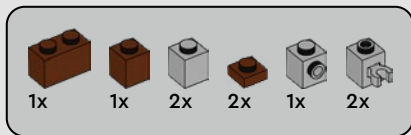

109





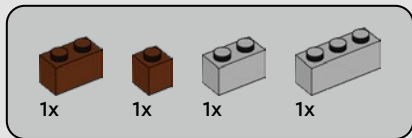

110



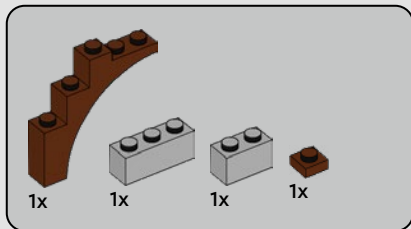

111





112







2x

113



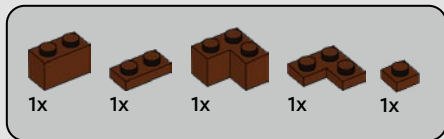

114







8x

# 115

1



2



2x



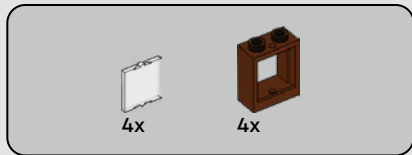

116

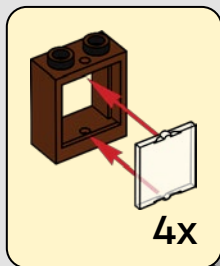



117





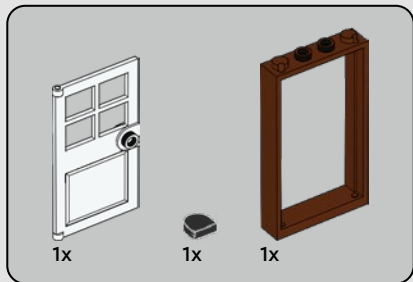

118



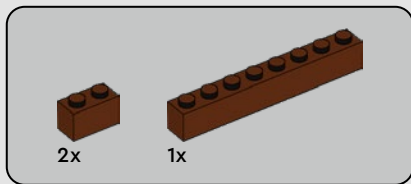

119







2x

120



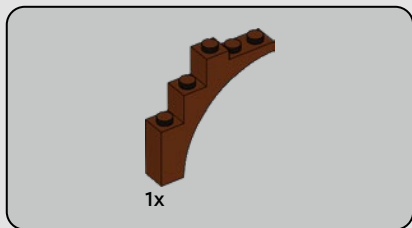

121



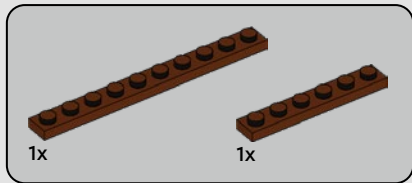

122

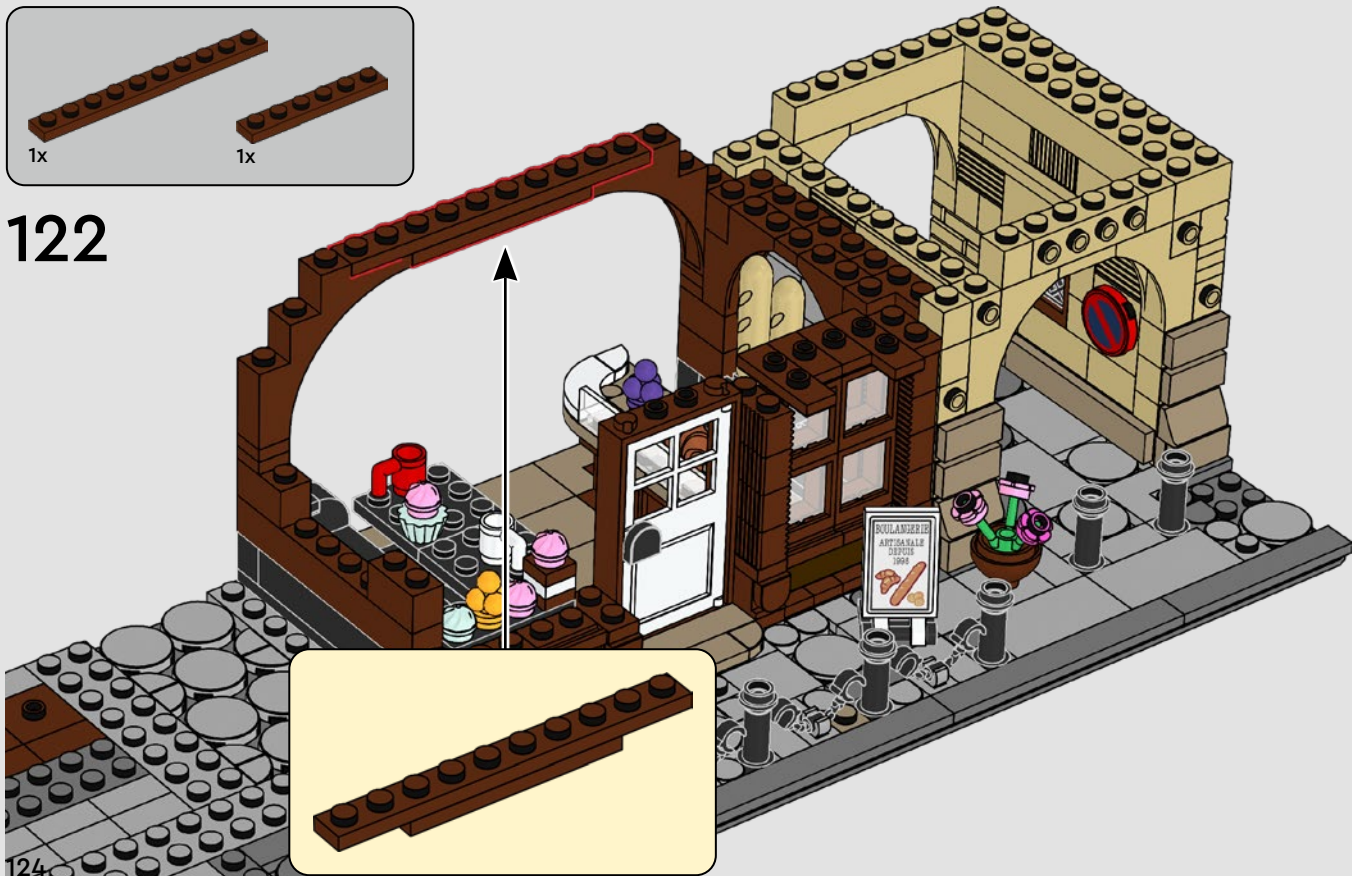



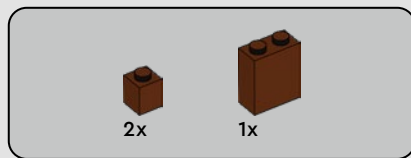

123



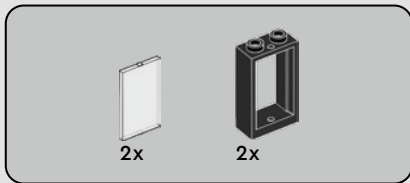

124

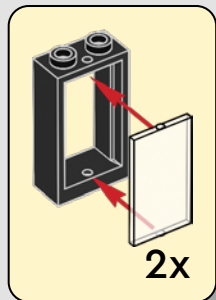



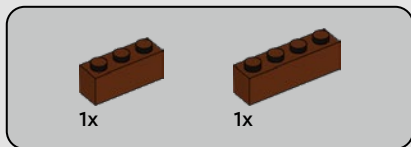

125



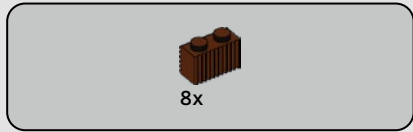

126

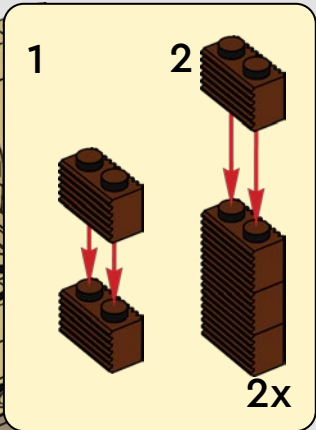

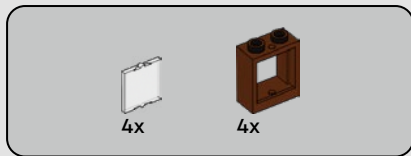

127







1x



2x



2x

# 128





129





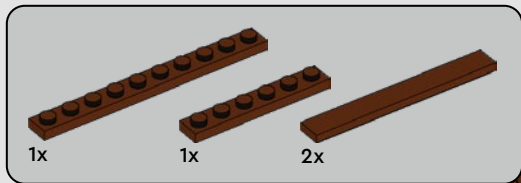

130



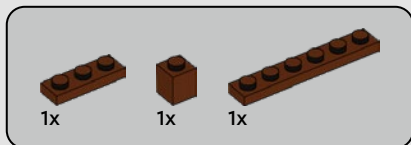

131



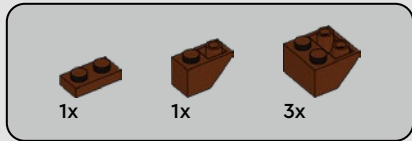

132







133



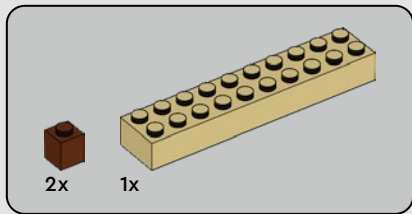

134





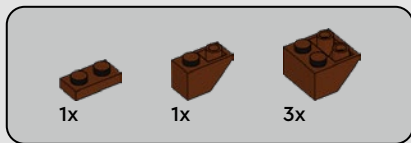

135



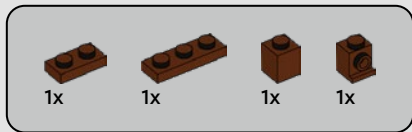

136



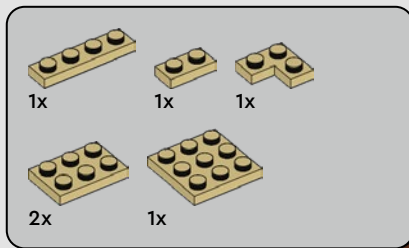

137





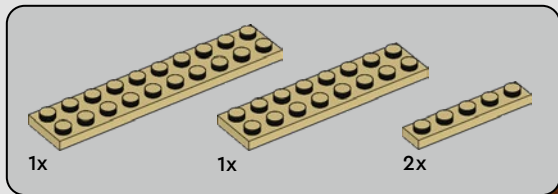

138







4x

139



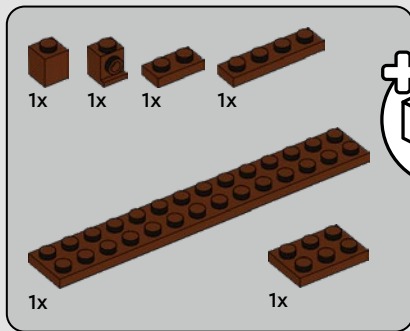

140

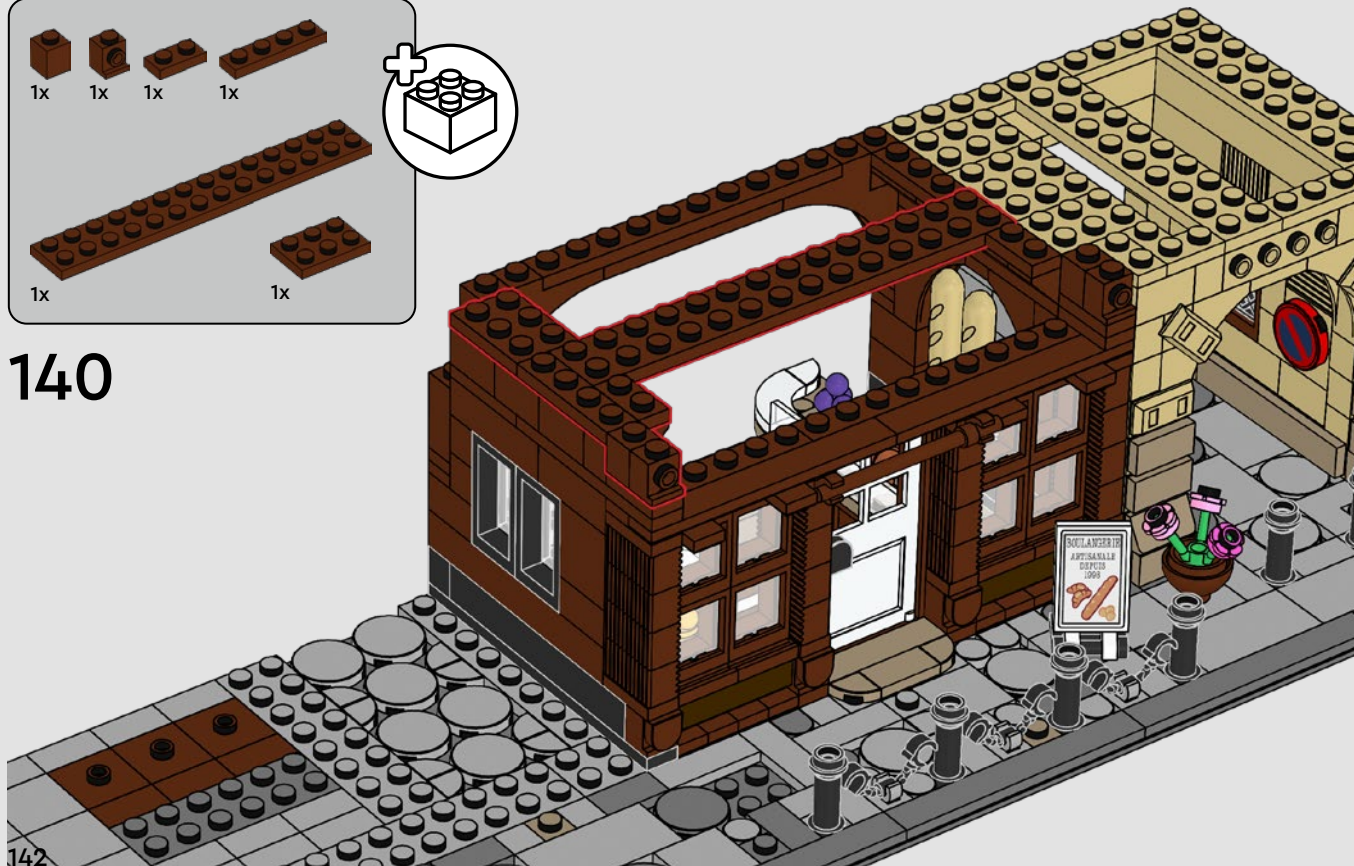

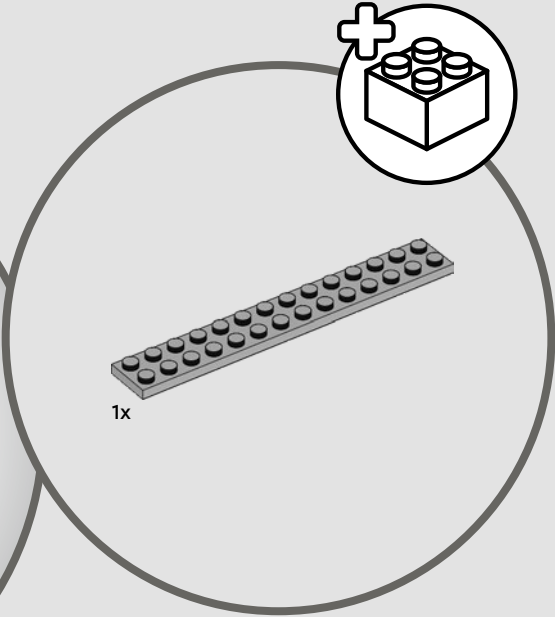

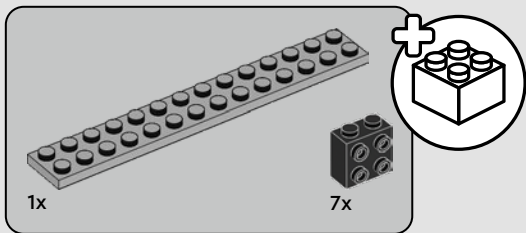

141

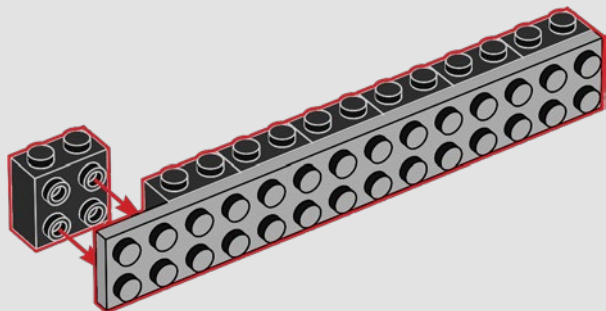

144

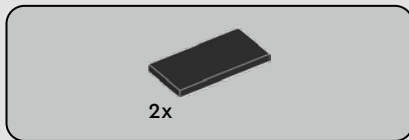

142

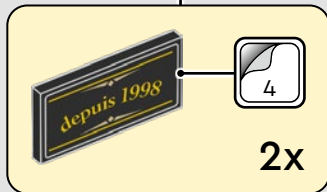
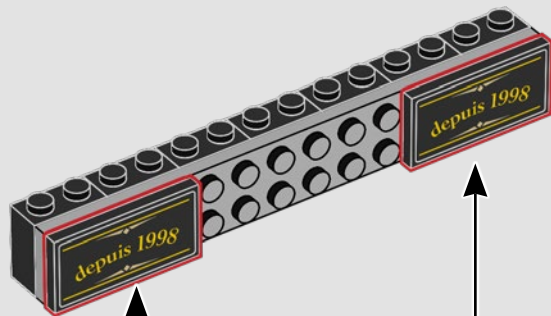



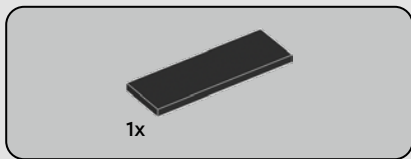

143

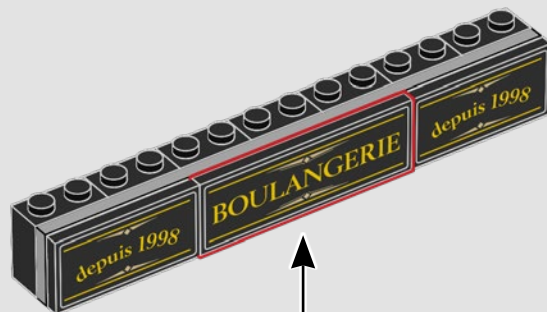

144



146

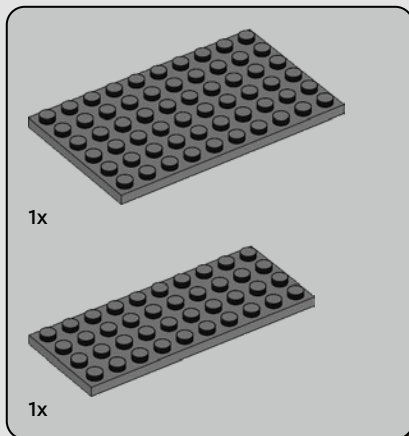

145

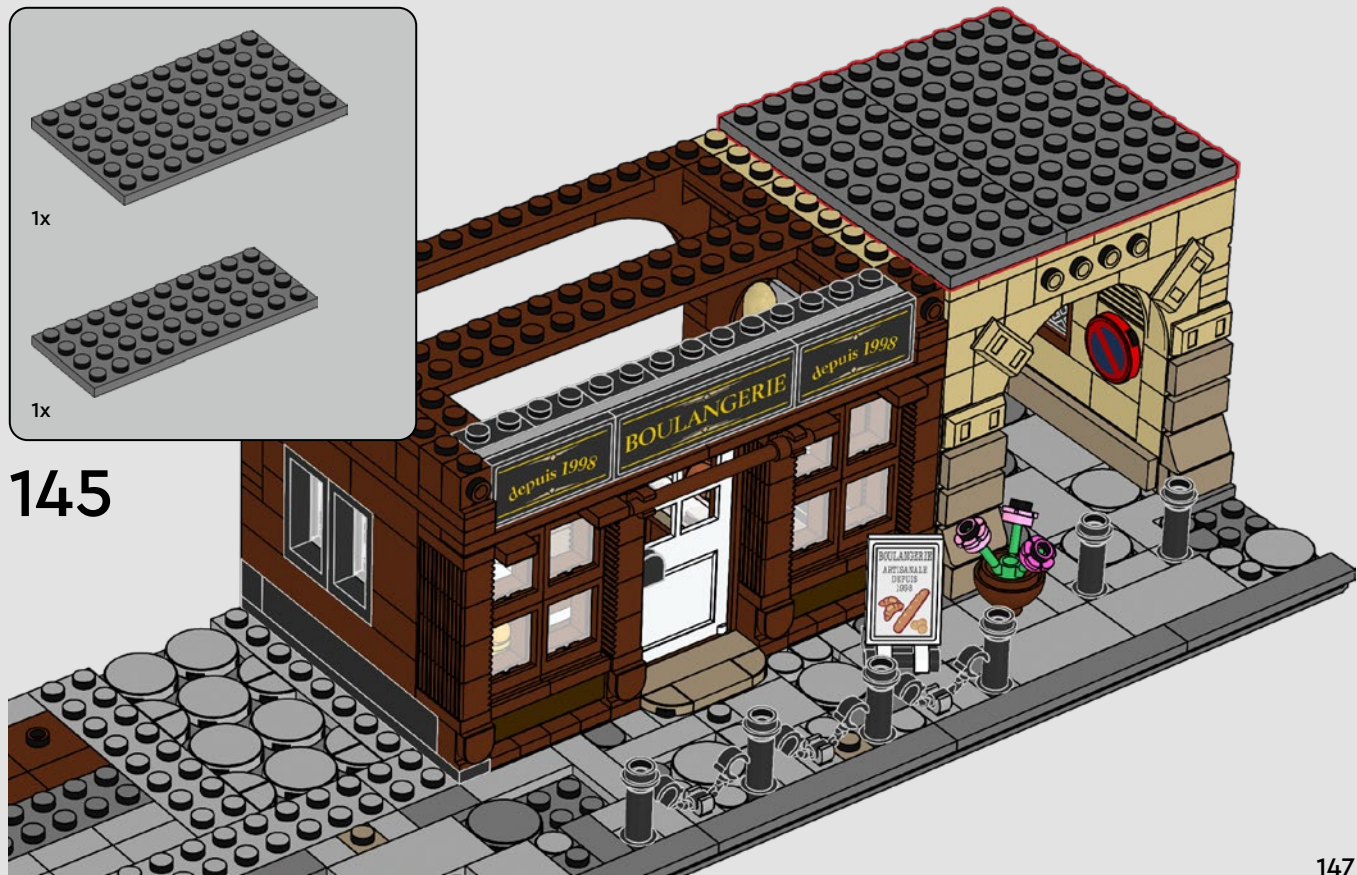



1x



2x

146





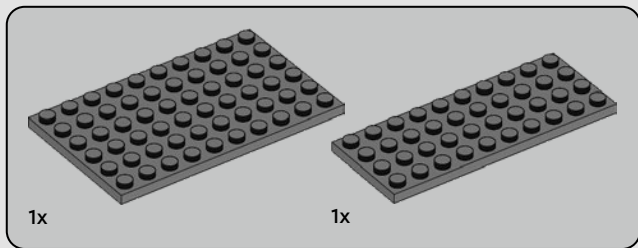

147

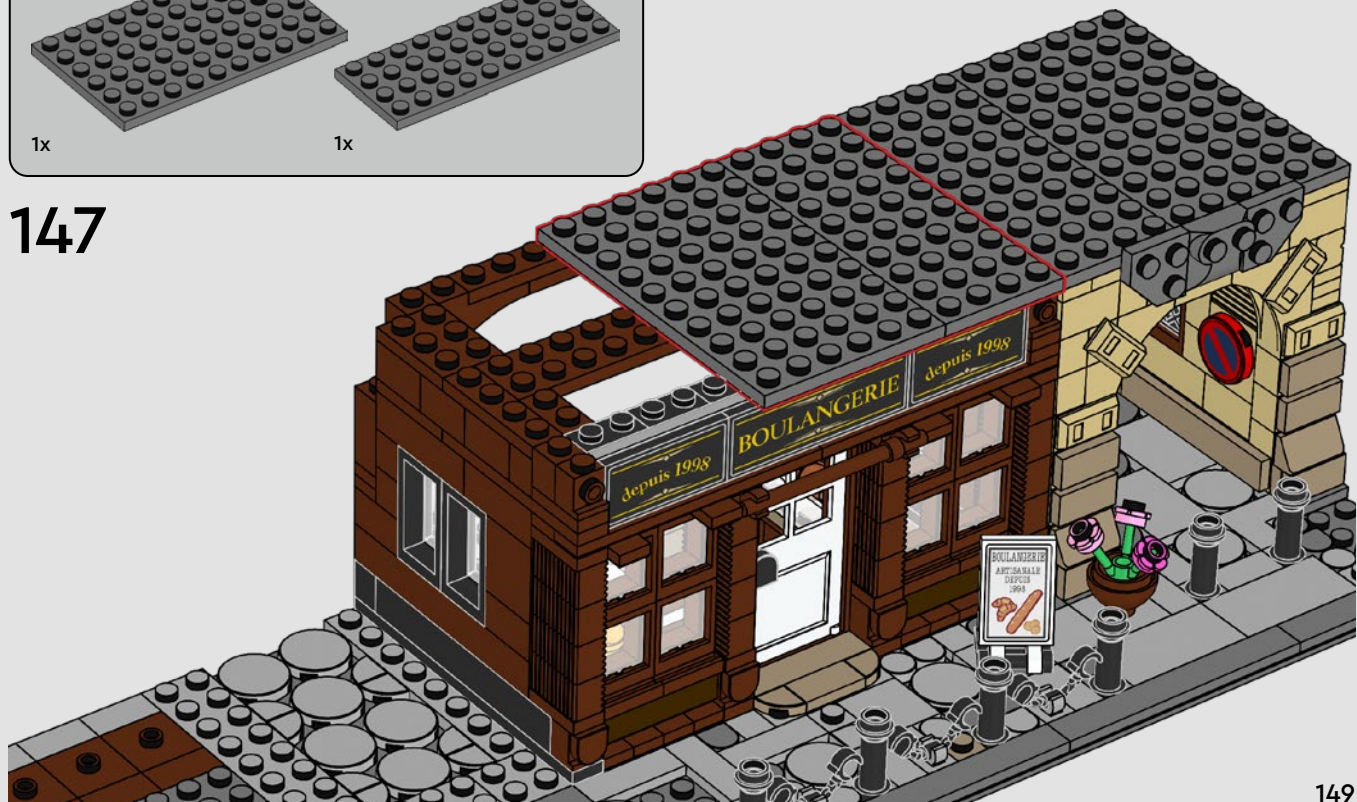

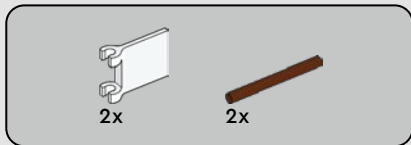

148

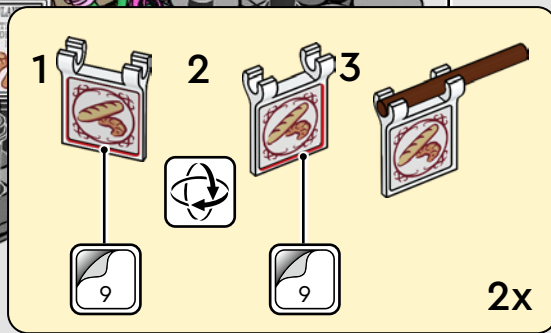
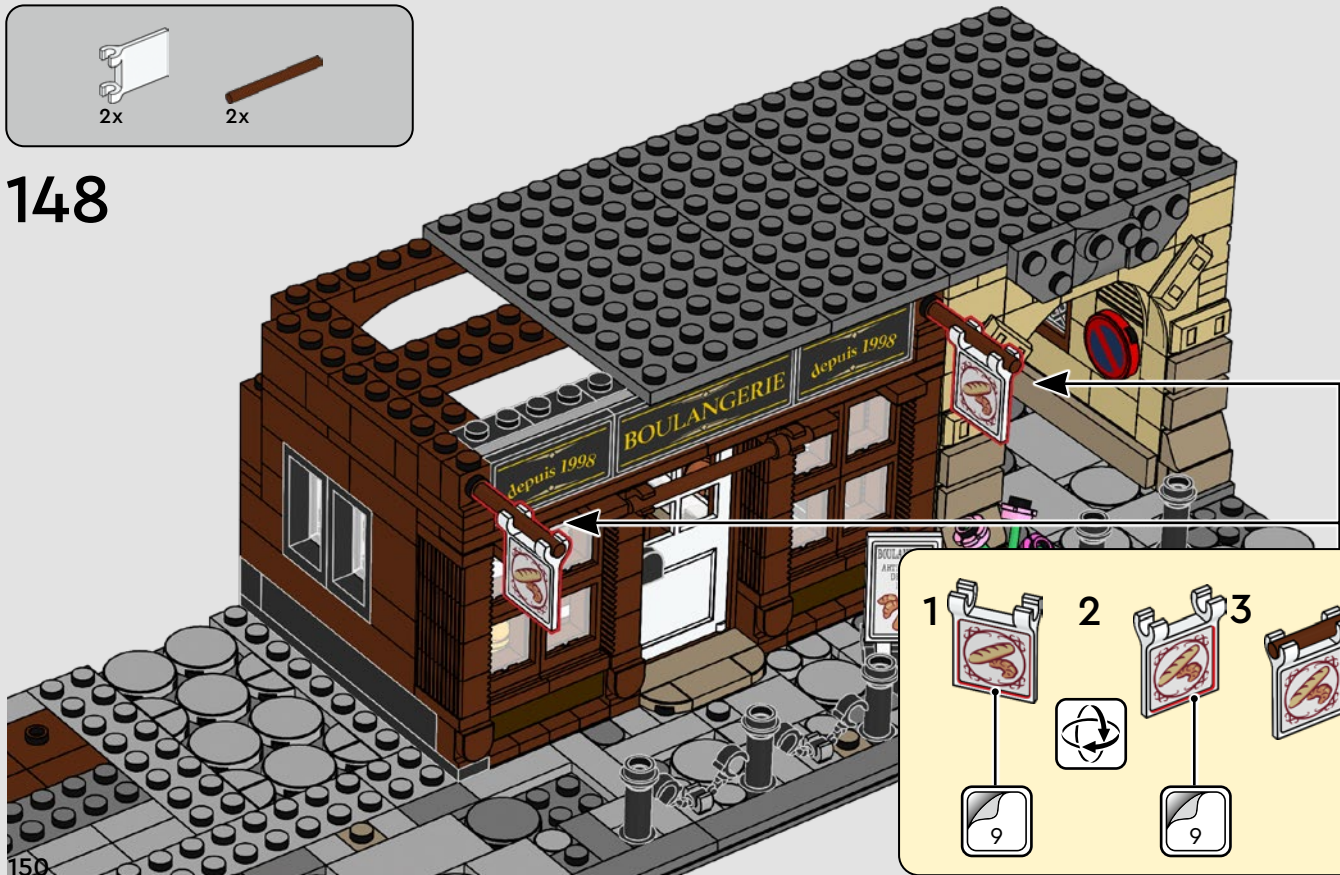

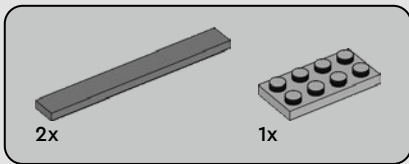

149

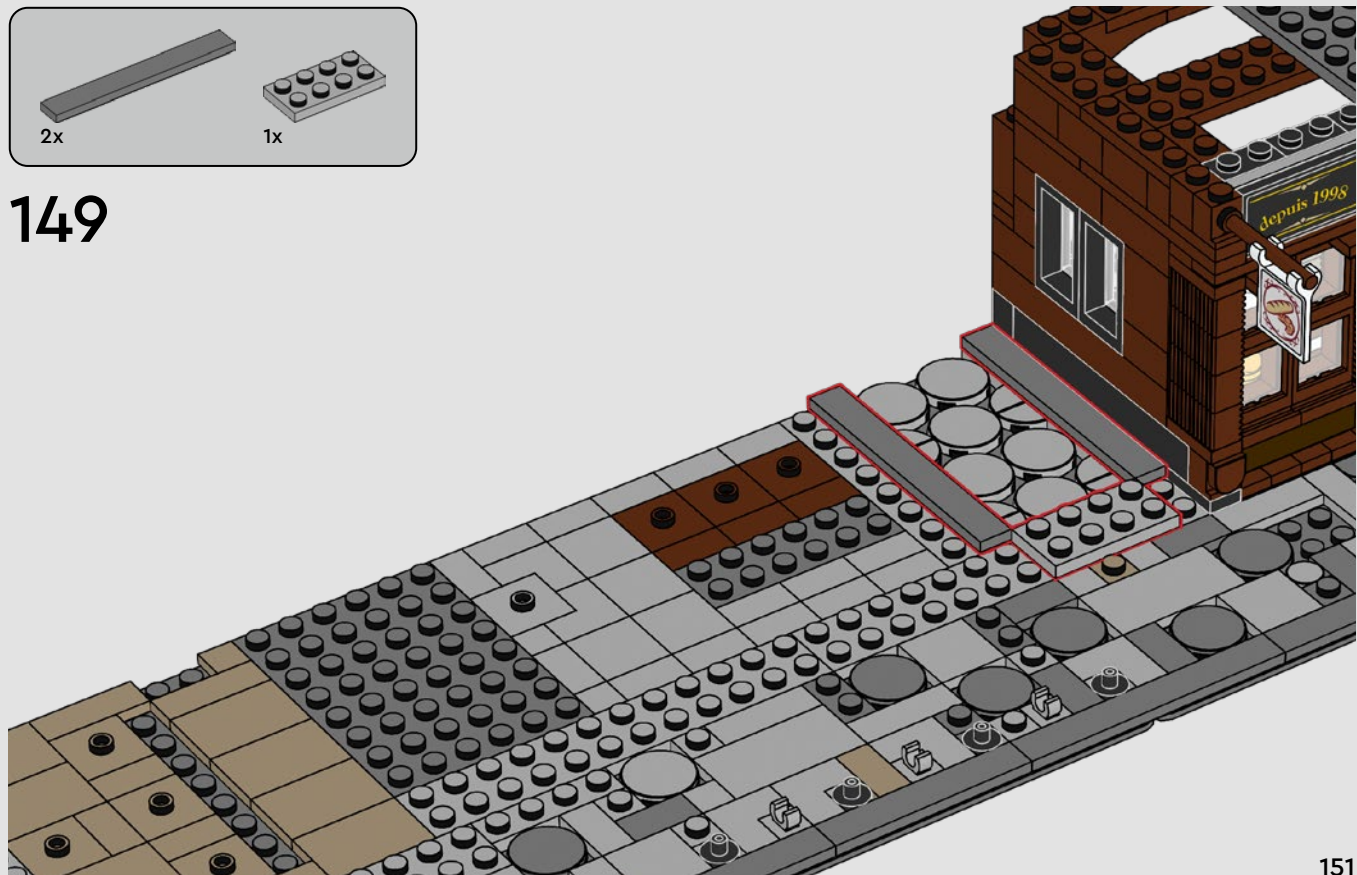



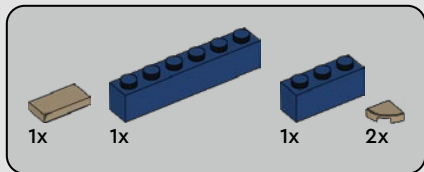

150

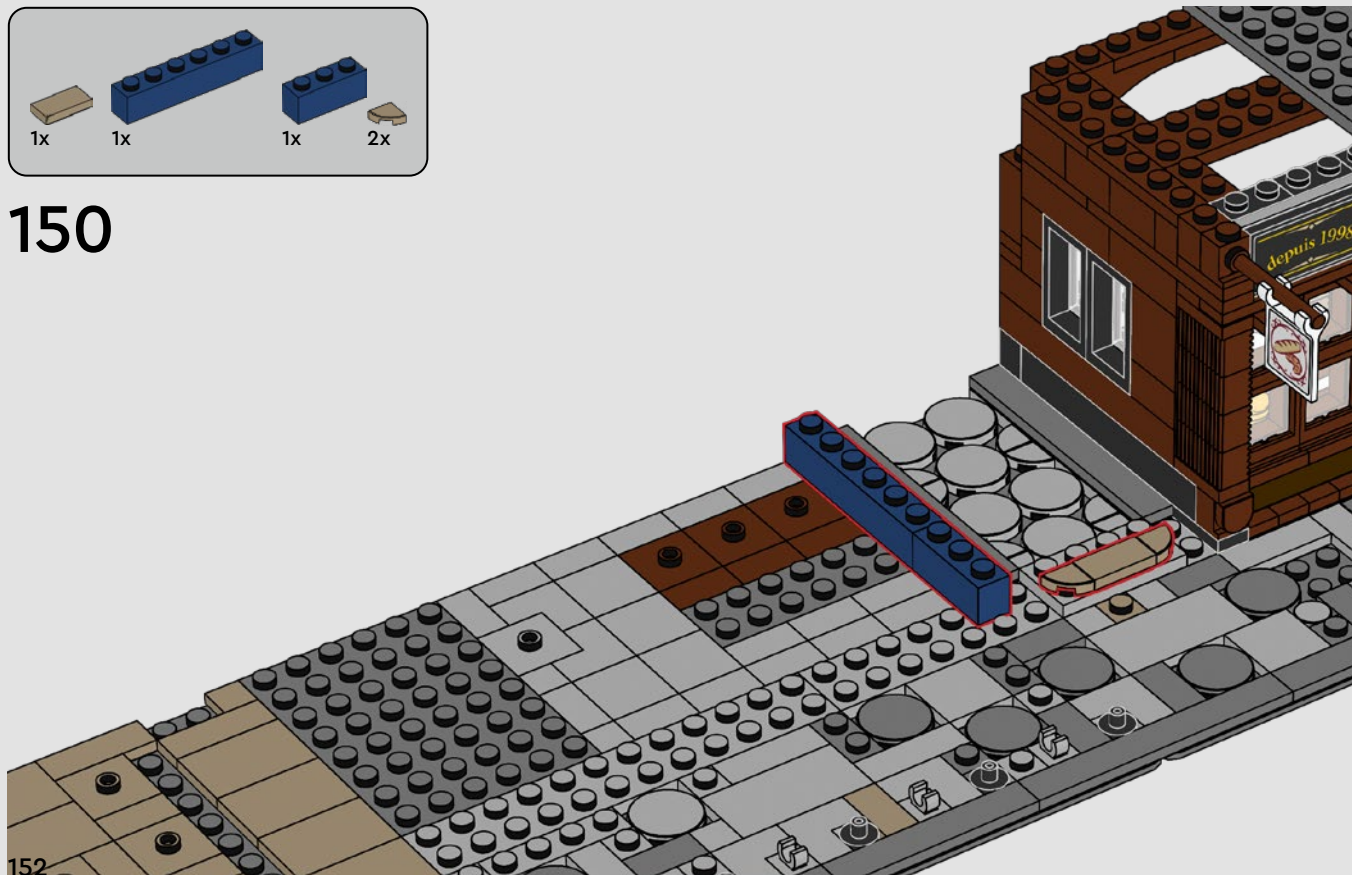





2x



2x

# 151

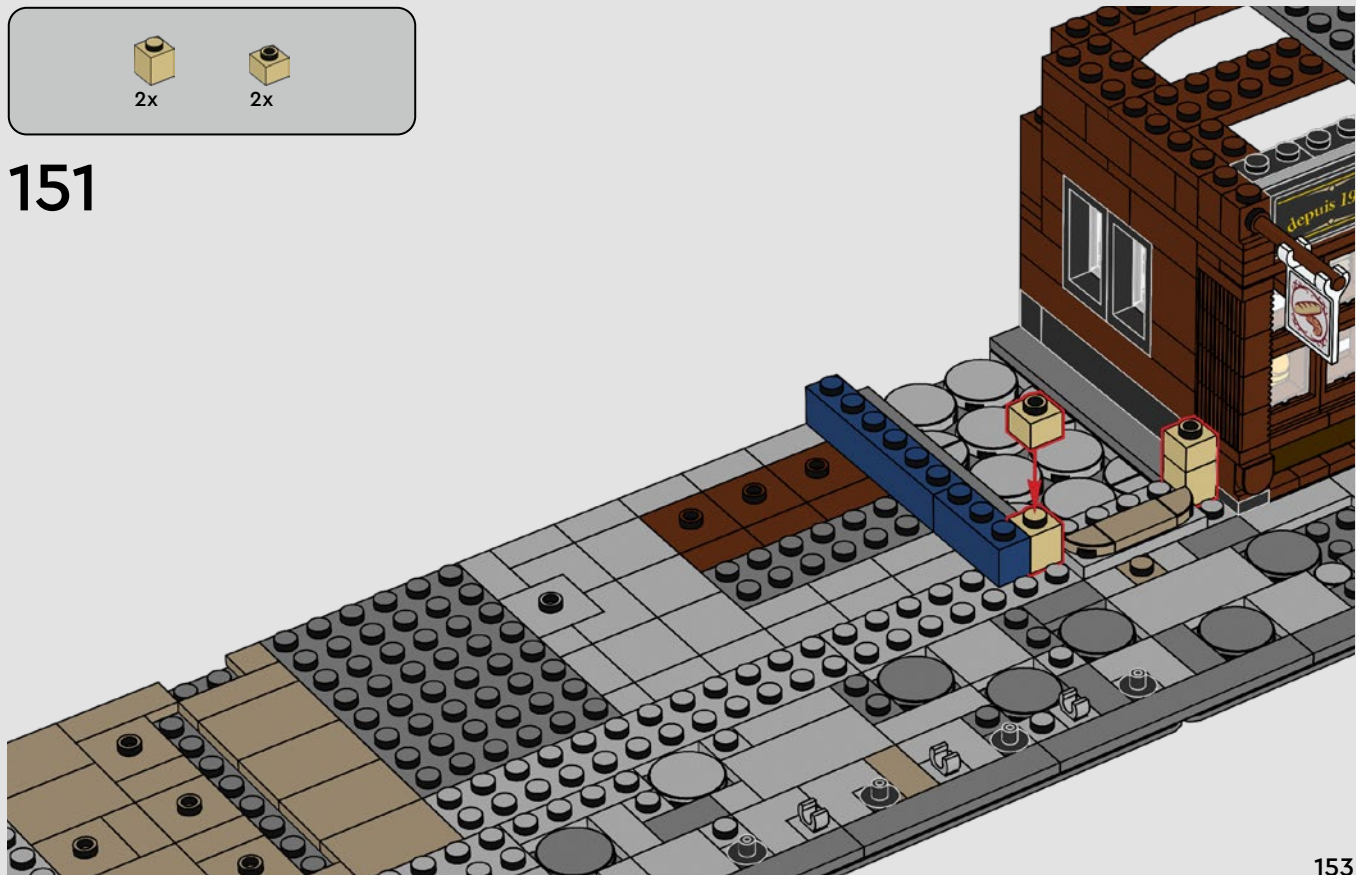

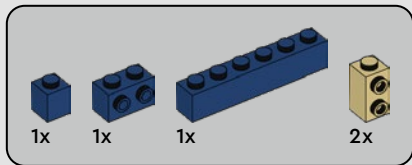

152

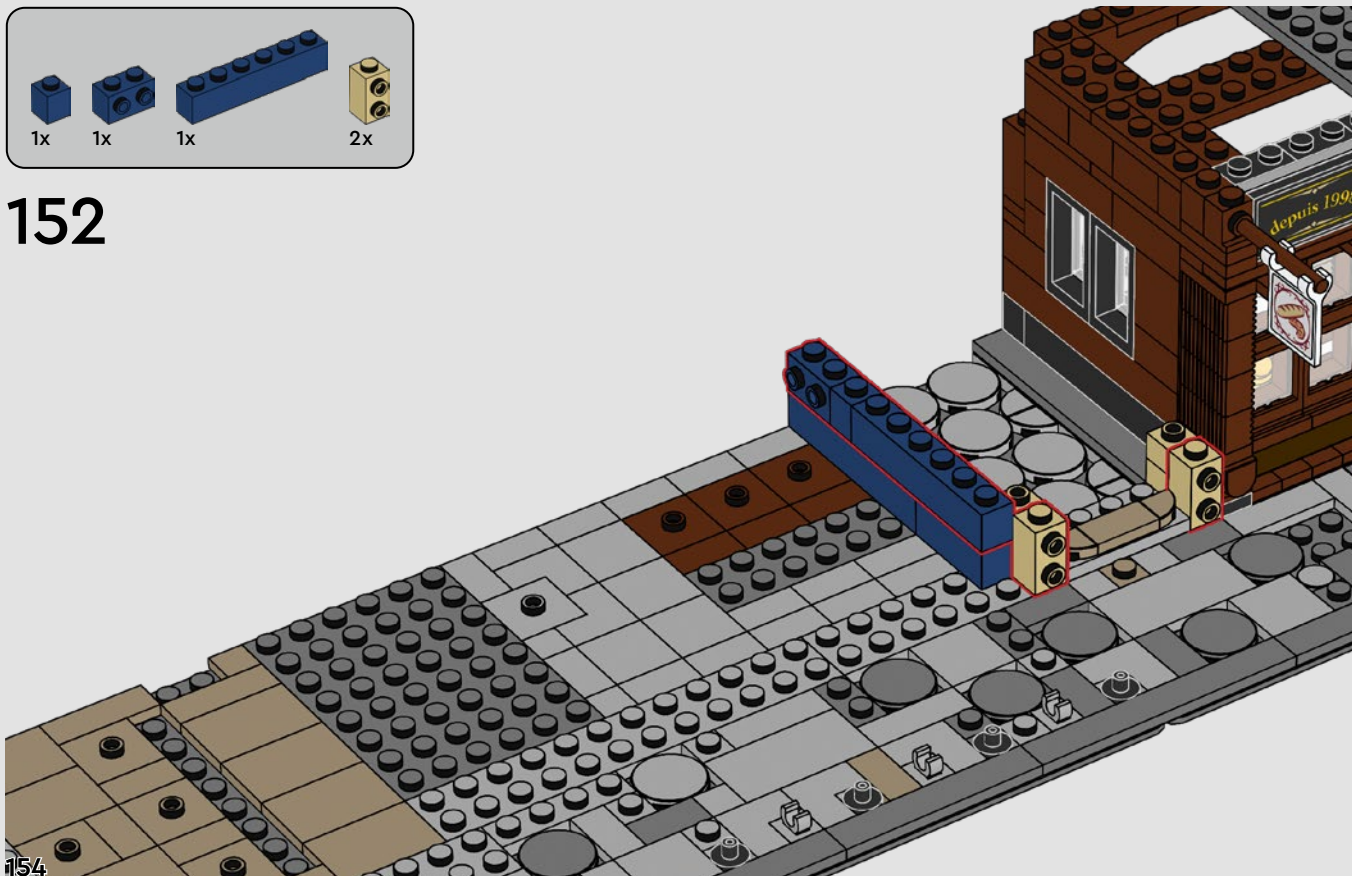

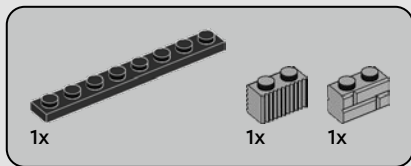

153

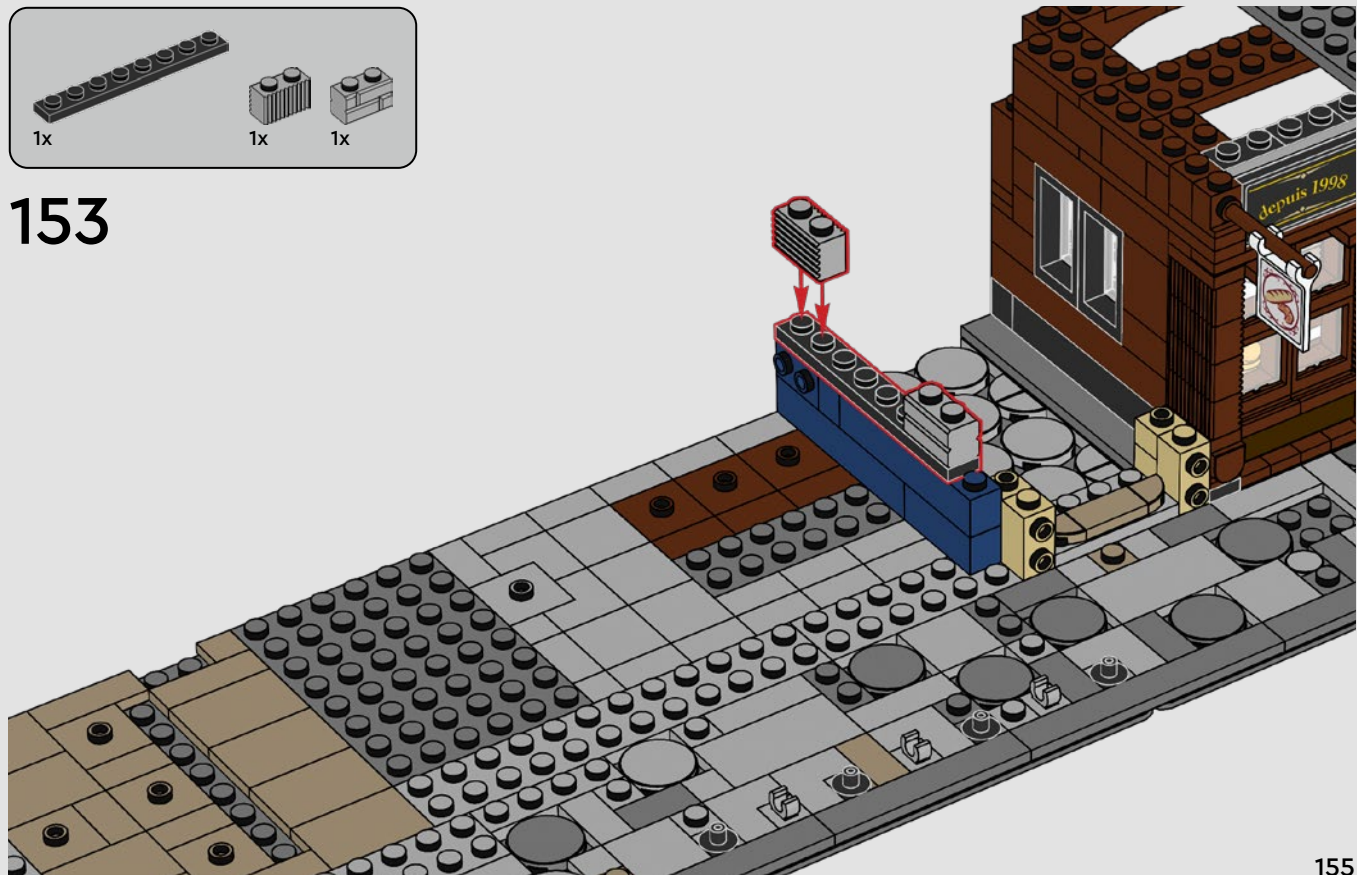

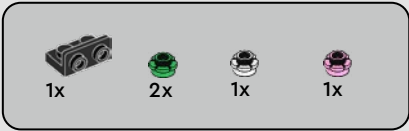

154

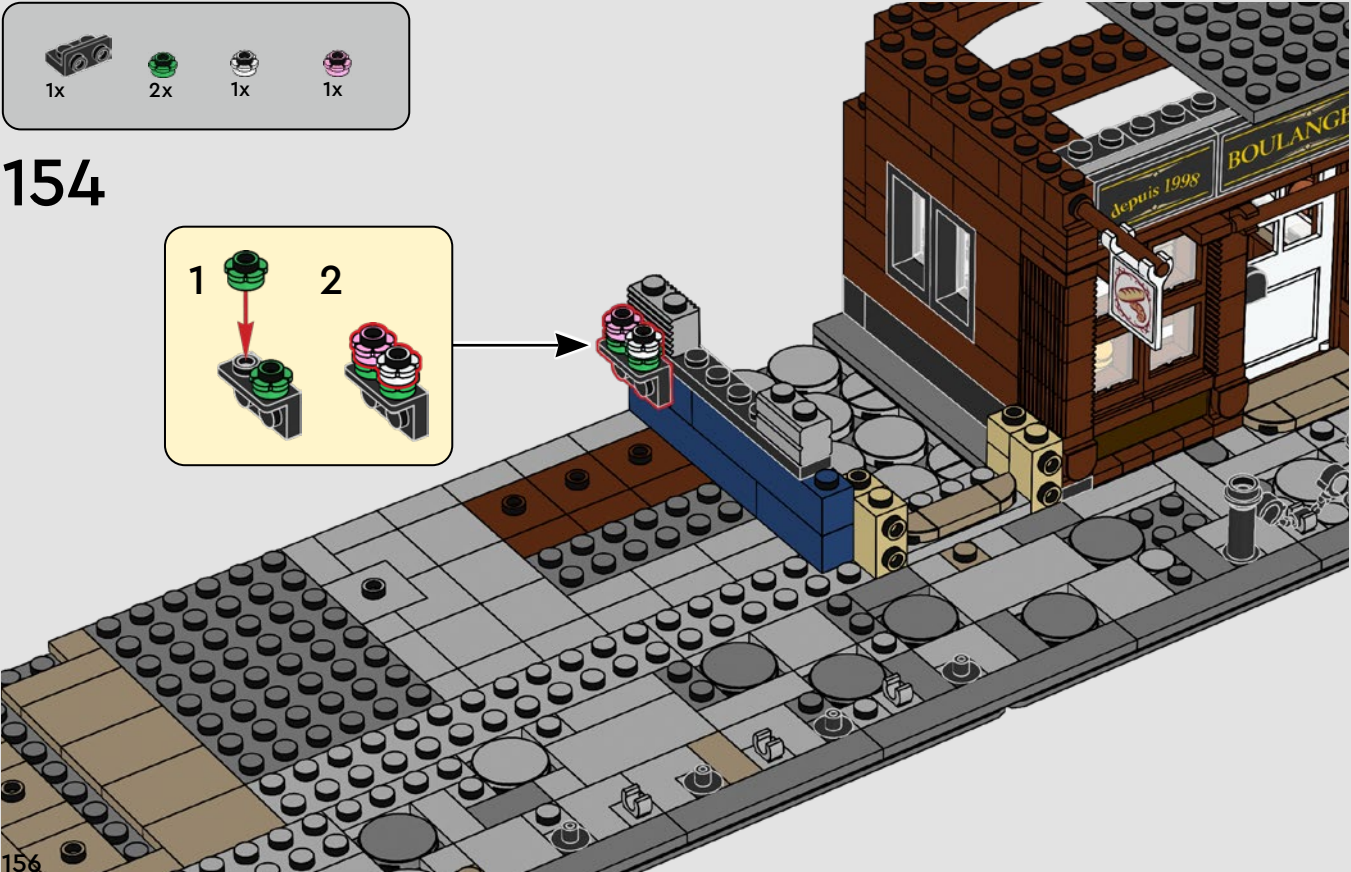
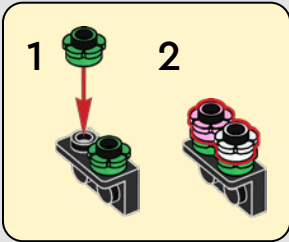





1x



1x

# 155

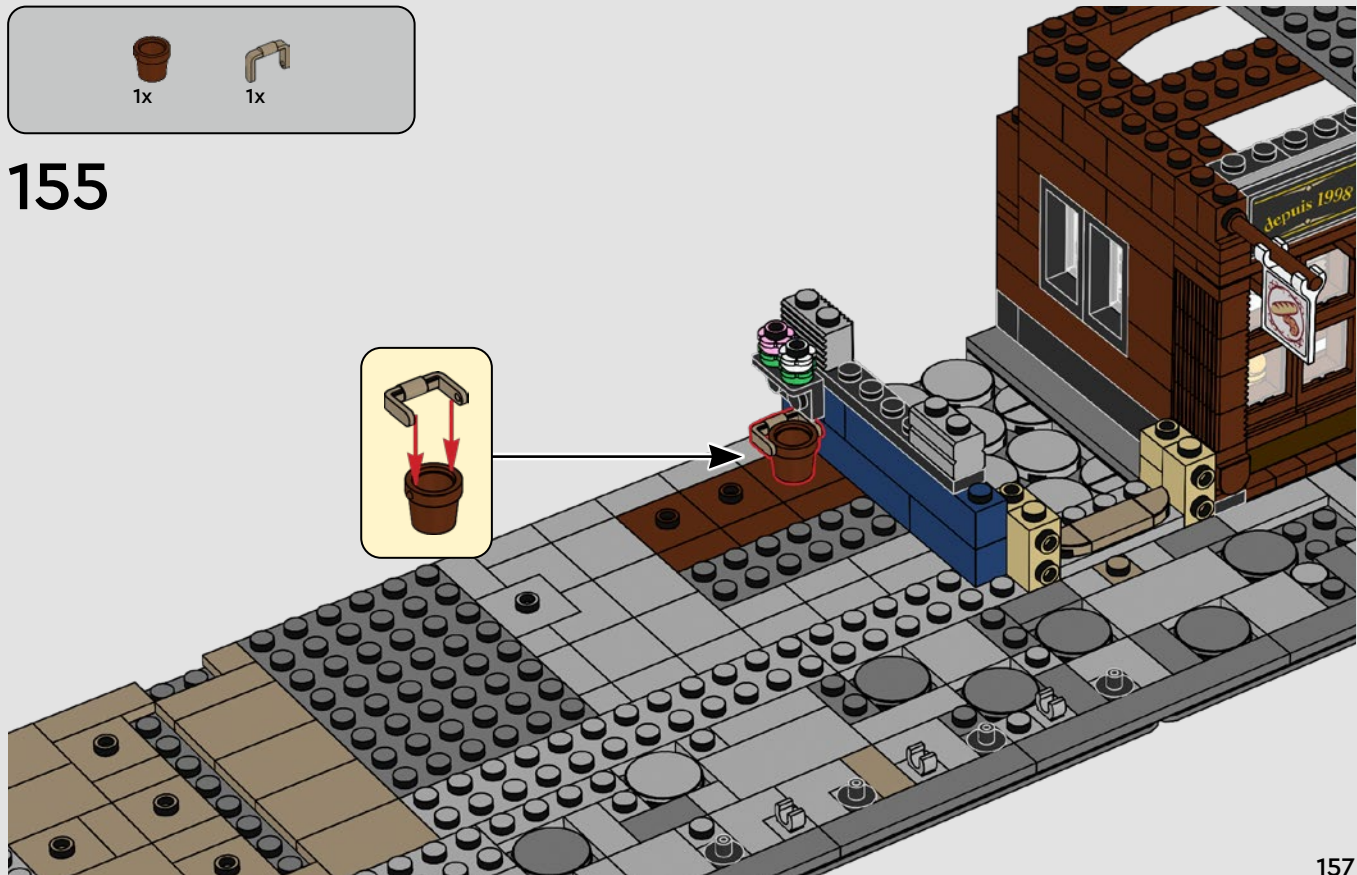

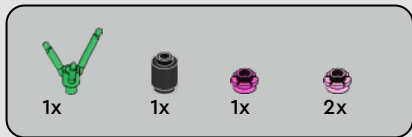

156

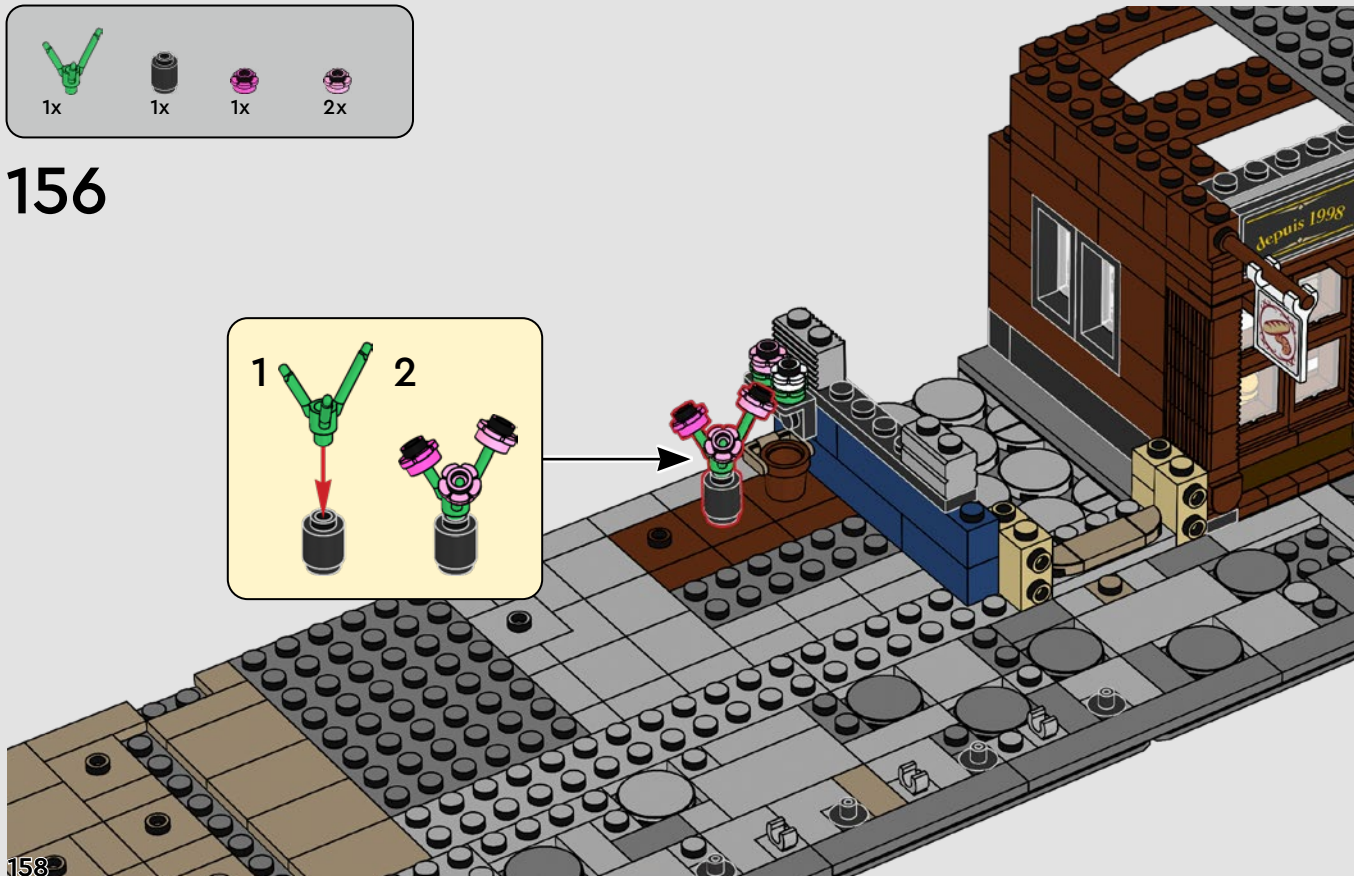
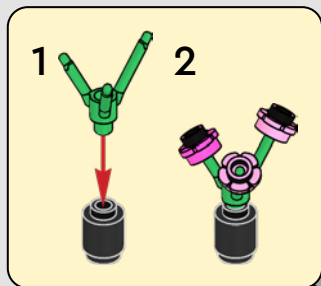

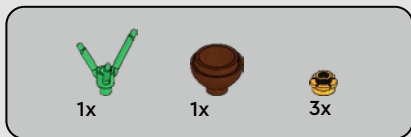

157

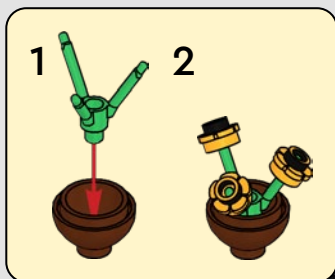

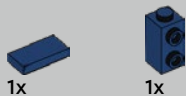

1x

1x

158

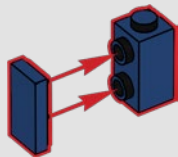

1x

159

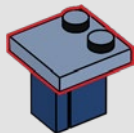

2x



1x

160

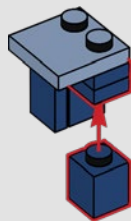

1x

161

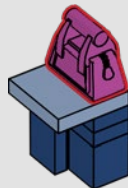



162

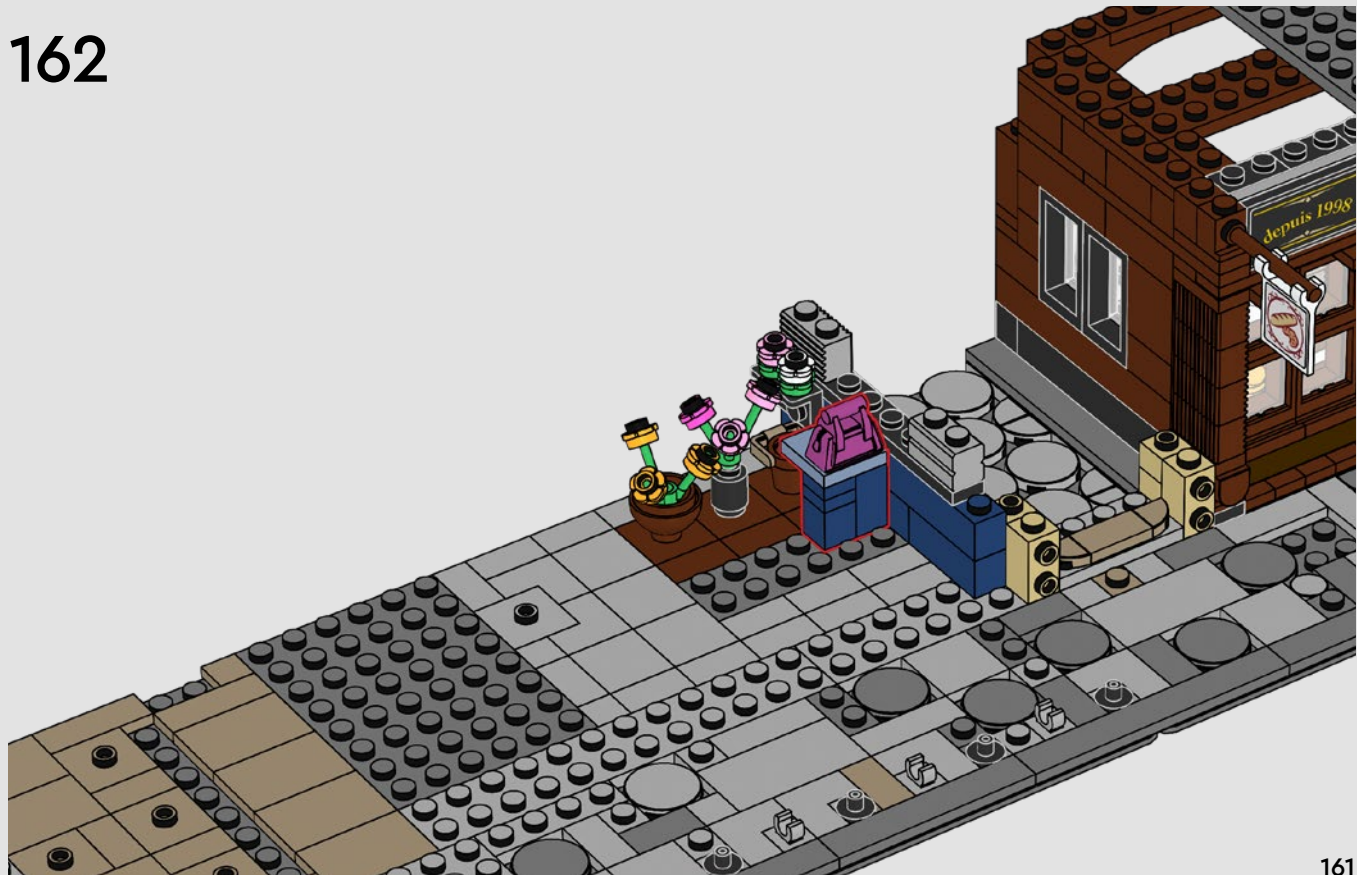

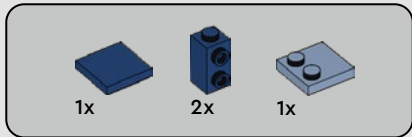

163

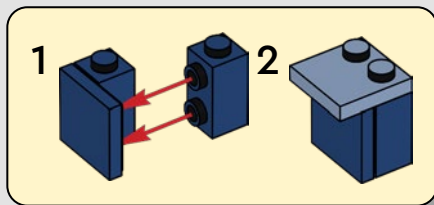



2x



1x

164



1x

165

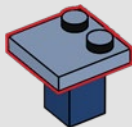

1x

166

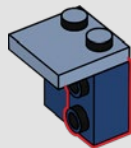

1x

167

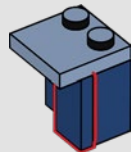



1x



1x

# 168



1x



1x

# 169

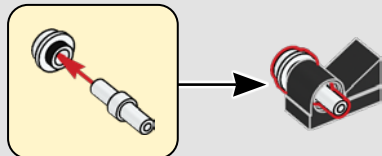

164



1x

# 170



# 171

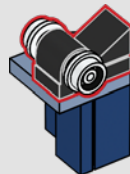



172

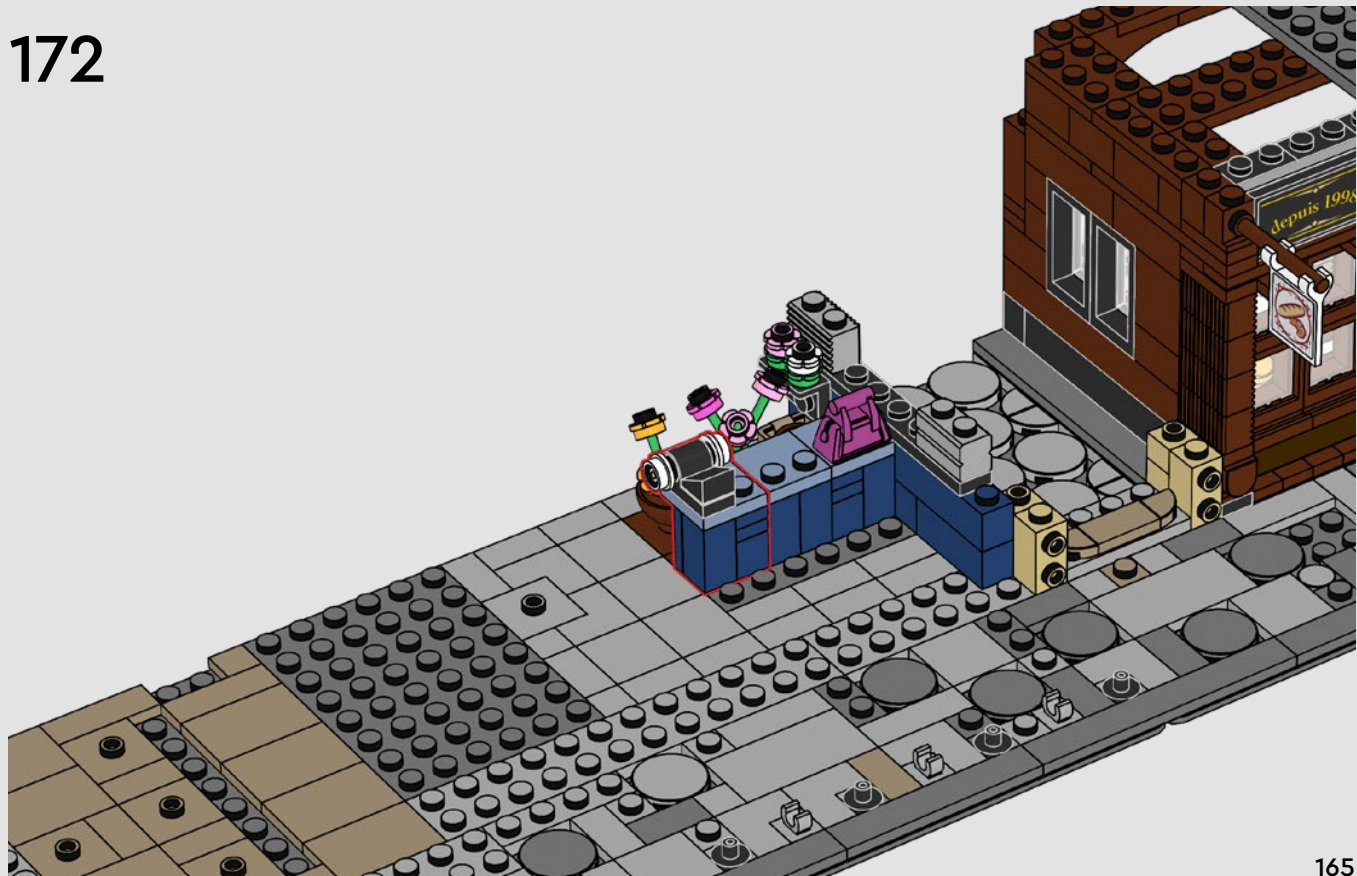



173



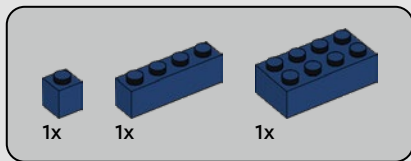

174

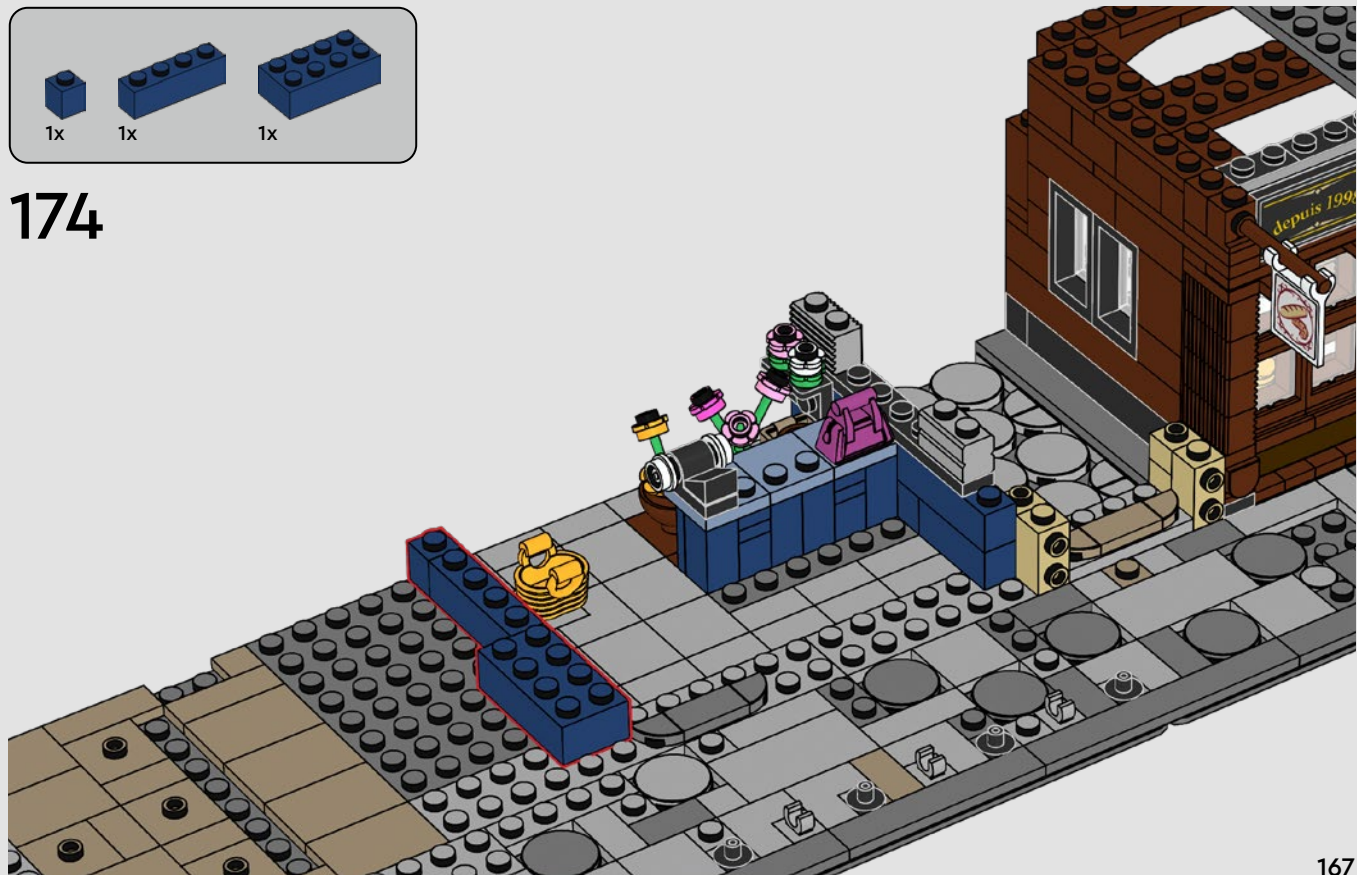



175

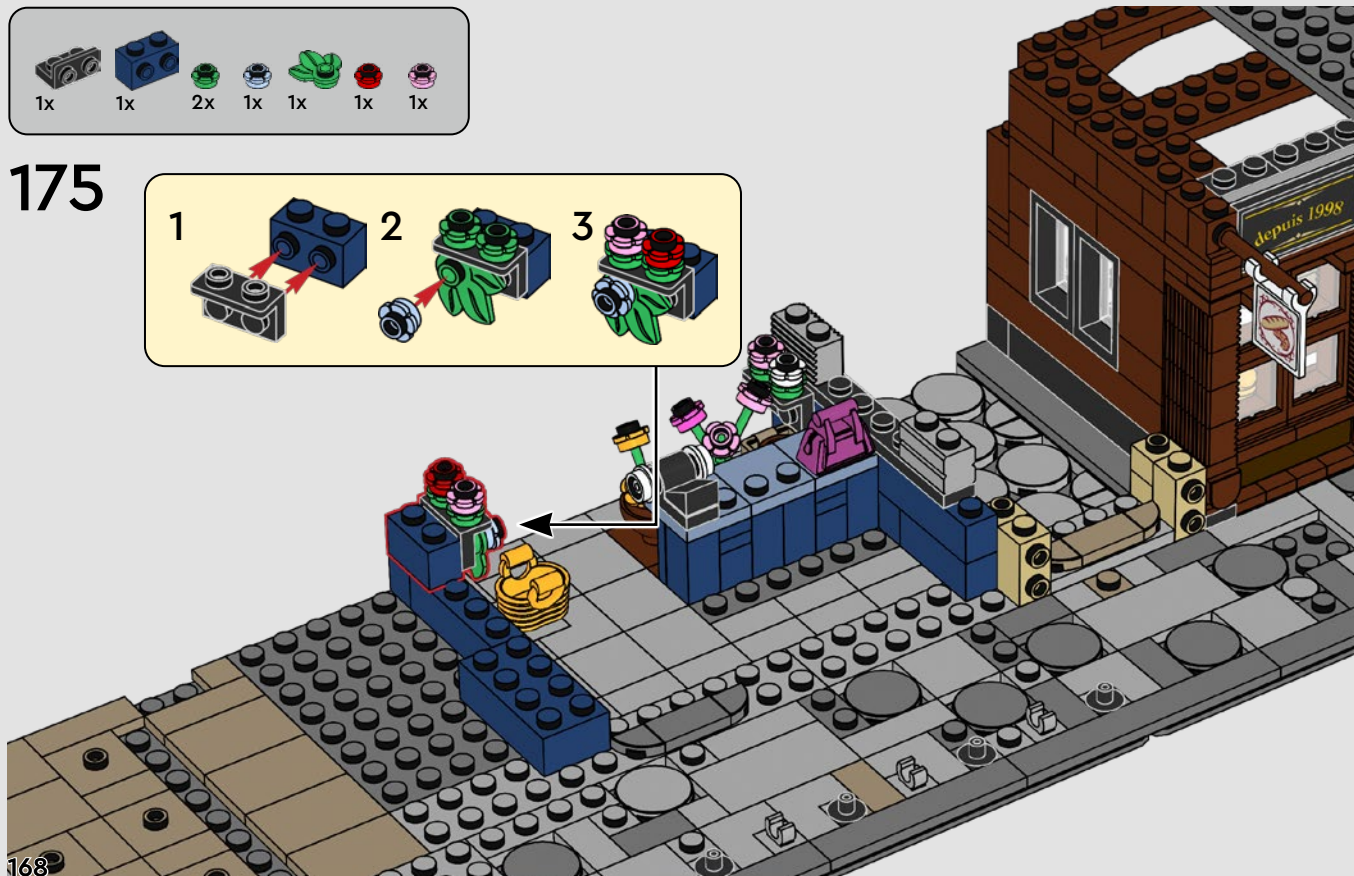
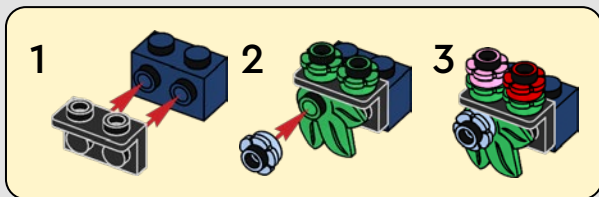



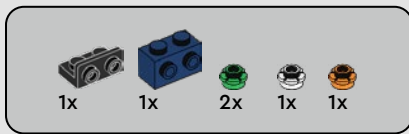

176

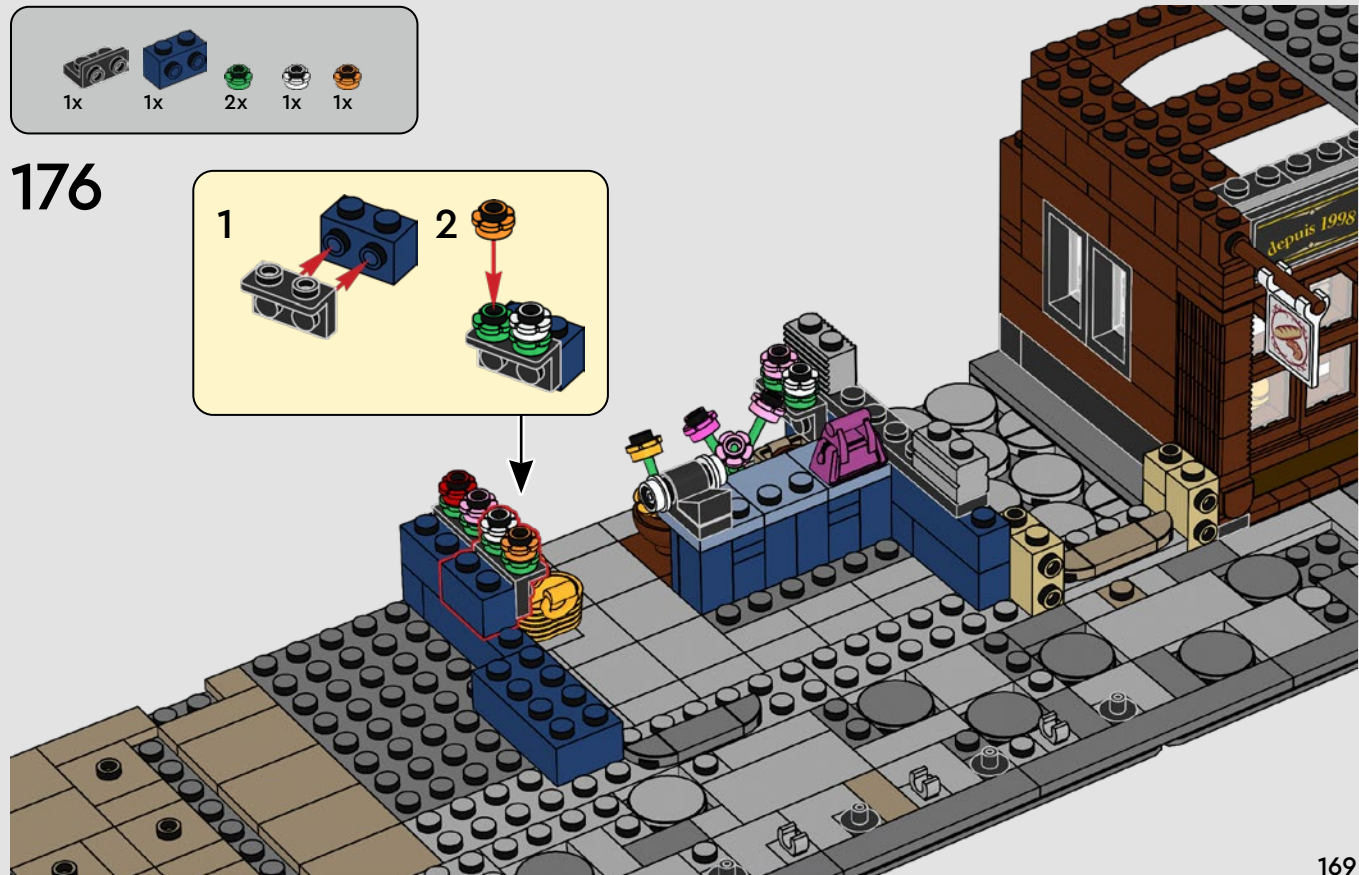
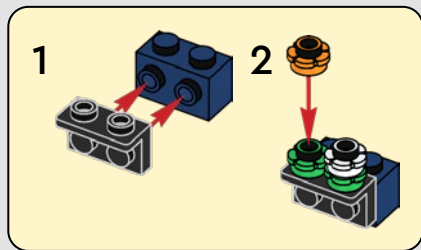

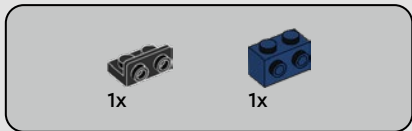

177

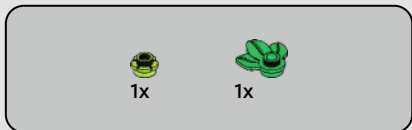
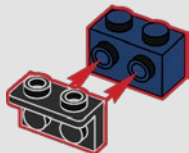

178

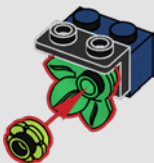

170



179

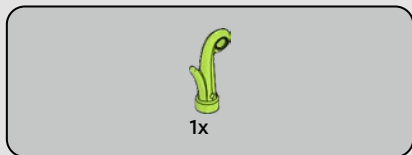
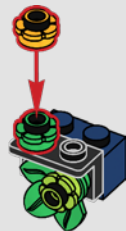

180



181

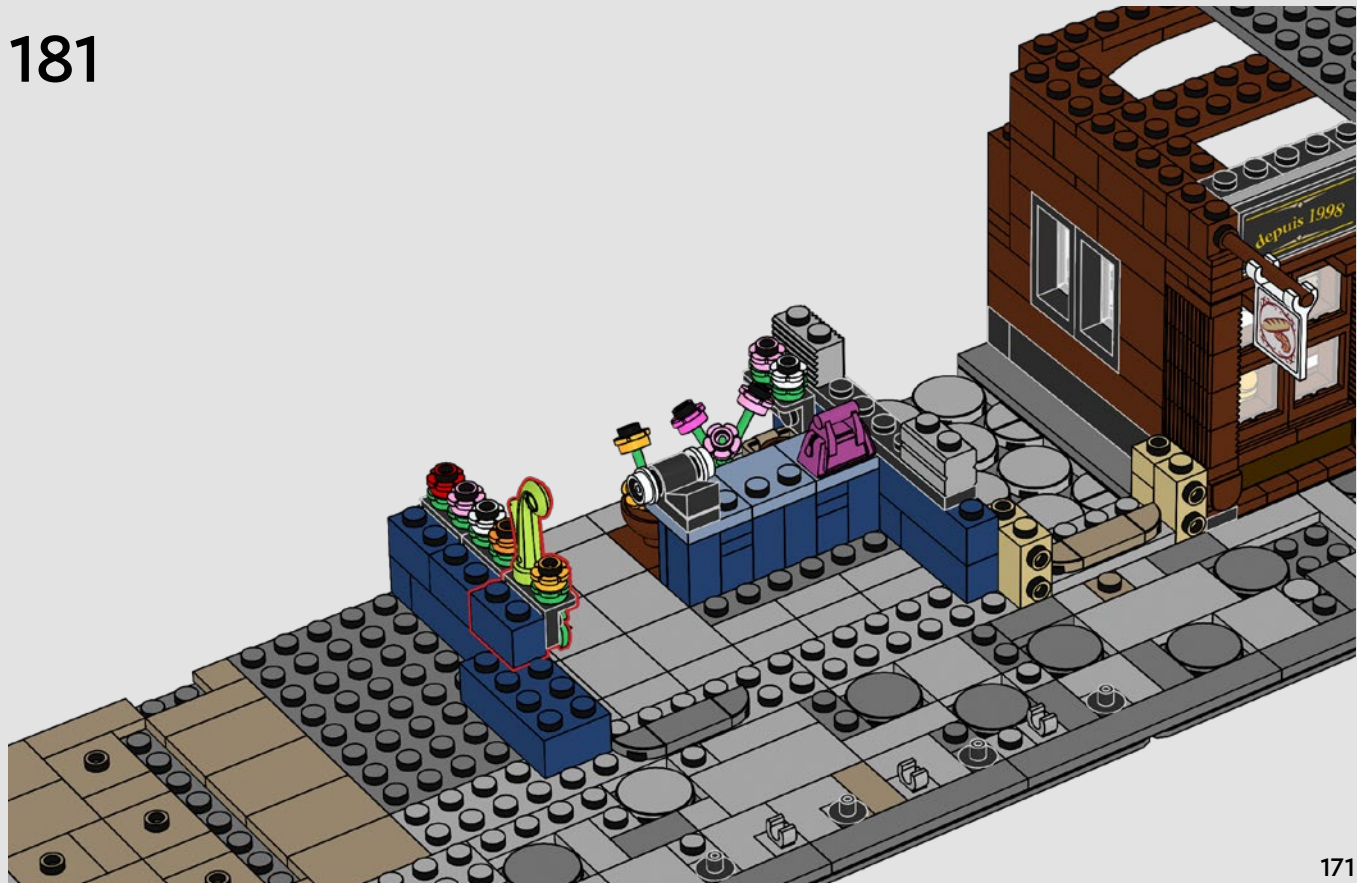

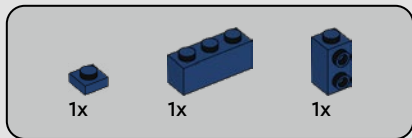

182

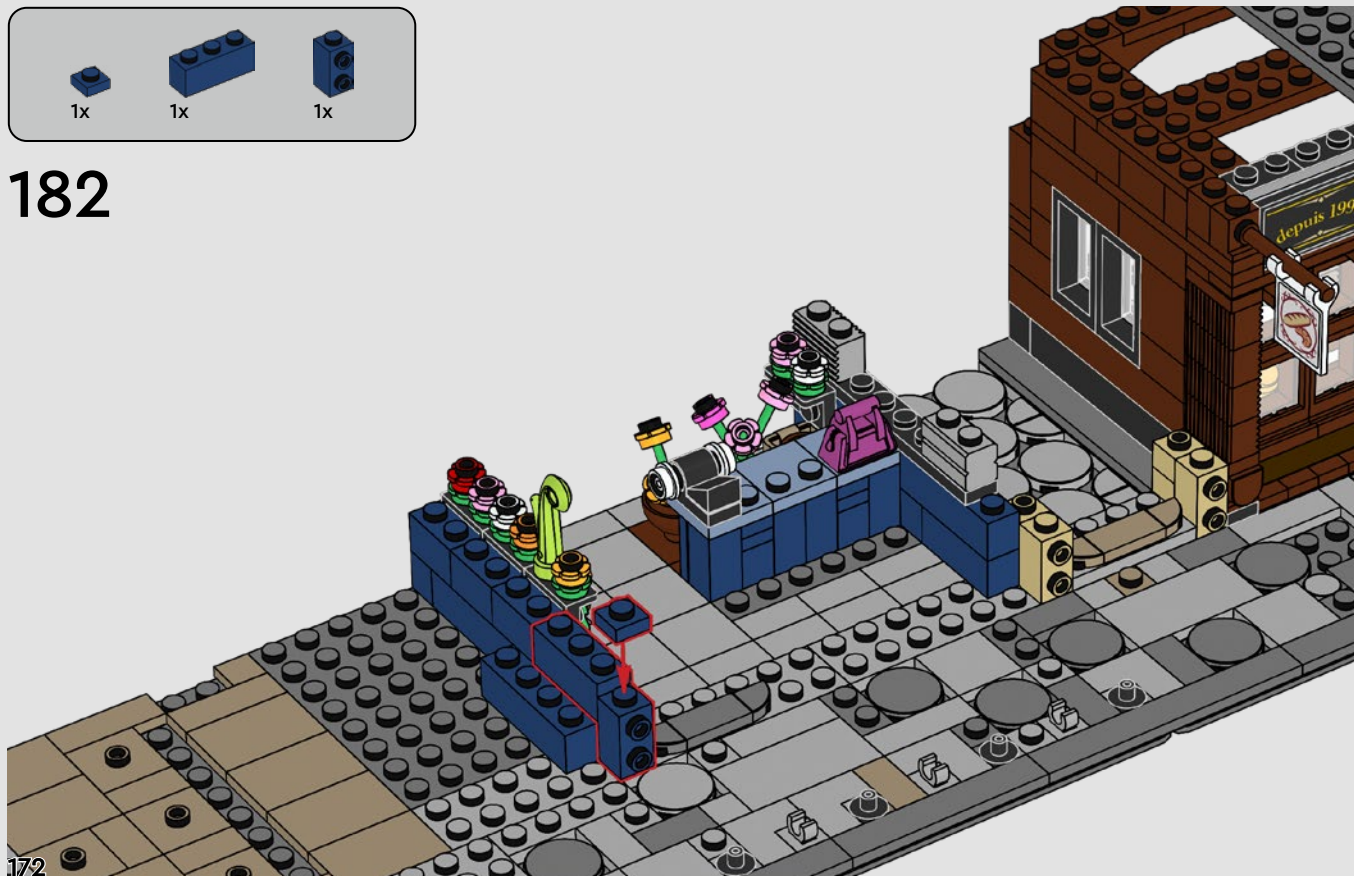



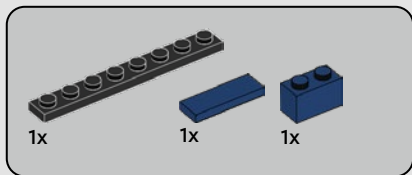

183

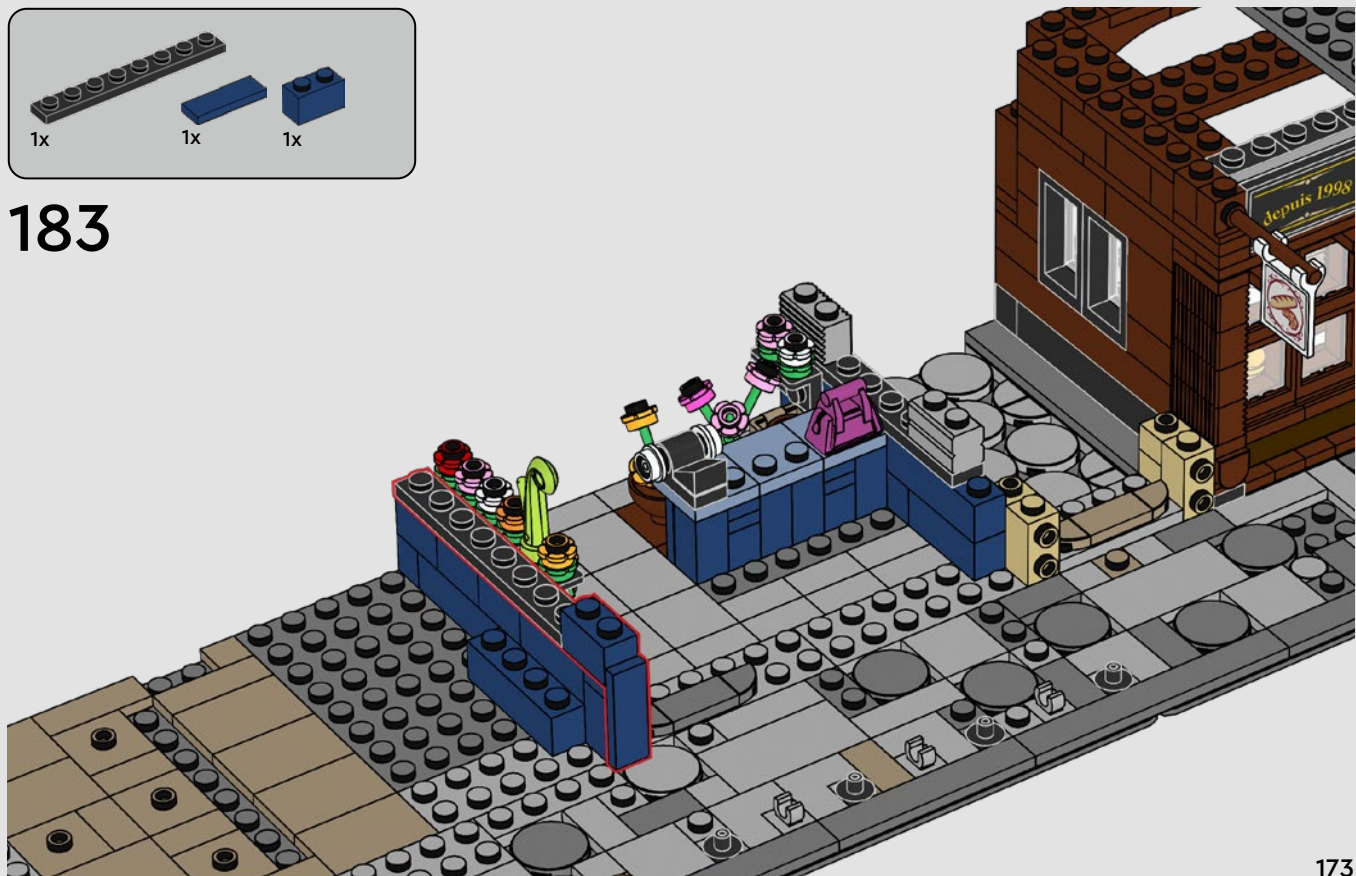



1x



2x

# 184

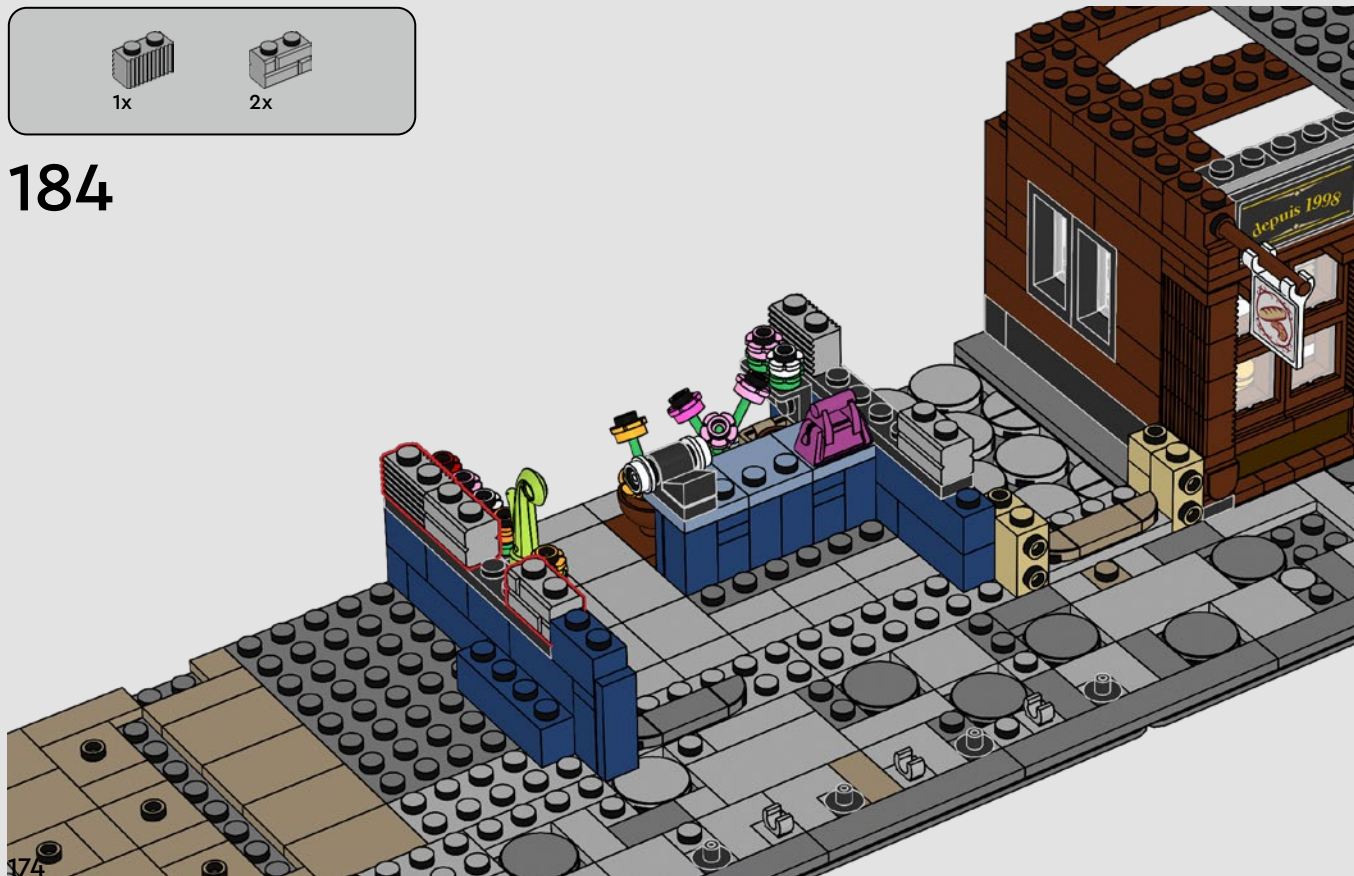

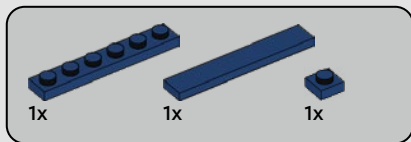

185

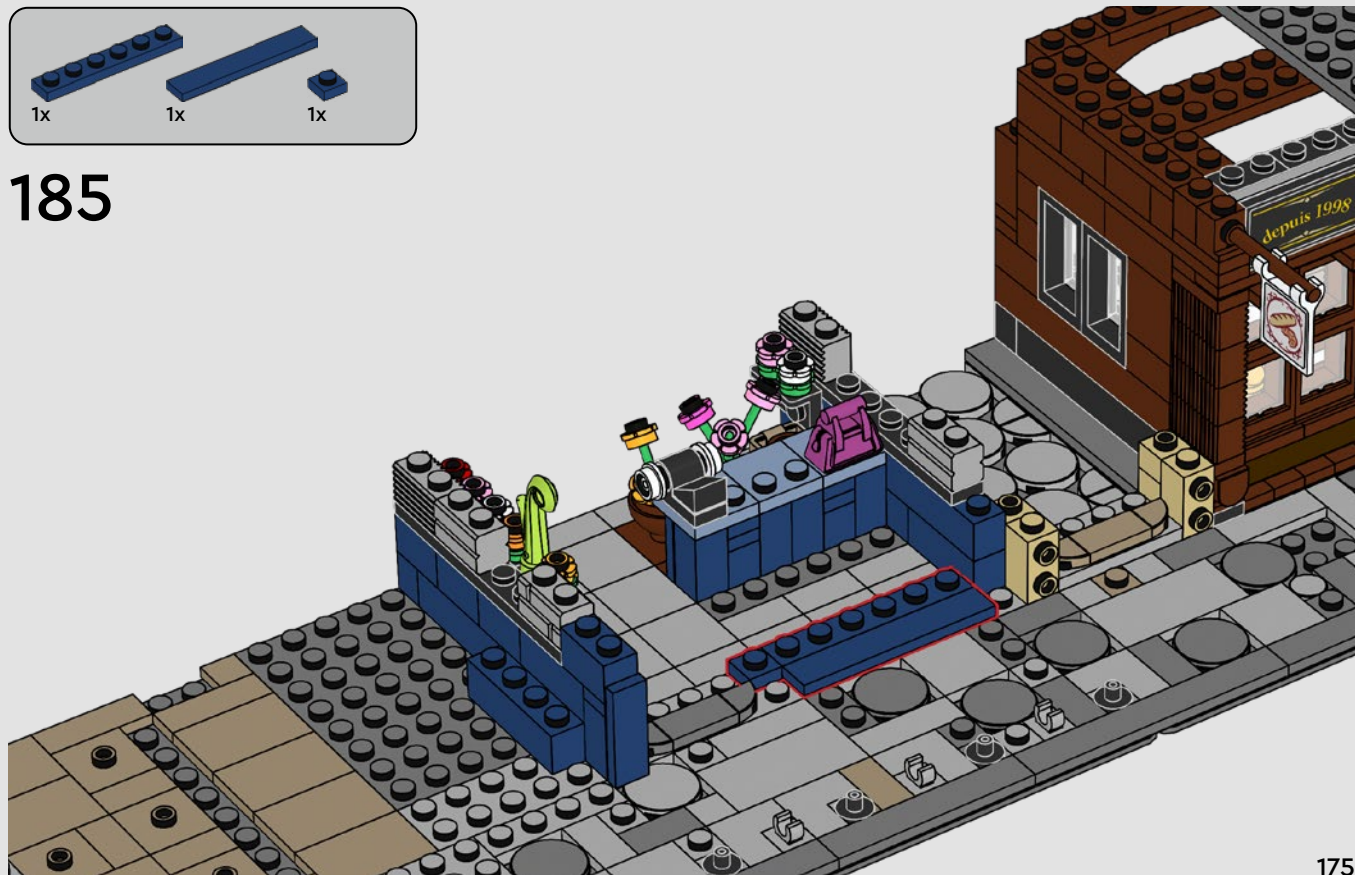

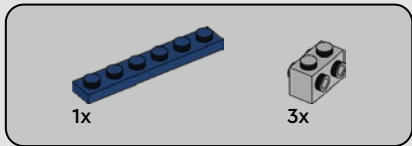
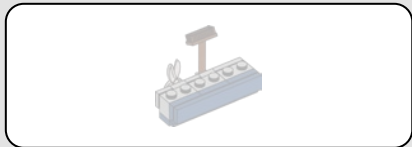

186

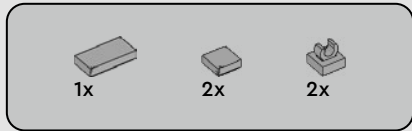
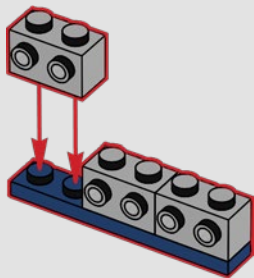

187

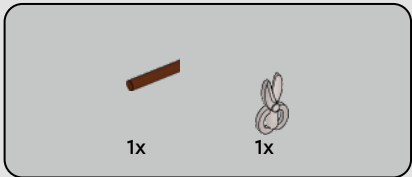
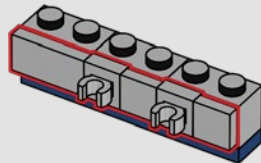

188

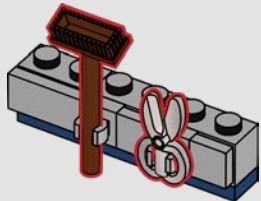





3x

189

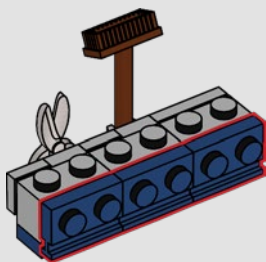

1x

190

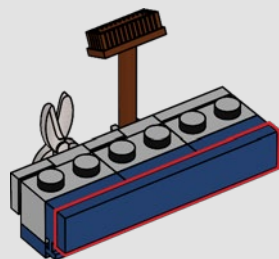

191

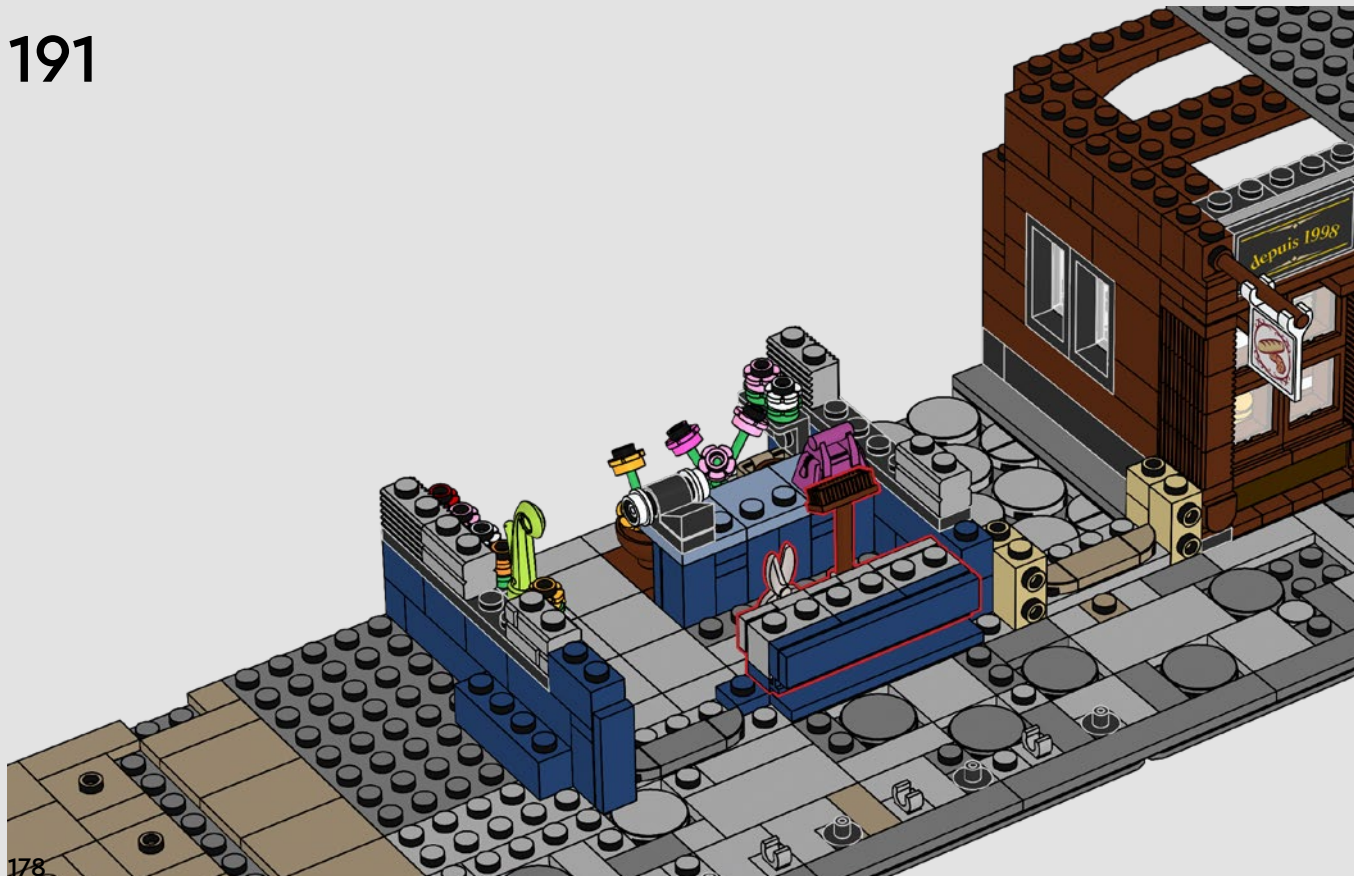



1x



1x

# 192

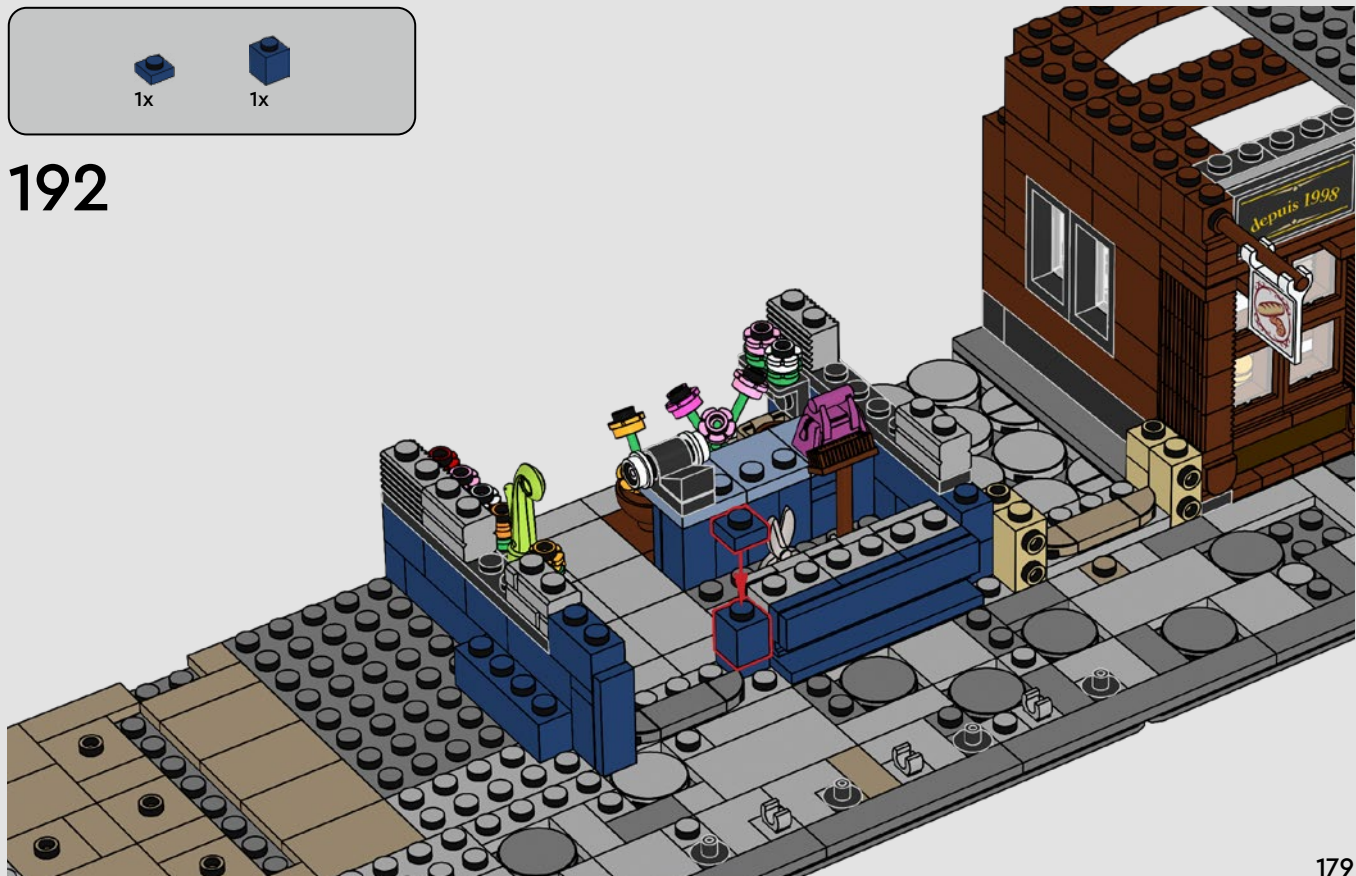



2x

193

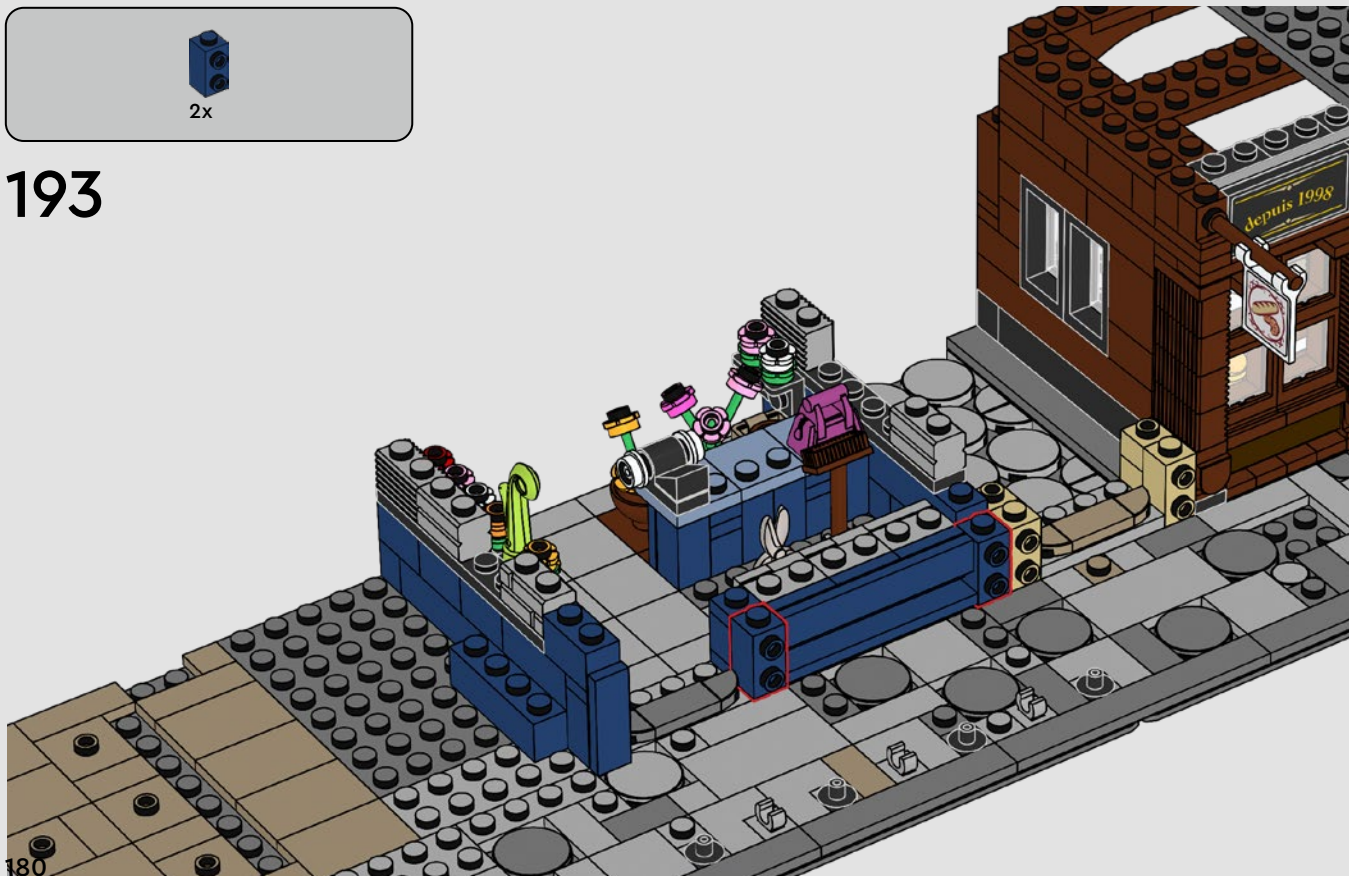



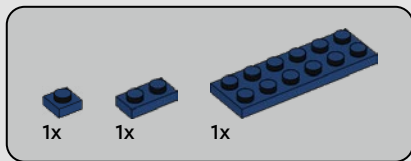

194

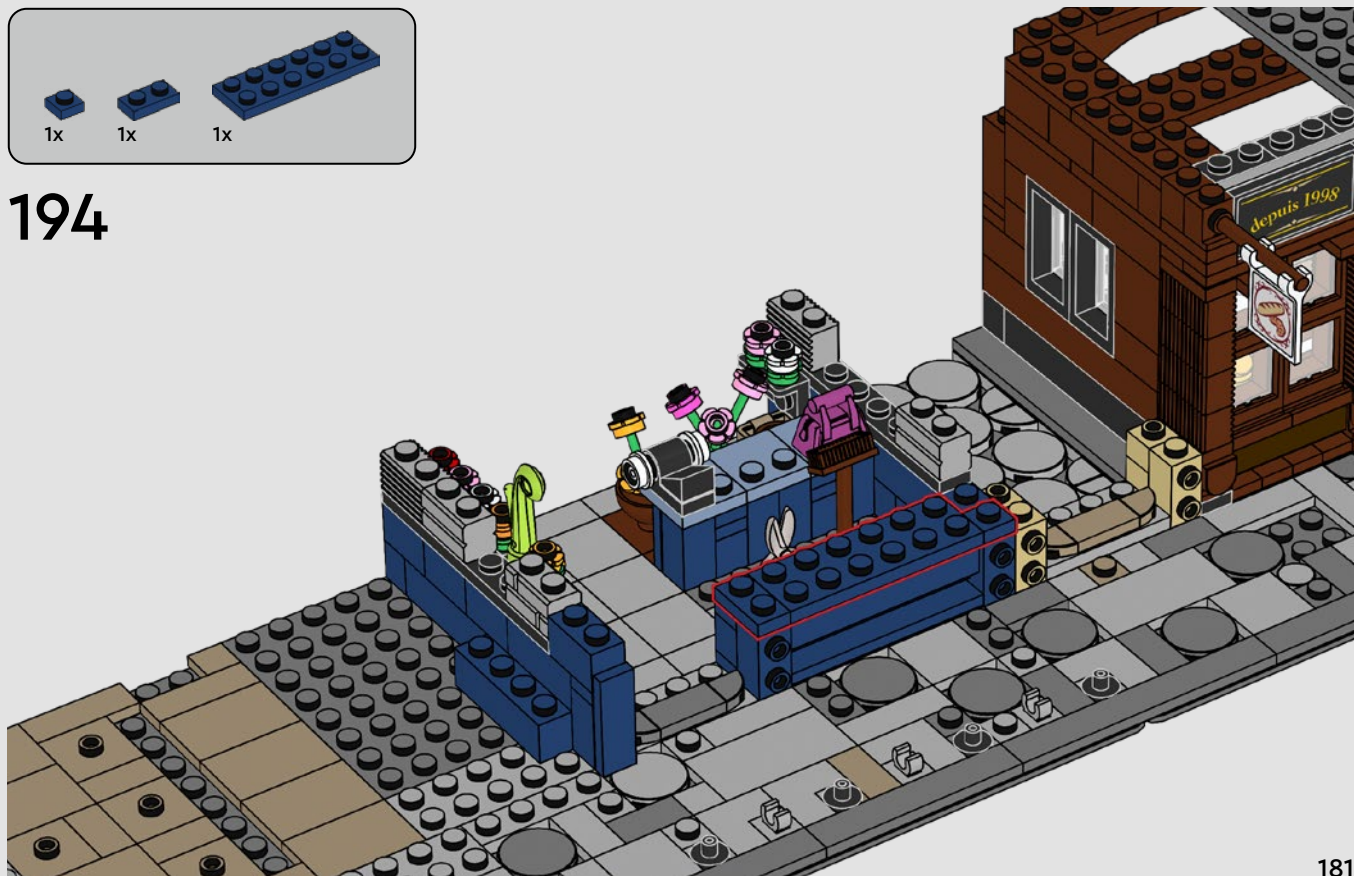

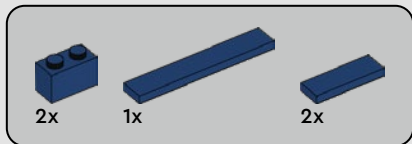

195

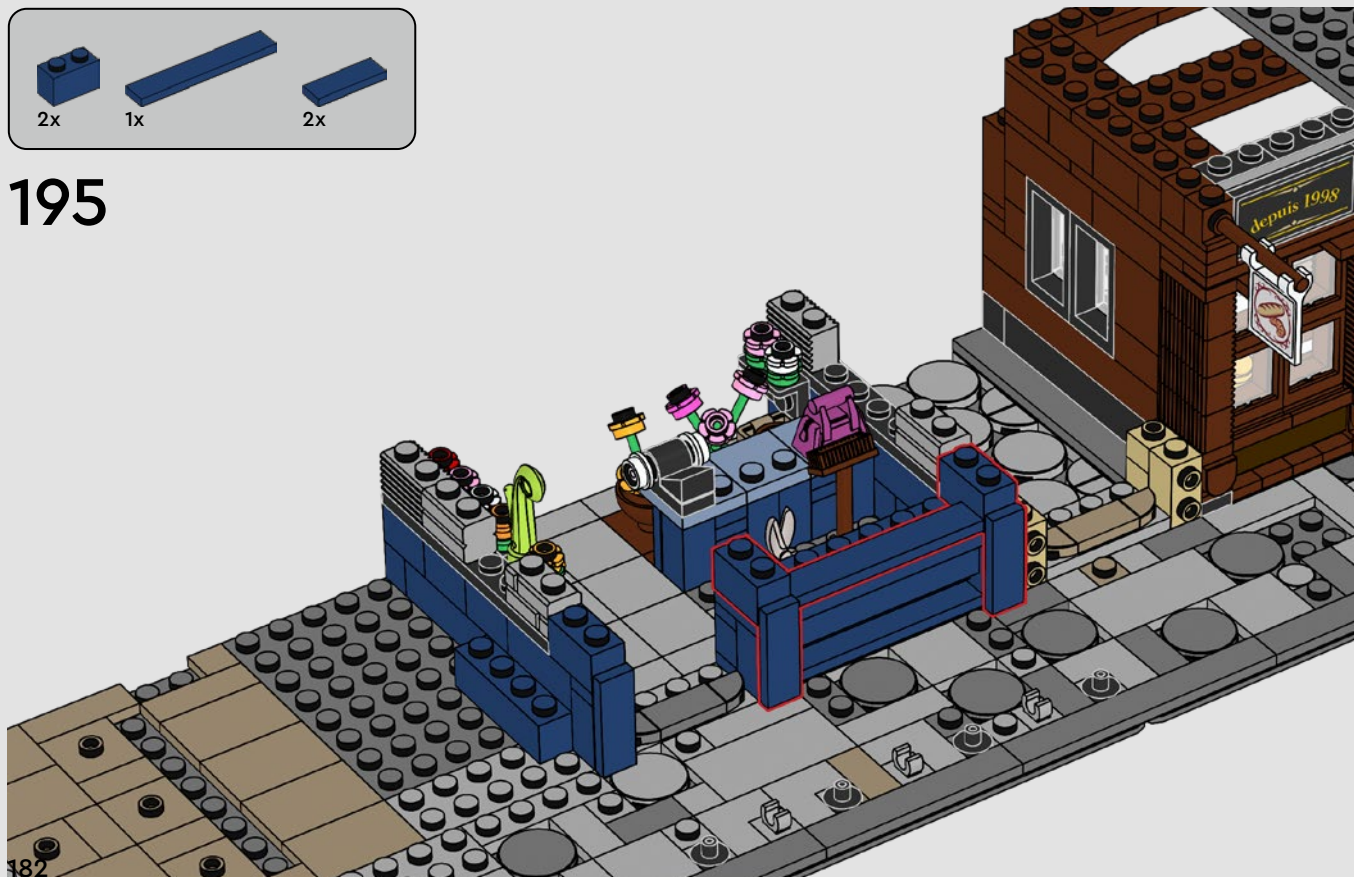

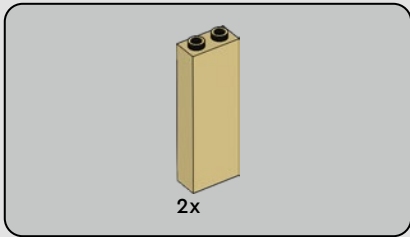

196

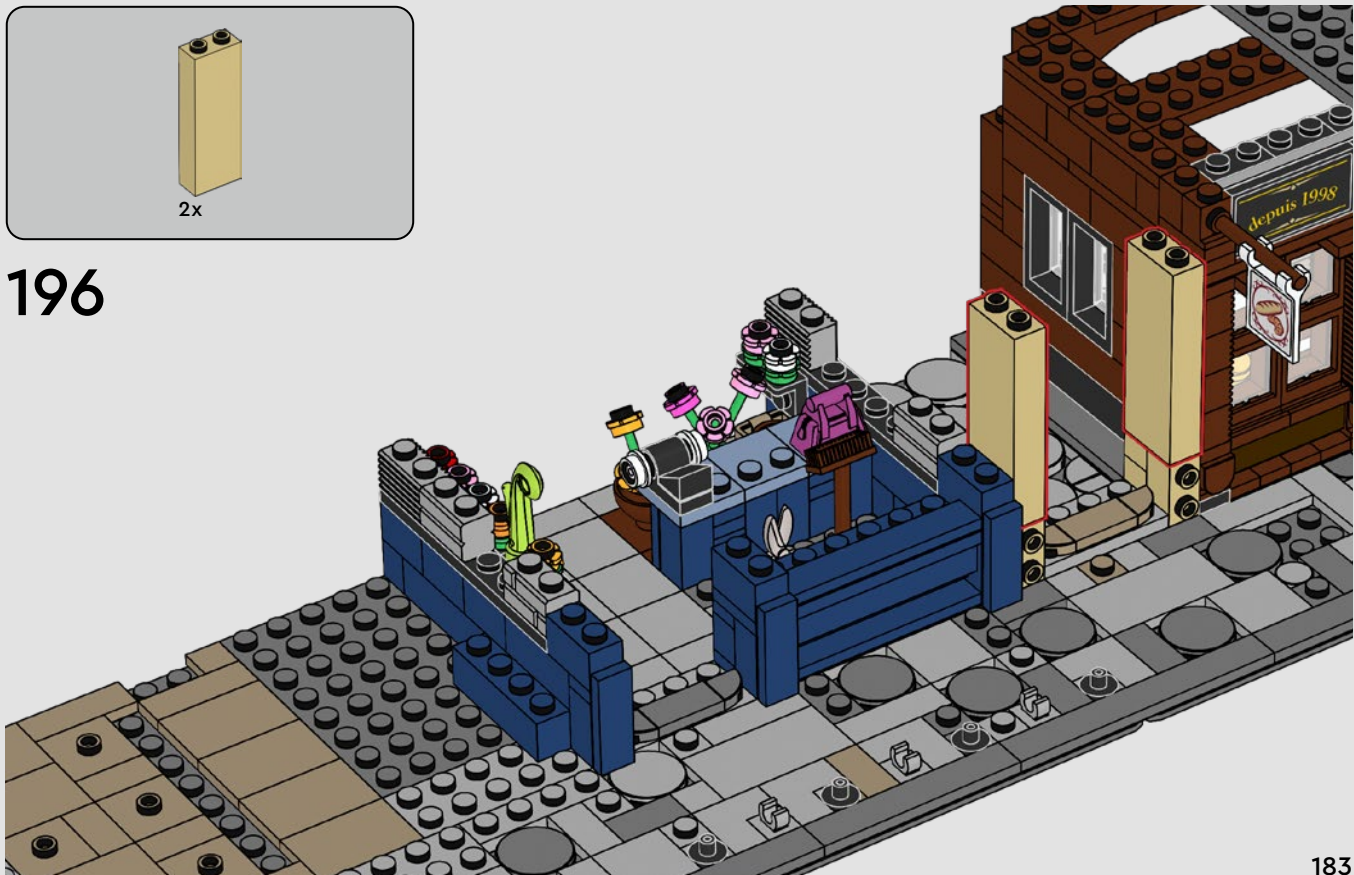

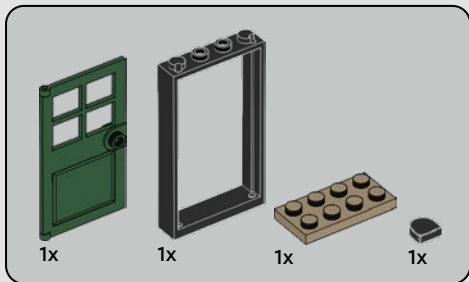

197

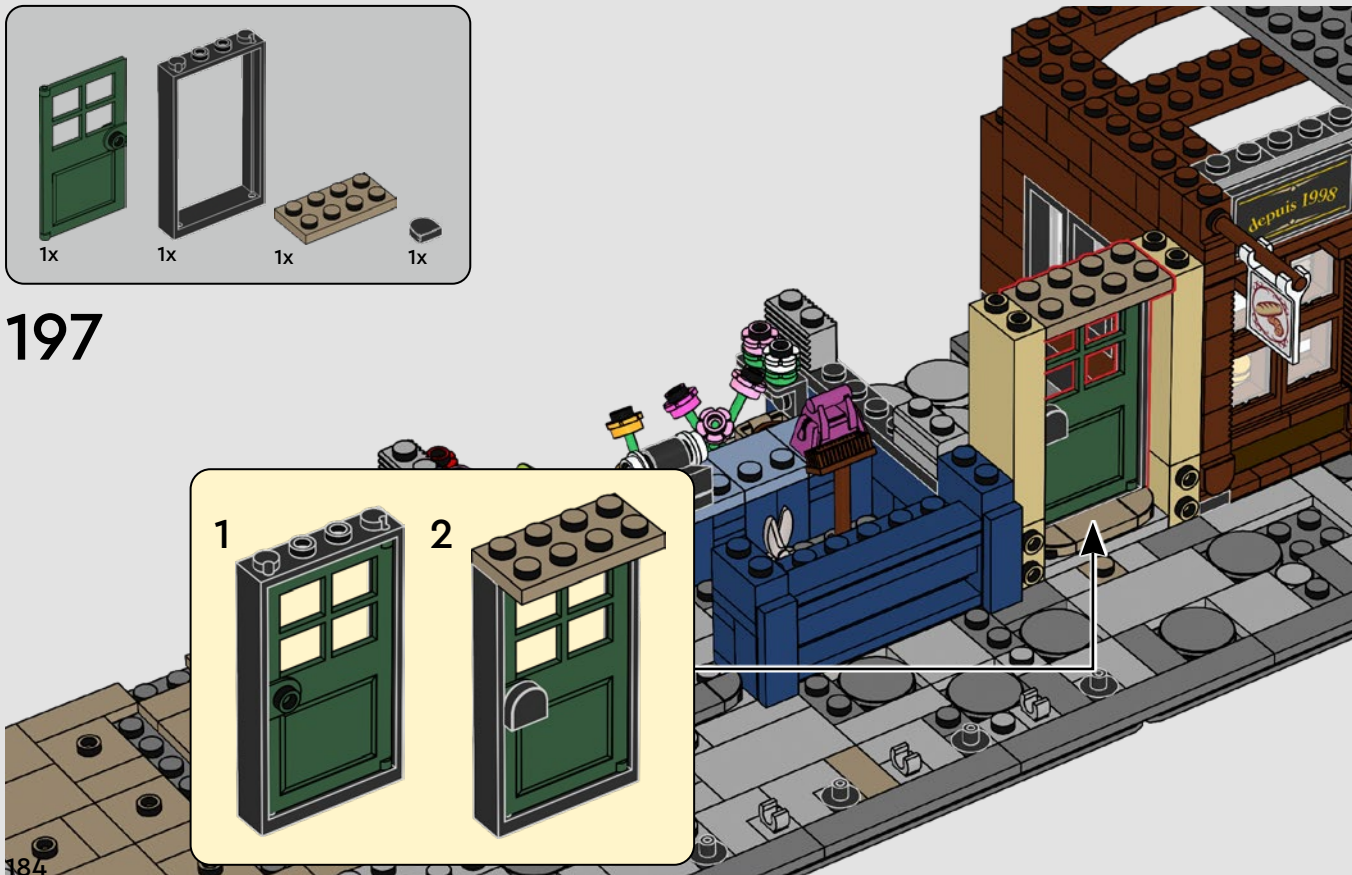
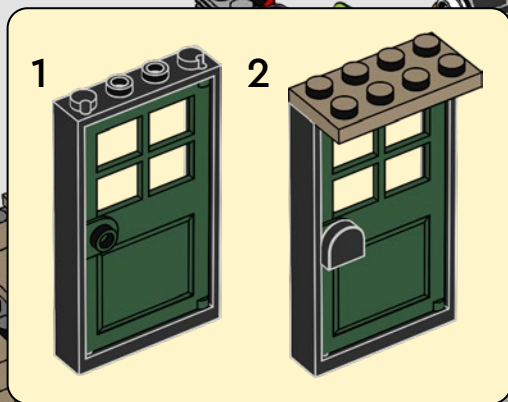



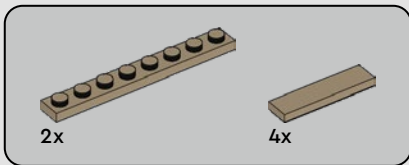

198

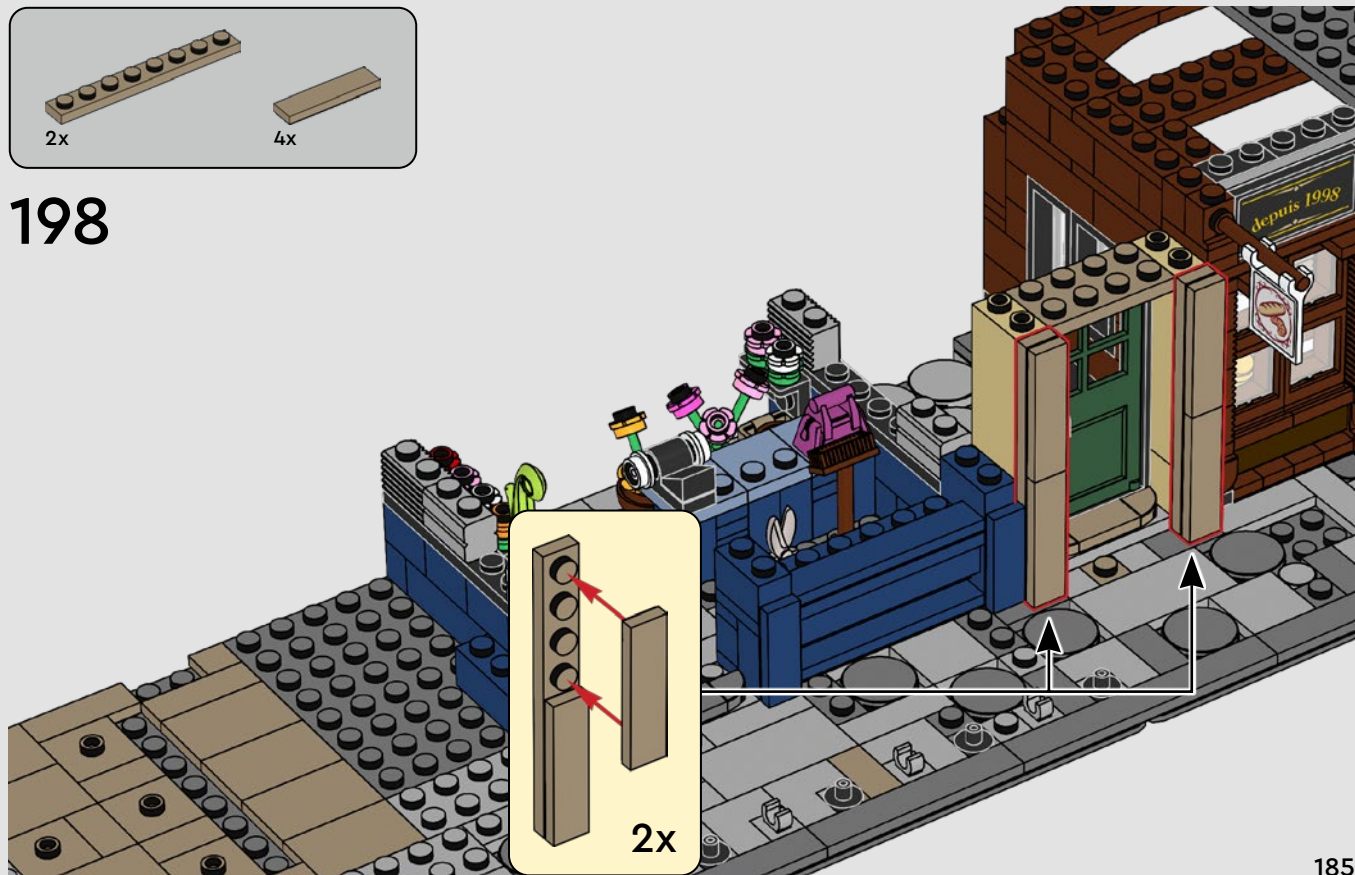

4x

4

199

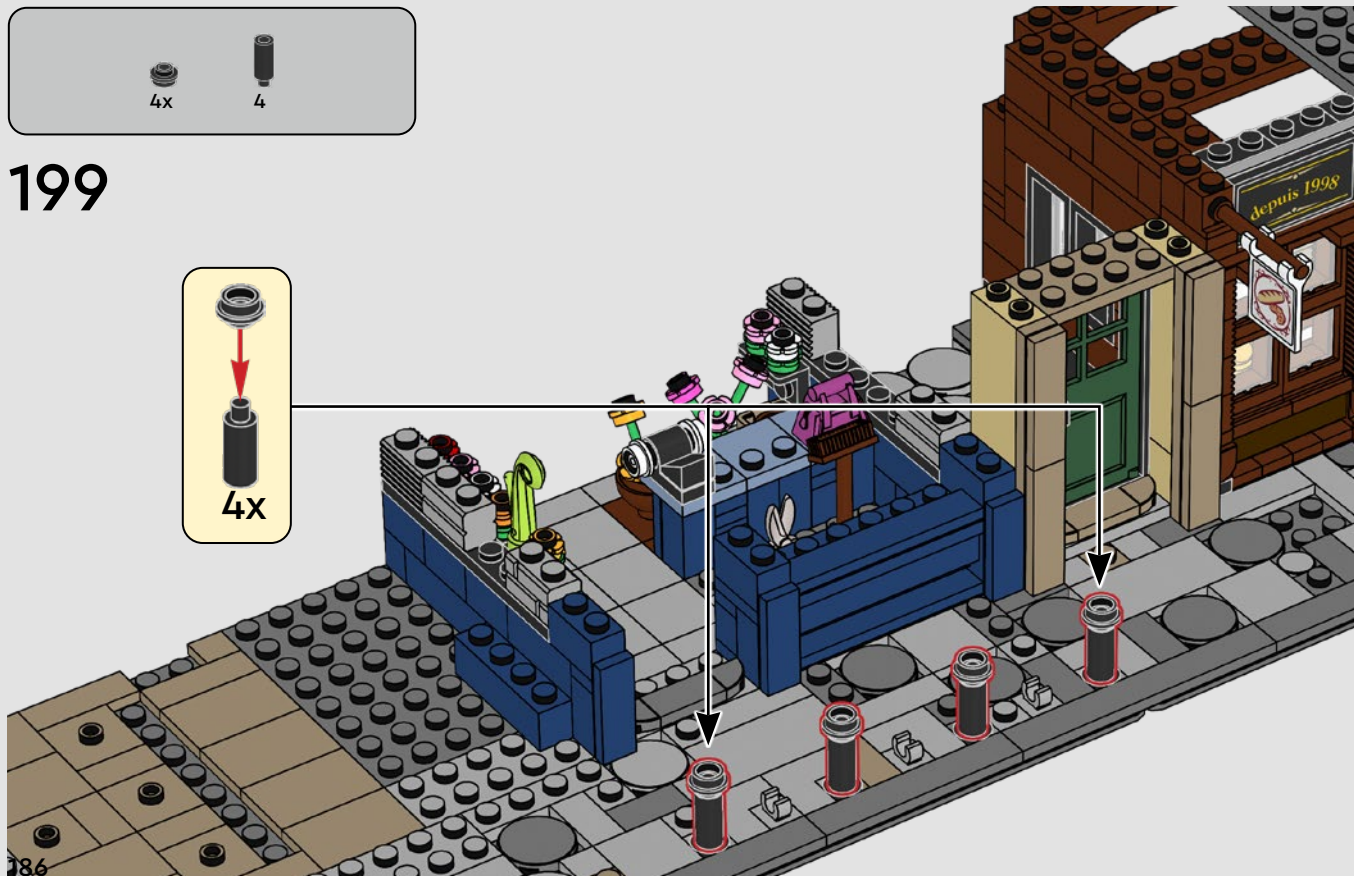
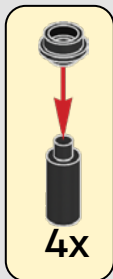



3x

200

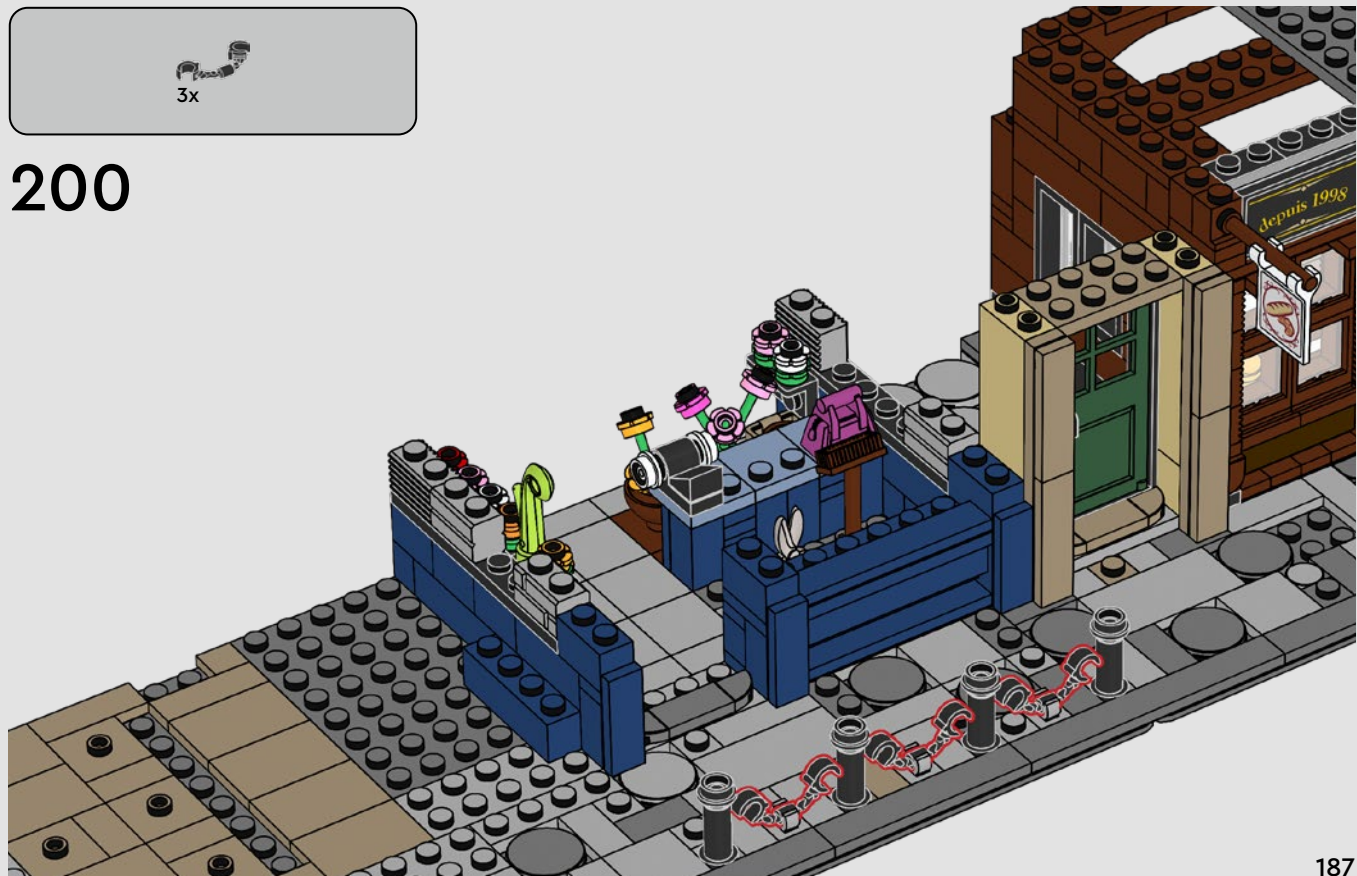





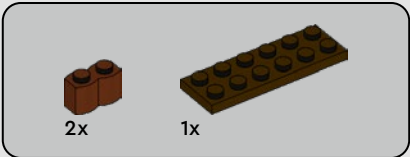
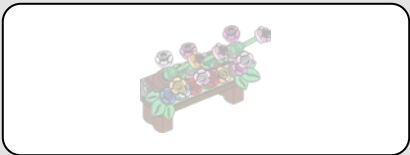

201

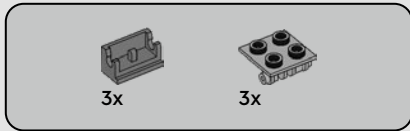
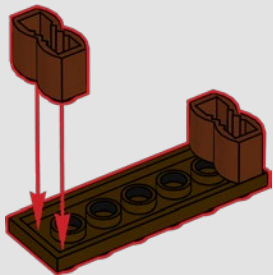

202

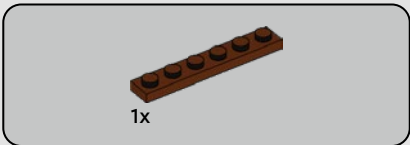
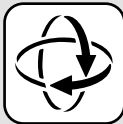
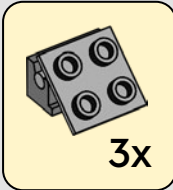
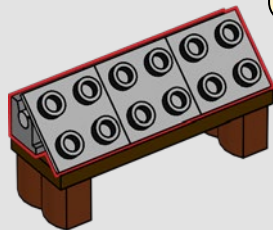

203

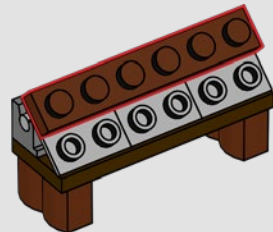



# 204

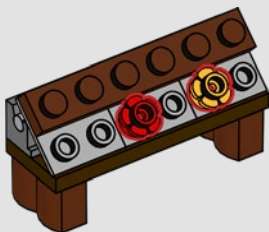

# 205

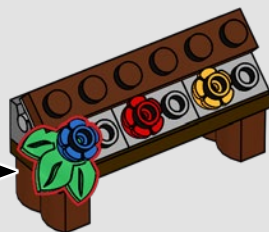

190



# 206

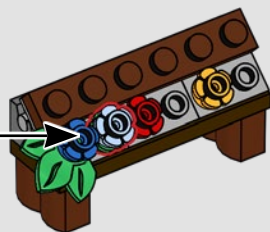

# 207

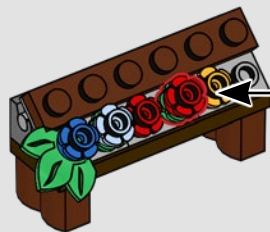

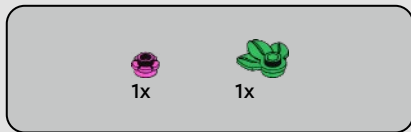

208

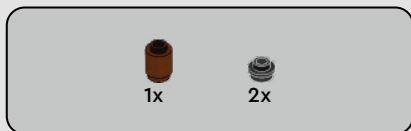
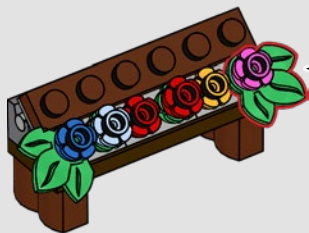

209

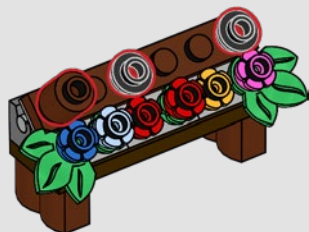

210

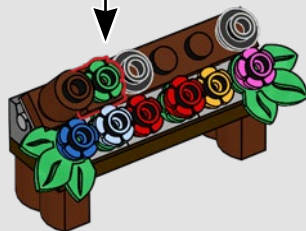



1x



2x



# 211

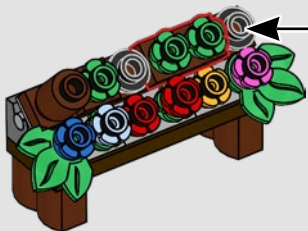

1x



2x



1x



# 212



2x



4x



2x

# 213

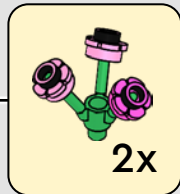

2x





214

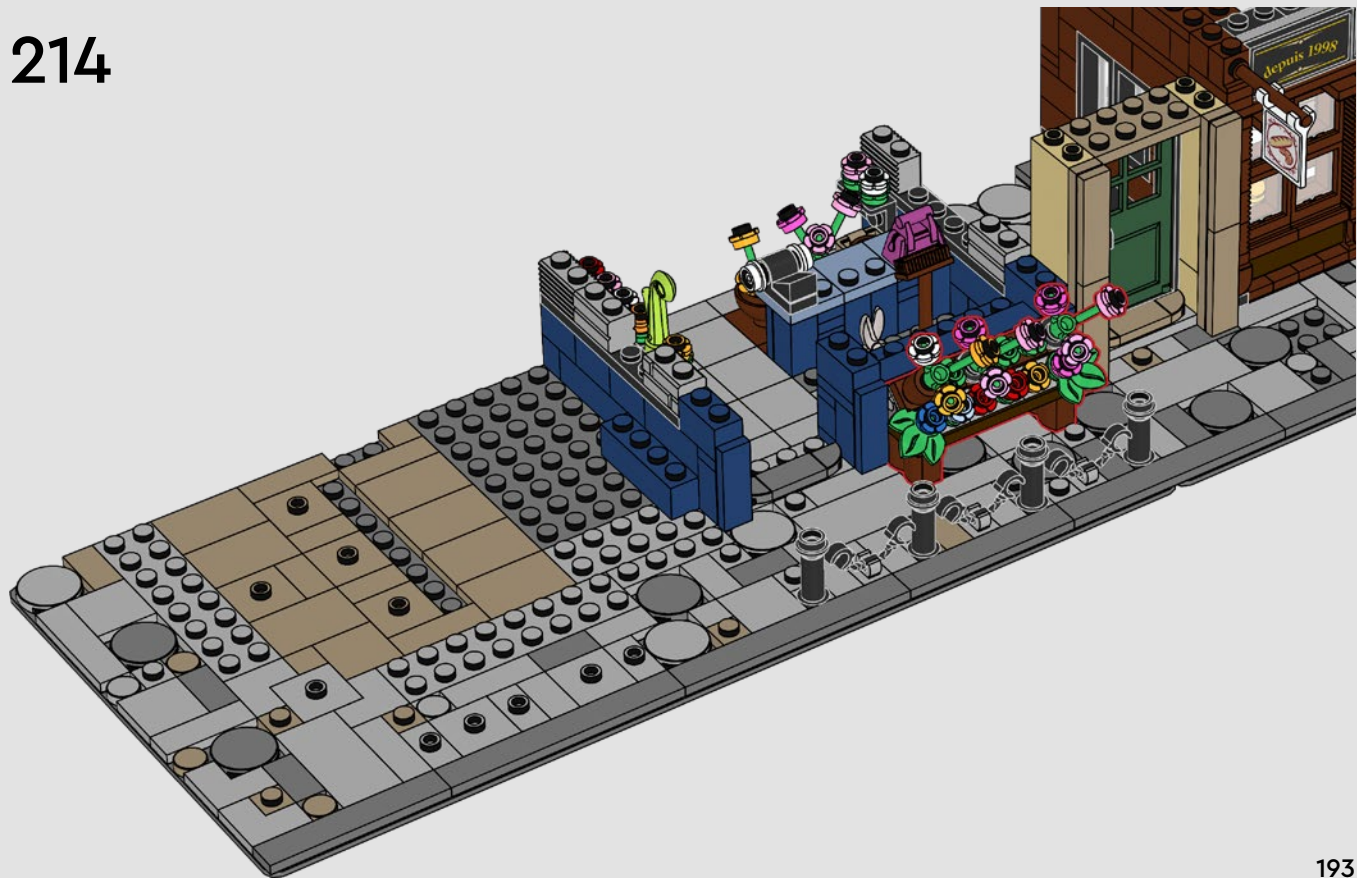

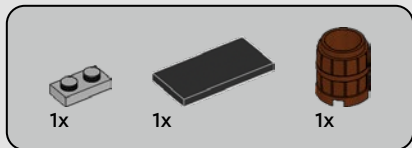

215

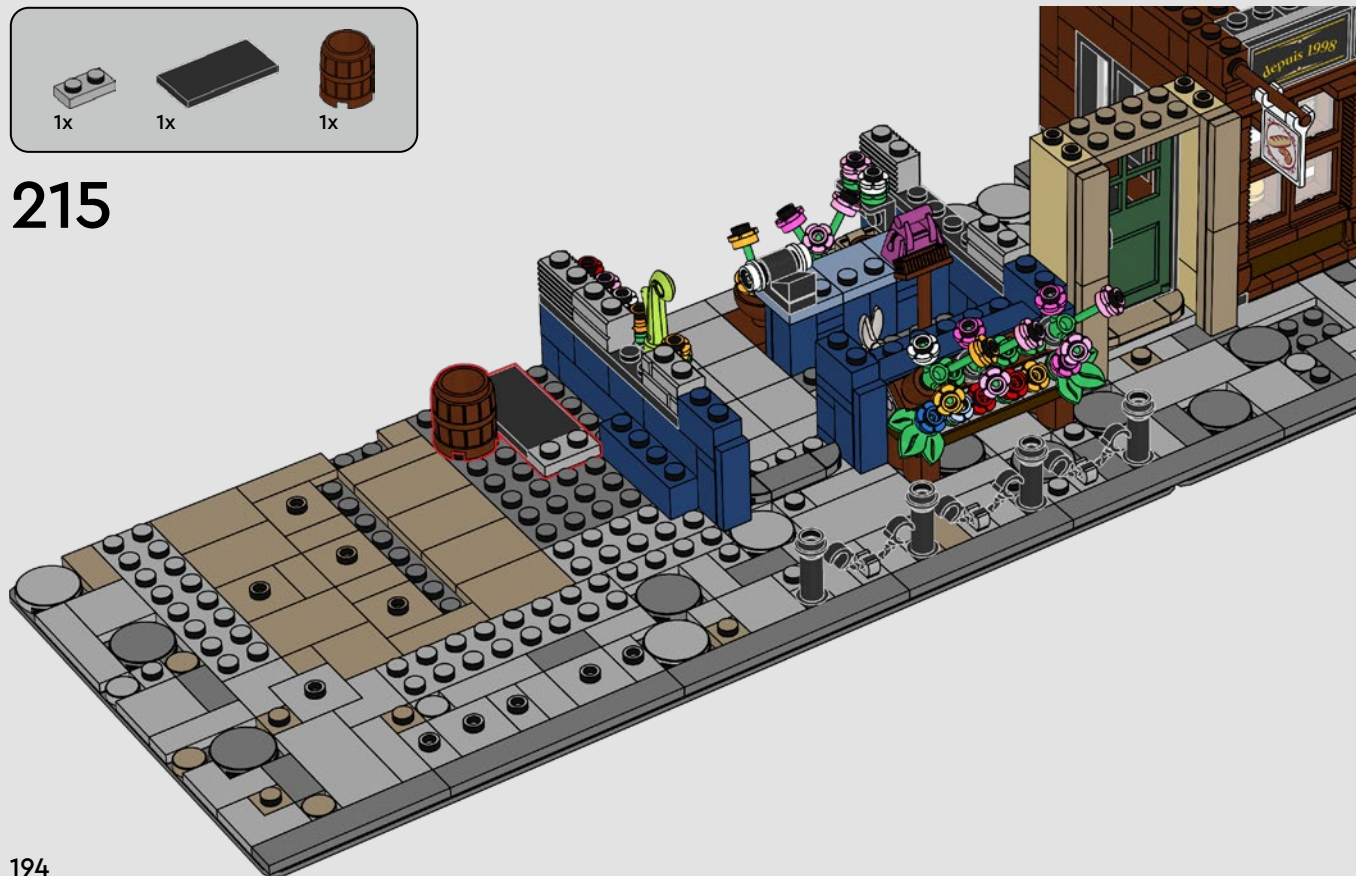

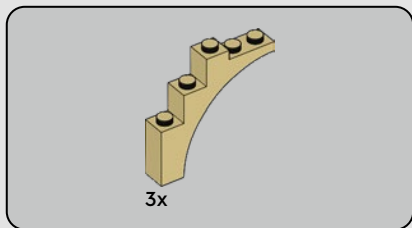

216

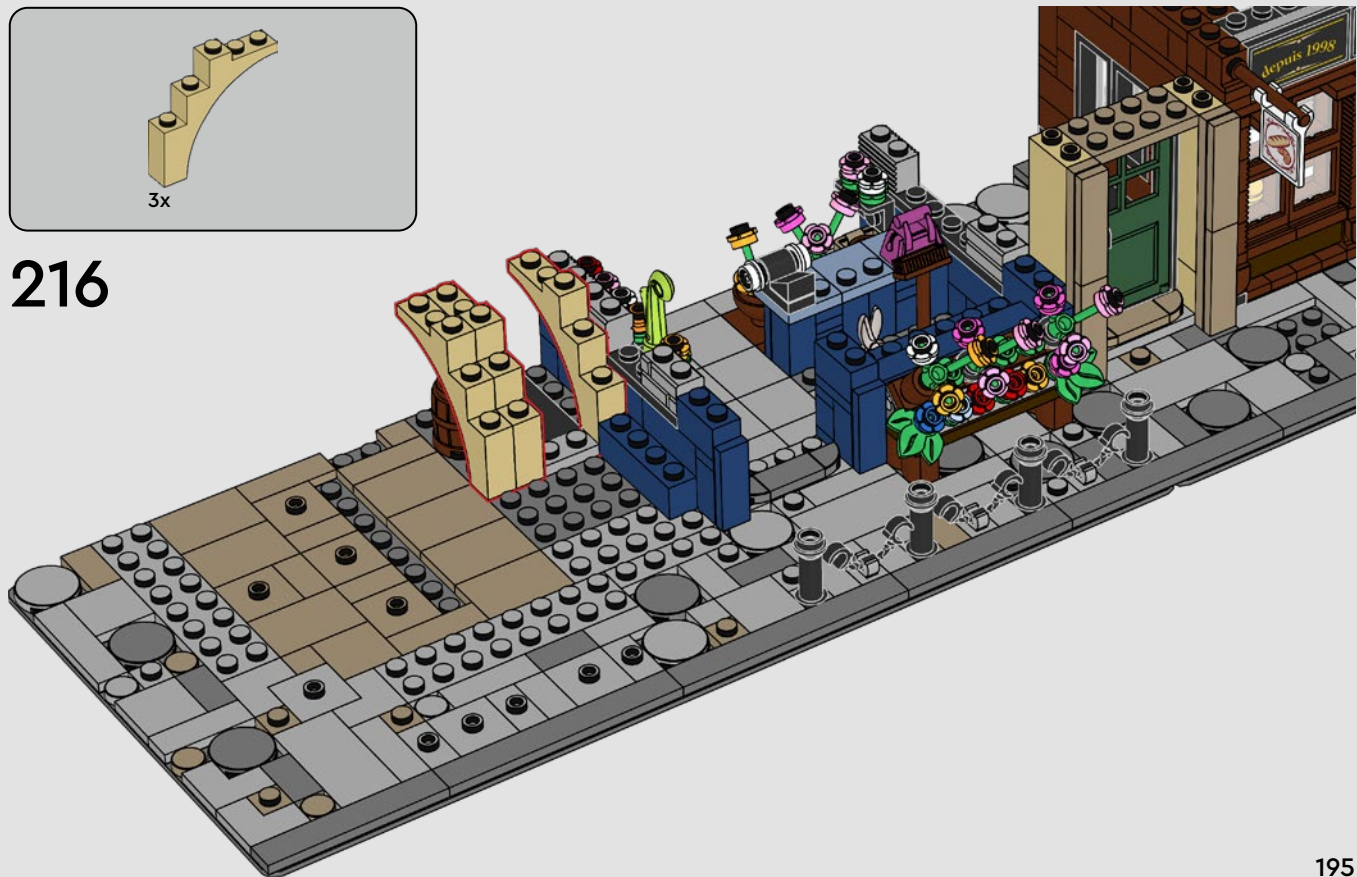



217

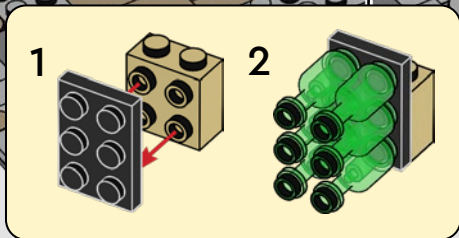
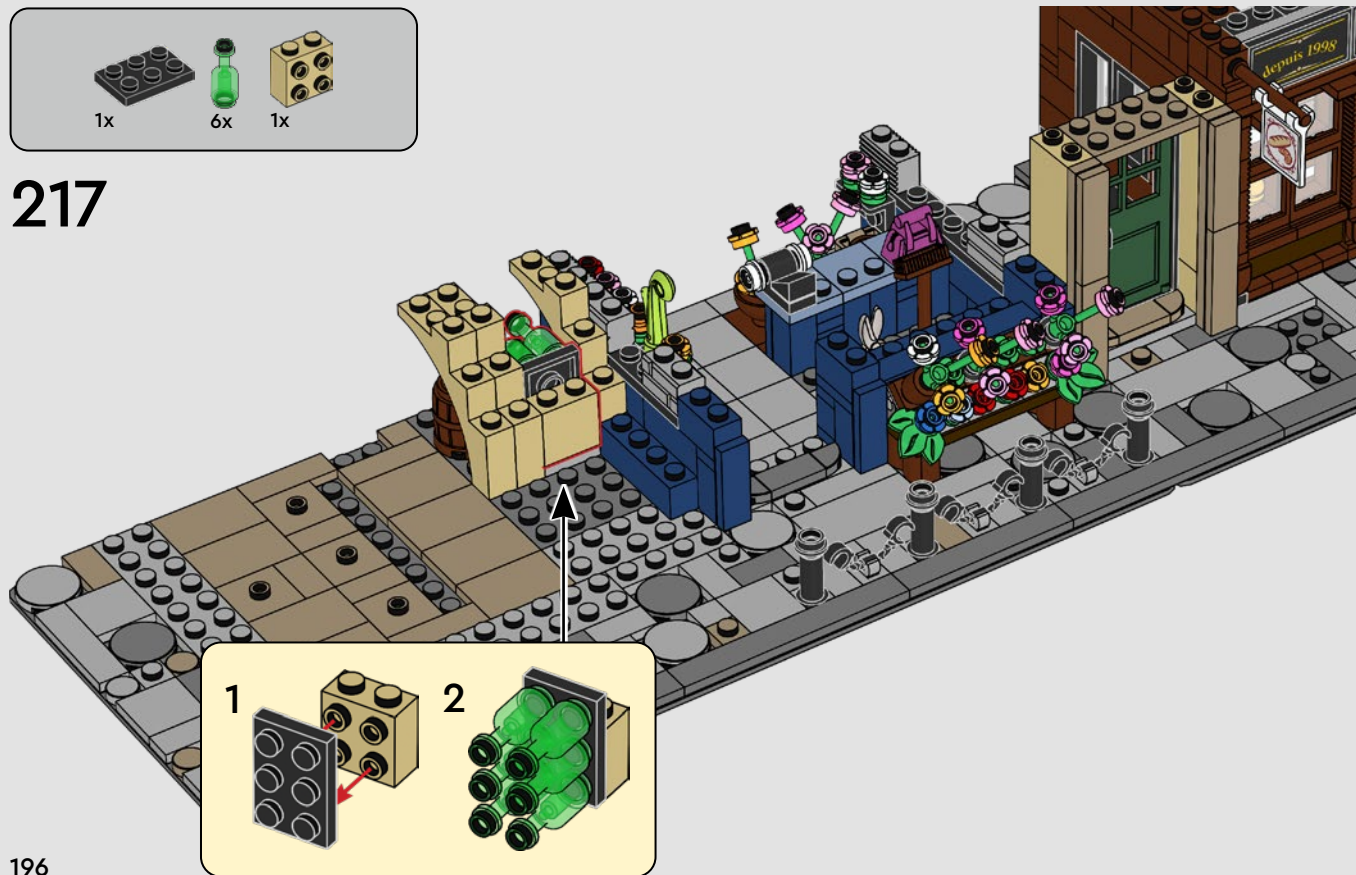



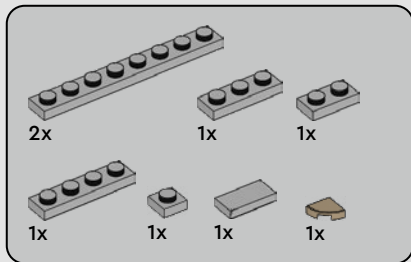

218

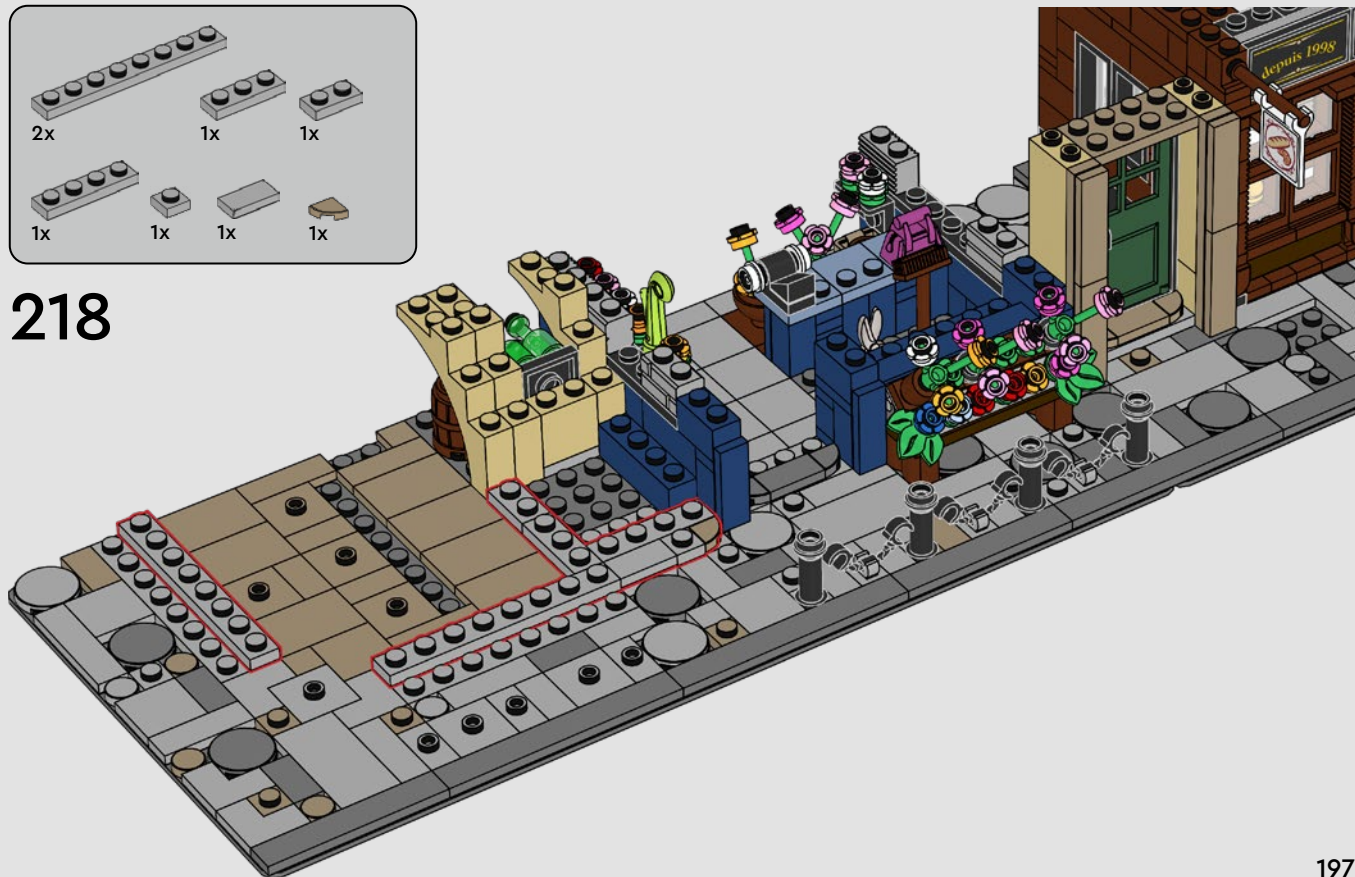



6x



4x

219

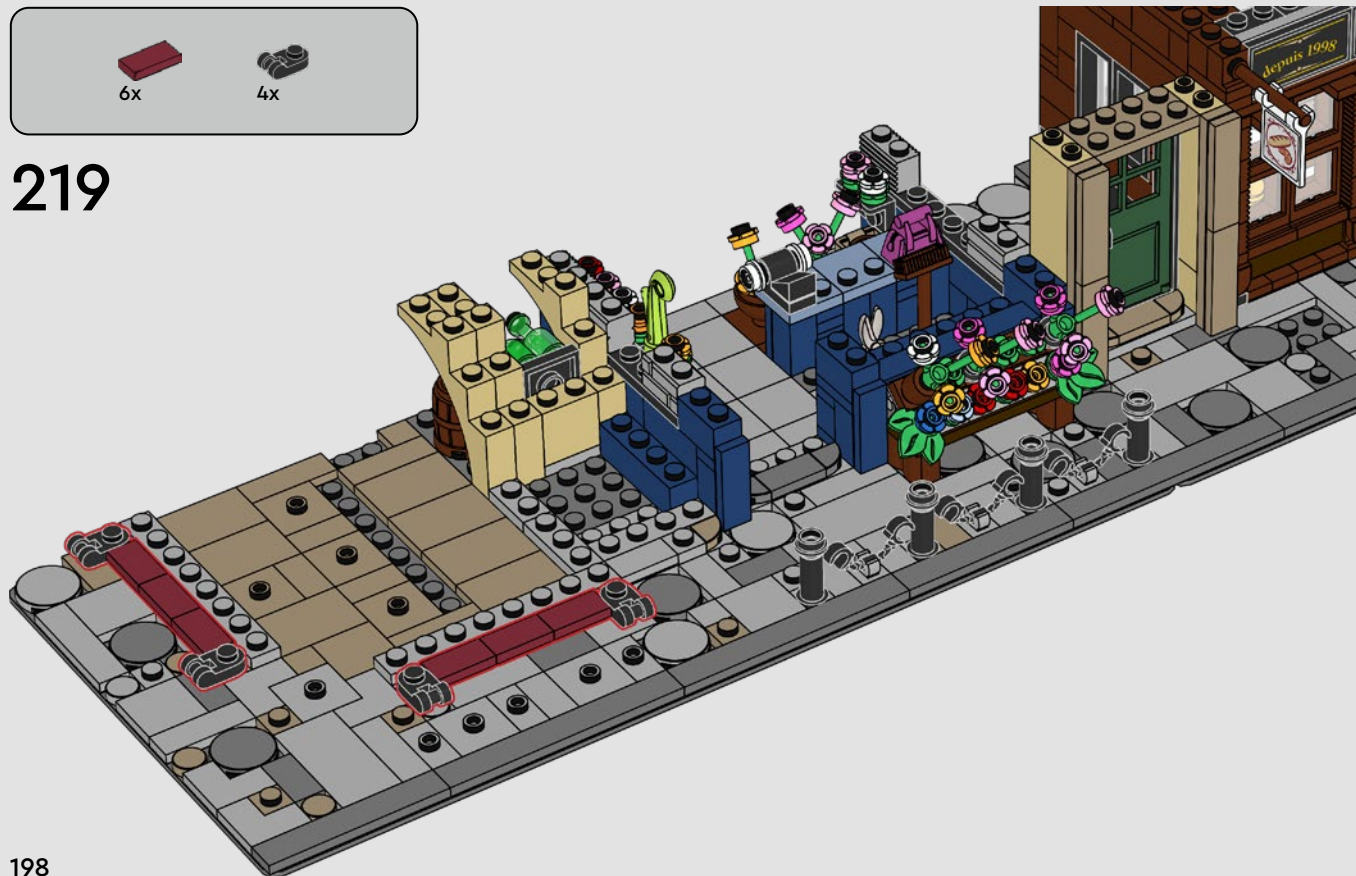



8x



4

# 220

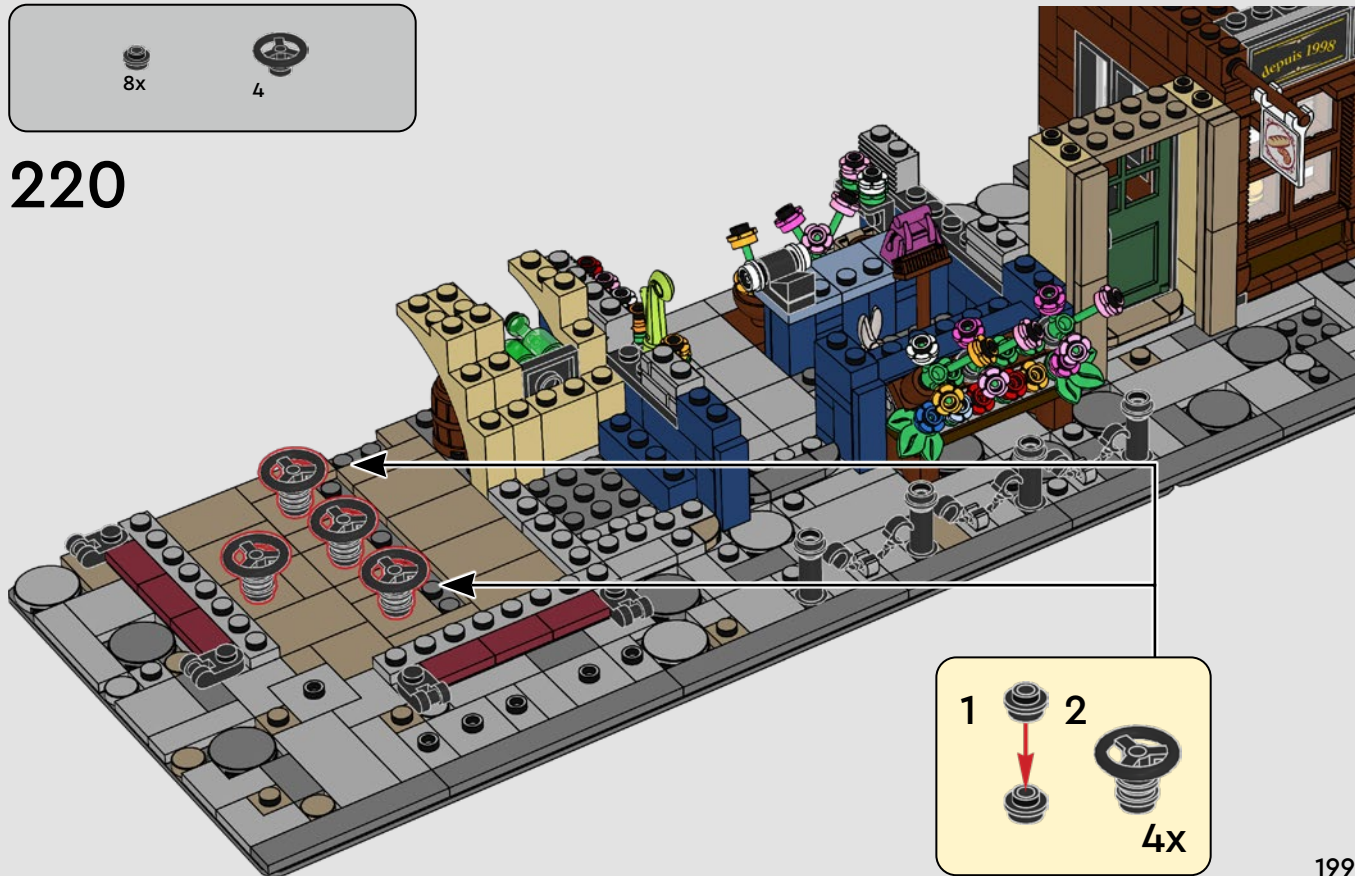

1



2



4x

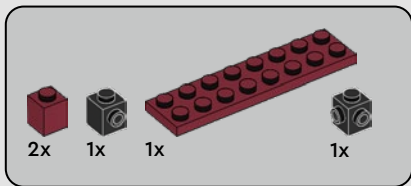
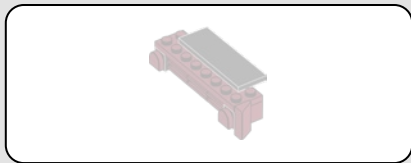

221

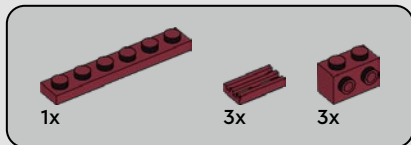
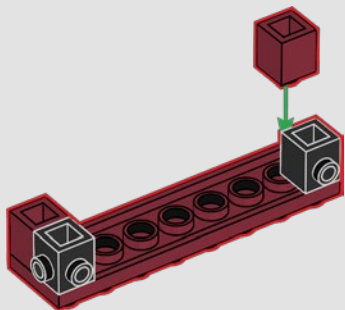

222

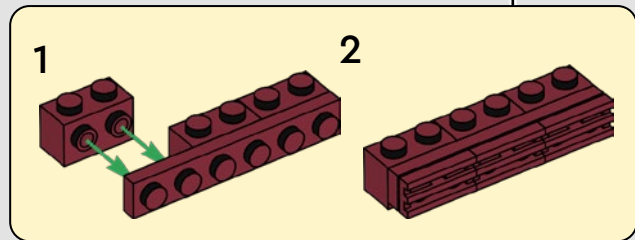
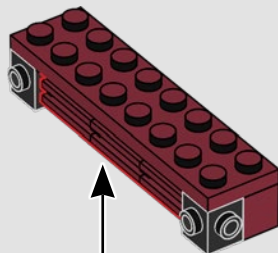



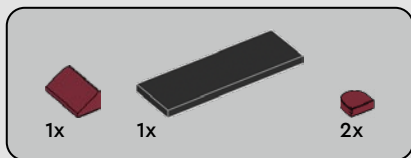

223

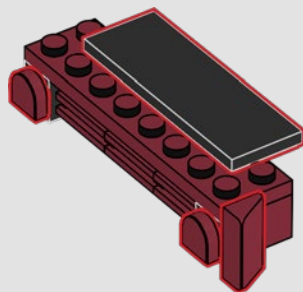

224

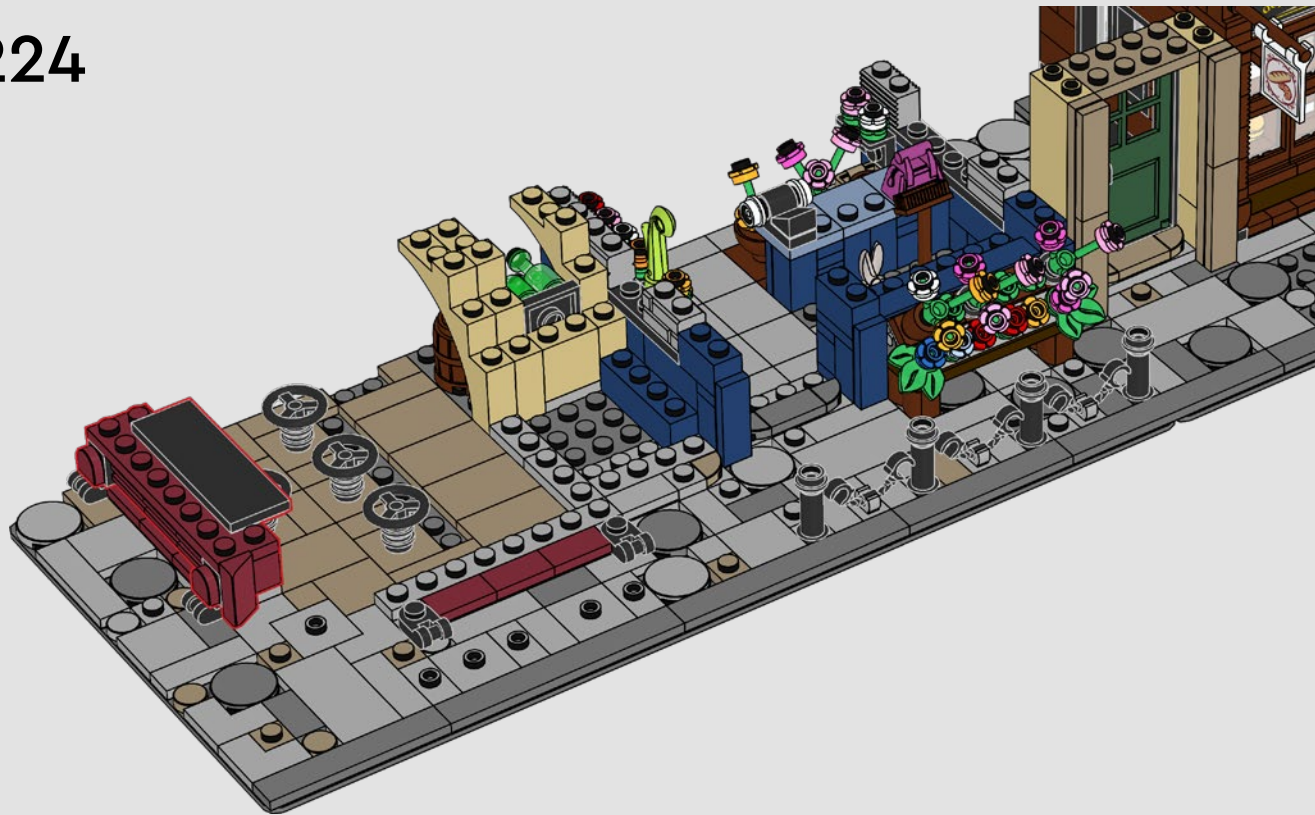

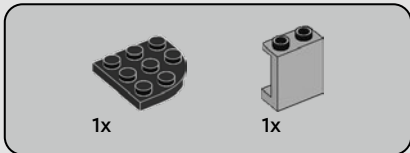
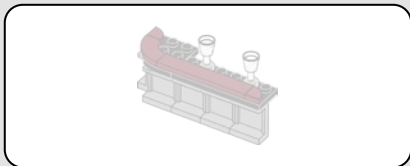

225

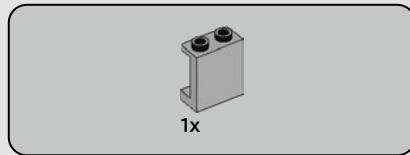
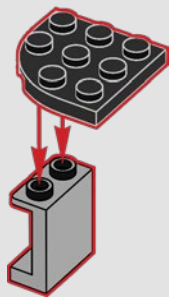

226

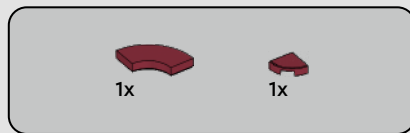
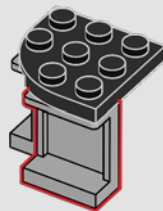

227

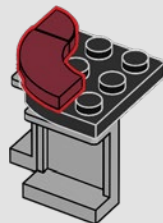

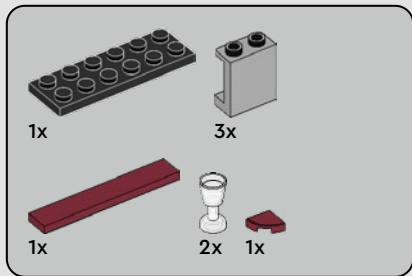

228

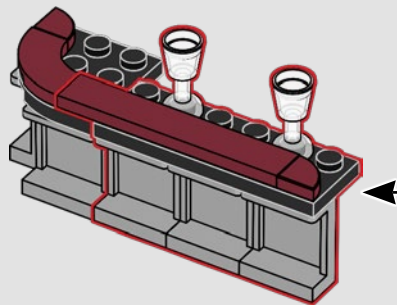
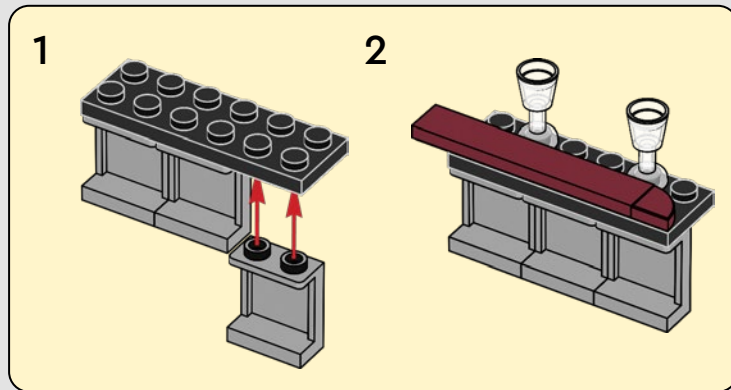



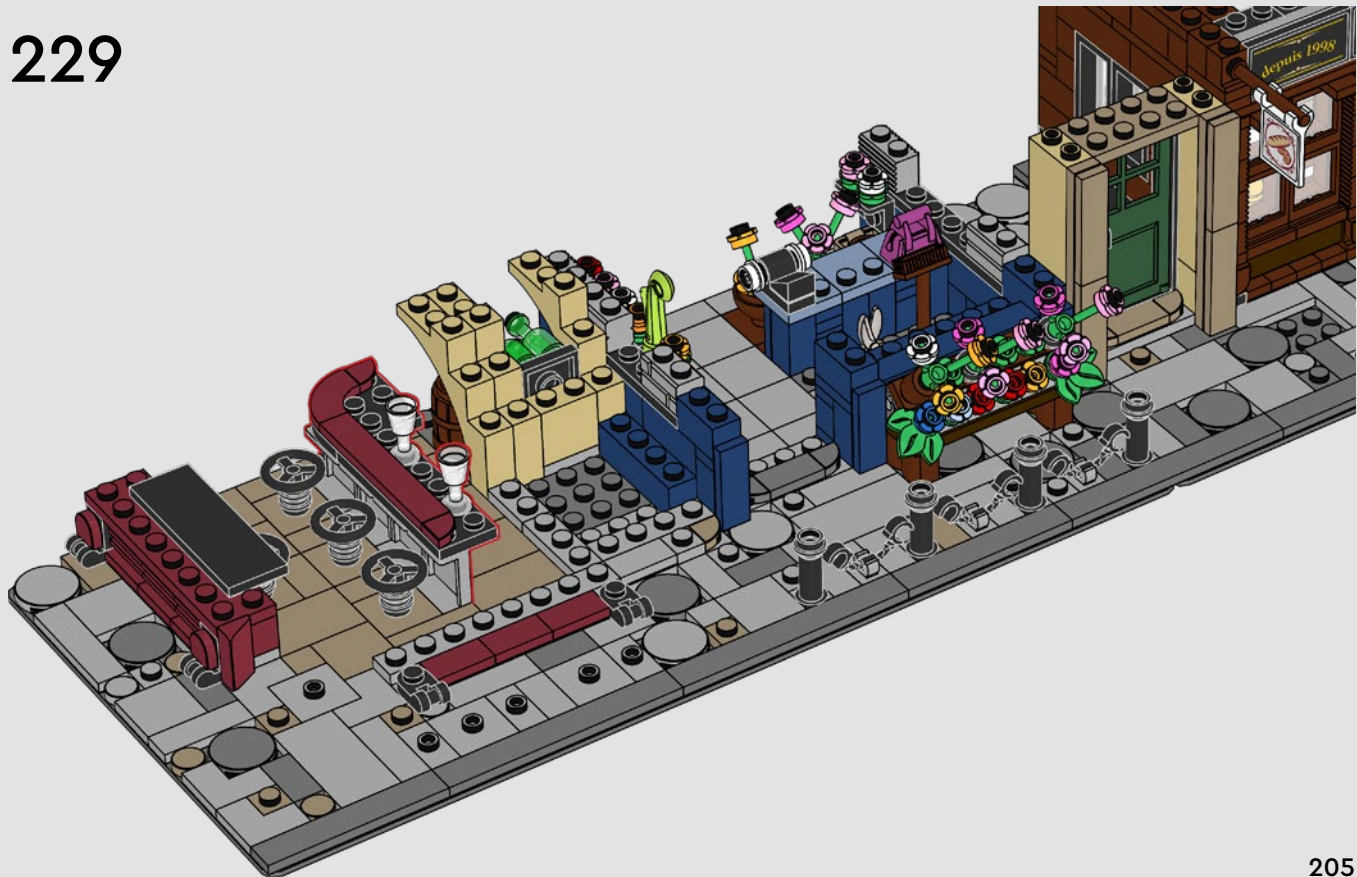

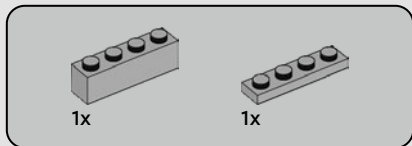

230



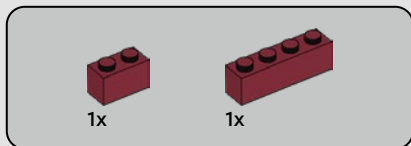

231



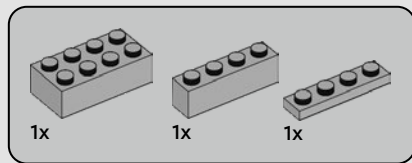

232





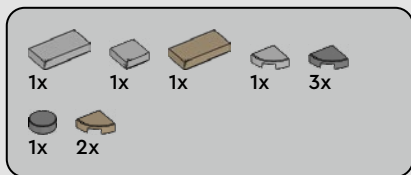

233





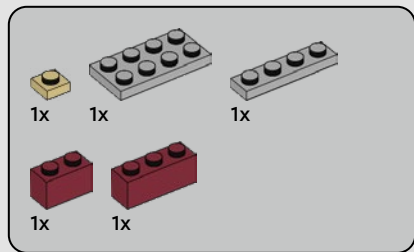

234



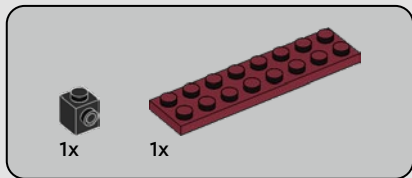
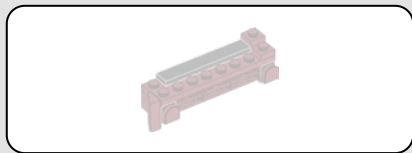

235

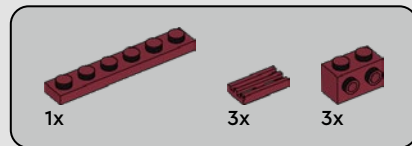
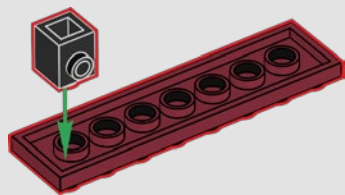

236

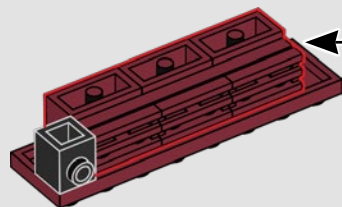
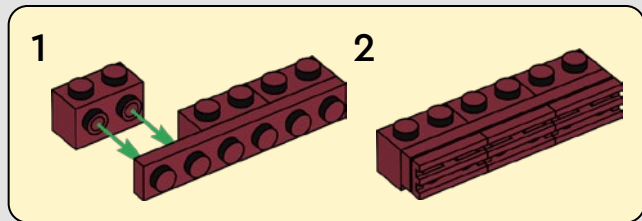



1x



1x



# 237

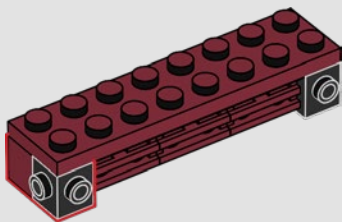

1x



1x



1x



1x



2x

# 238

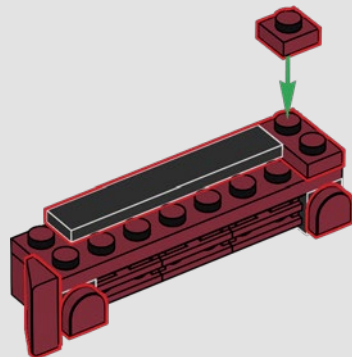

239

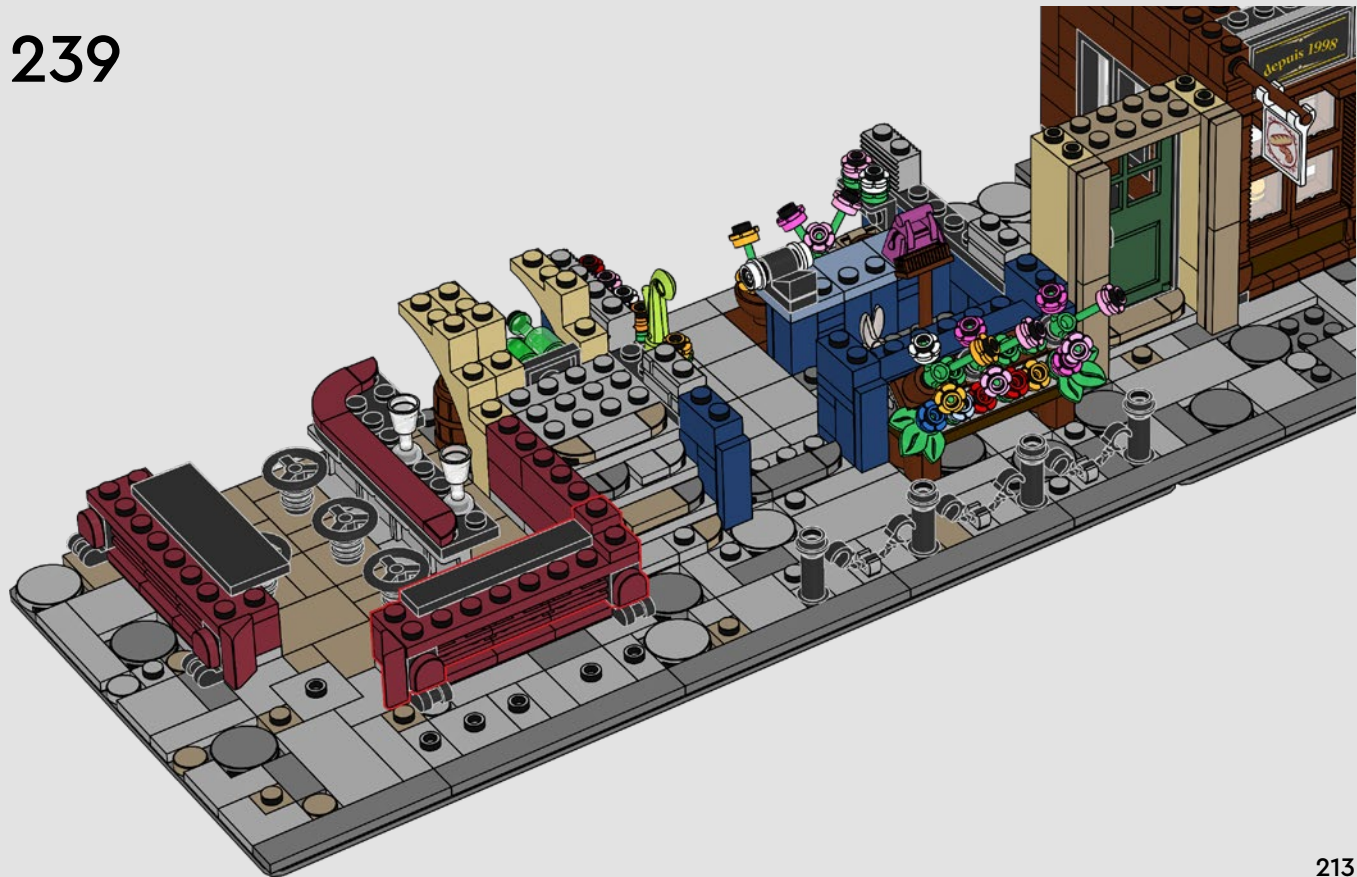



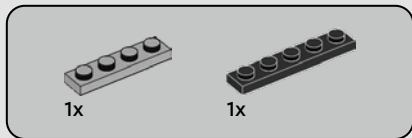

240

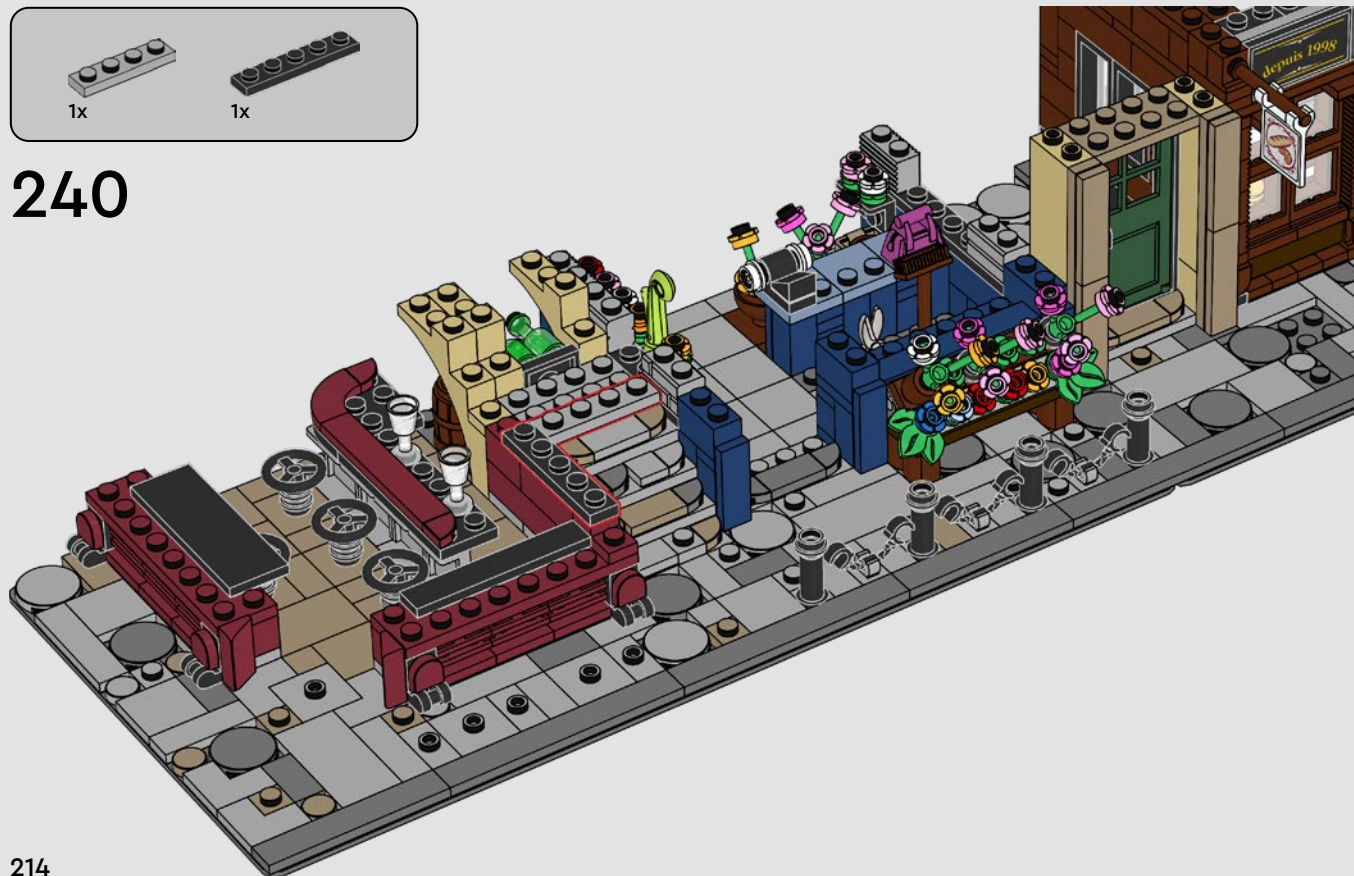



3x



3x

# 241

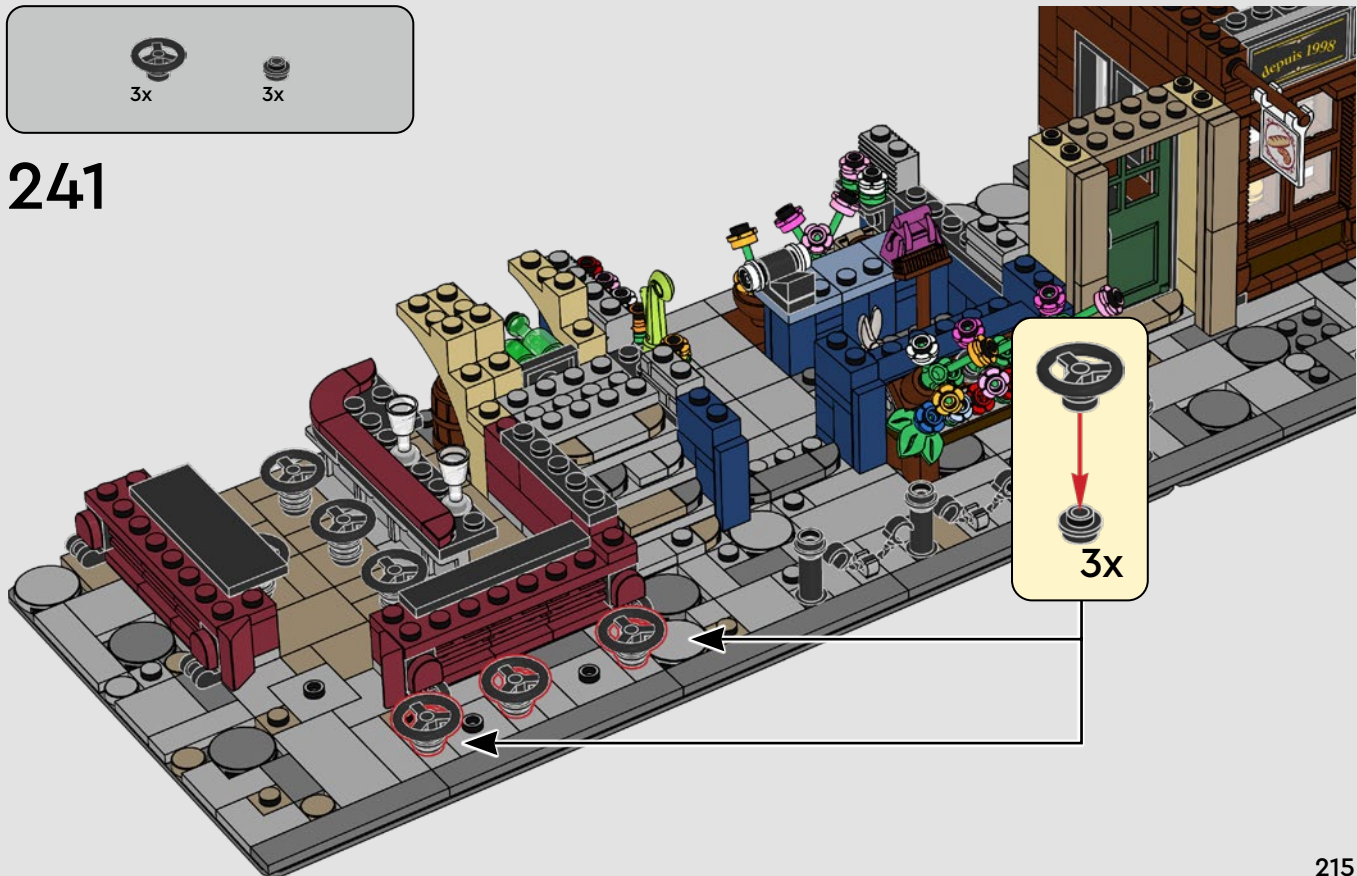

3x

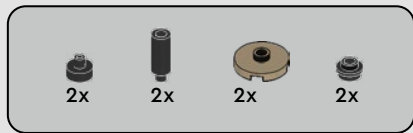

242

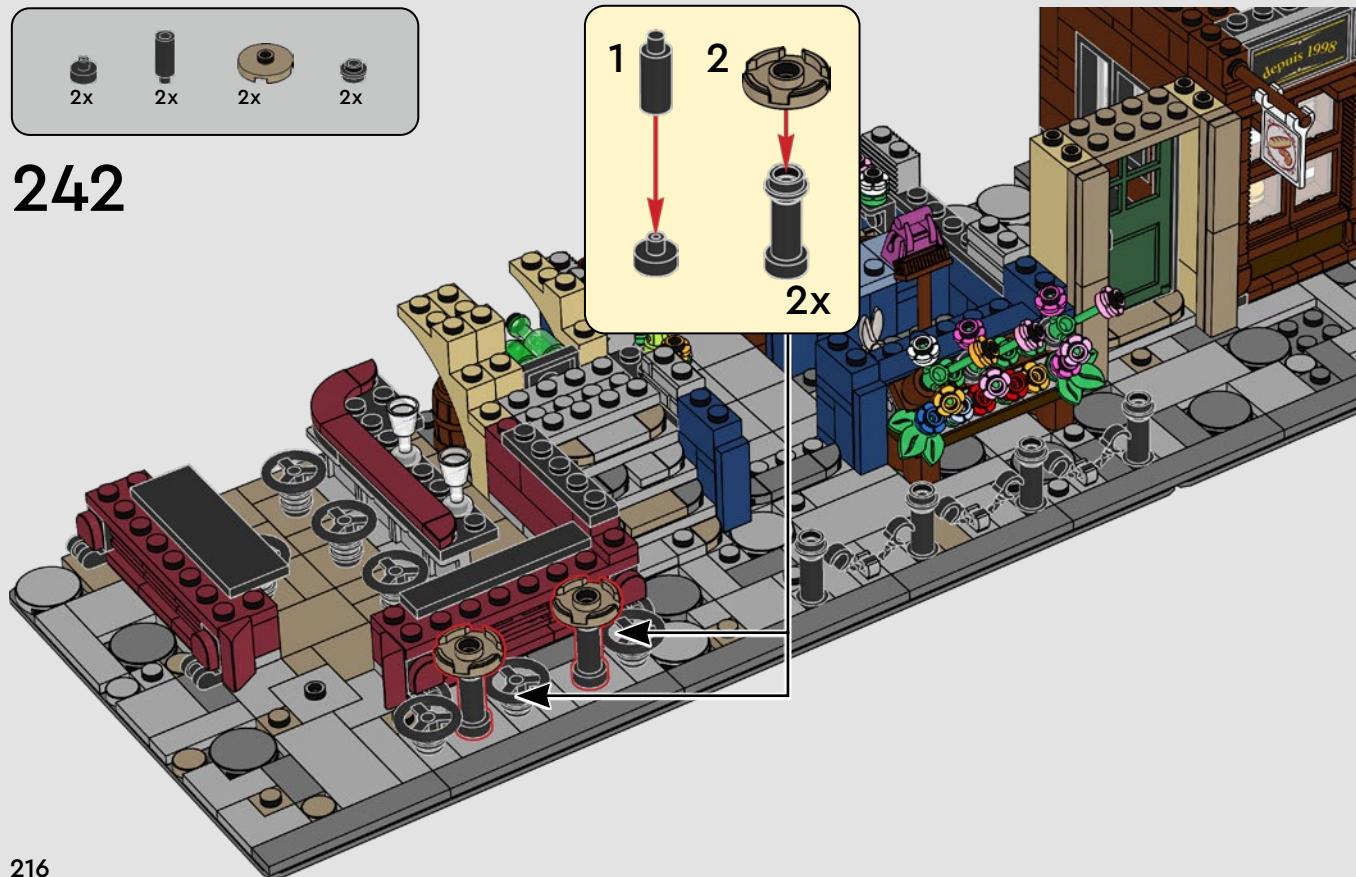
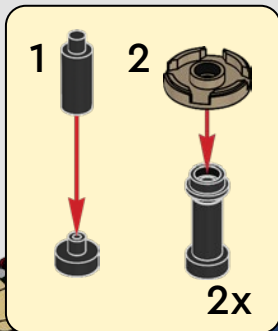



1x



1x

# 243

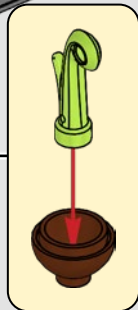
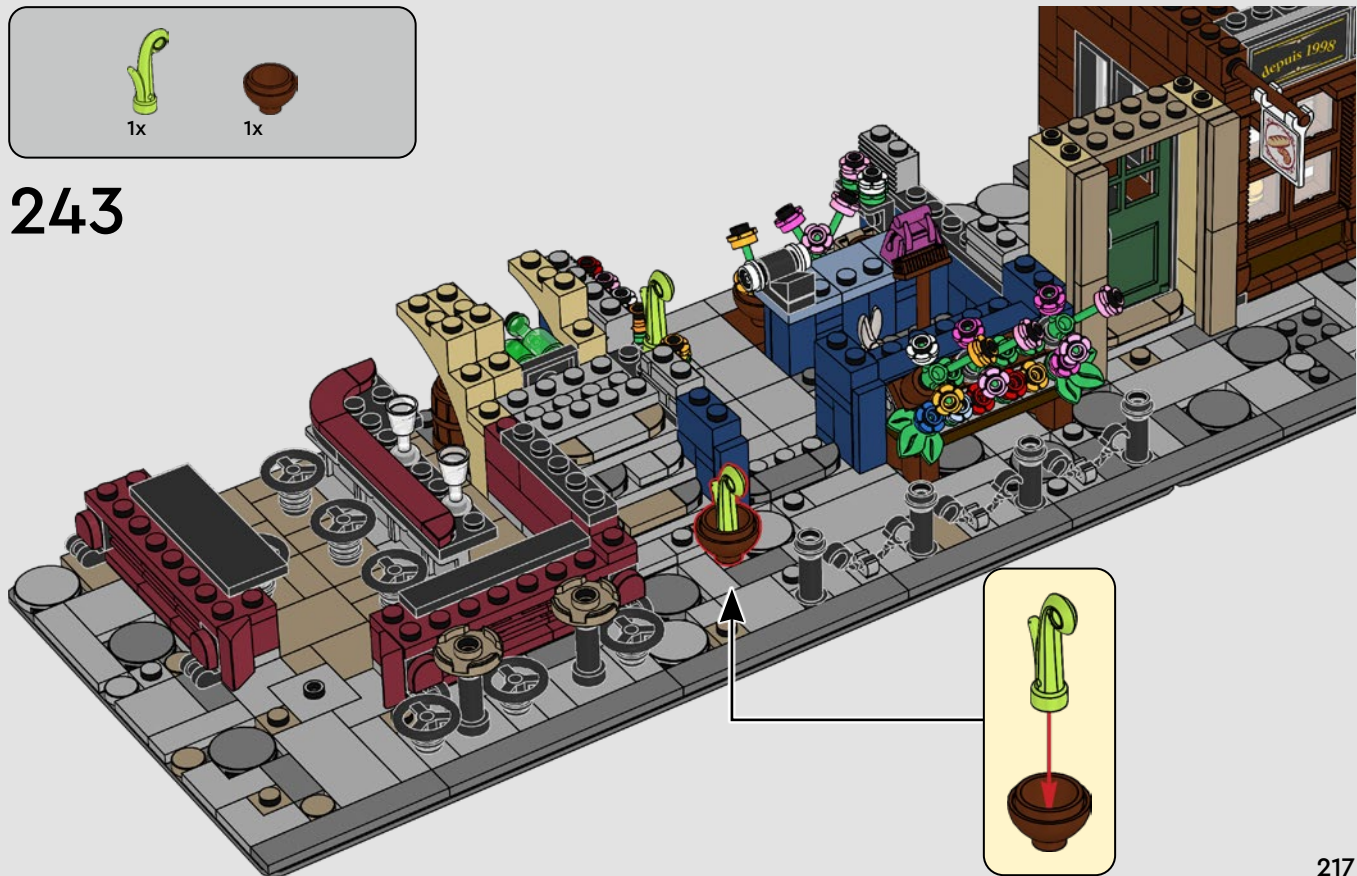



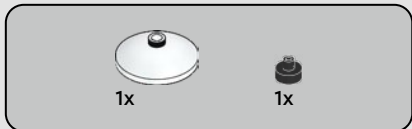

244



245

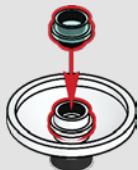

246

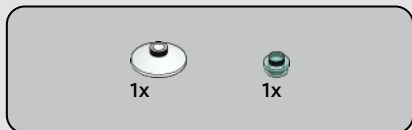
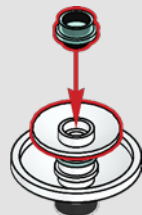

247

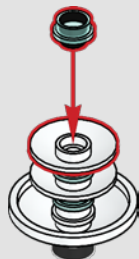

248



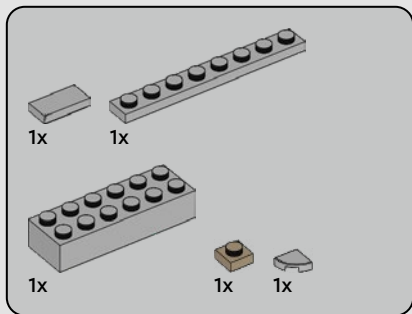

249

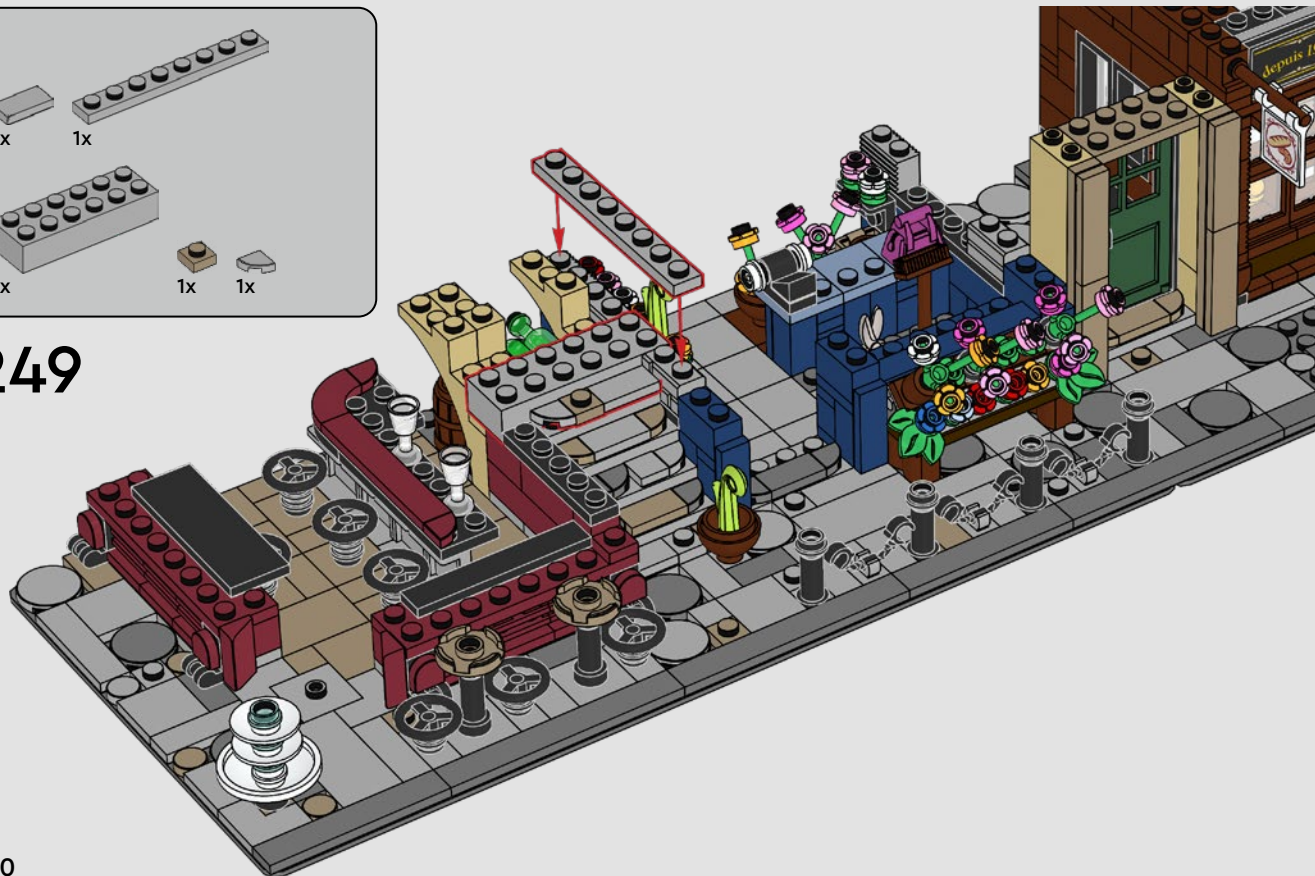

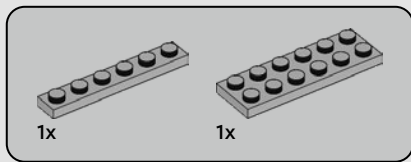

250





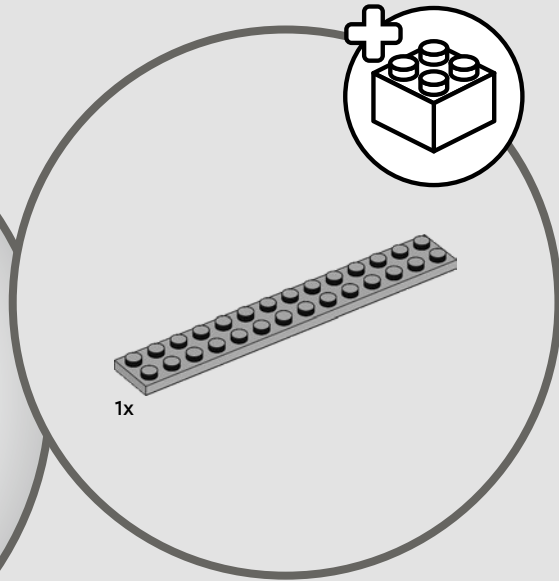



1x



1x



1x

# 251





1x



1x

# 252



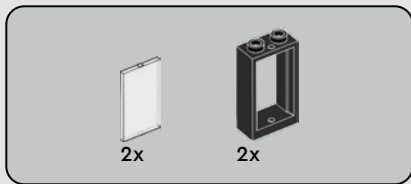

253

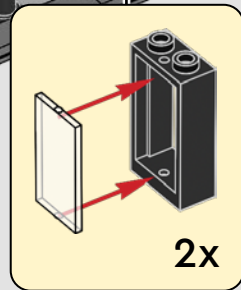
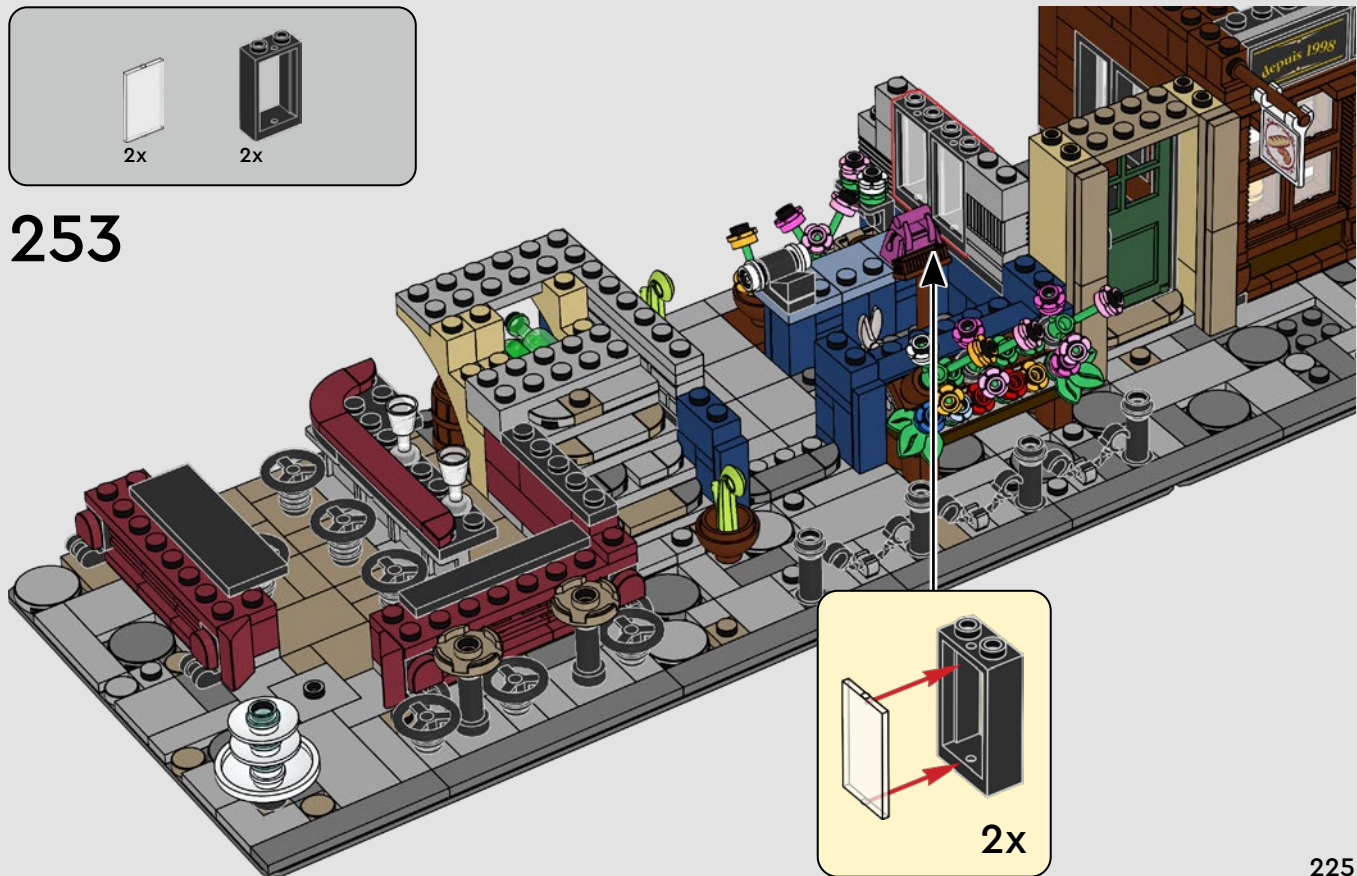



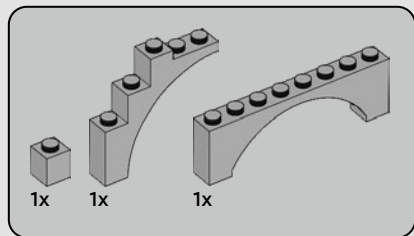

254



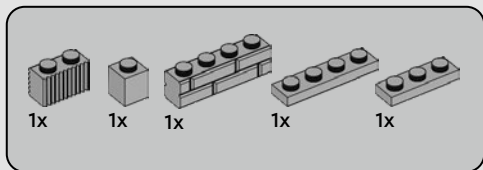

255





1x



3x

# 256







1x



1x

# 257





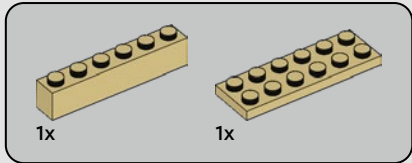
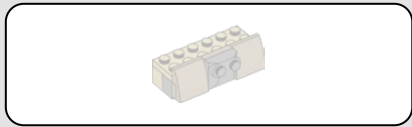

258

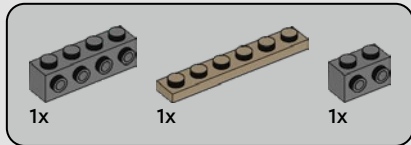
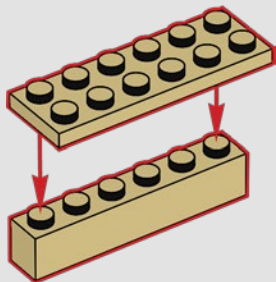

259

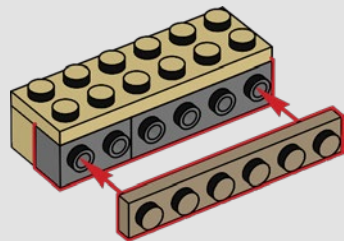

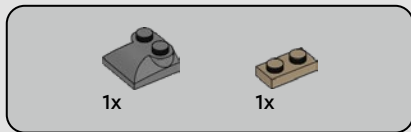

260

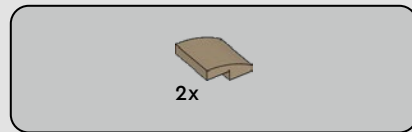
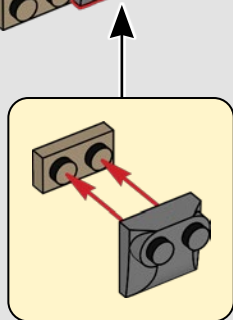
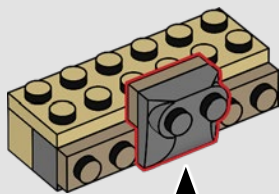

261

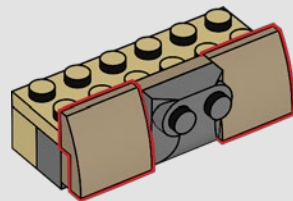

262



232

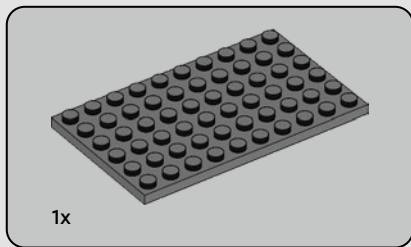

263







1x



1x

# 264

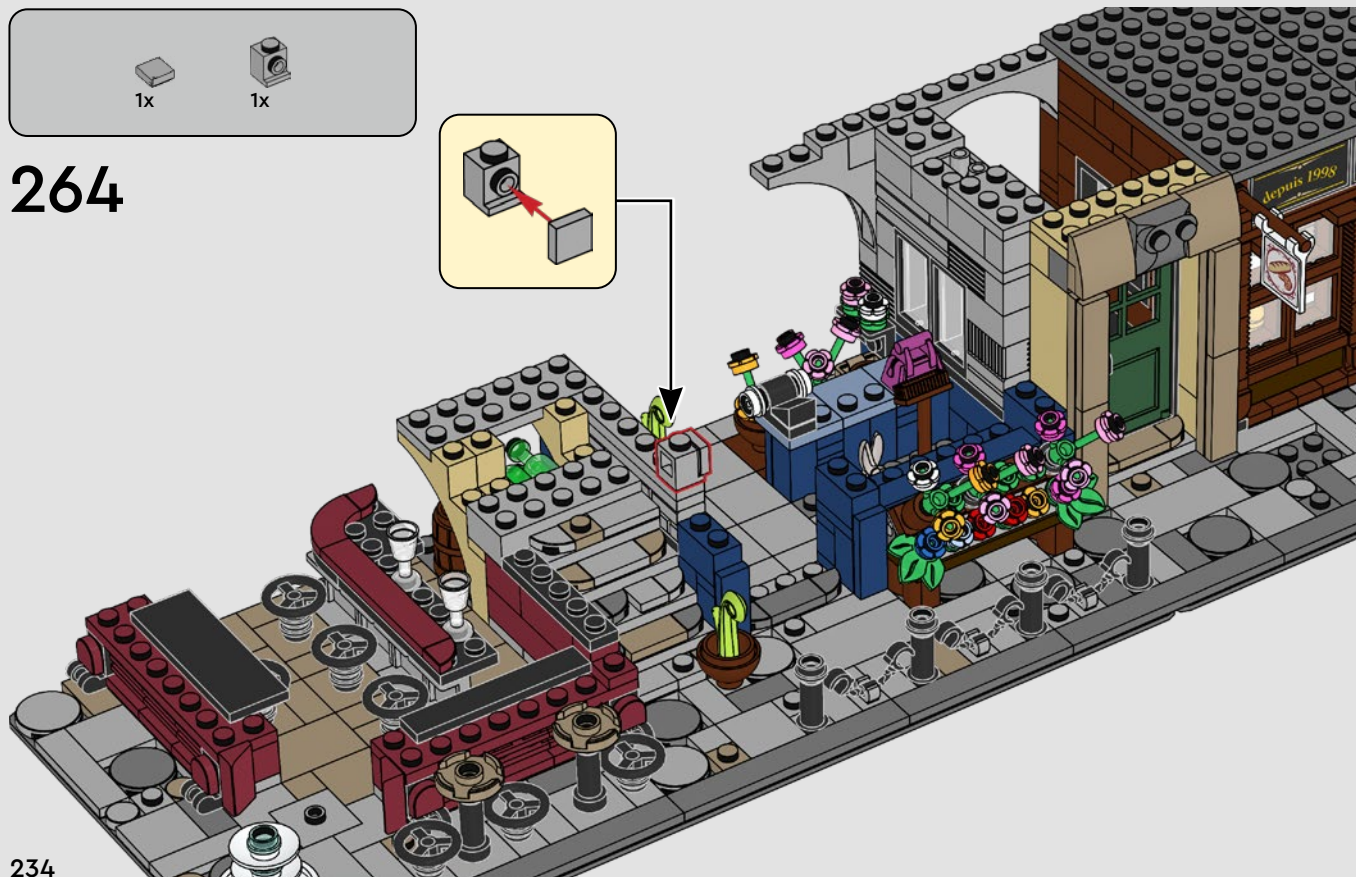
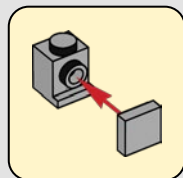

234

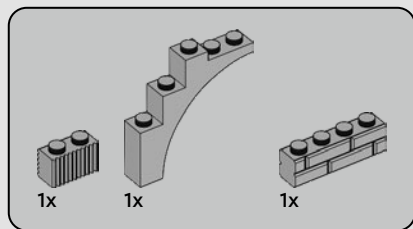

265

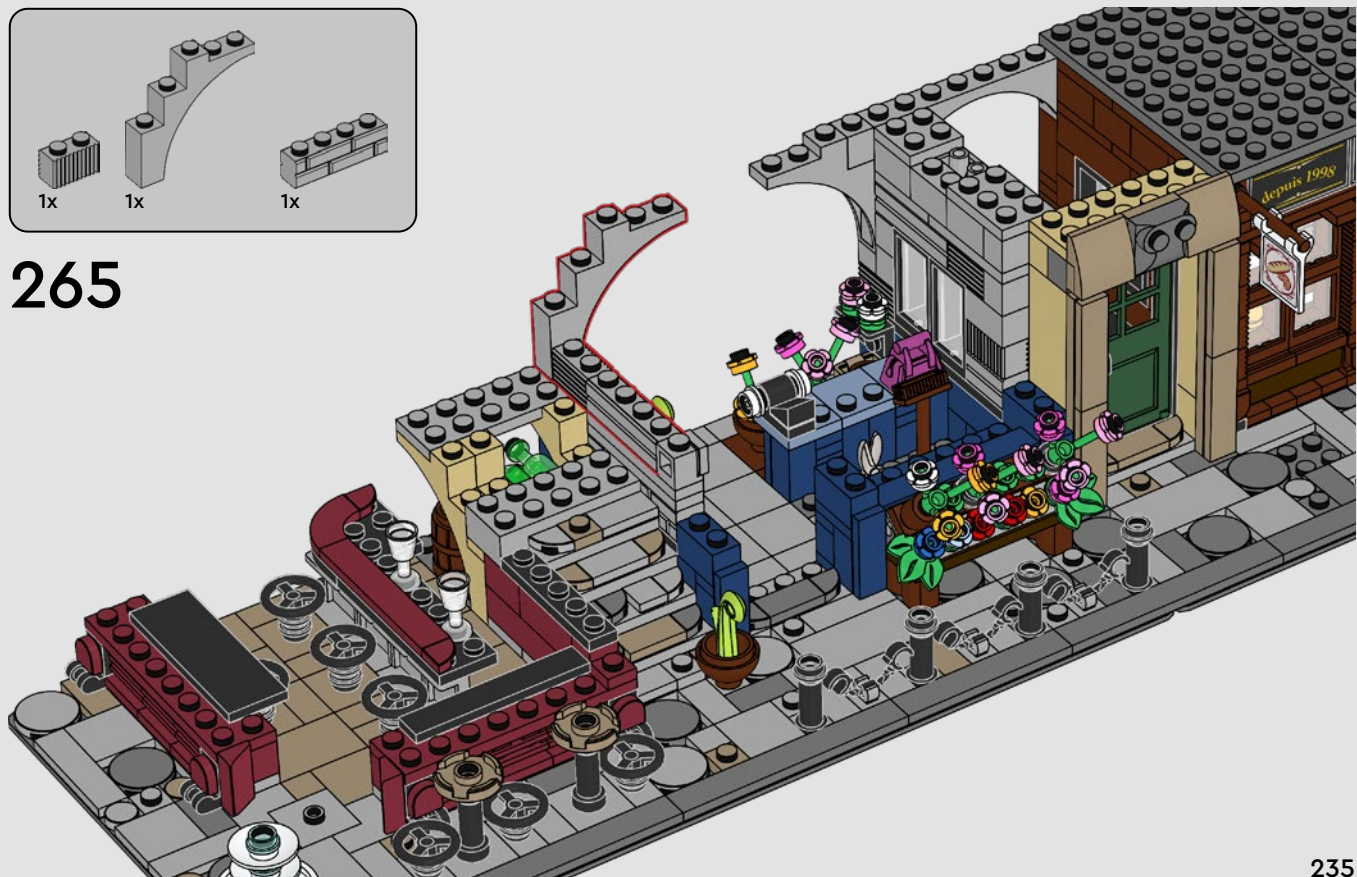

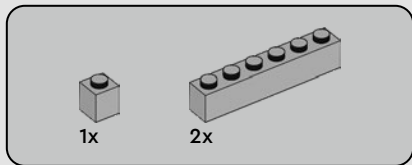

266



236





1x



1x

267

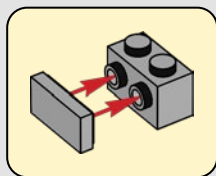





2x

268



238



2x



1x



1x

# 269



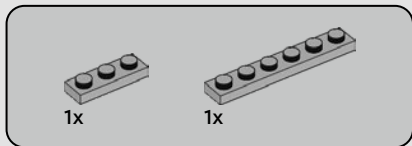

270

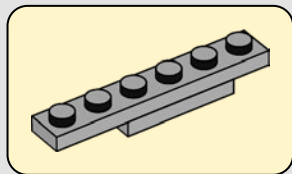

240



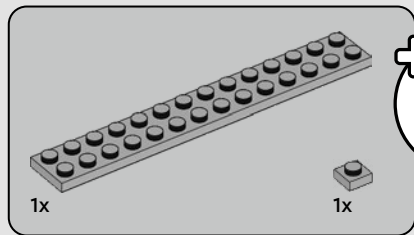

271





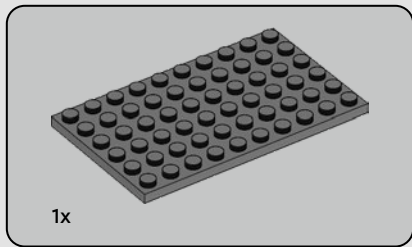

272

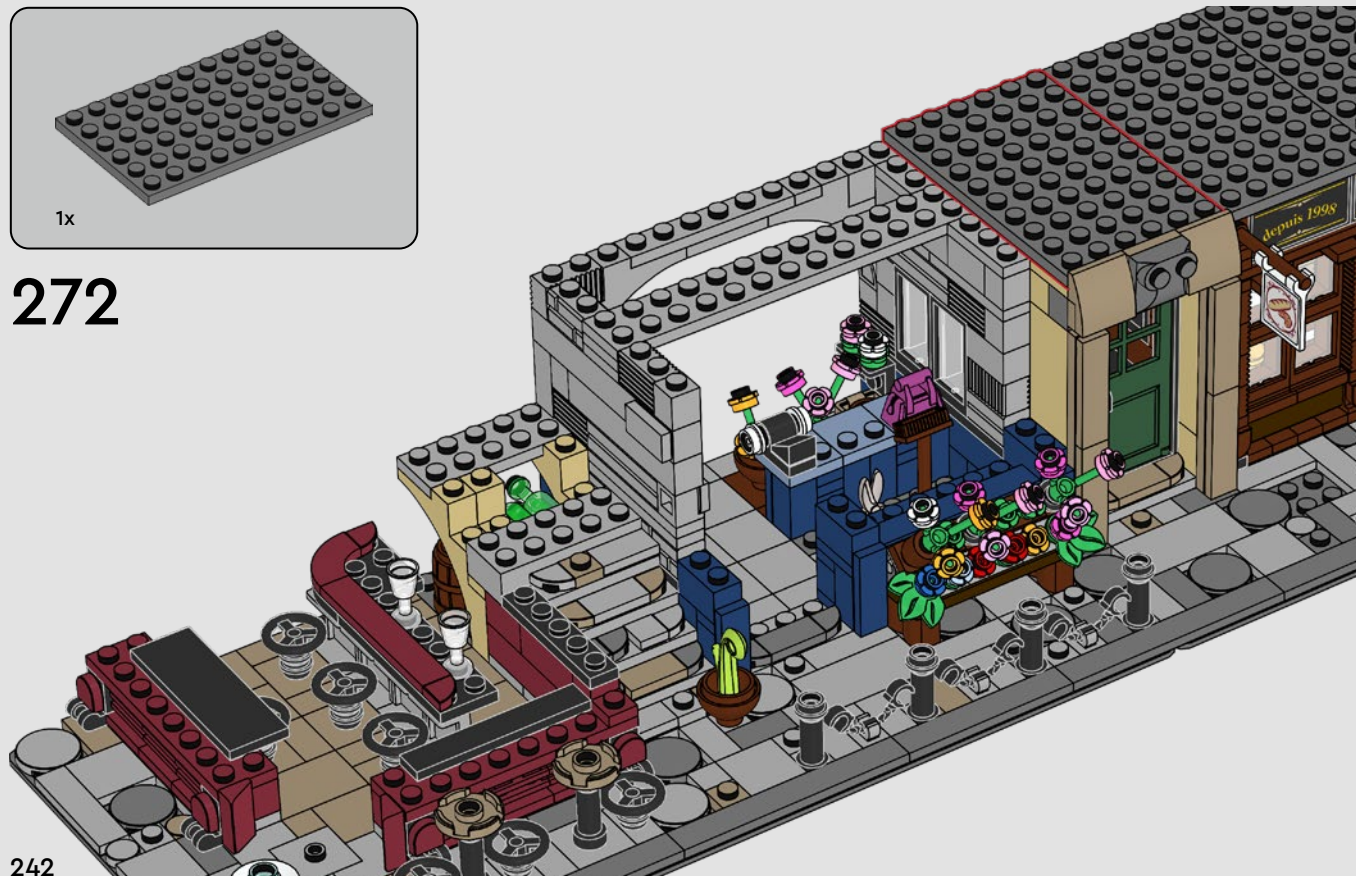

242



15x

273

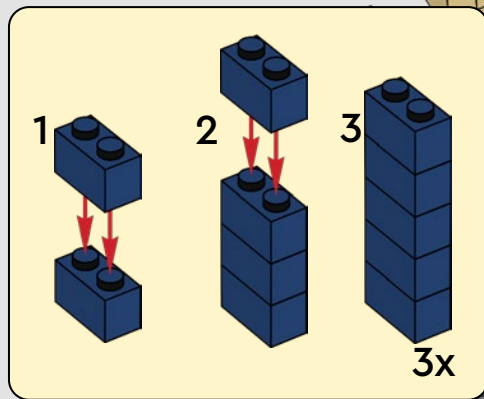

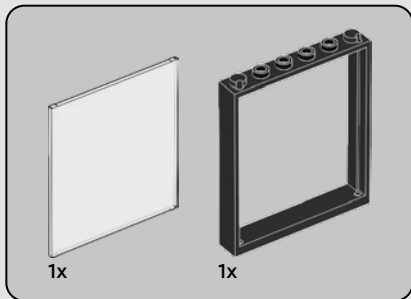

274

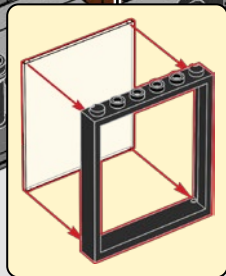

244

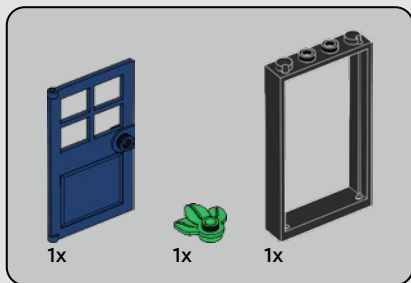

275

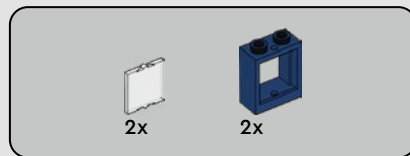

276

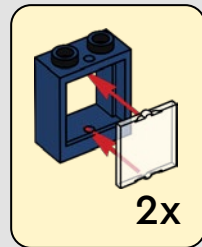



277



246

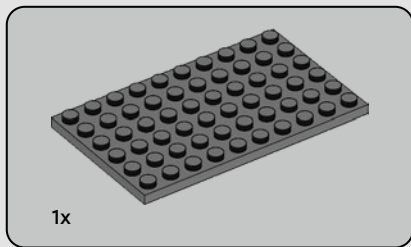

278



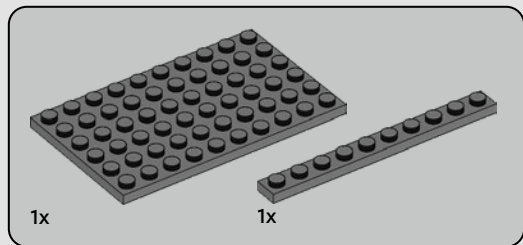

279



248



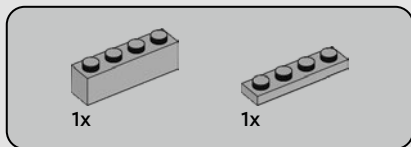

280





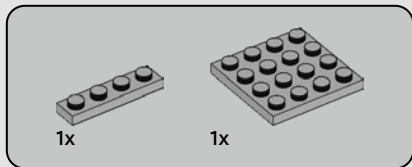

281



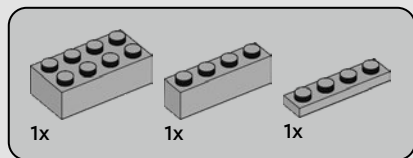

282



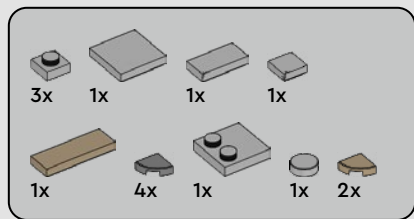

283







1x

284





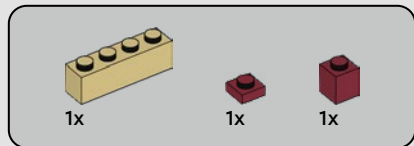

285



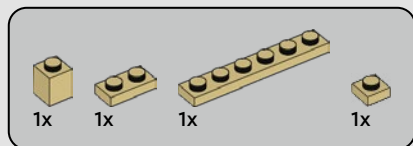

286



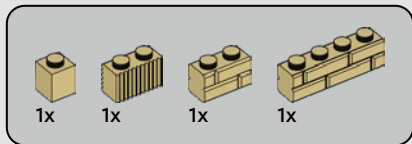

287





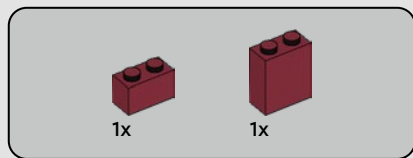

288





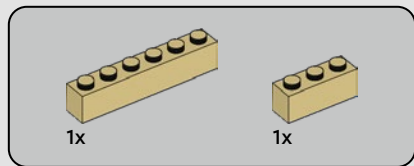

289



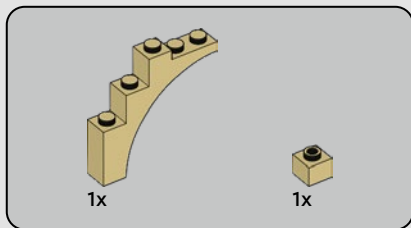

290

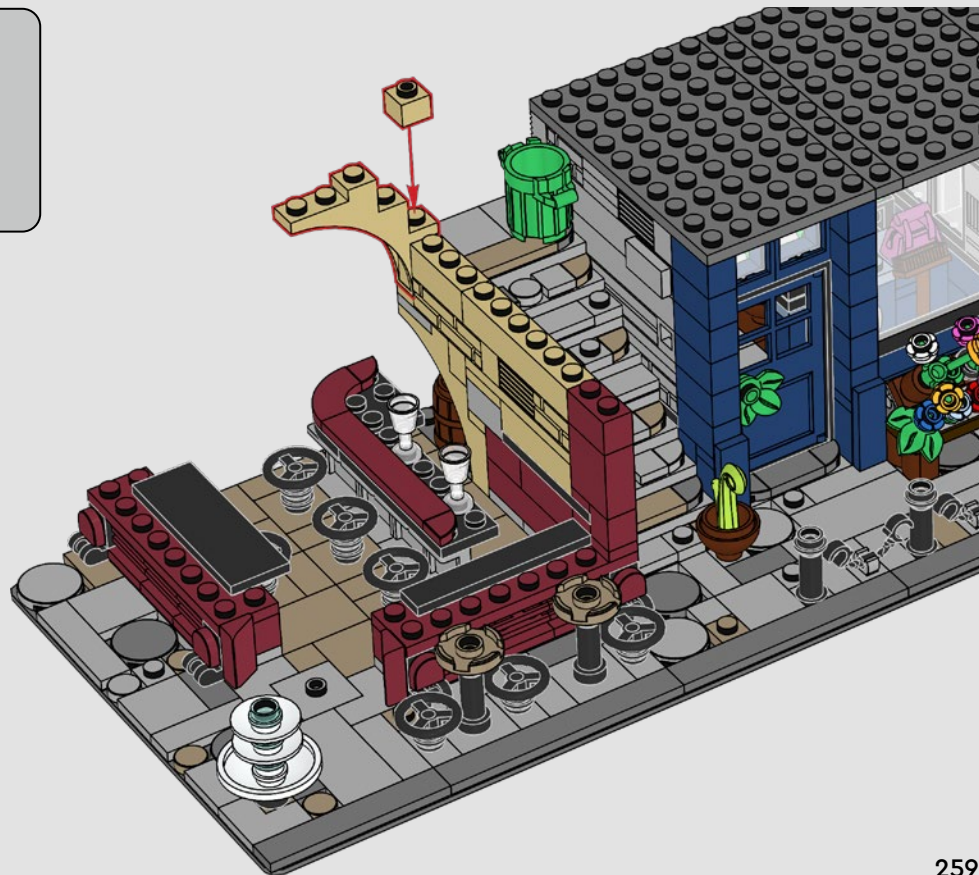

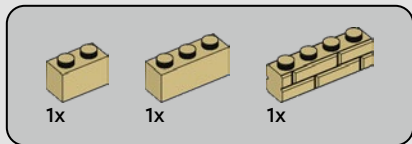

291

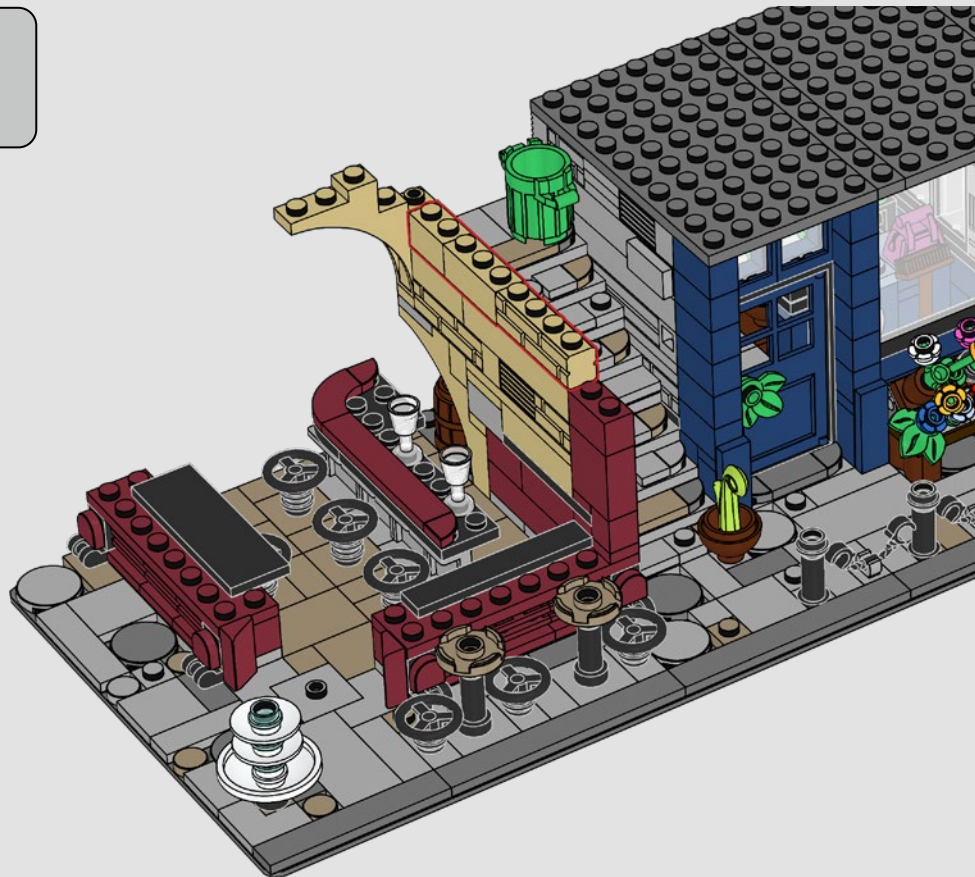

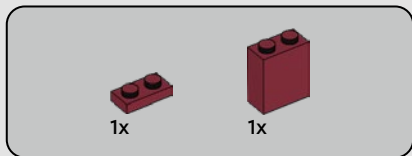
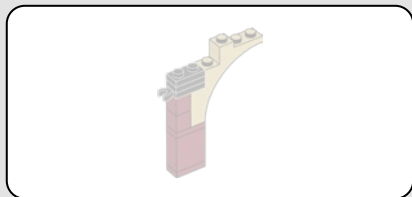

292

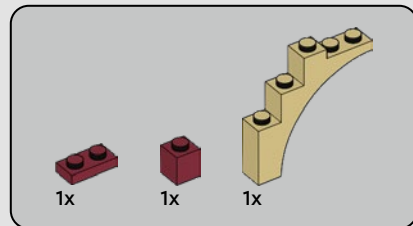
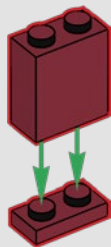

293

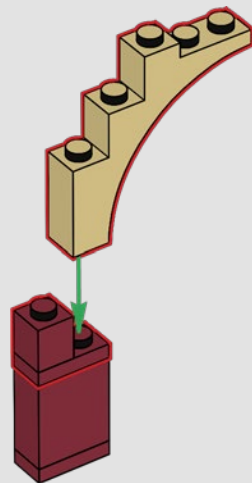





1x



1x

# 294

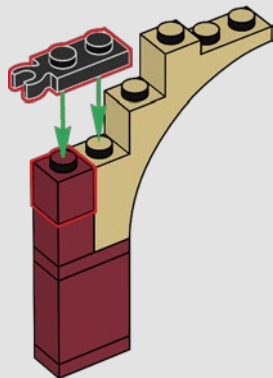

2x

# 295

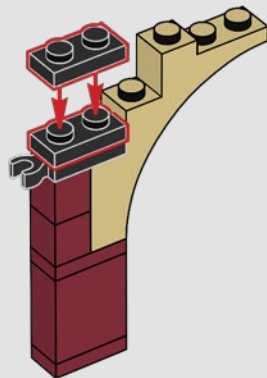

296



263

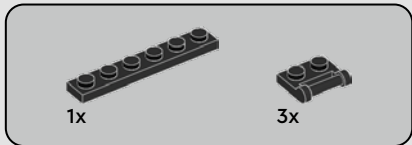
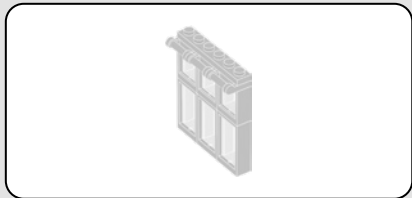

297

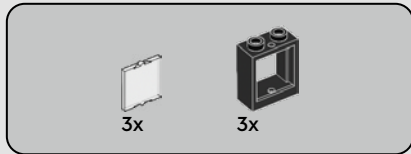
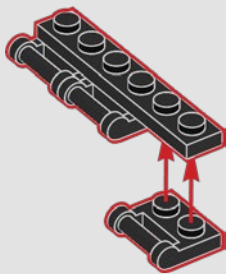

298

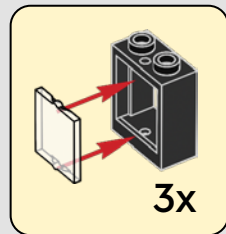
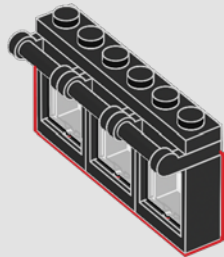

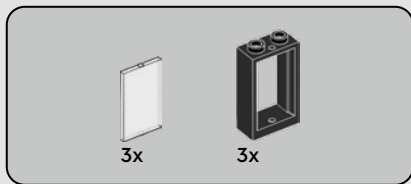

299

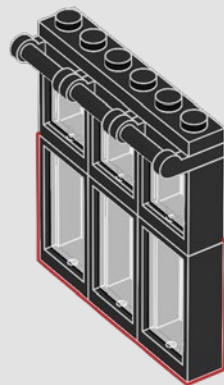
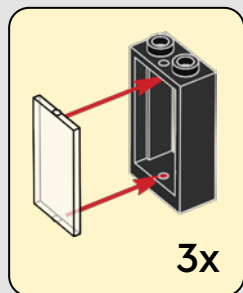



300



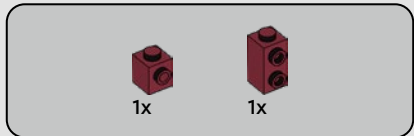
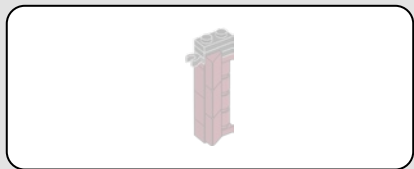

301

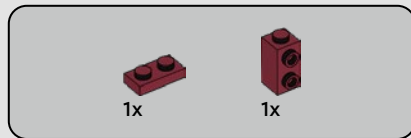
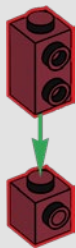

302

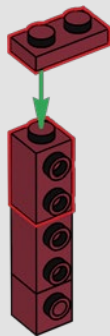



4x



1x

# 303



1

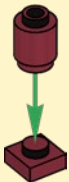

2



3



1x



1x

# 304

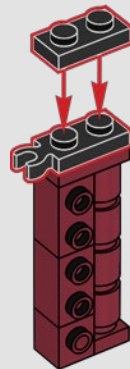



1x



3x

# 305





306



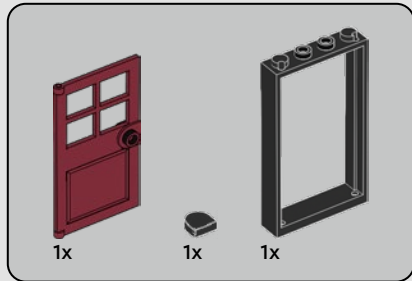
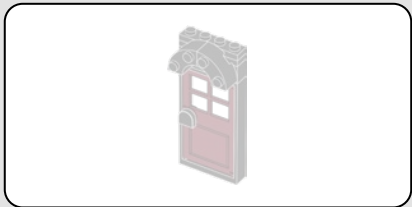

307



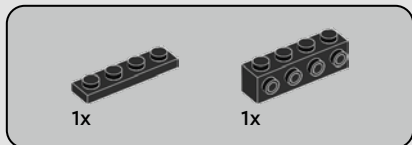

308

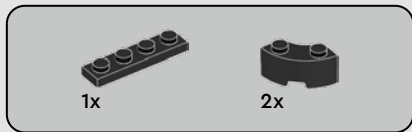
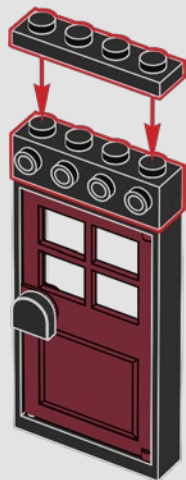

309

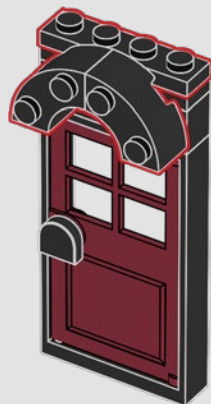

310





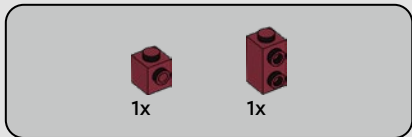
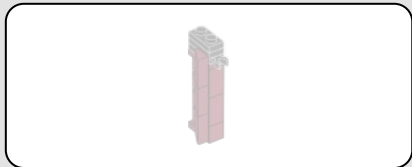

311

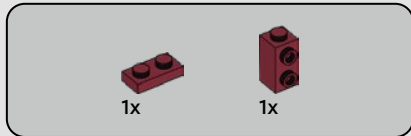
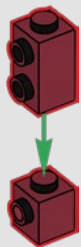

312

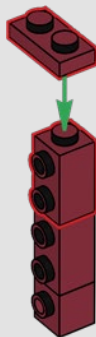



4x



1x

# 313

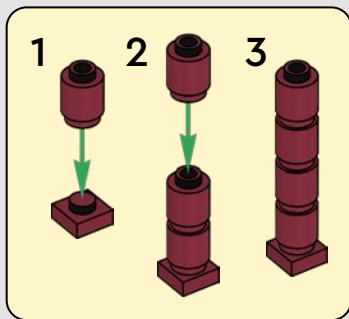



1x



1x

# 314

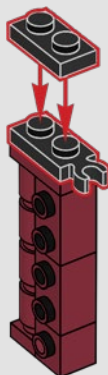

1x



3x

# 315



316





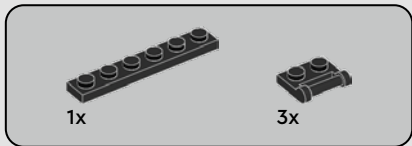
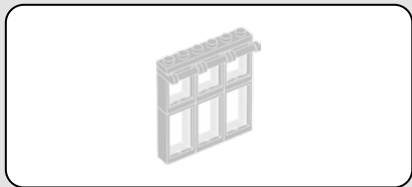

317

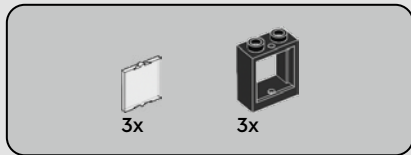
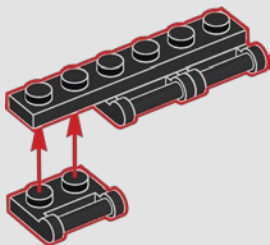

318

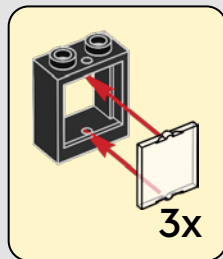
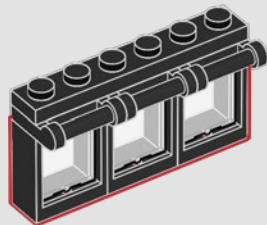

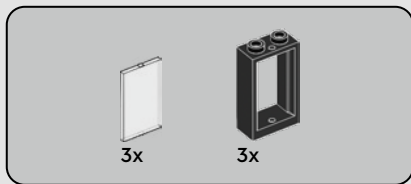

319

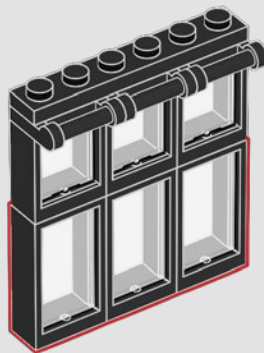
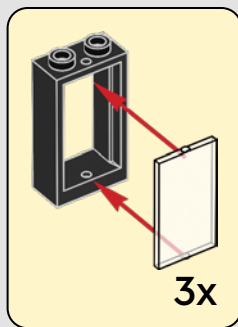

320



280



321





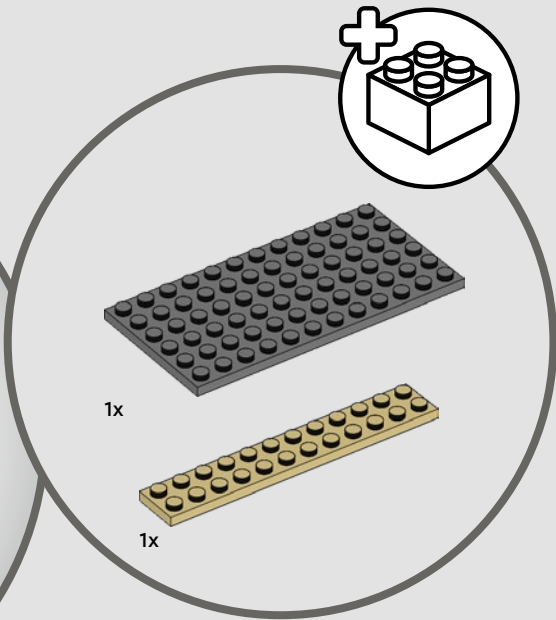

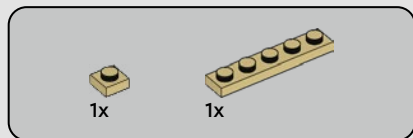

322

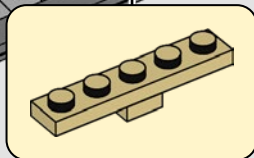

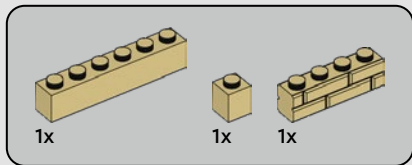

323

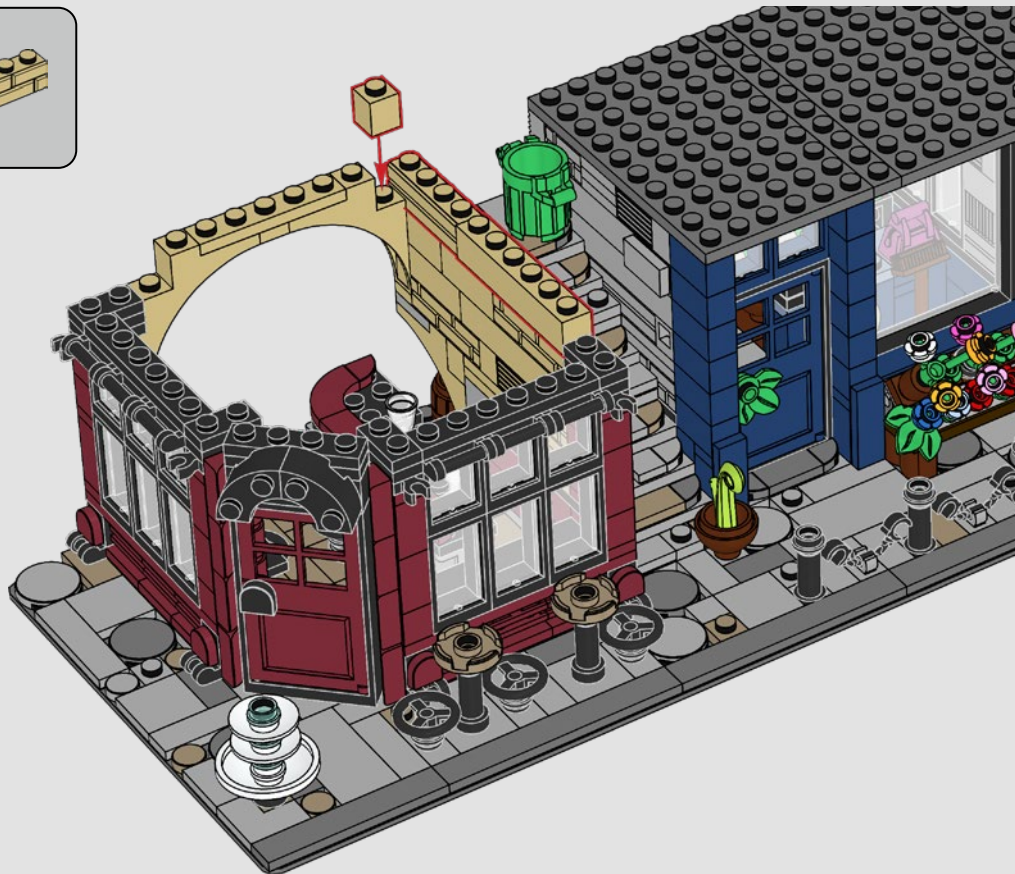

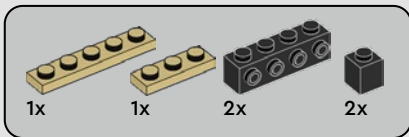

324

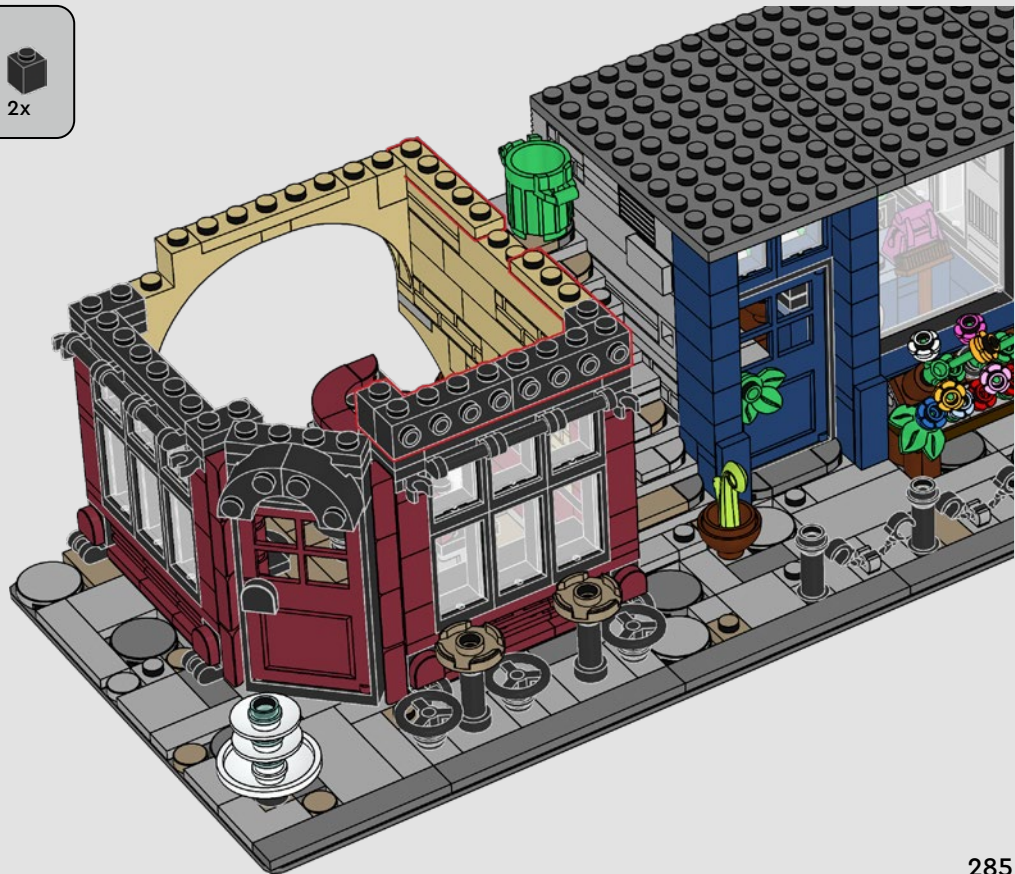



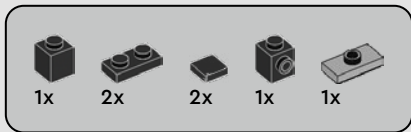

325



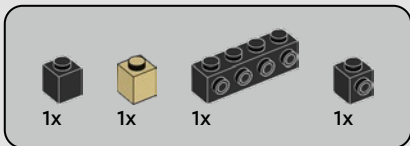

326

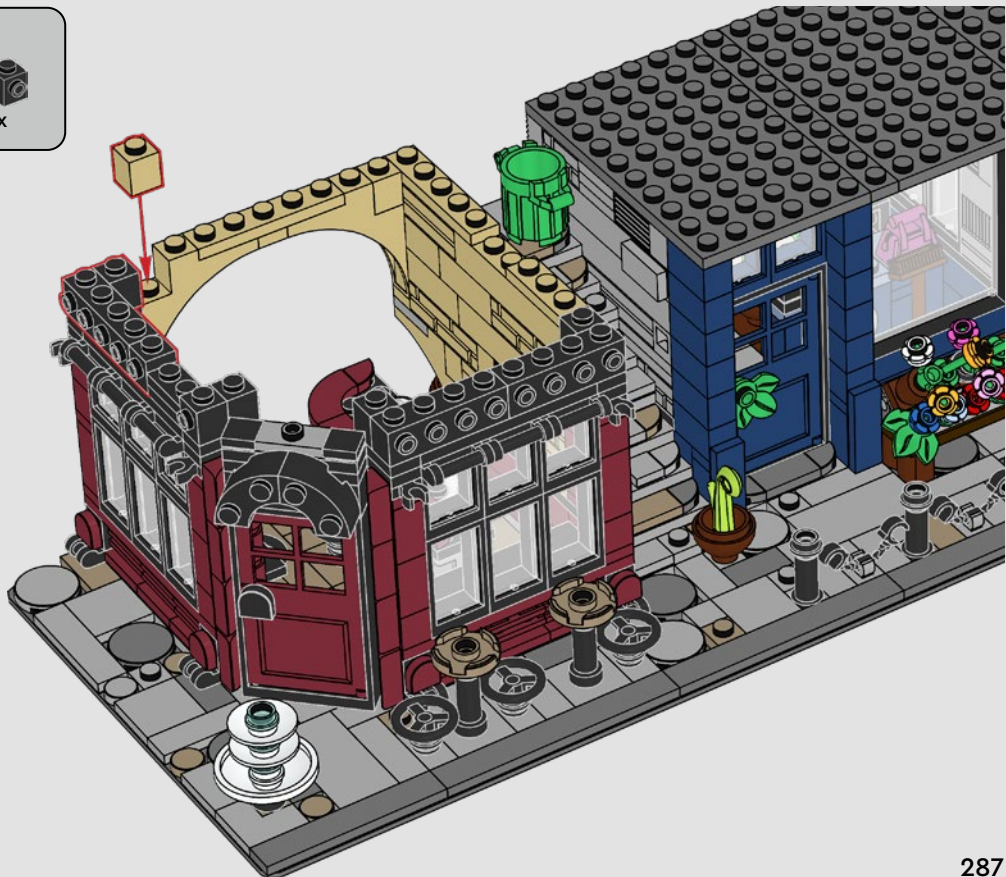



1x

327



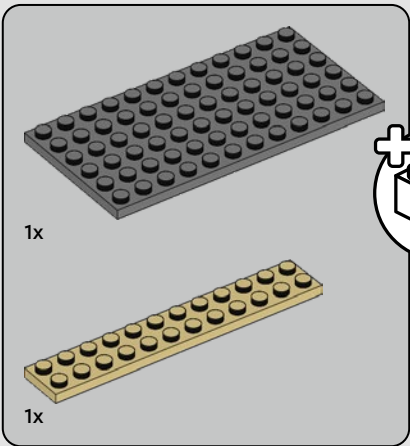
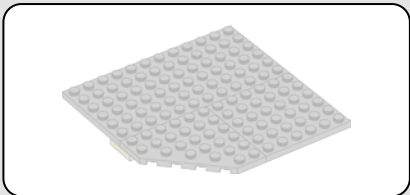

328

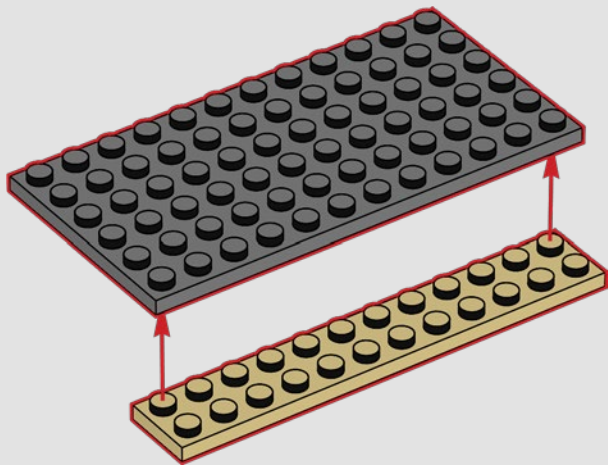



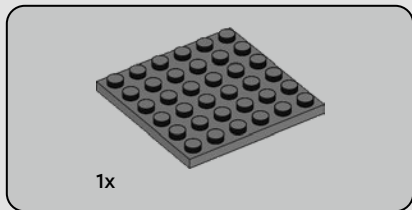

329

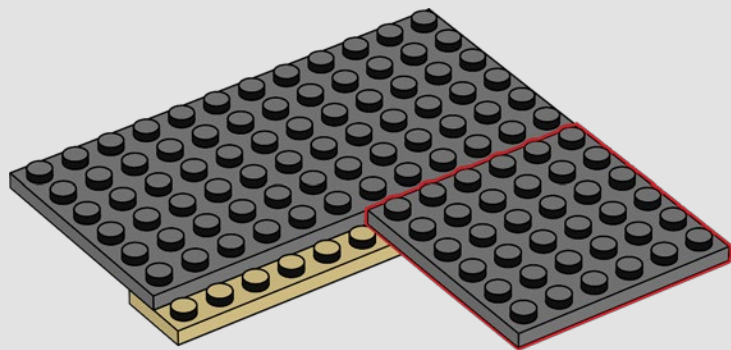

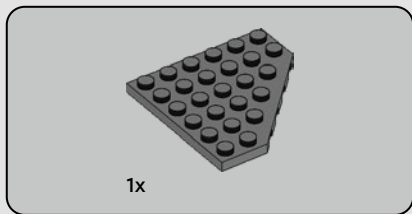

330

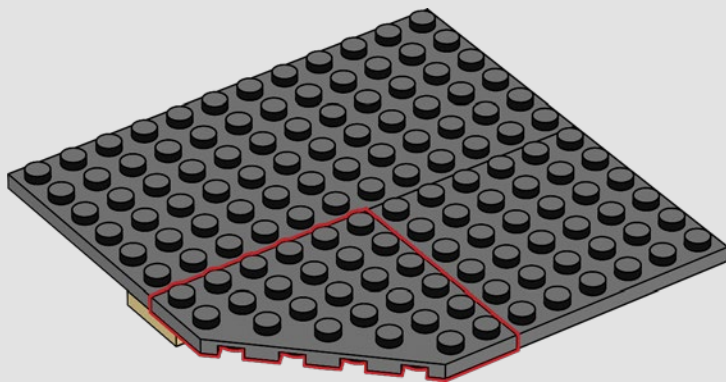

331



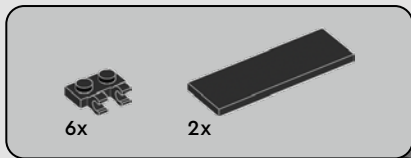

332

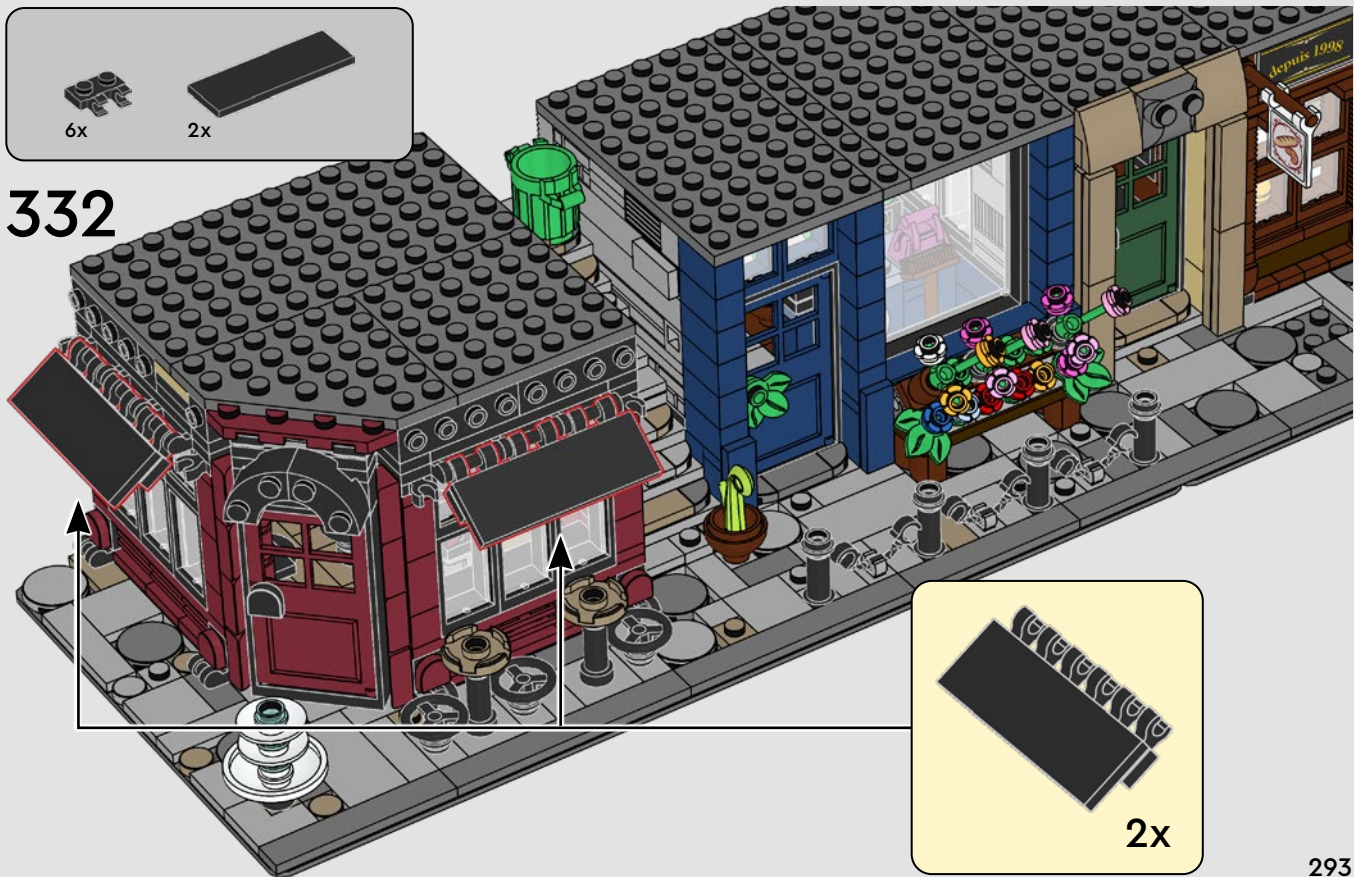



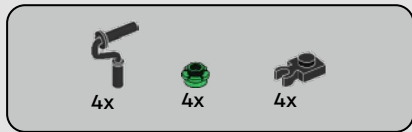

333

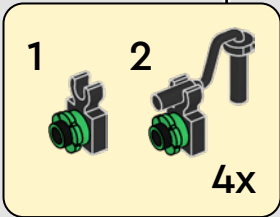
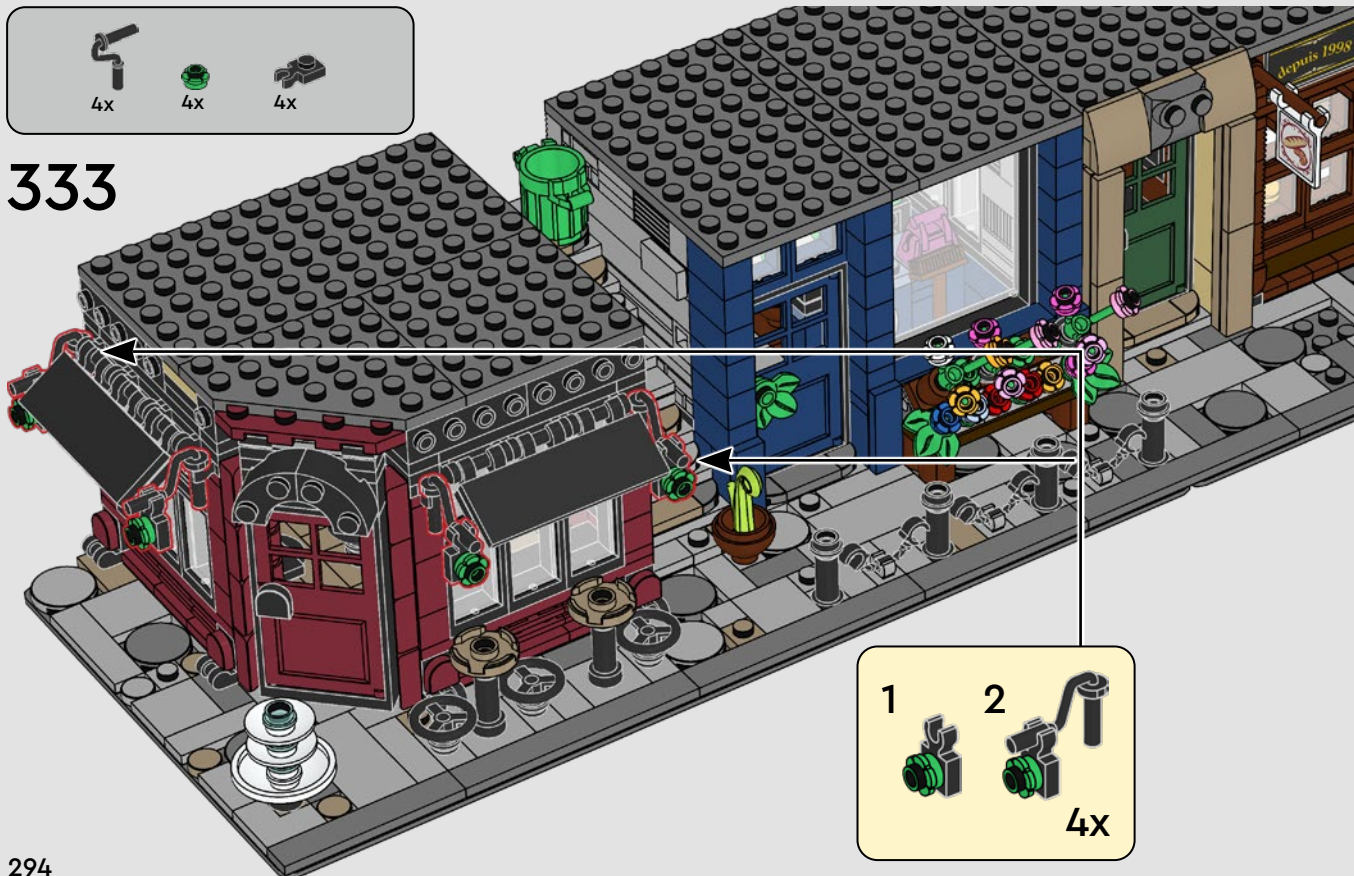

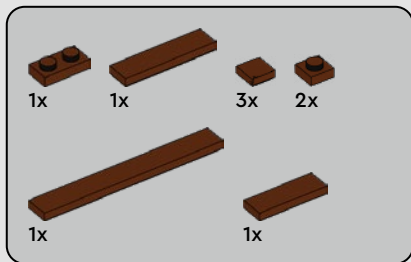

334



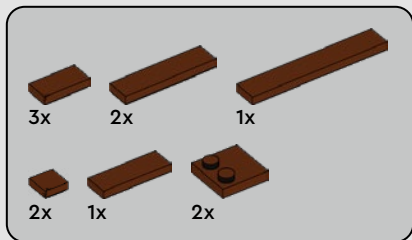

335





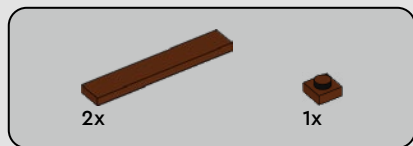

336





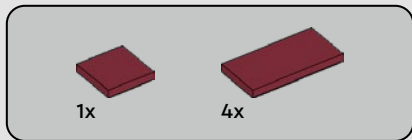

337





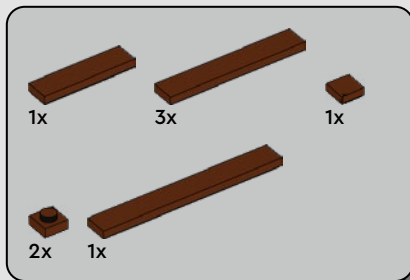

339

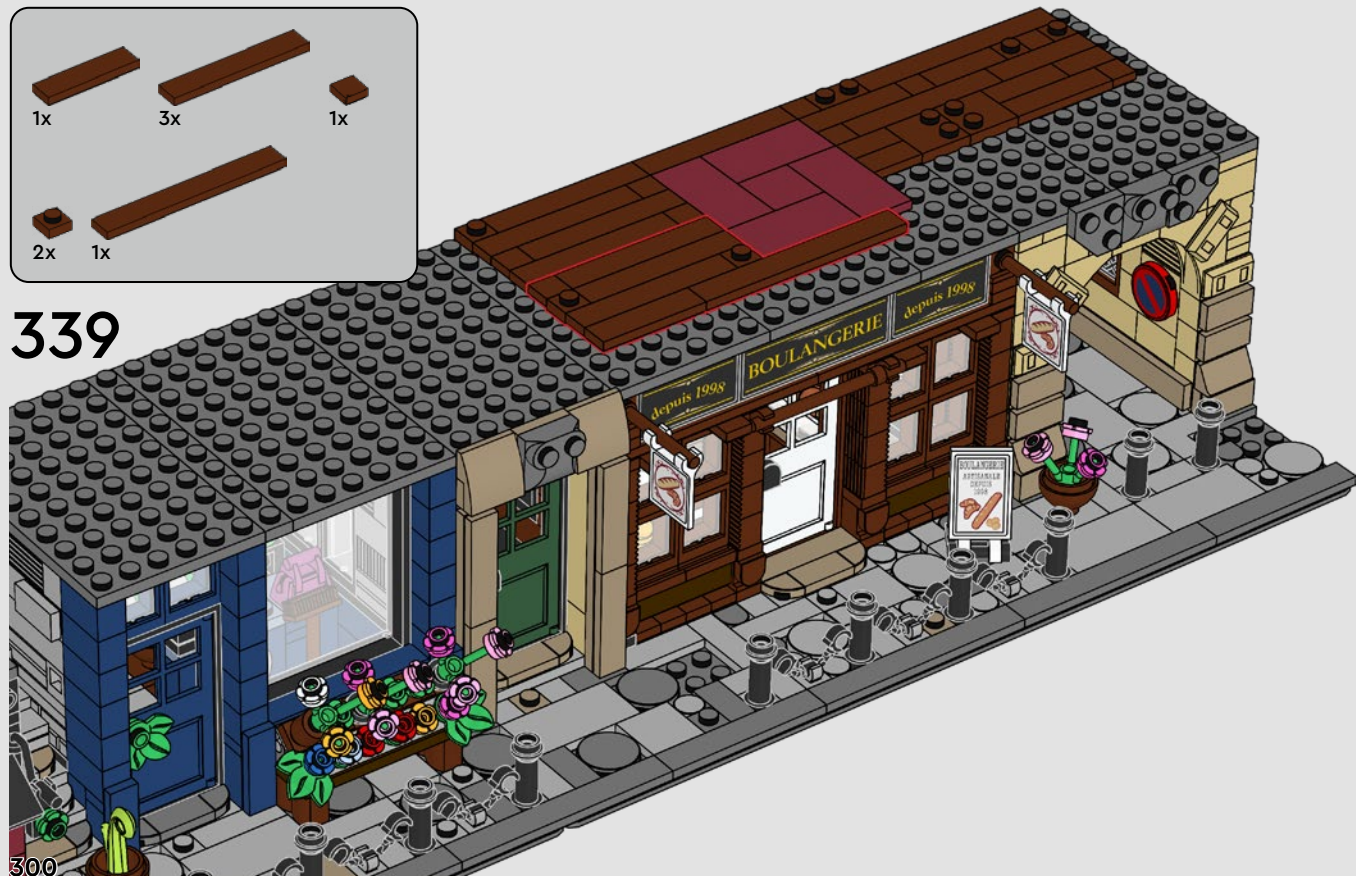

300



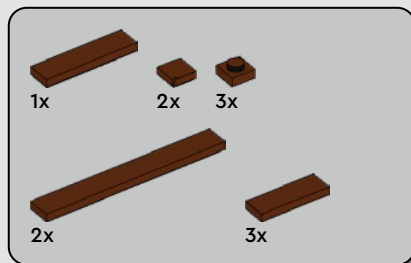

340





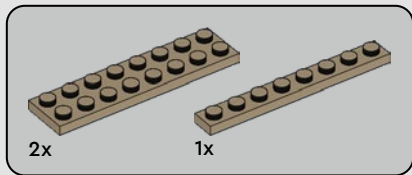

341

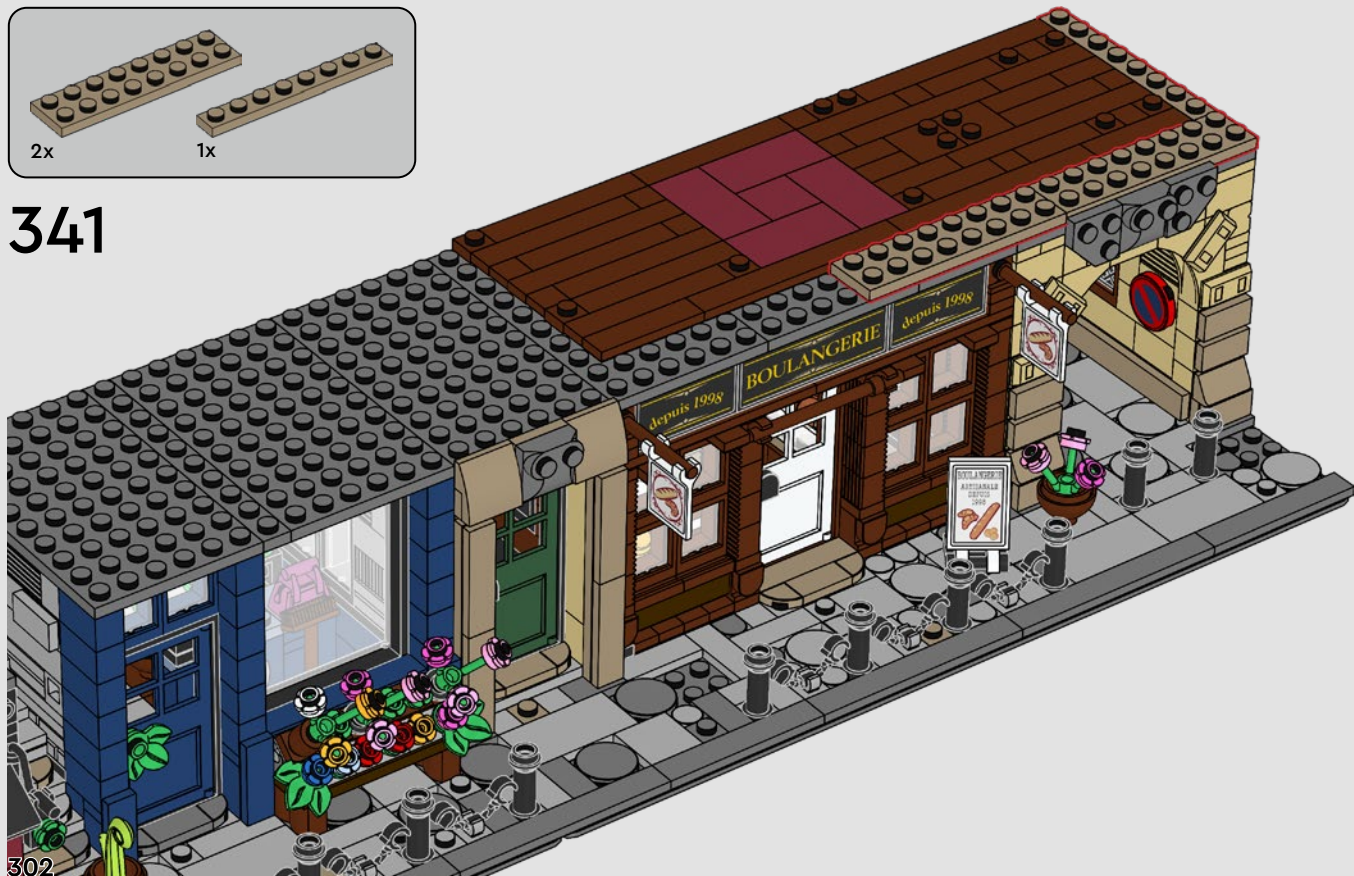

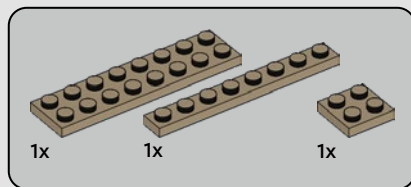

342

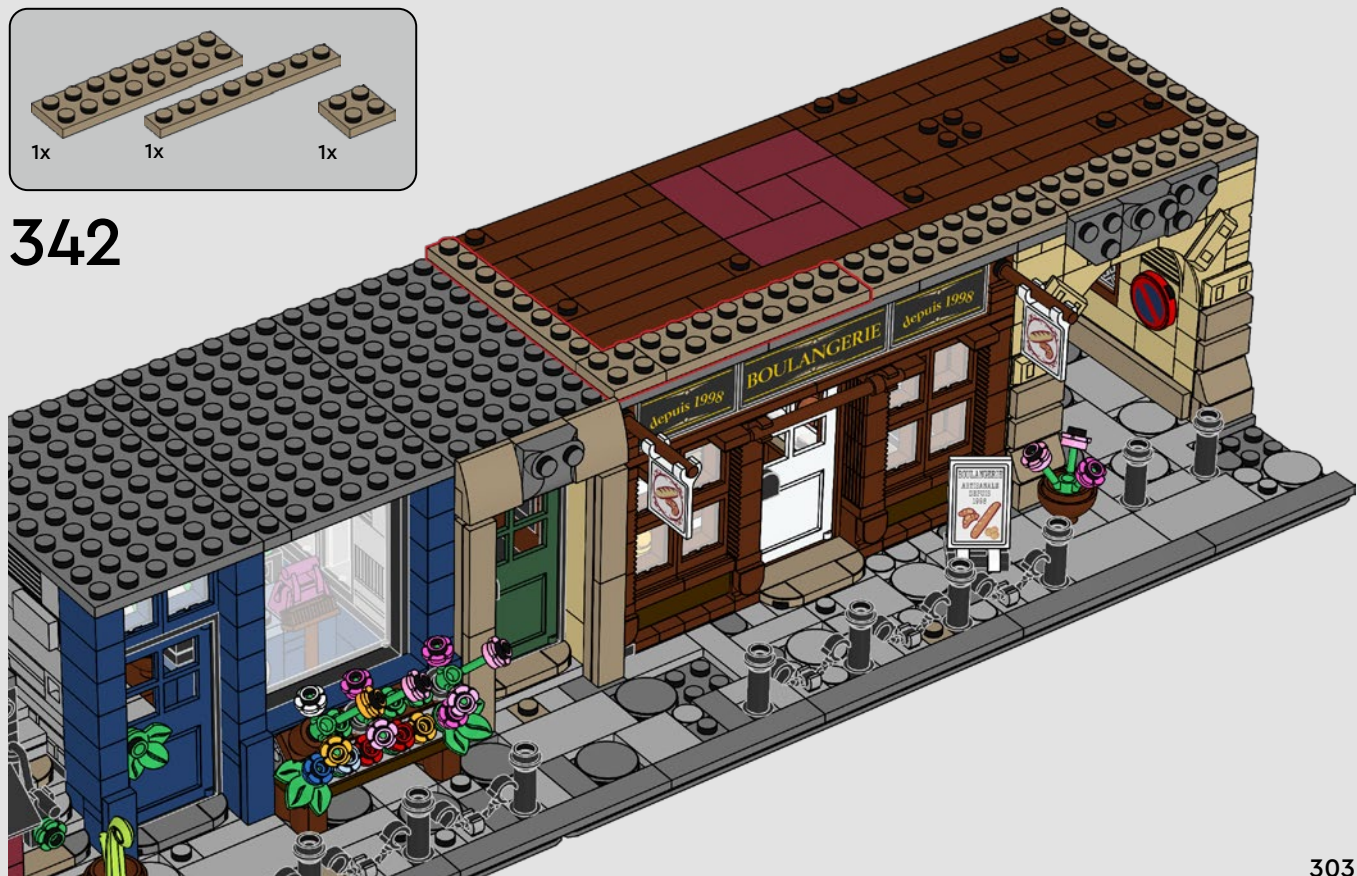







1x



2x

# 344





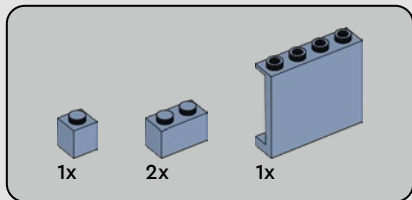

345

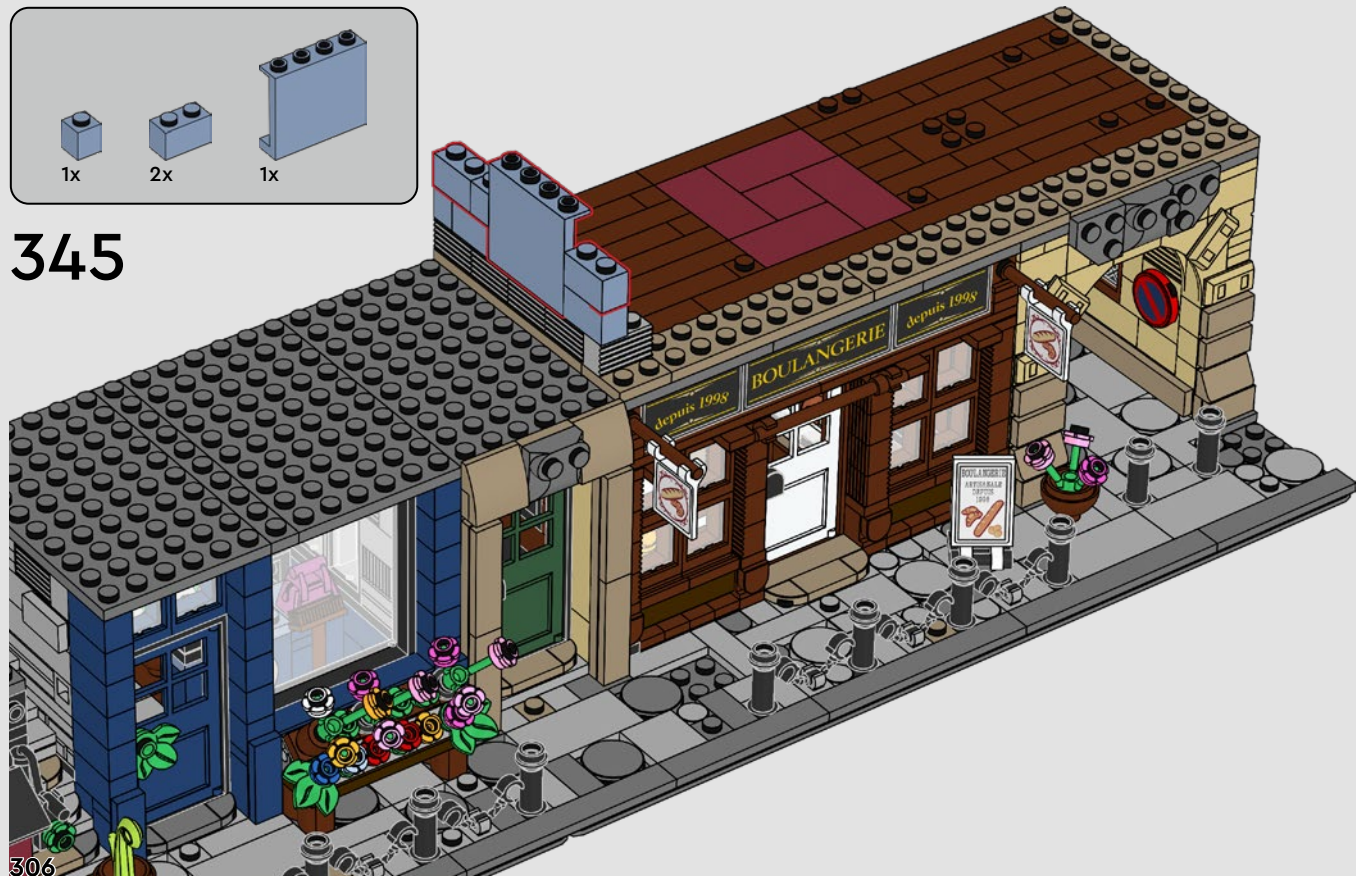



4x

346



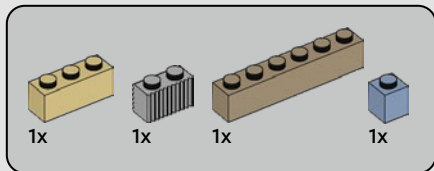

347





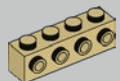

2x



4x

# 348





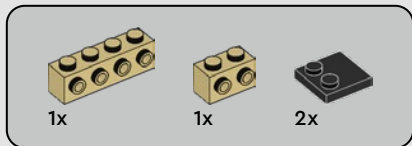

349



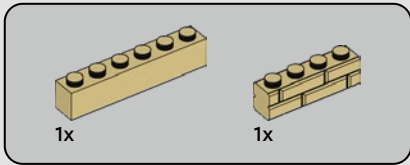

350



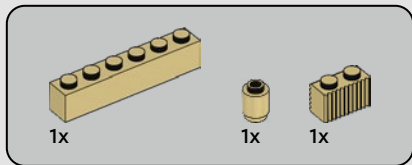

351







3x



3x



3x

# 352

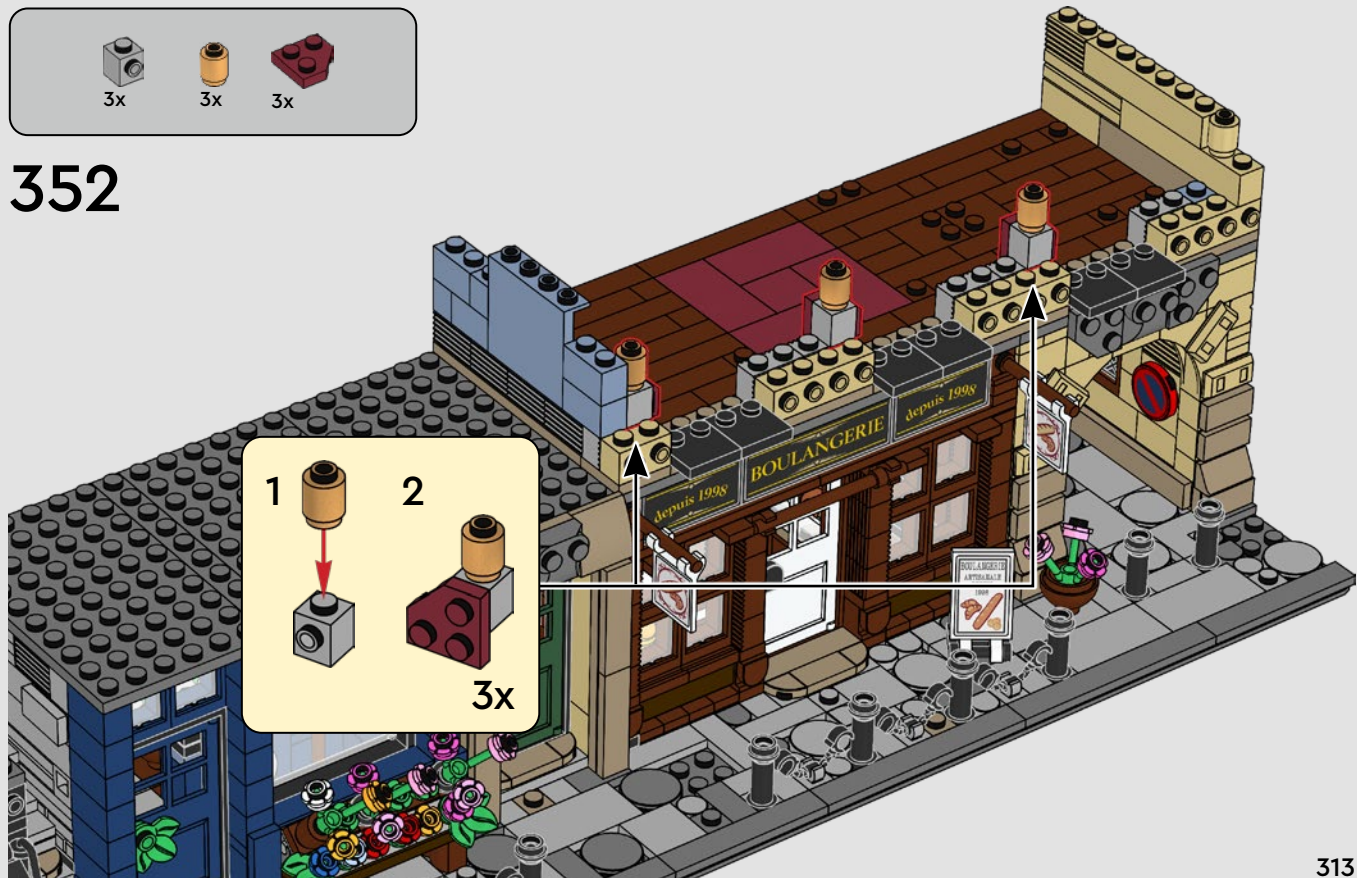





3x



3x



3x

# 353

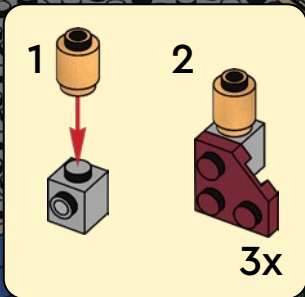

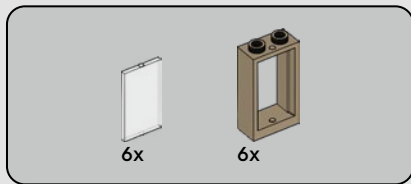

354

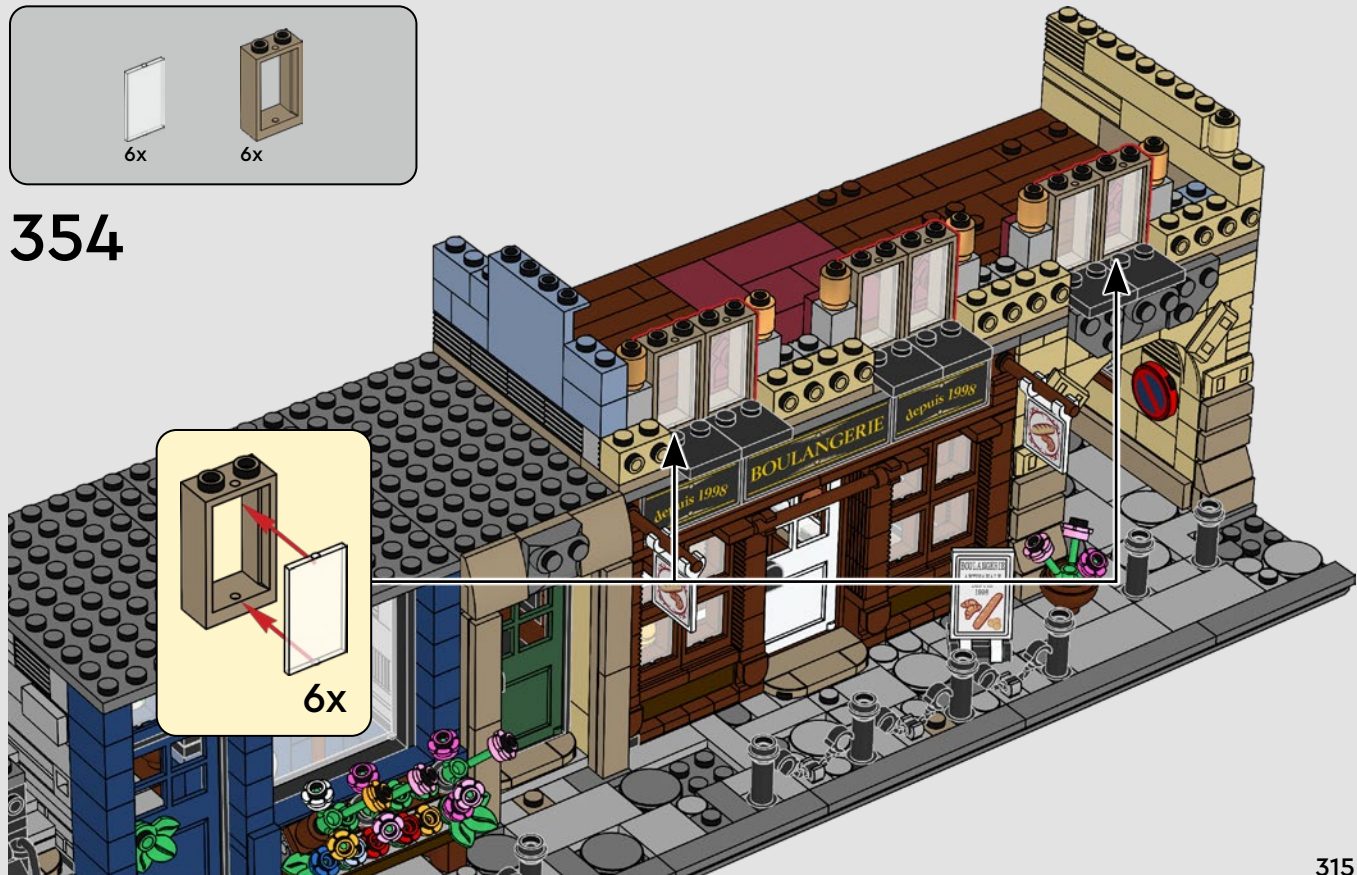



6x

355

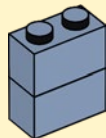

3x





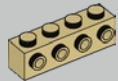

2x



1x



2x

# 356





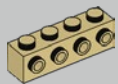

3x



1x

# 357



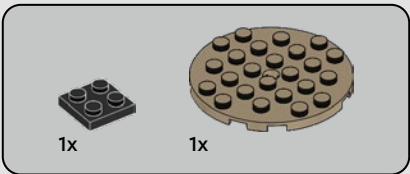

358

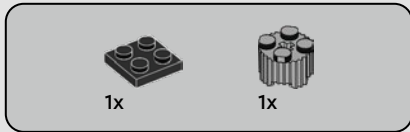

359

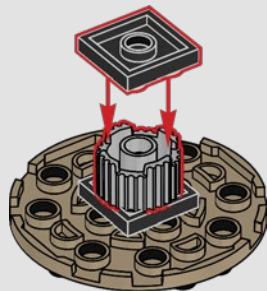

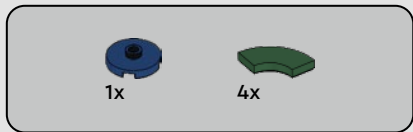

360

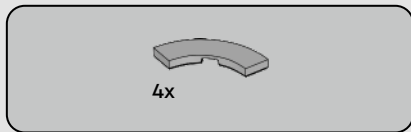
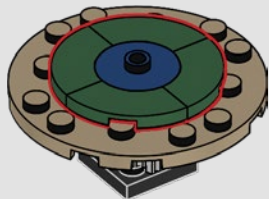

361

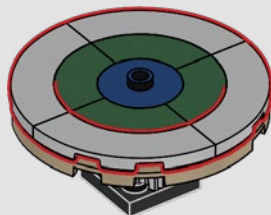

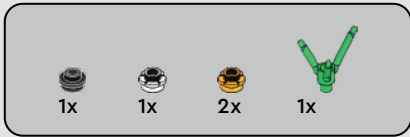

362

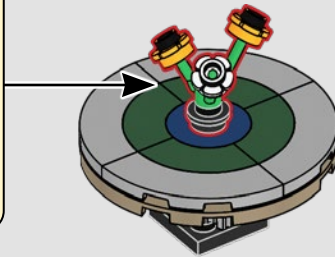
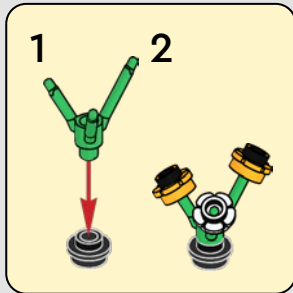



363



322



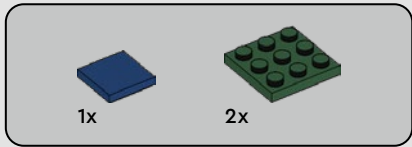
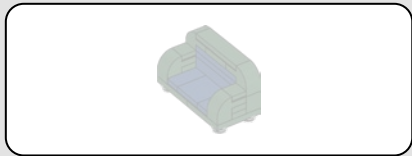

364

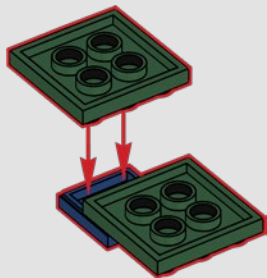

365

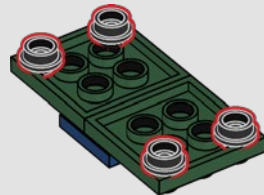

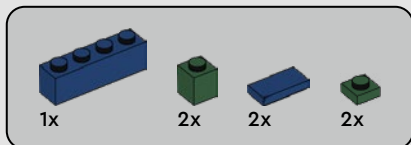

366

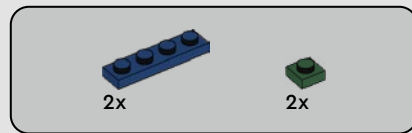
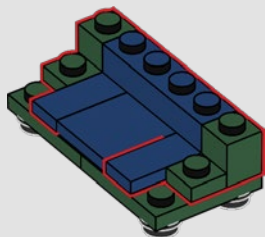

367

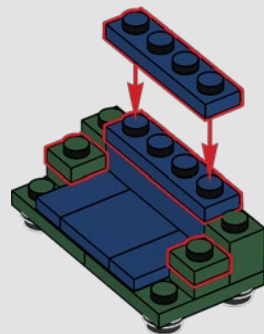



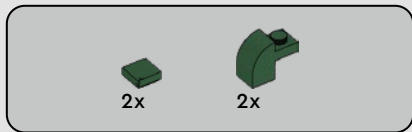

368

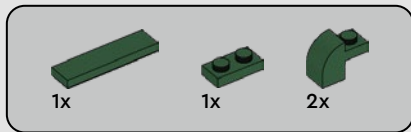
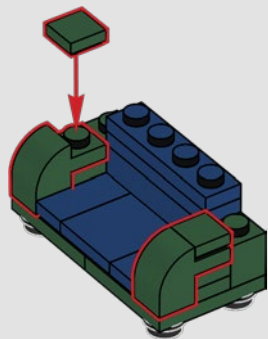

369

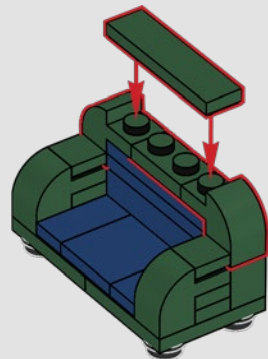

370





1x

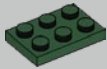

2x

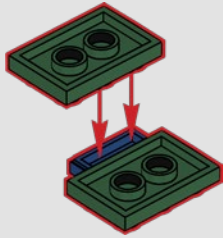

371



4x

372

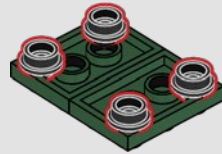

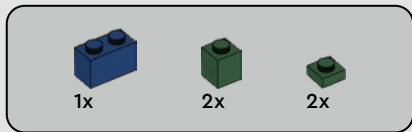

373

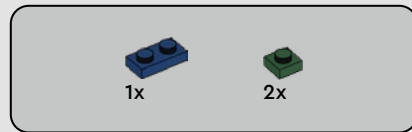
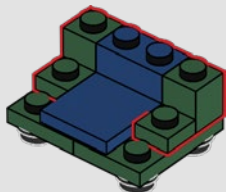

374

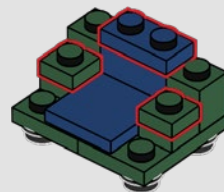



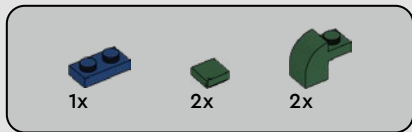

375

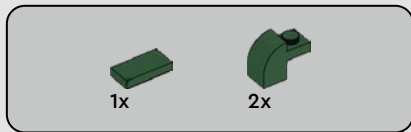
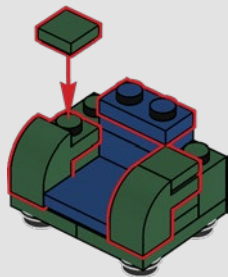

376

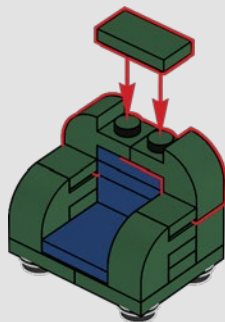

377





378

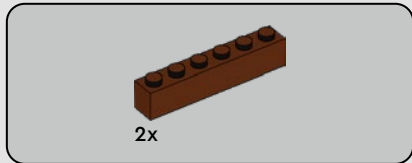
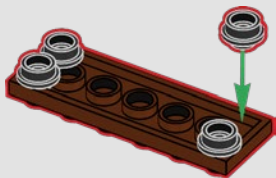

379

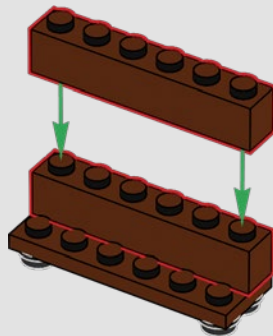

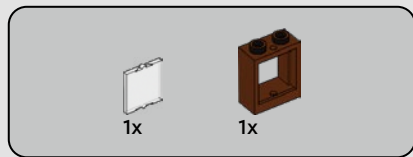

380

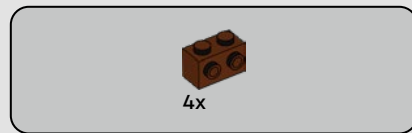
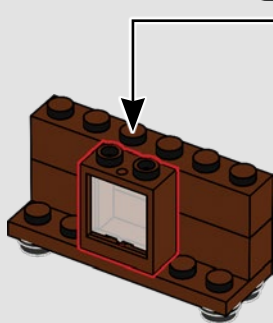
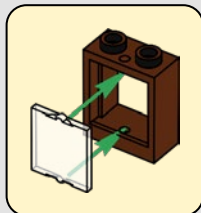

381

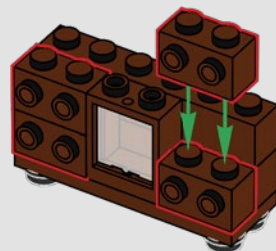



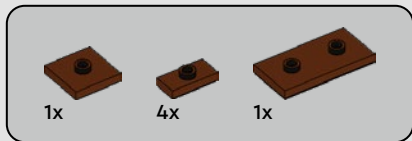

382

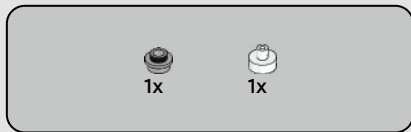
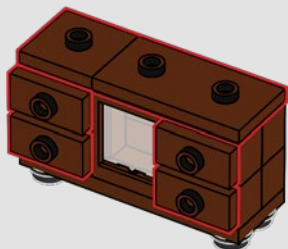

383

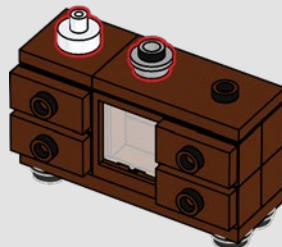

384



385



335

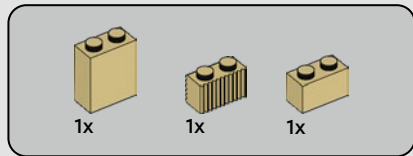

386



336



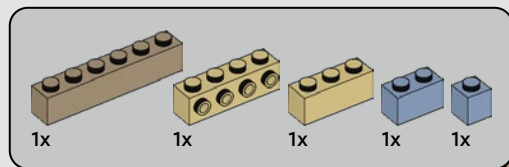

387





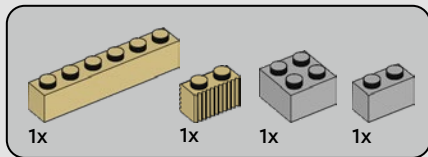

388



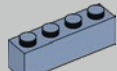

2x

389





2x



2x

390



340



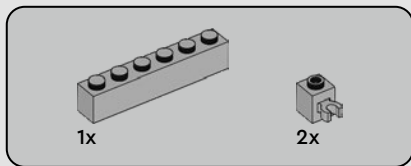

391





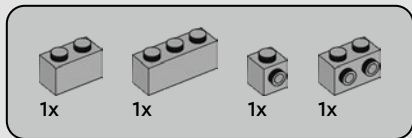

392



342



6x



6x

393



343

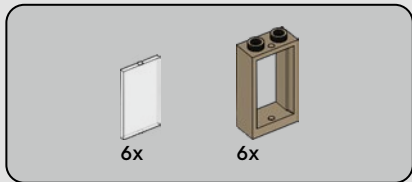

394

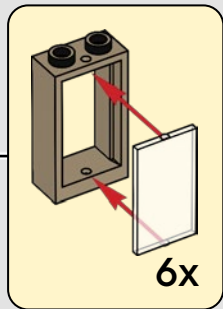
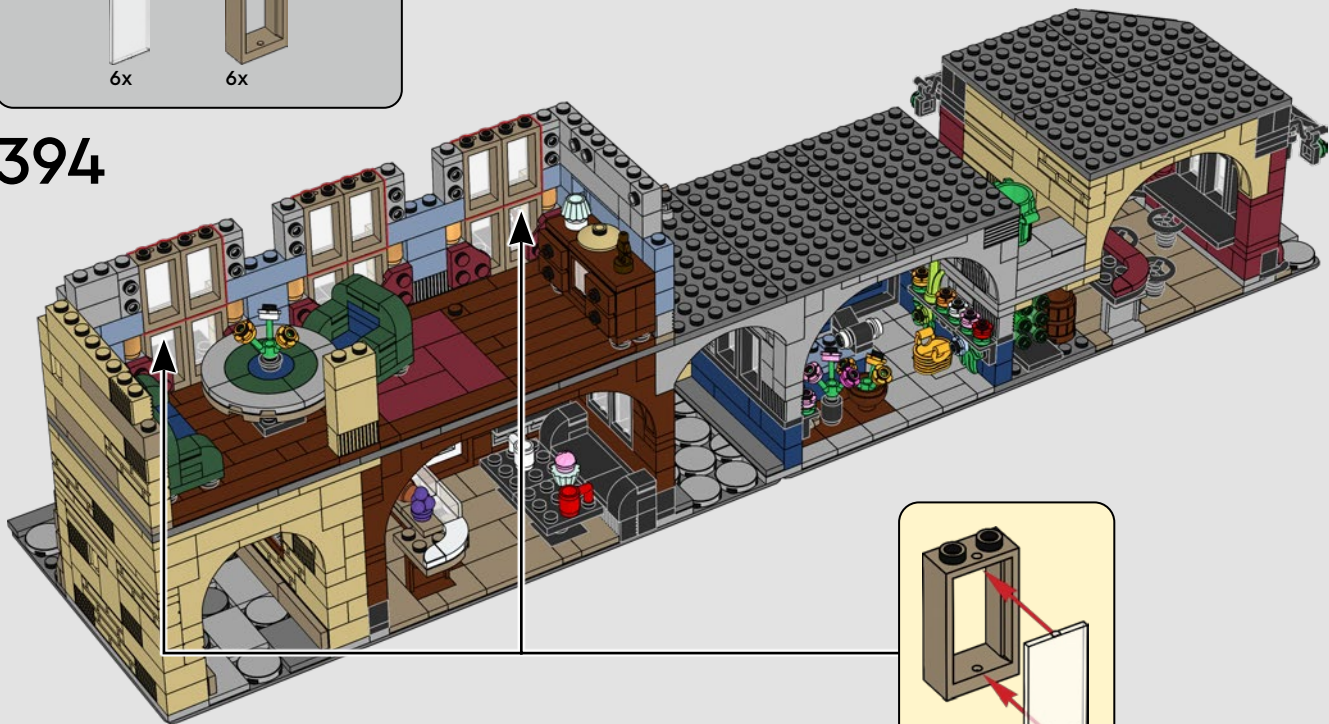



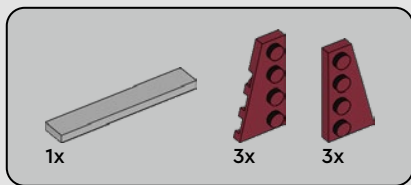

395





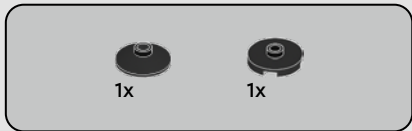

396



397



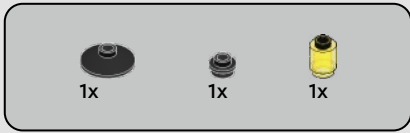

398

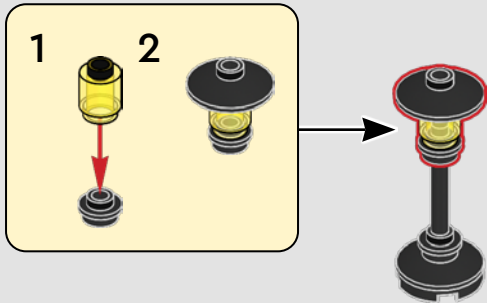

399



348

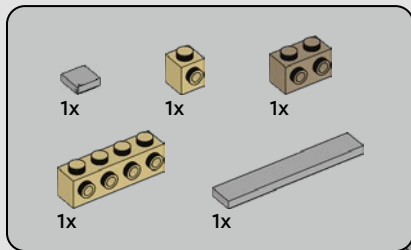

400

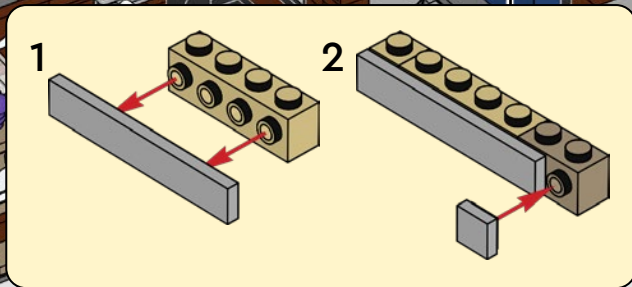





2x

401



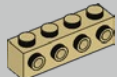

1x



2x

# 402



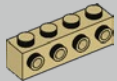

1x



2x

# 403







2x

404









2x



2x

# 406



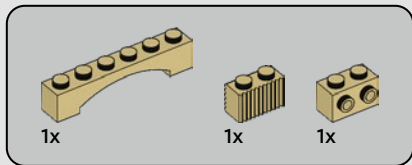

407

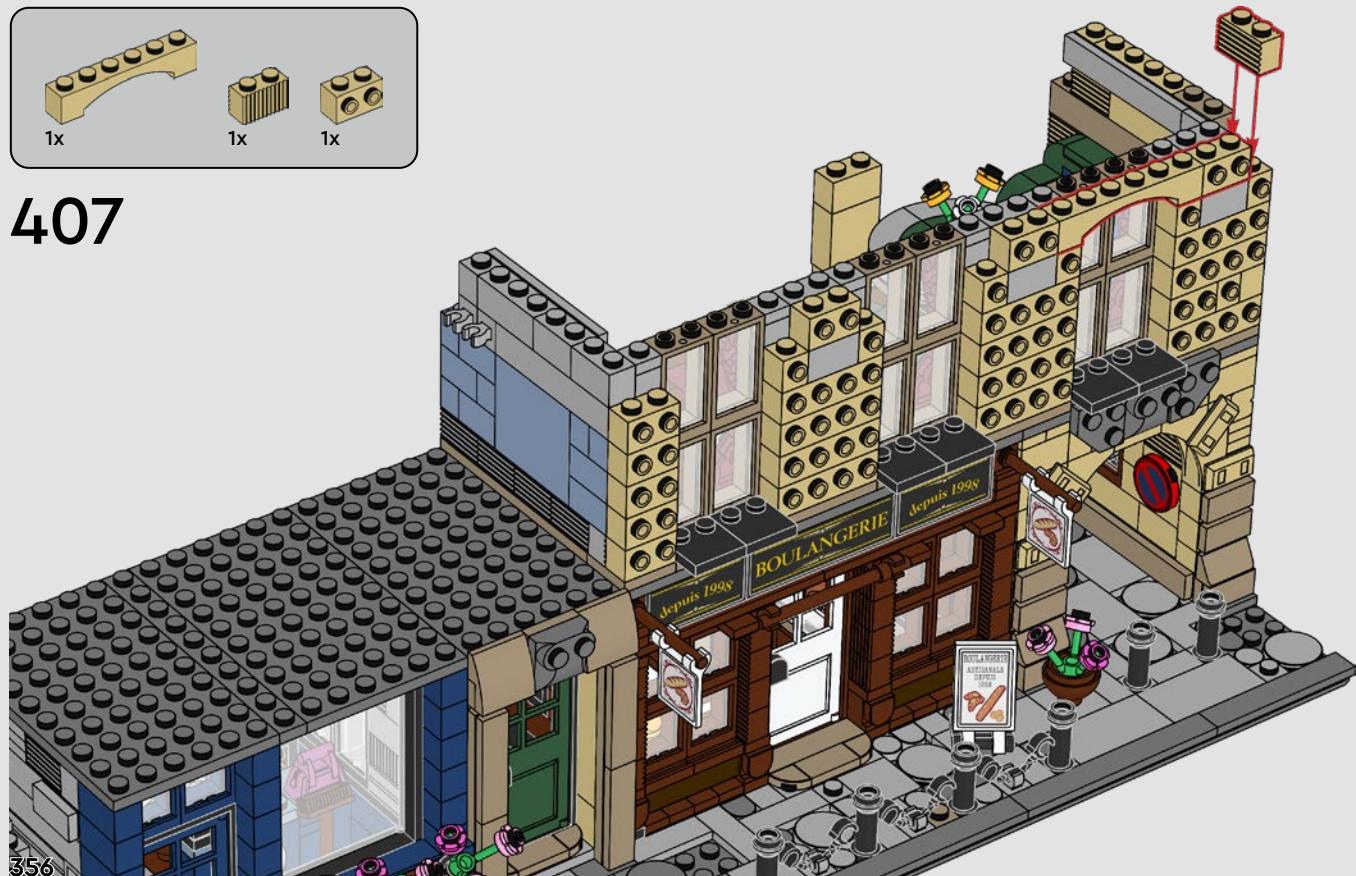





1x



2x

# 408





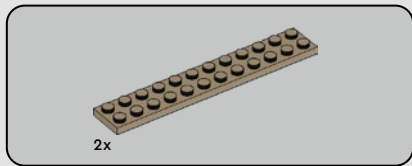

409



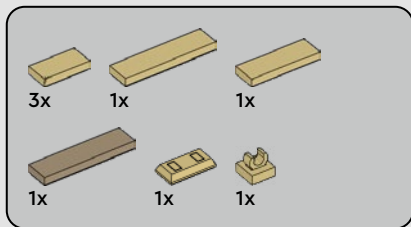

410

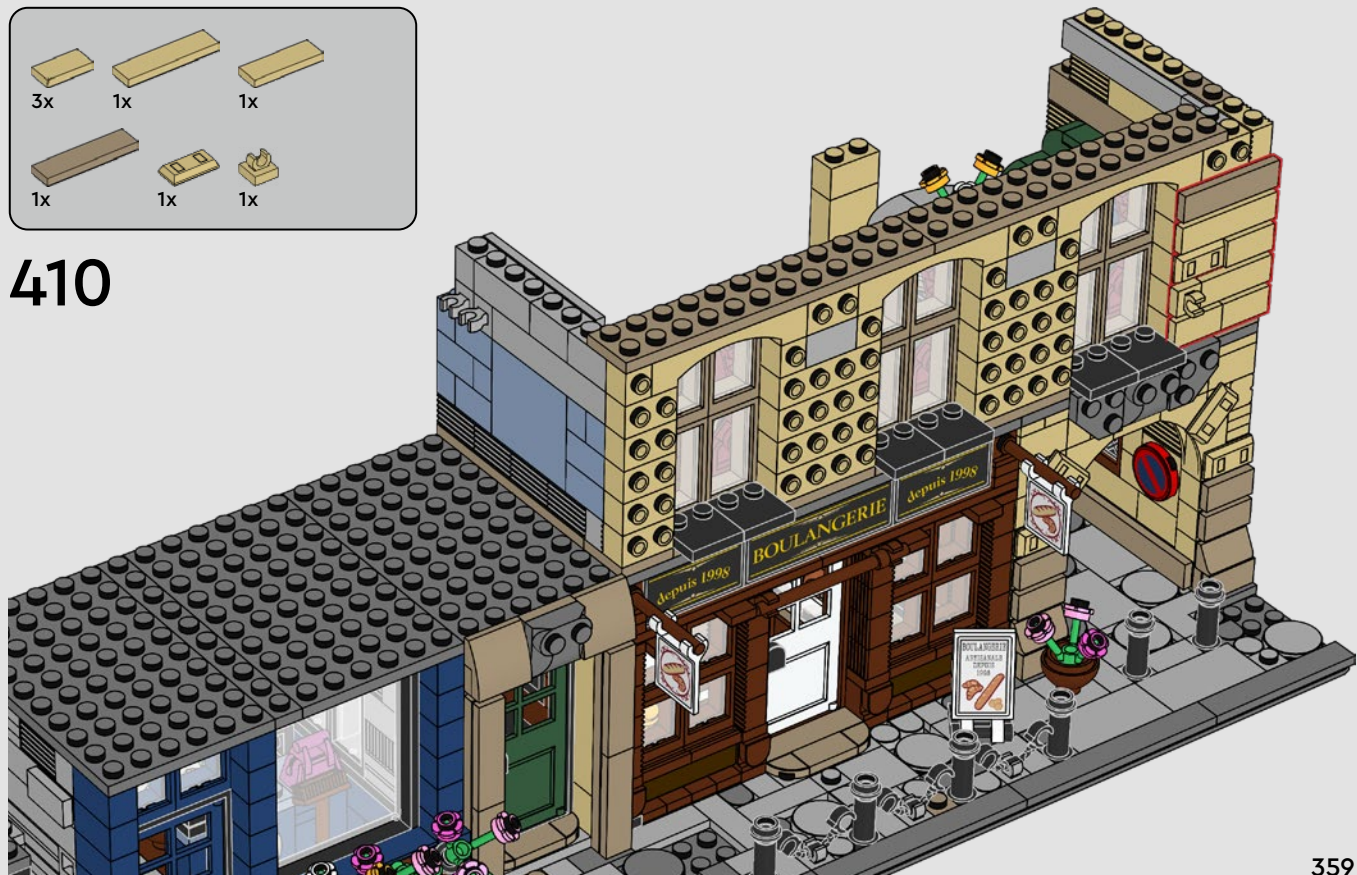

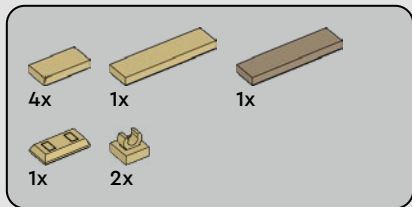

411

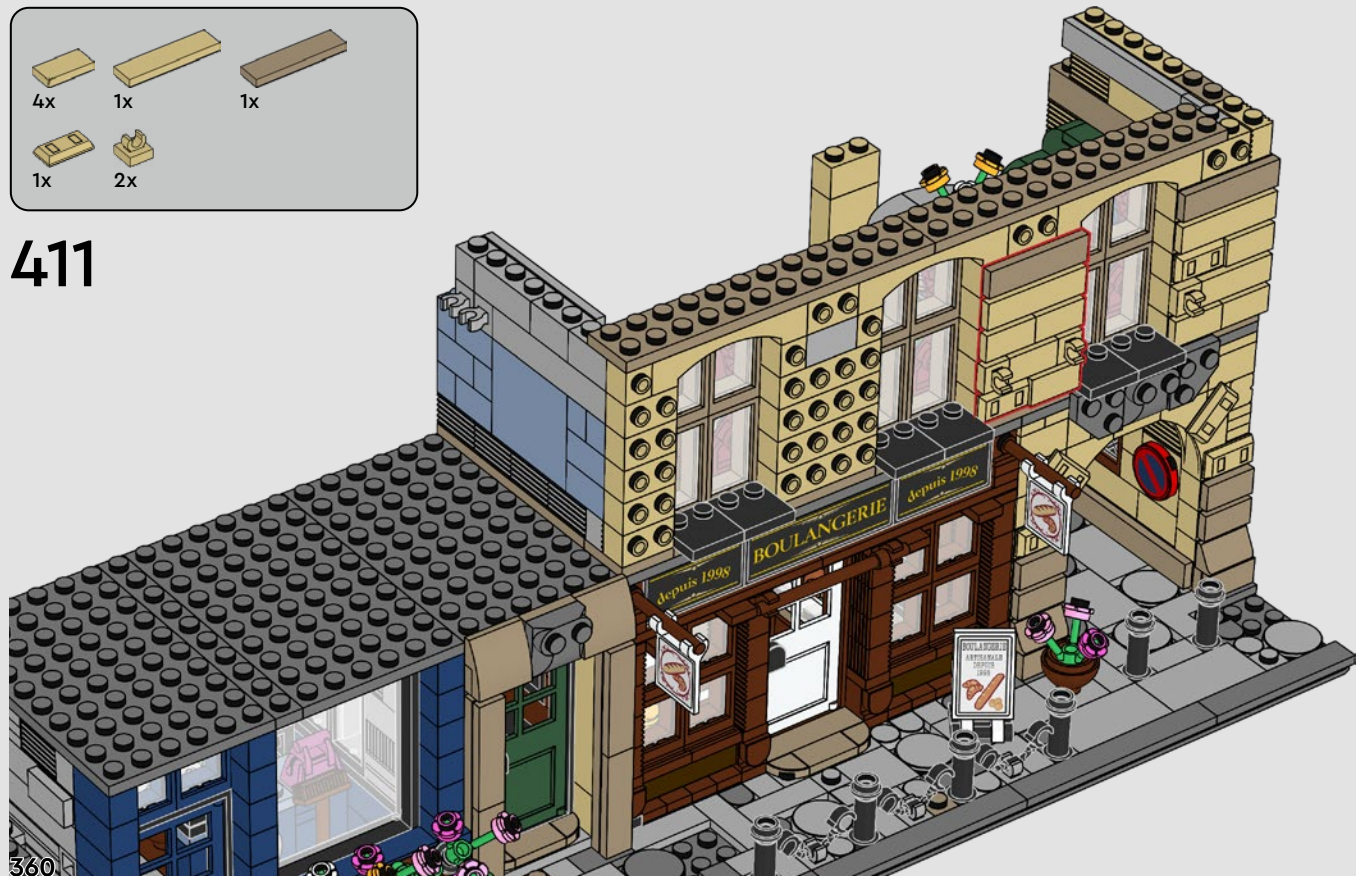







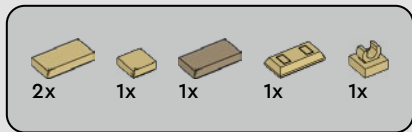

413



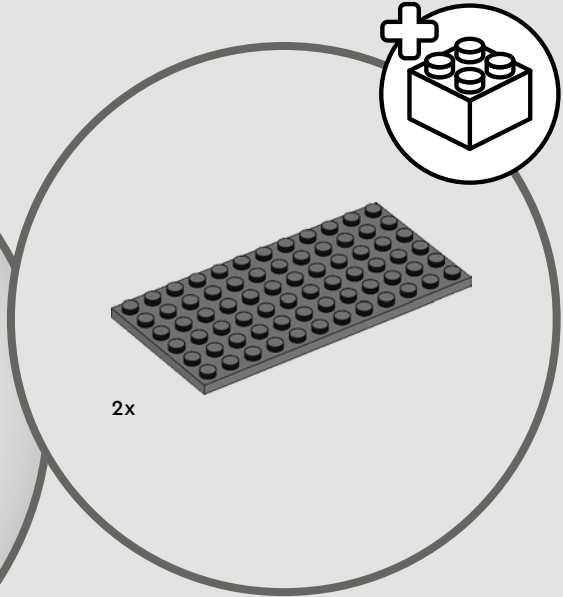
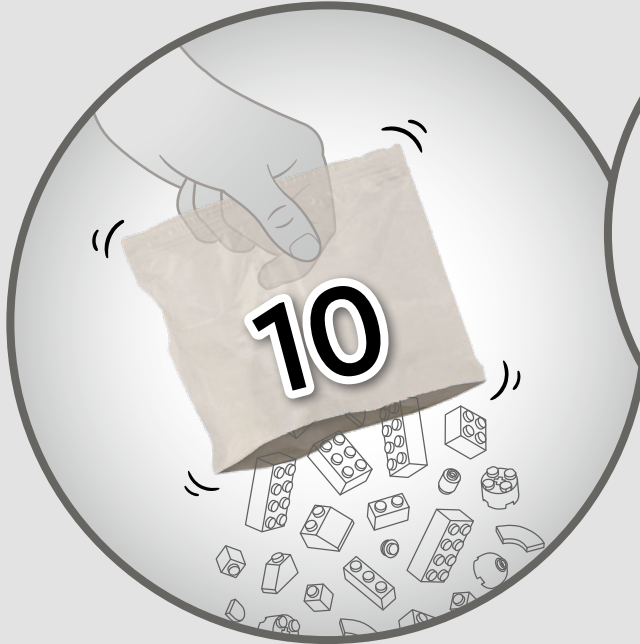

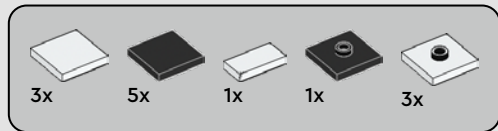

414





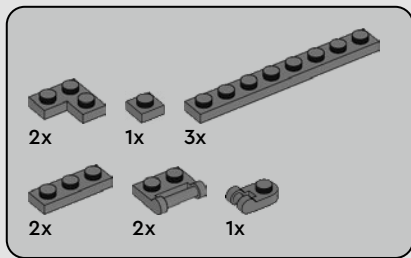

415







4x



12x

# 416





2x



6x

417





2x



1x

# 418





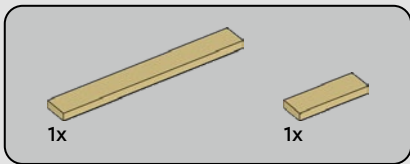

419







420

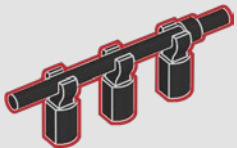

421

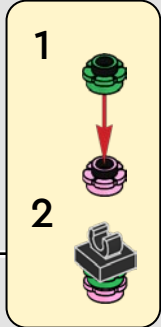
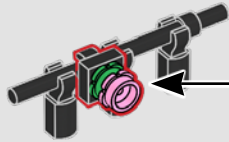

422

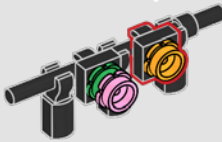

423





424

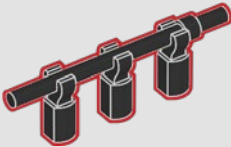

425

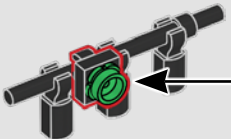

426

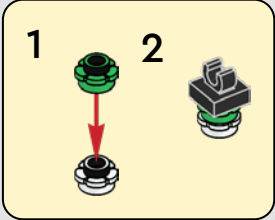
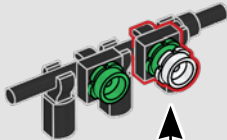

427







428

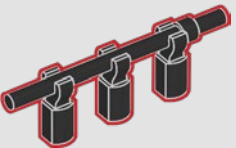

429

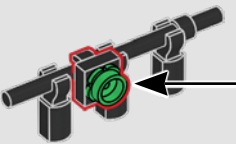

430

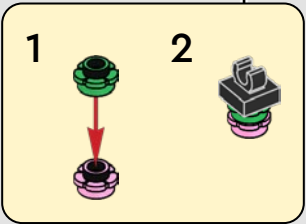
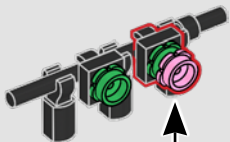

431



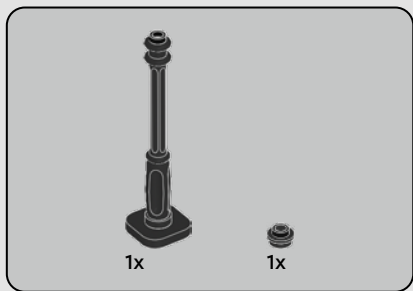
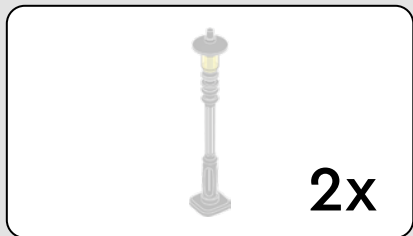

432





433



434

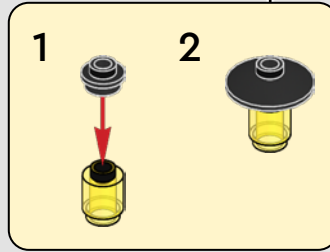

2x  
377



435





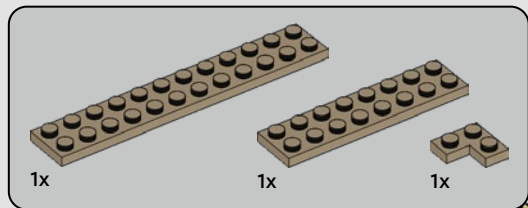

437

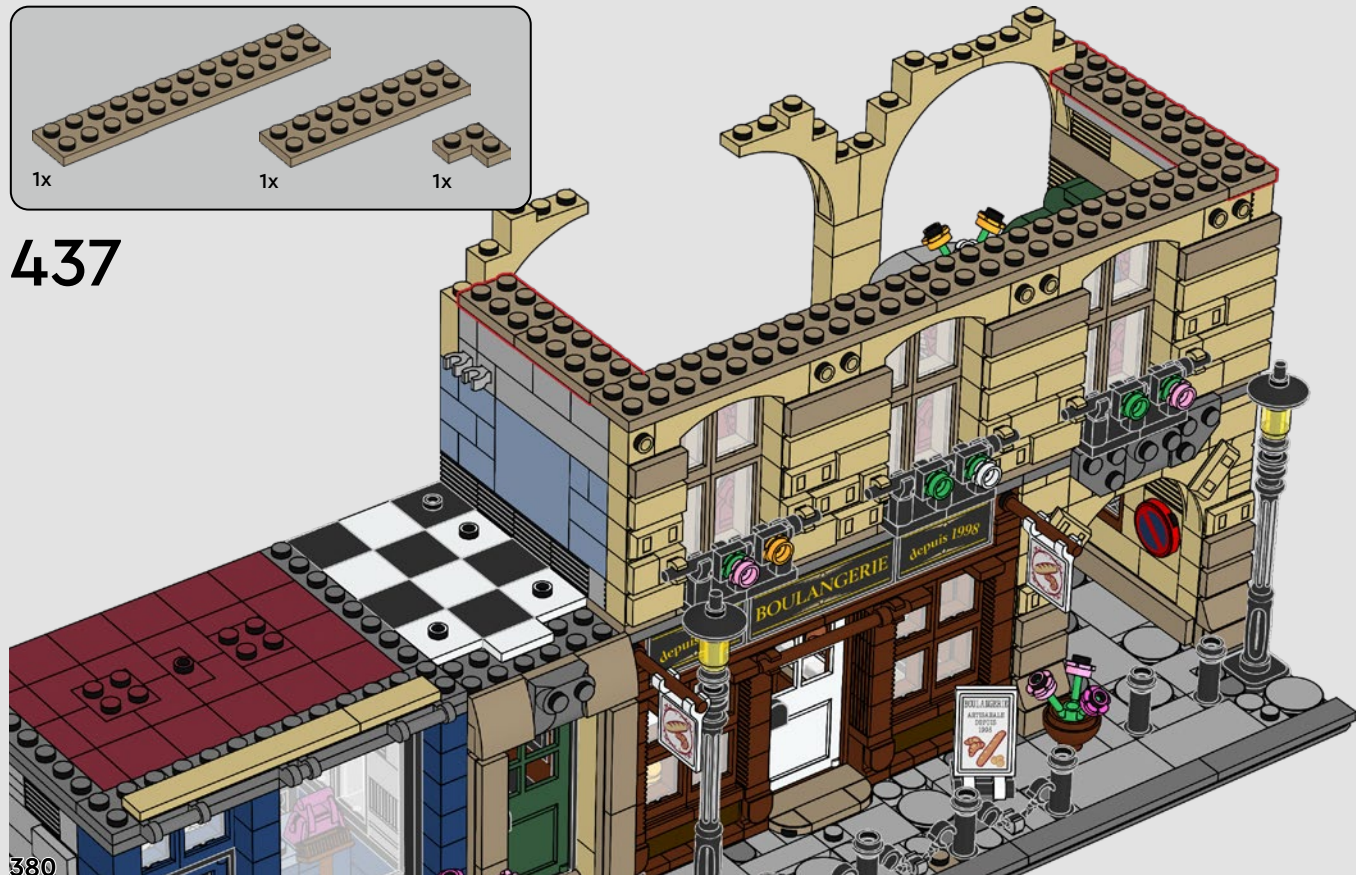



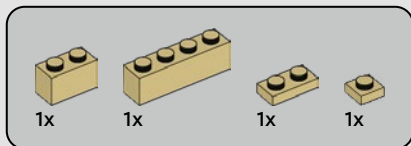

438







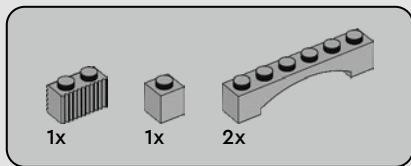

440

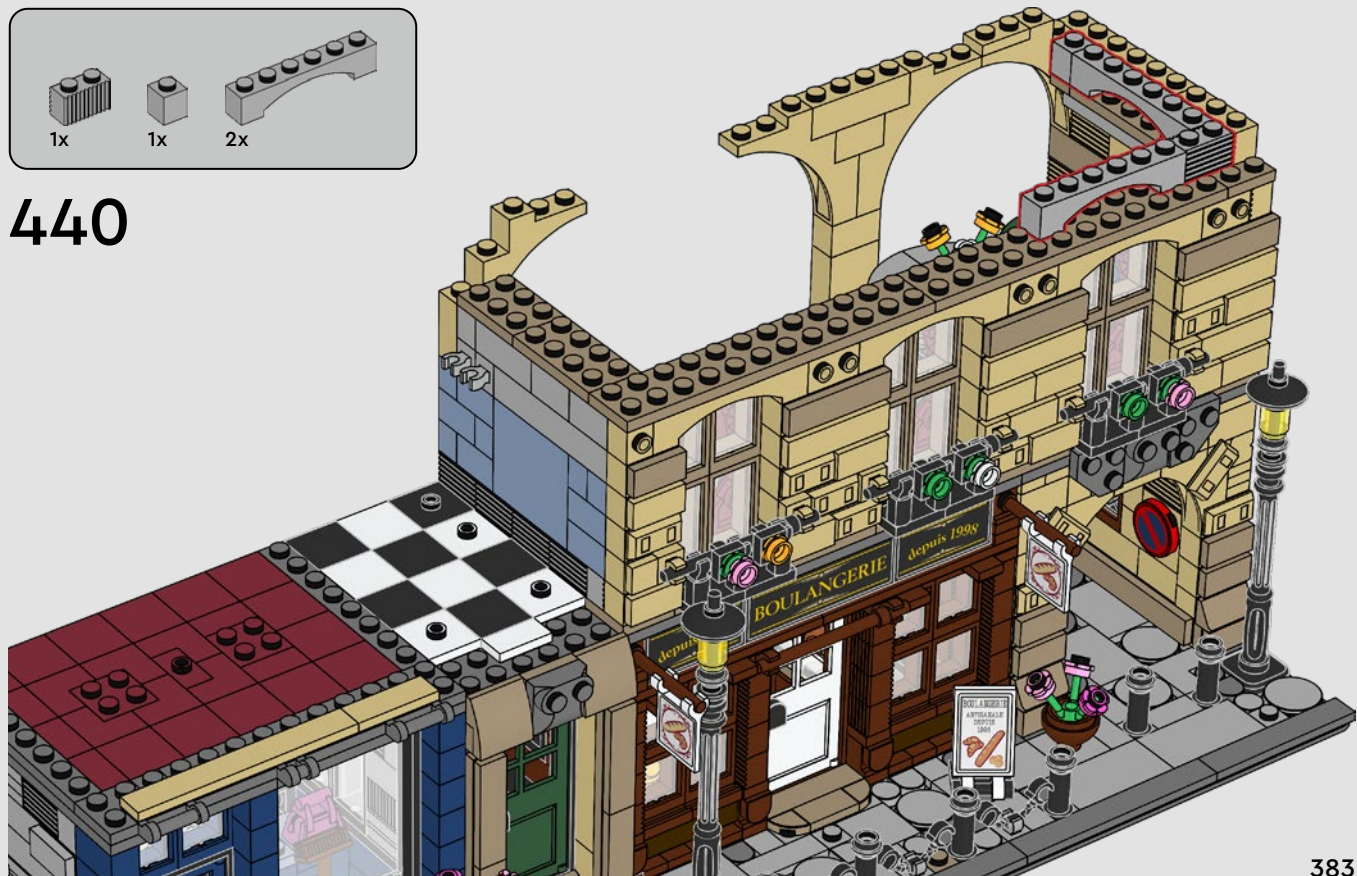

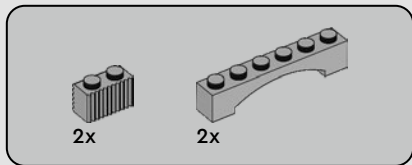

441

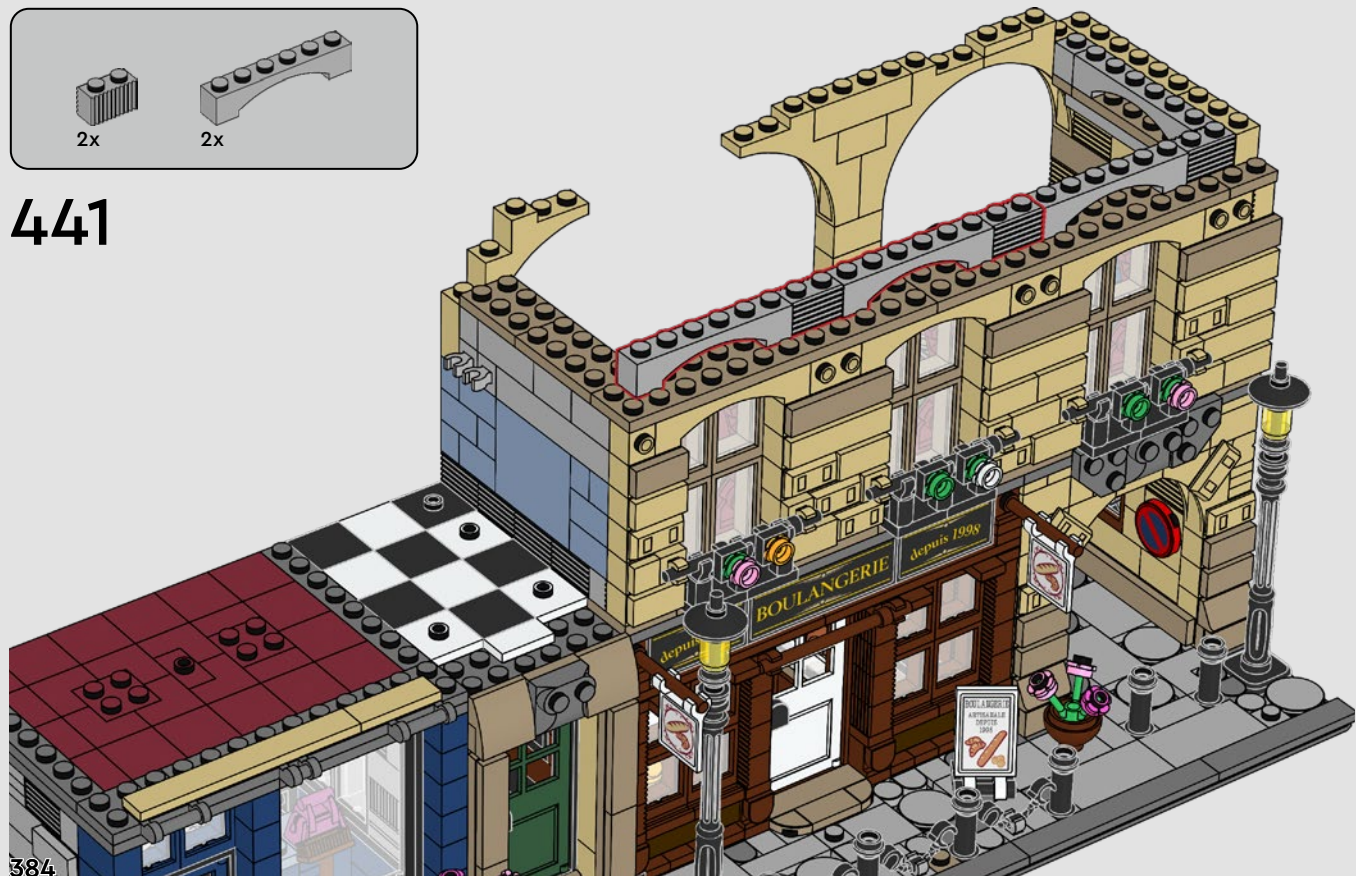



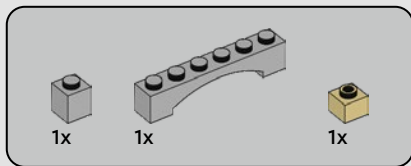

442

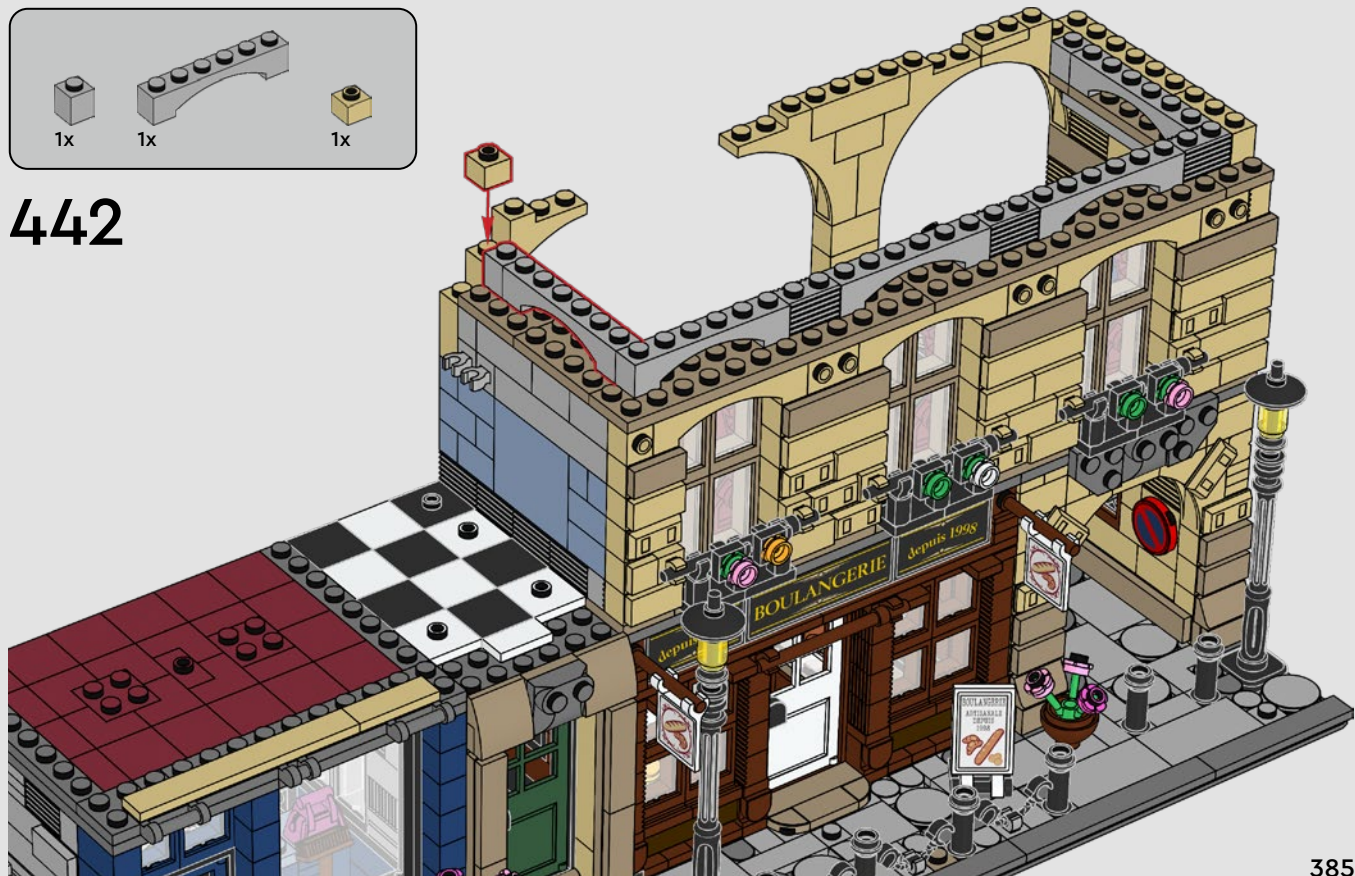



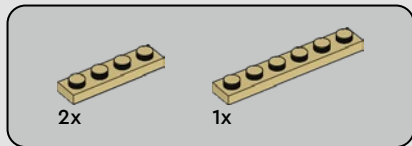

443

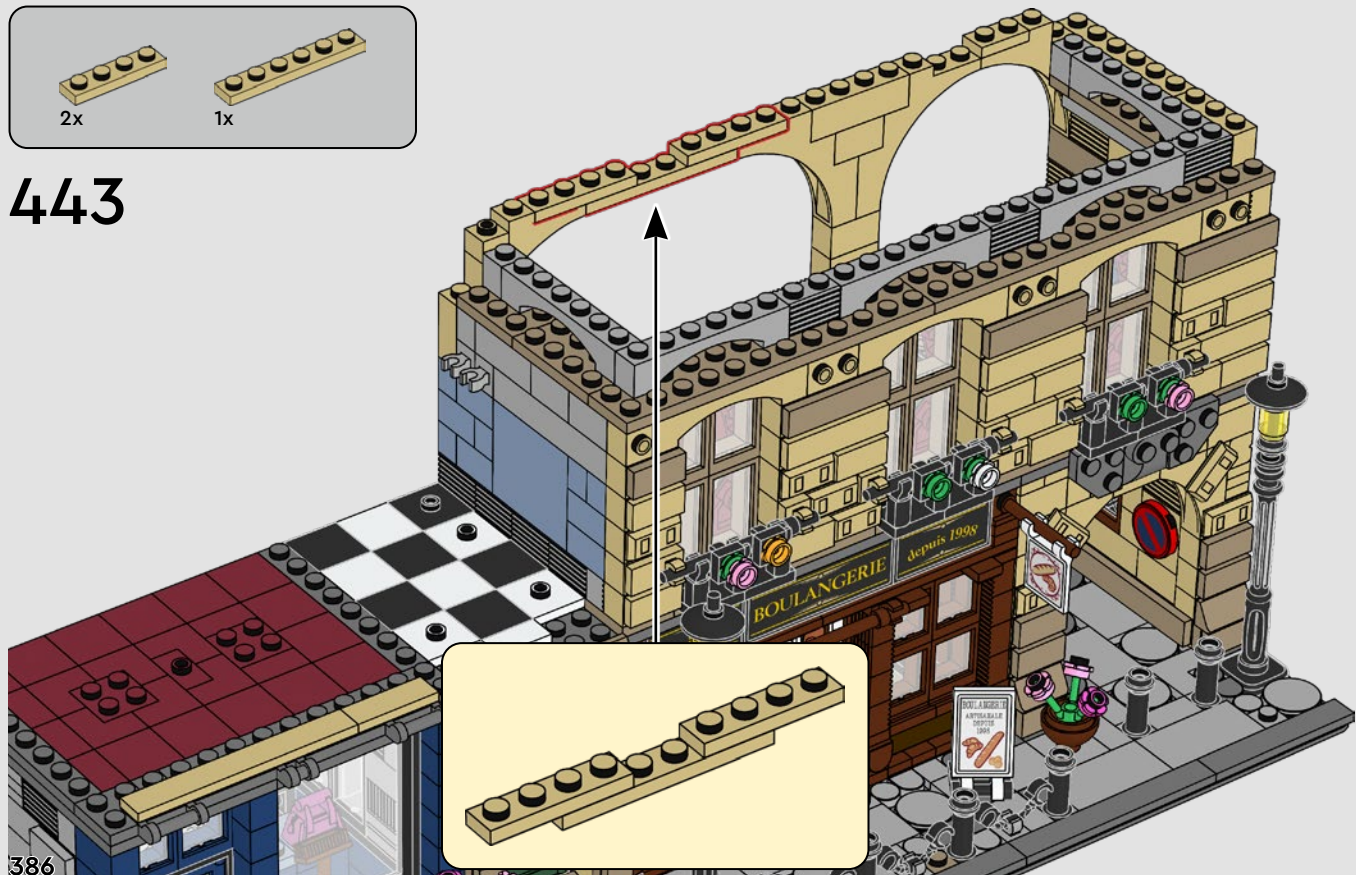

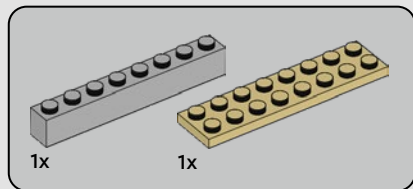

444

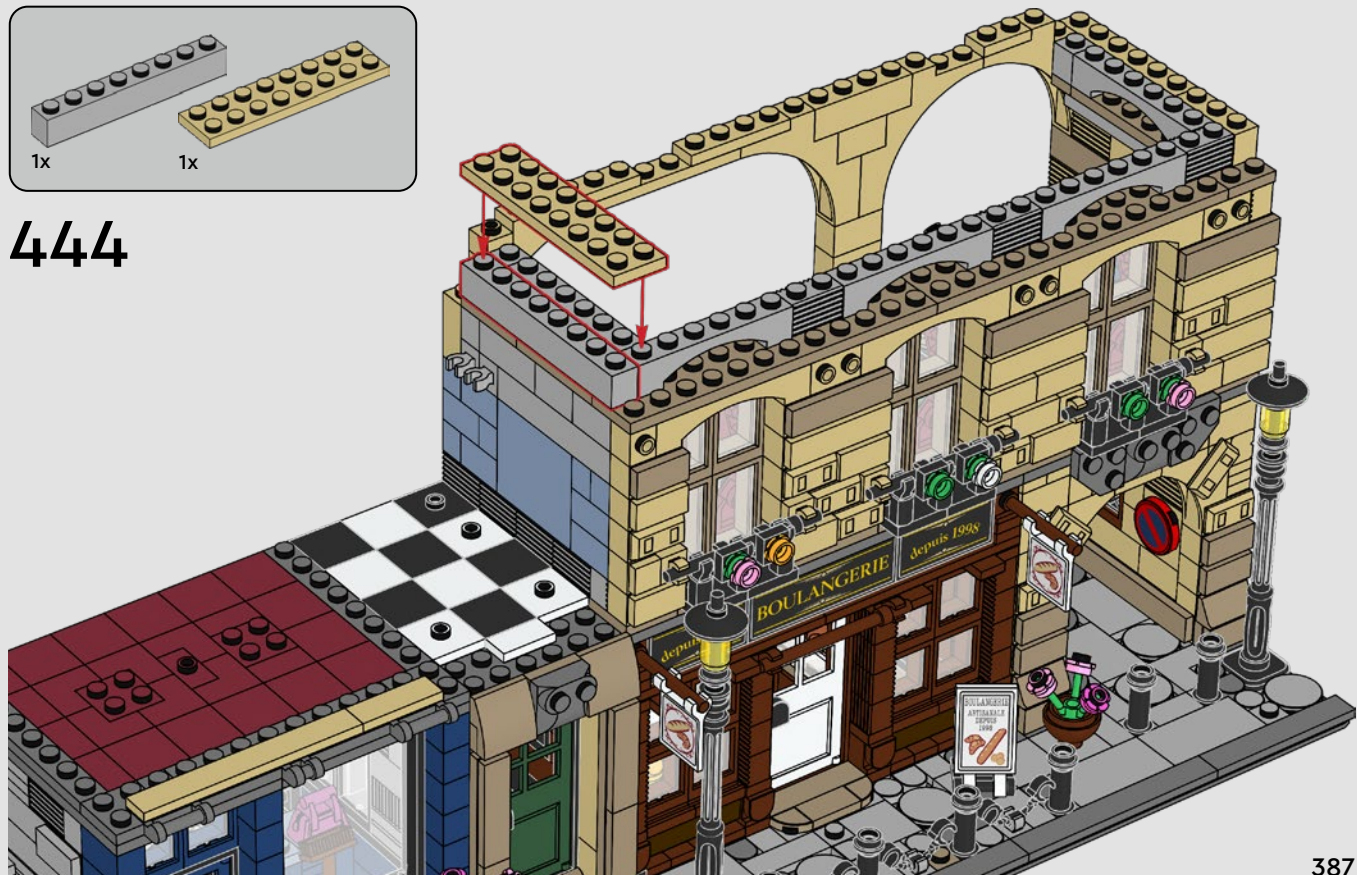

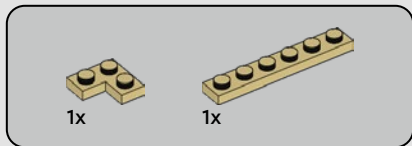

445

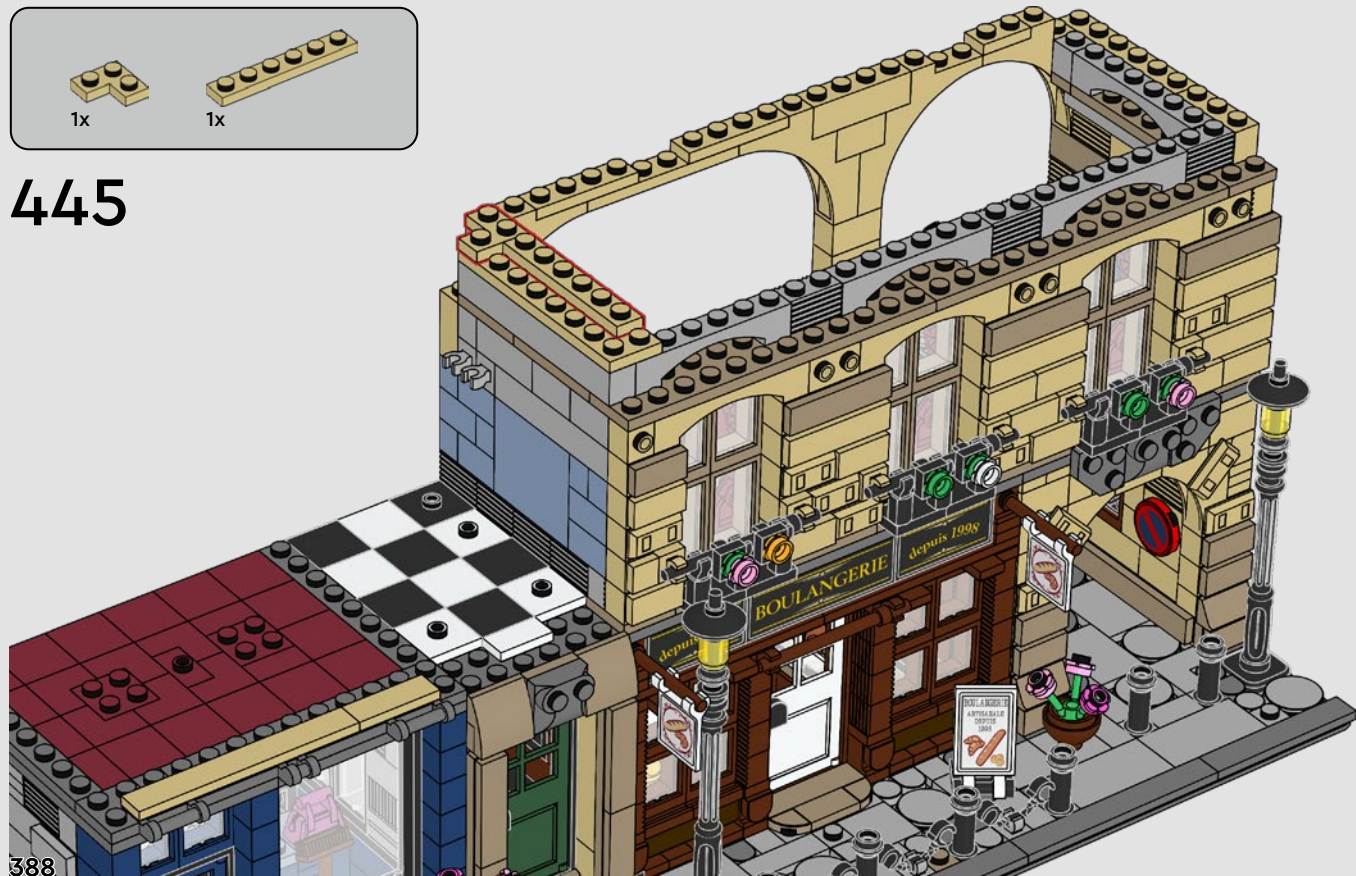



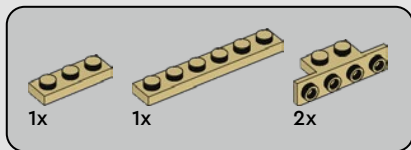

446

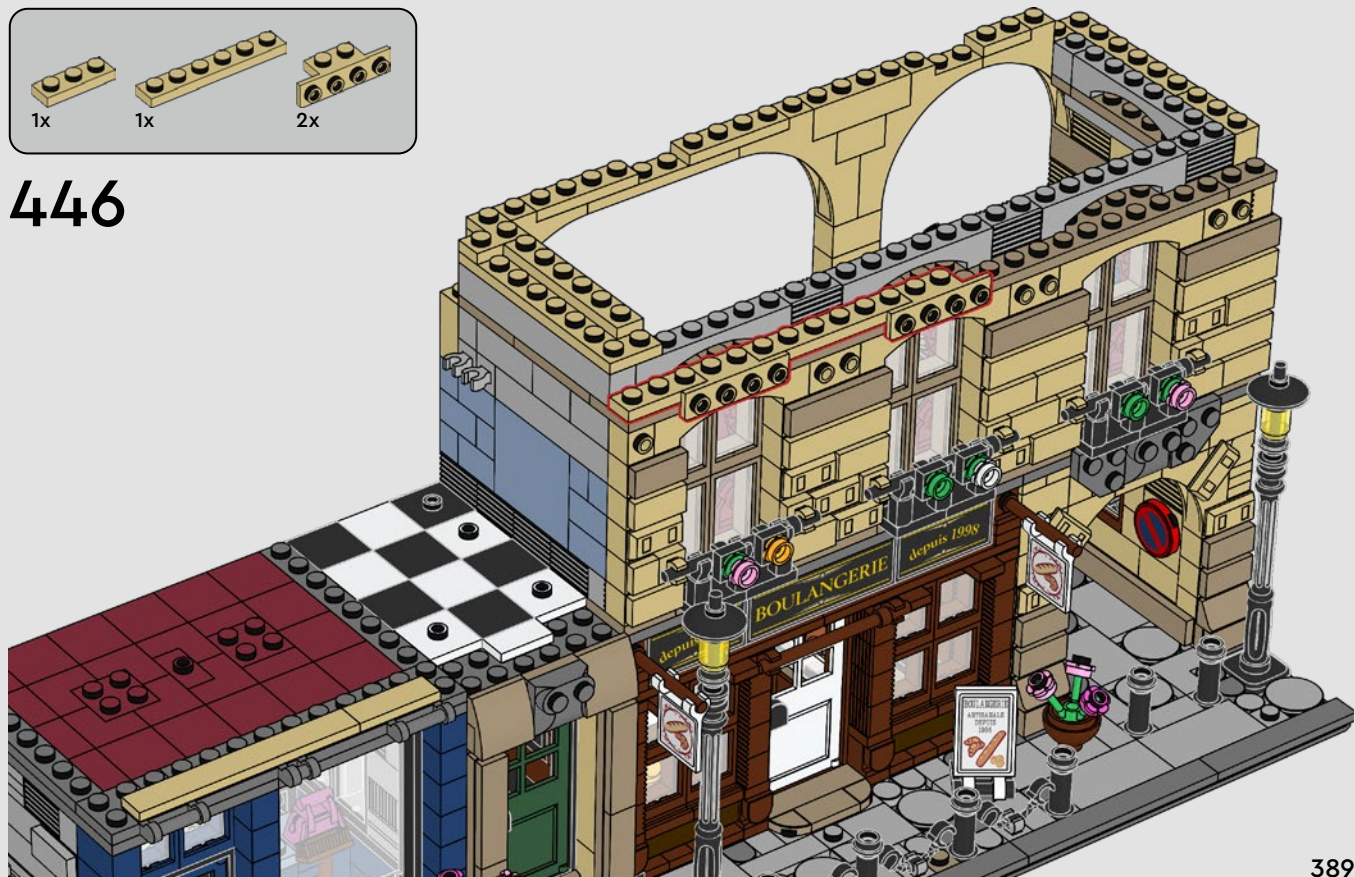



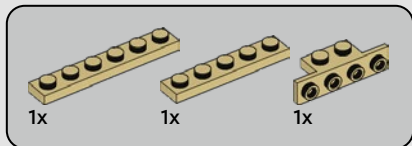

447



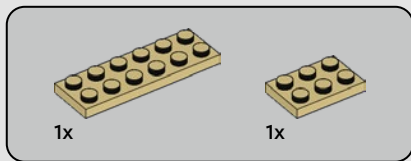

448





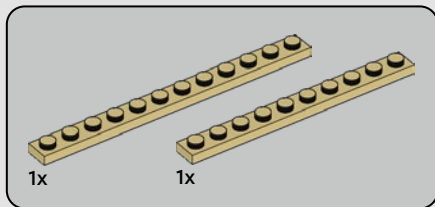

449

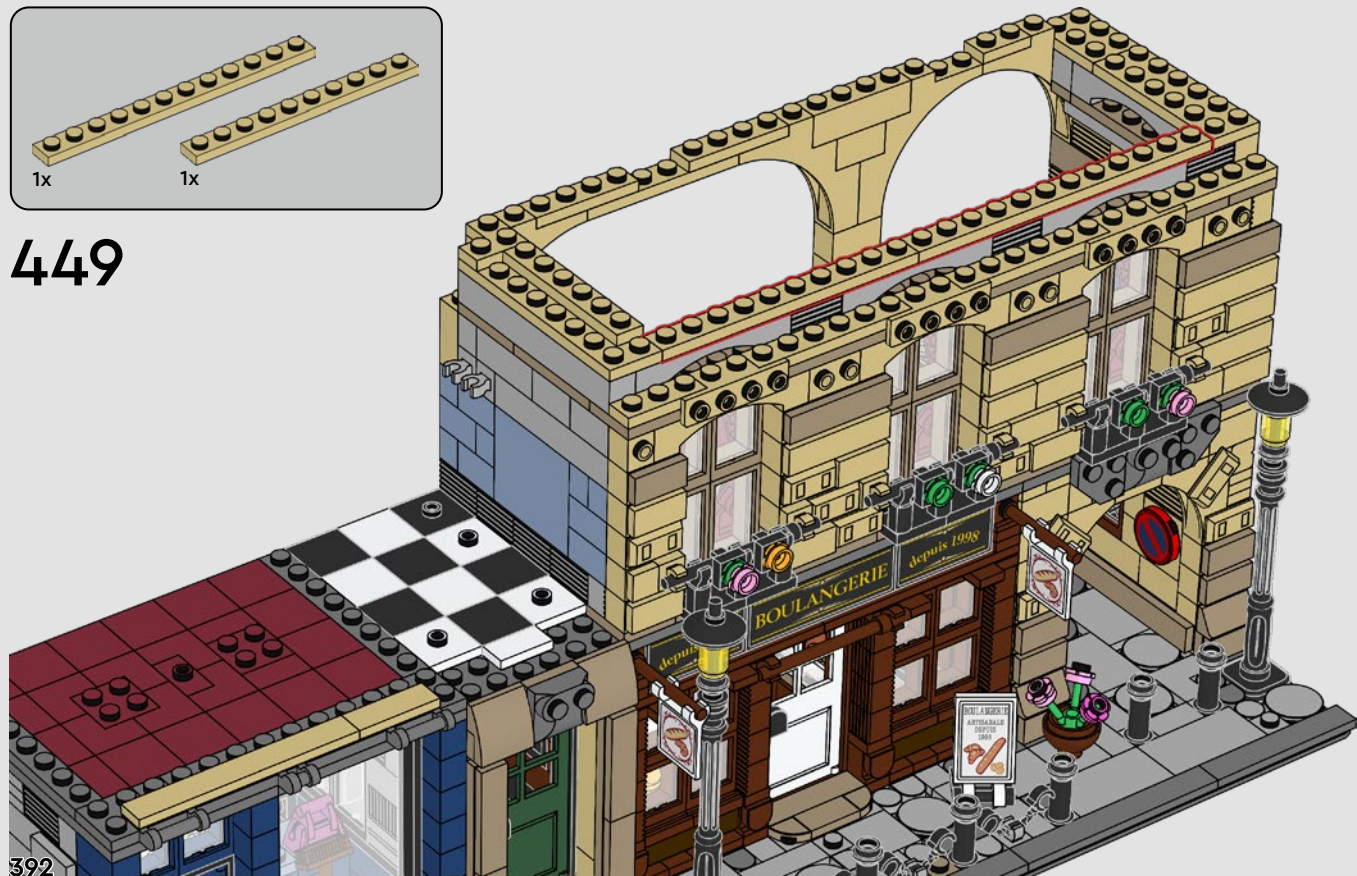

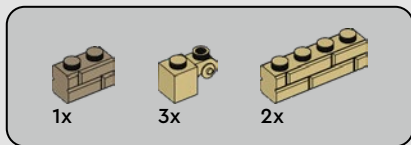

450





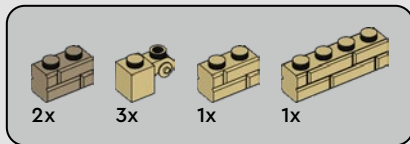

451

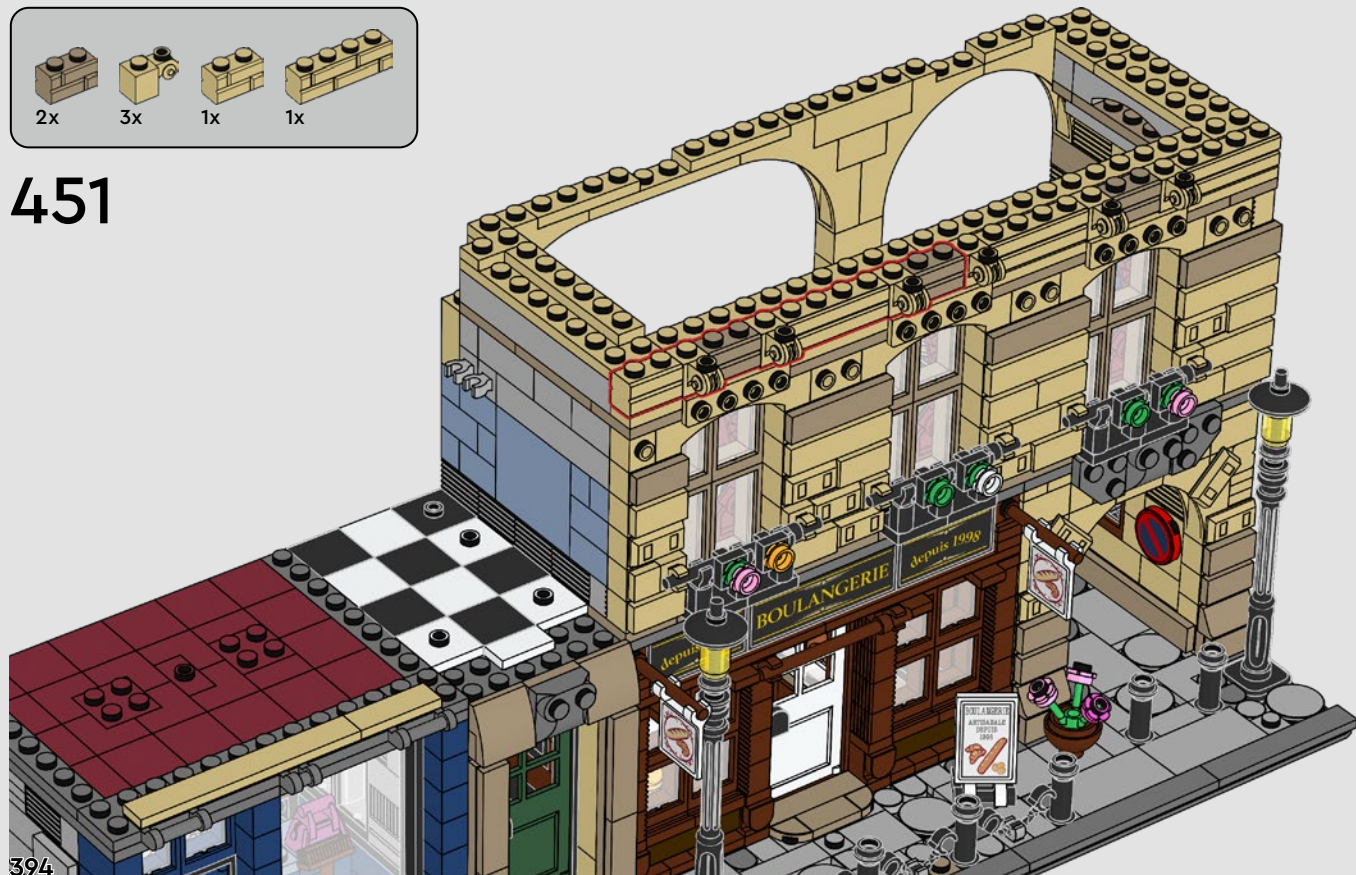

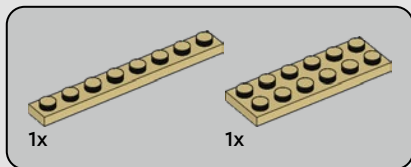

452

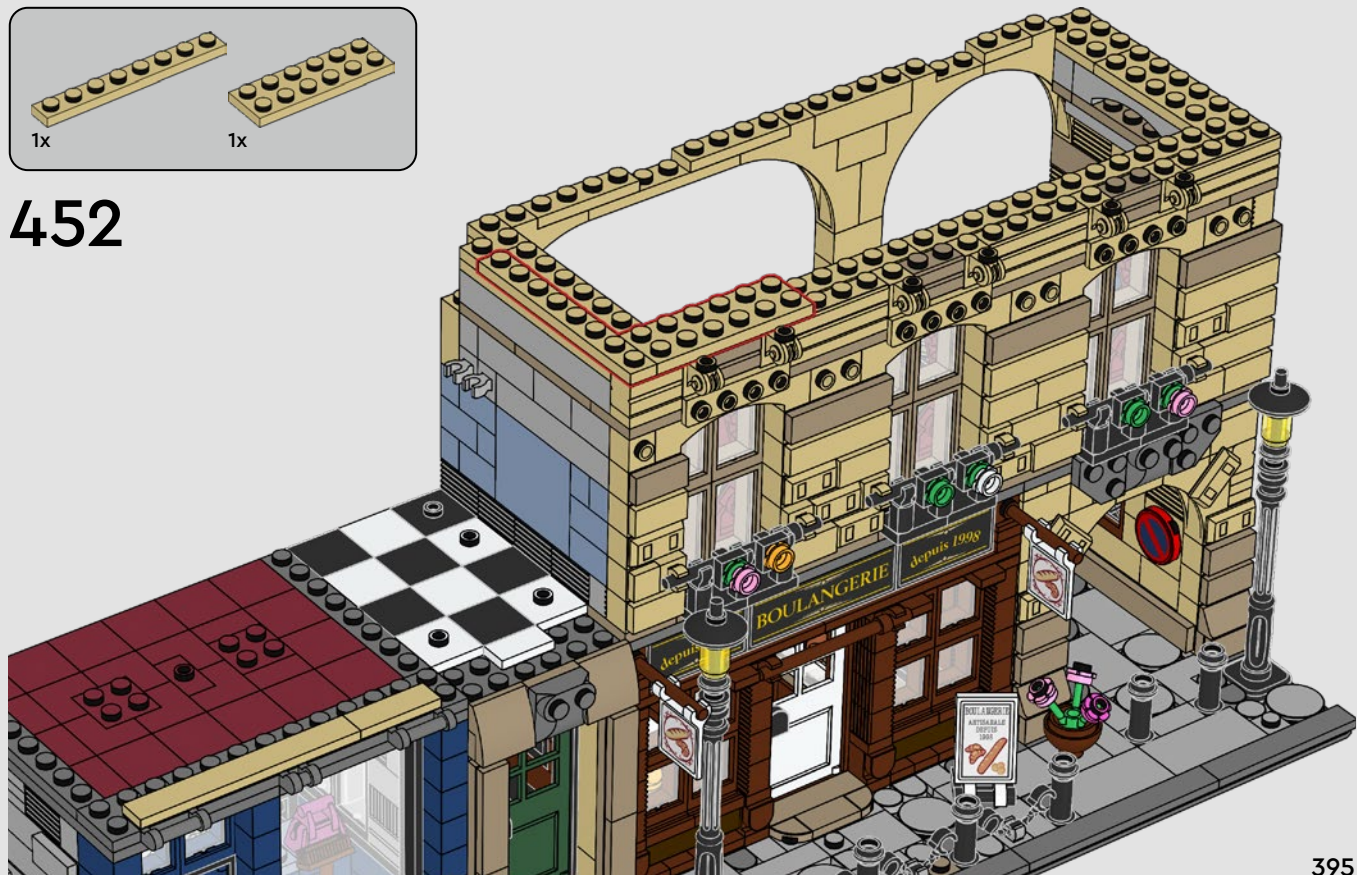



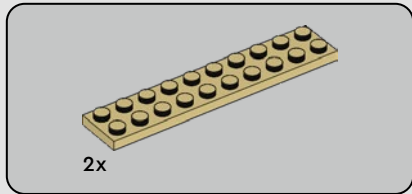

453

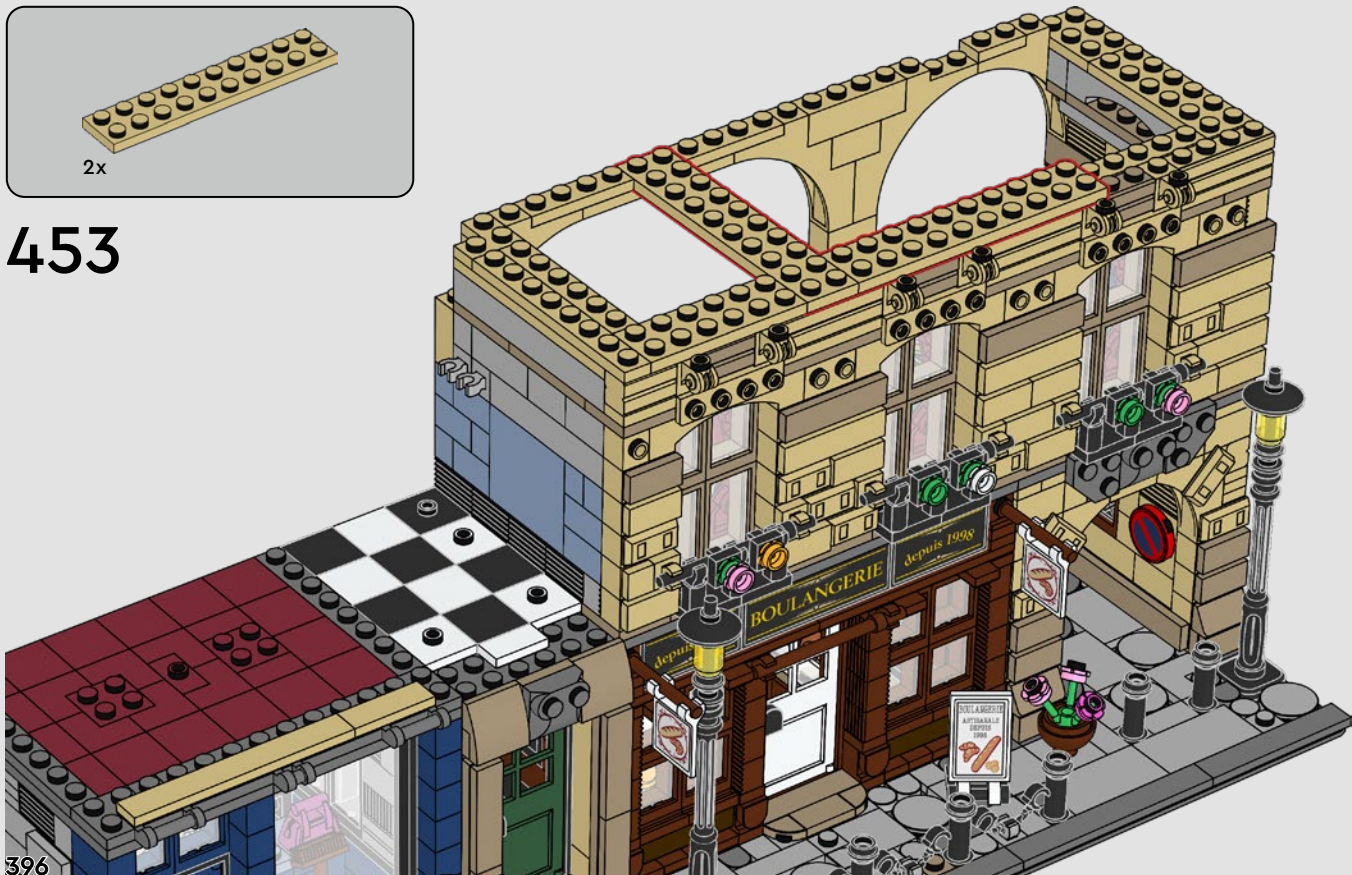







4x

455





3x



1x

# 456







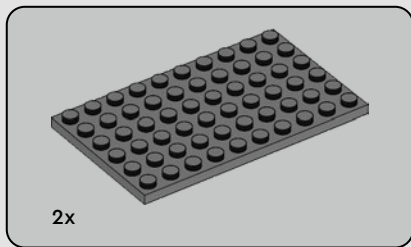

458

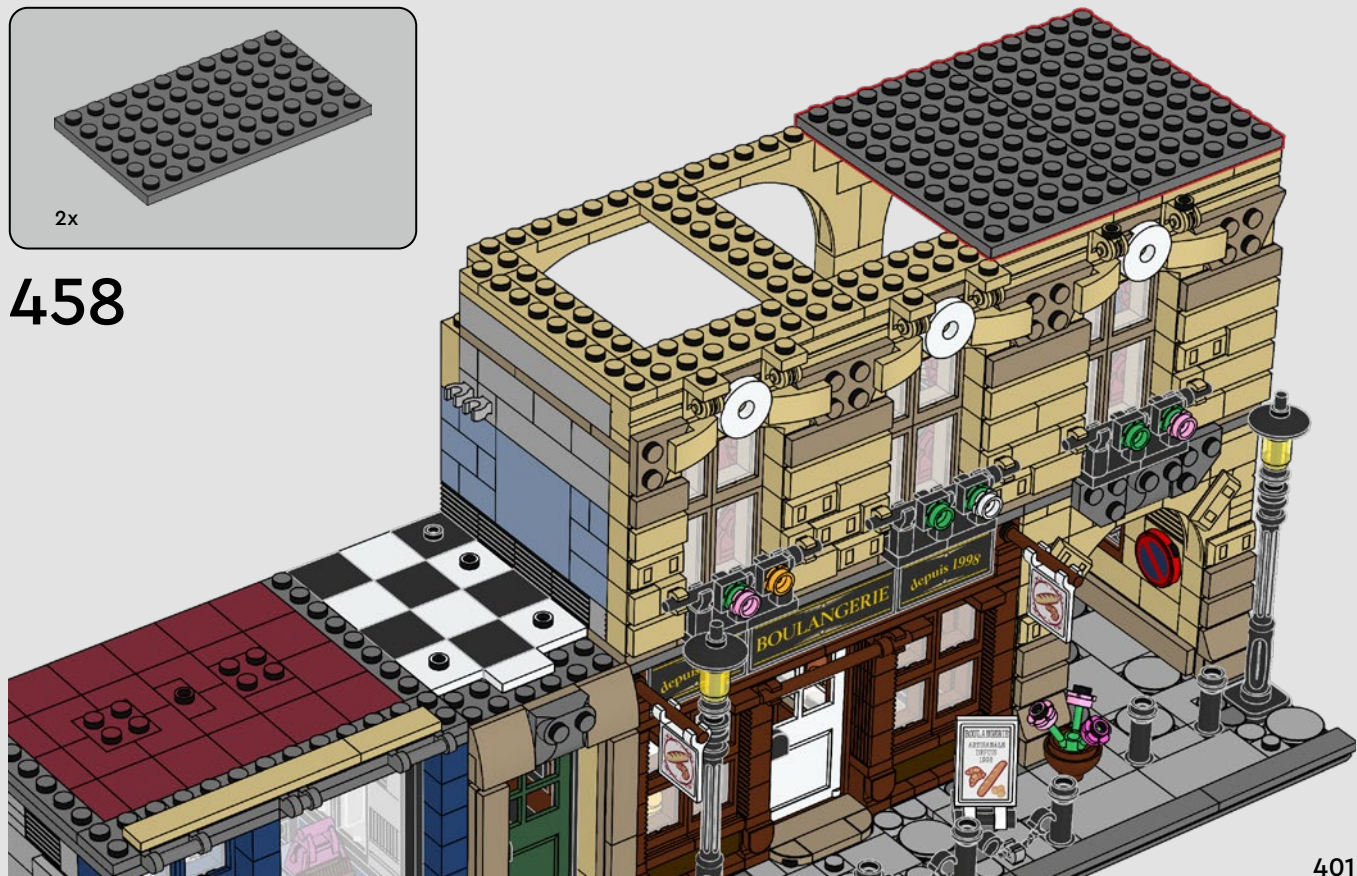



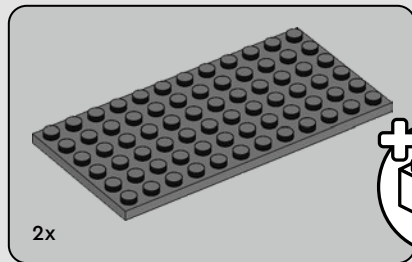

459

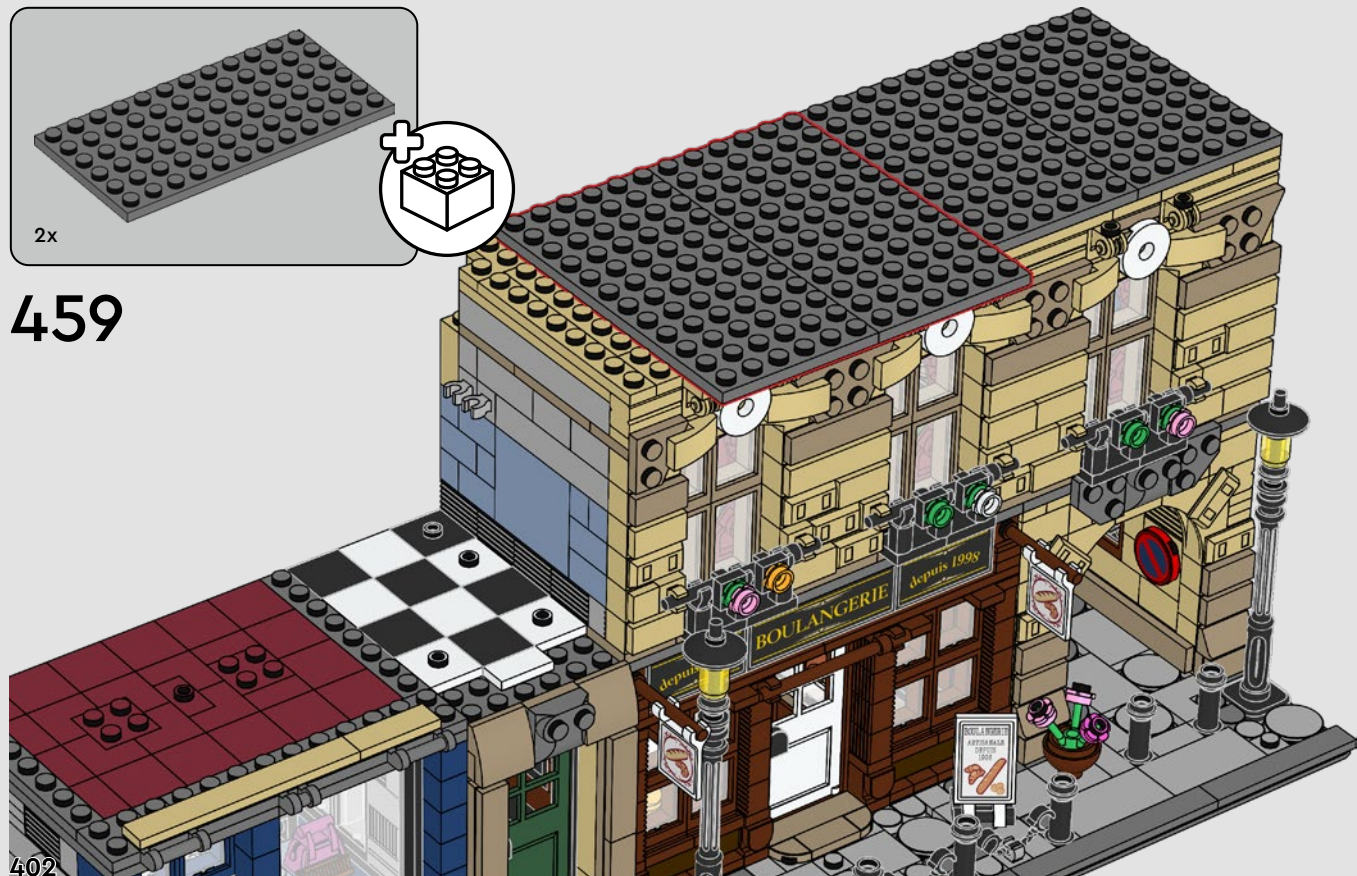



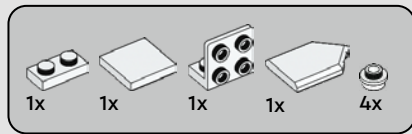

460



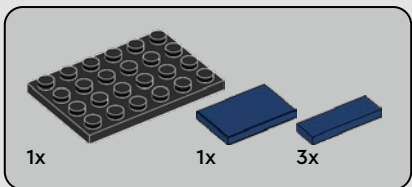
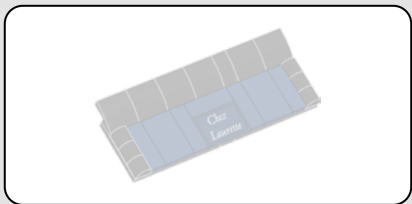

461

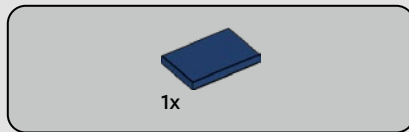
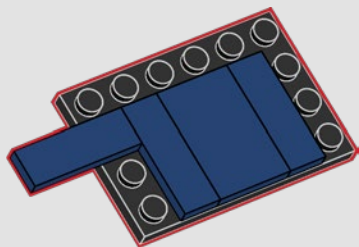

462

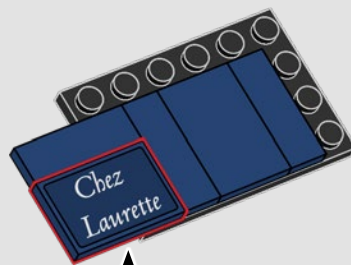



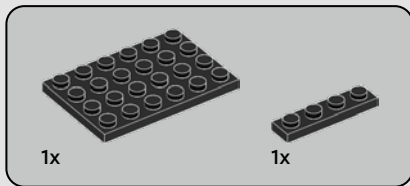

463

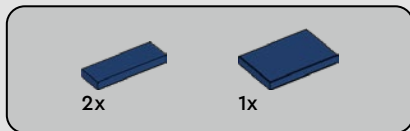
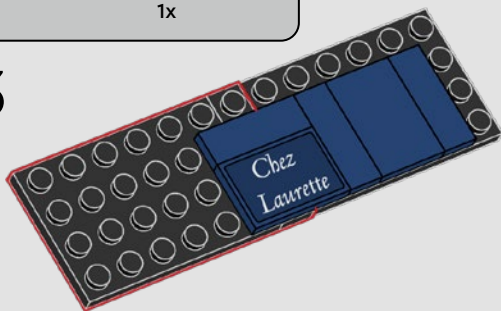

464

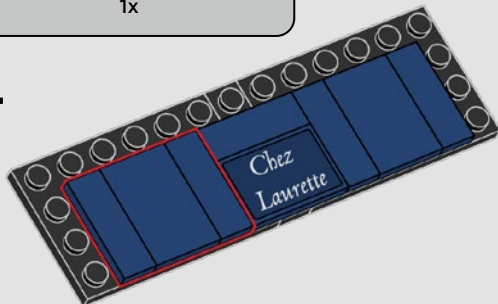

406

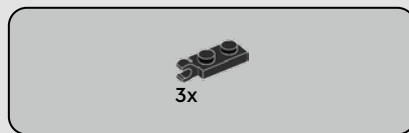

465

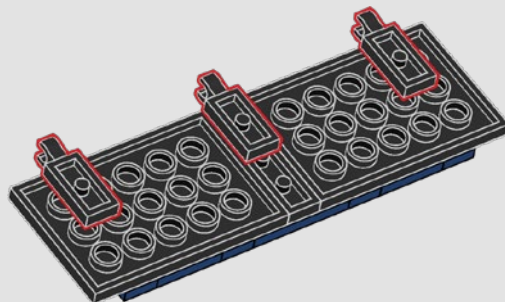



6x

466

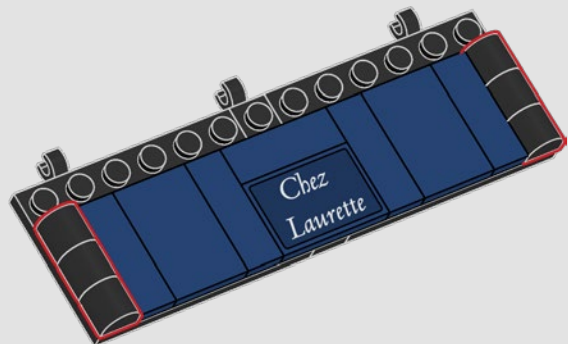

1x



6x

467

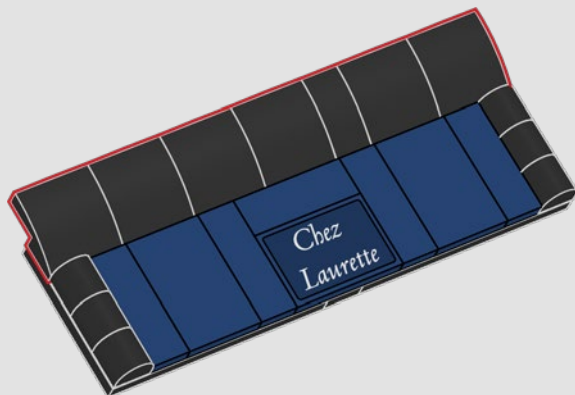

468



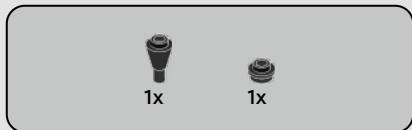

469

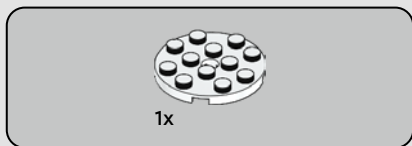

470



471

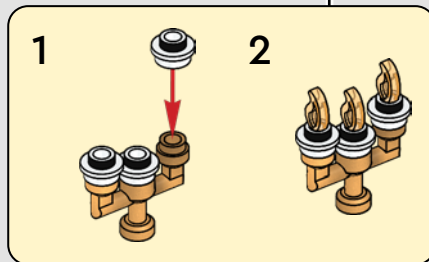
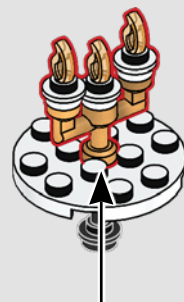



472





1x



1x

# 473



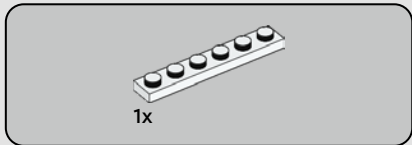

474

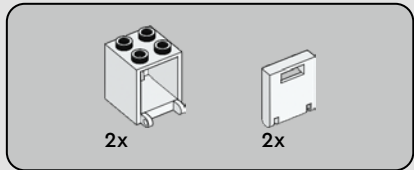
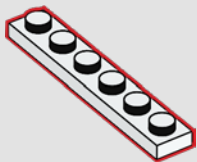

475

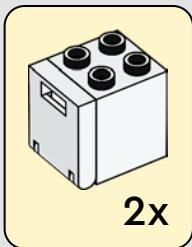
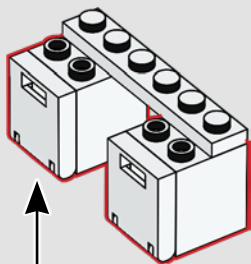

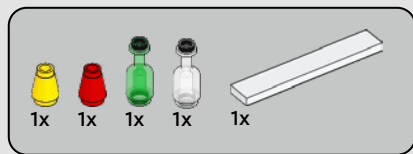

476

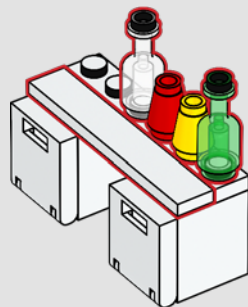



477





1x



1x

478





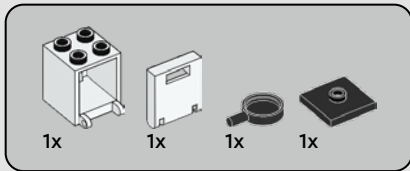

479

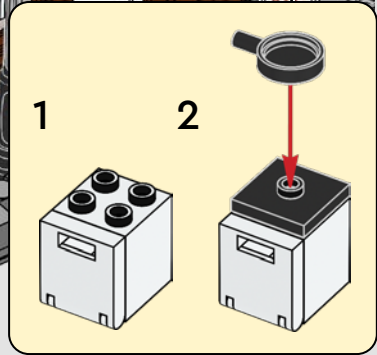

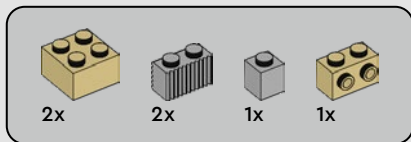

480

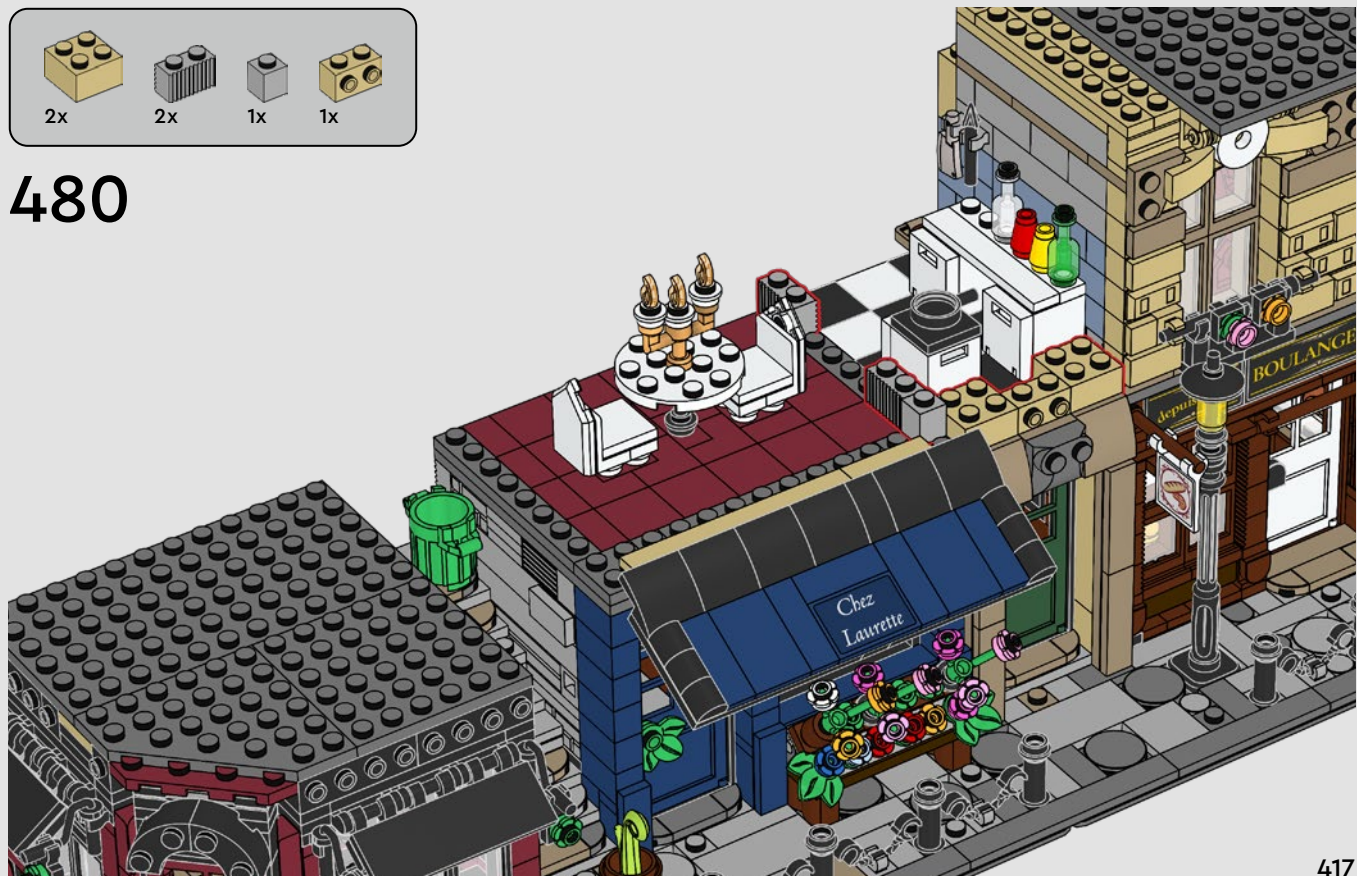





3x



1x



1x

# 481

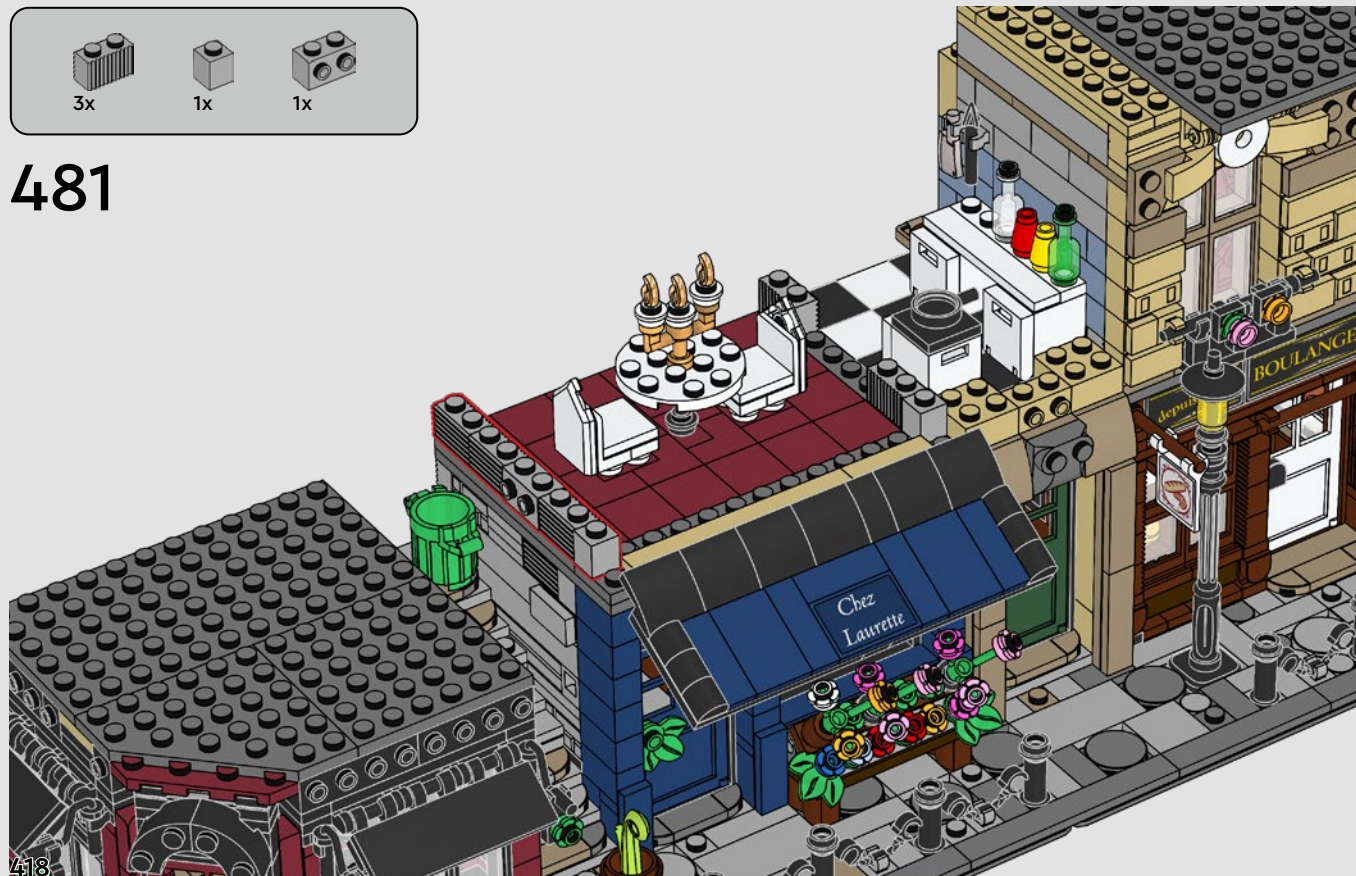



2x

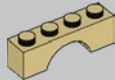

1x

# 482



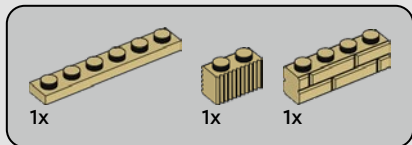

483

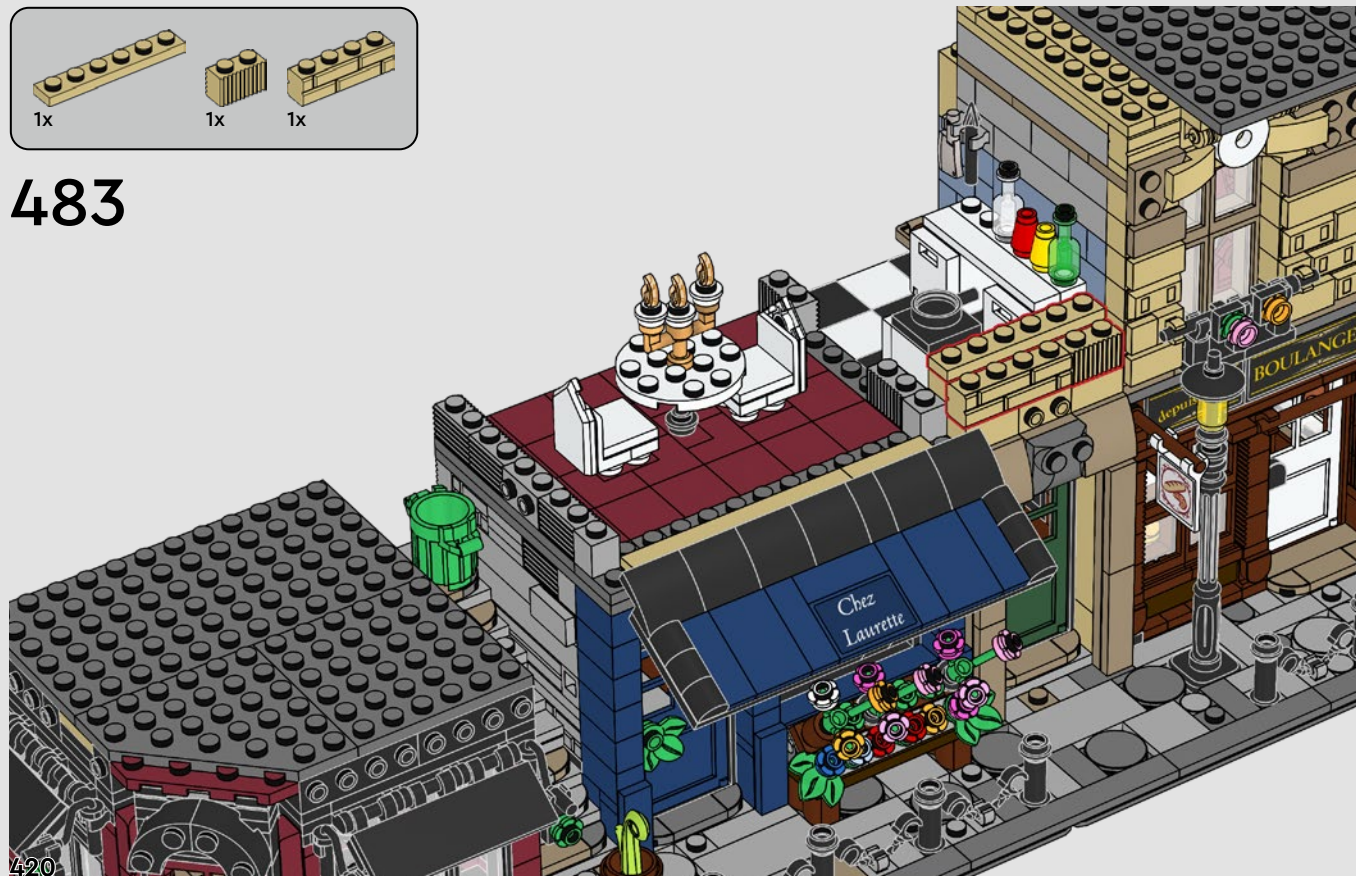



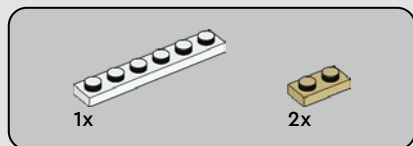

484





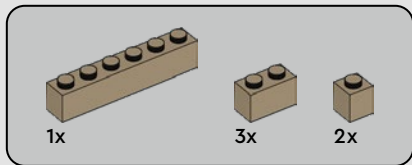

485

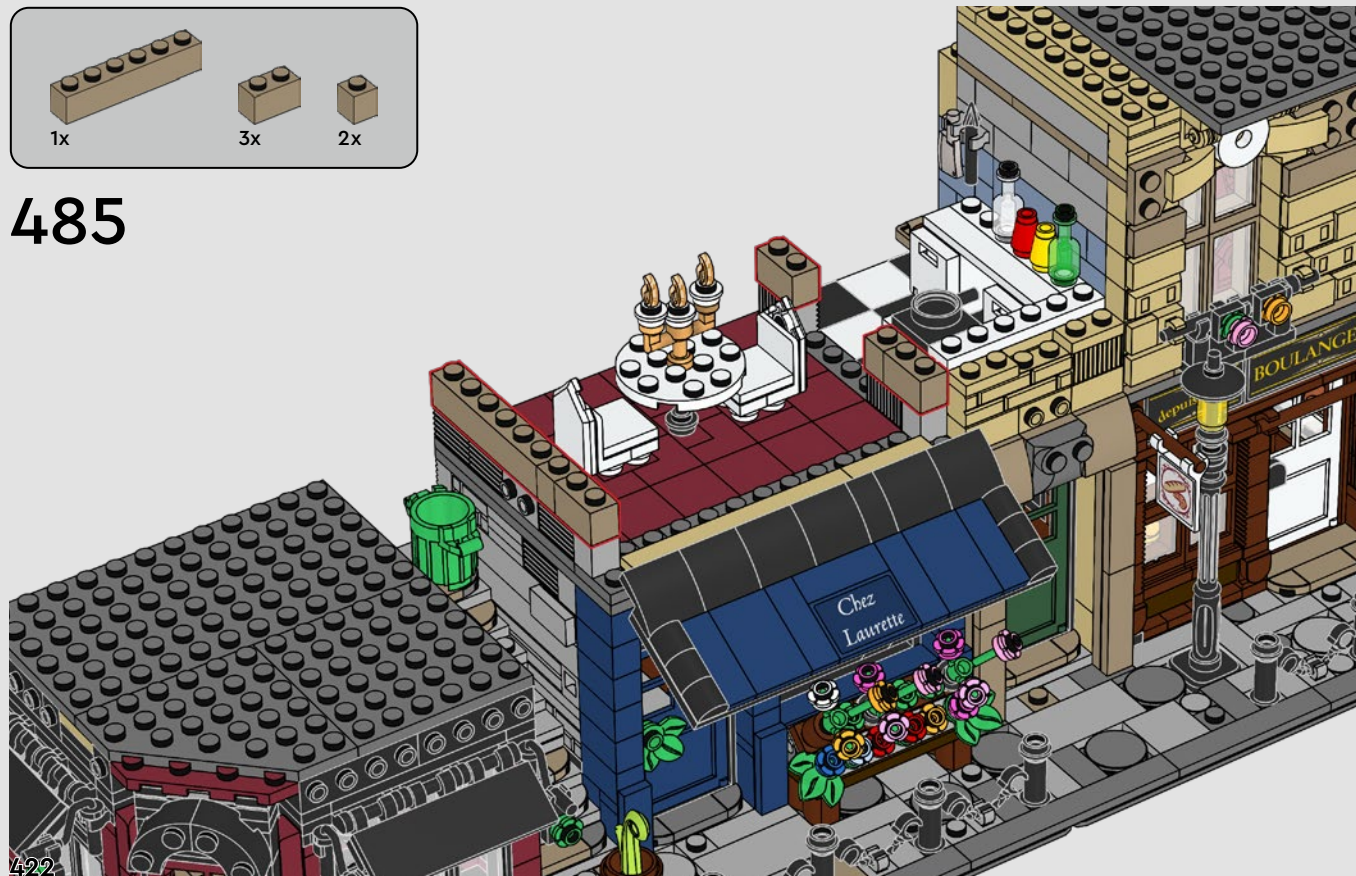

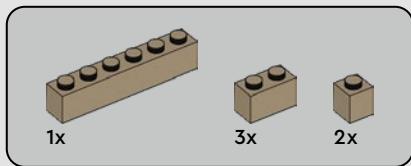

486







3x

487



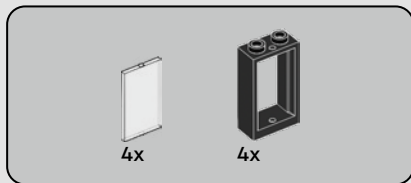

488





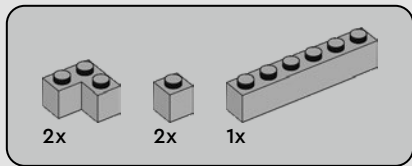

489

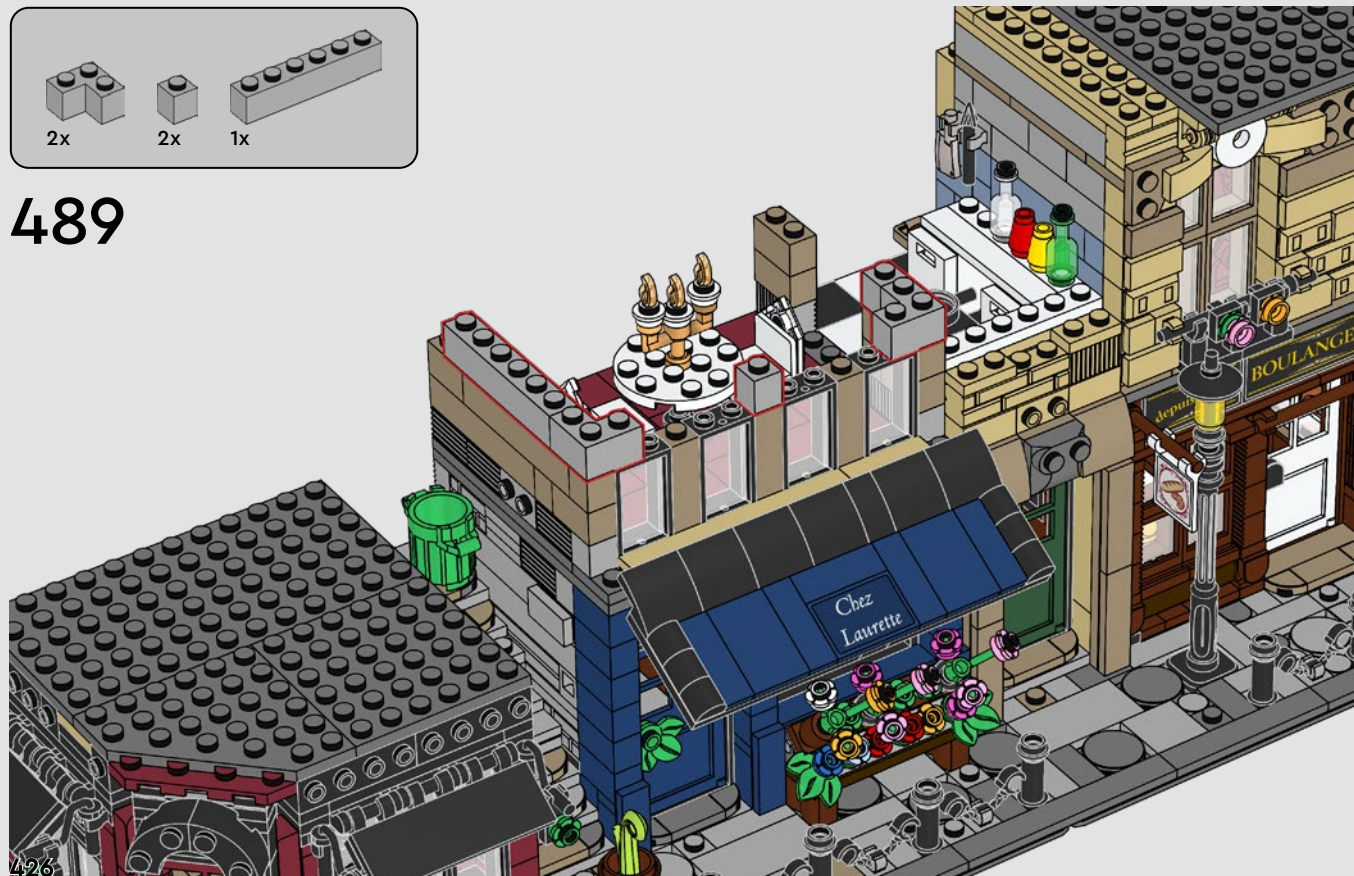

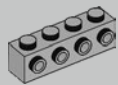

2x



2x



4x

# 490

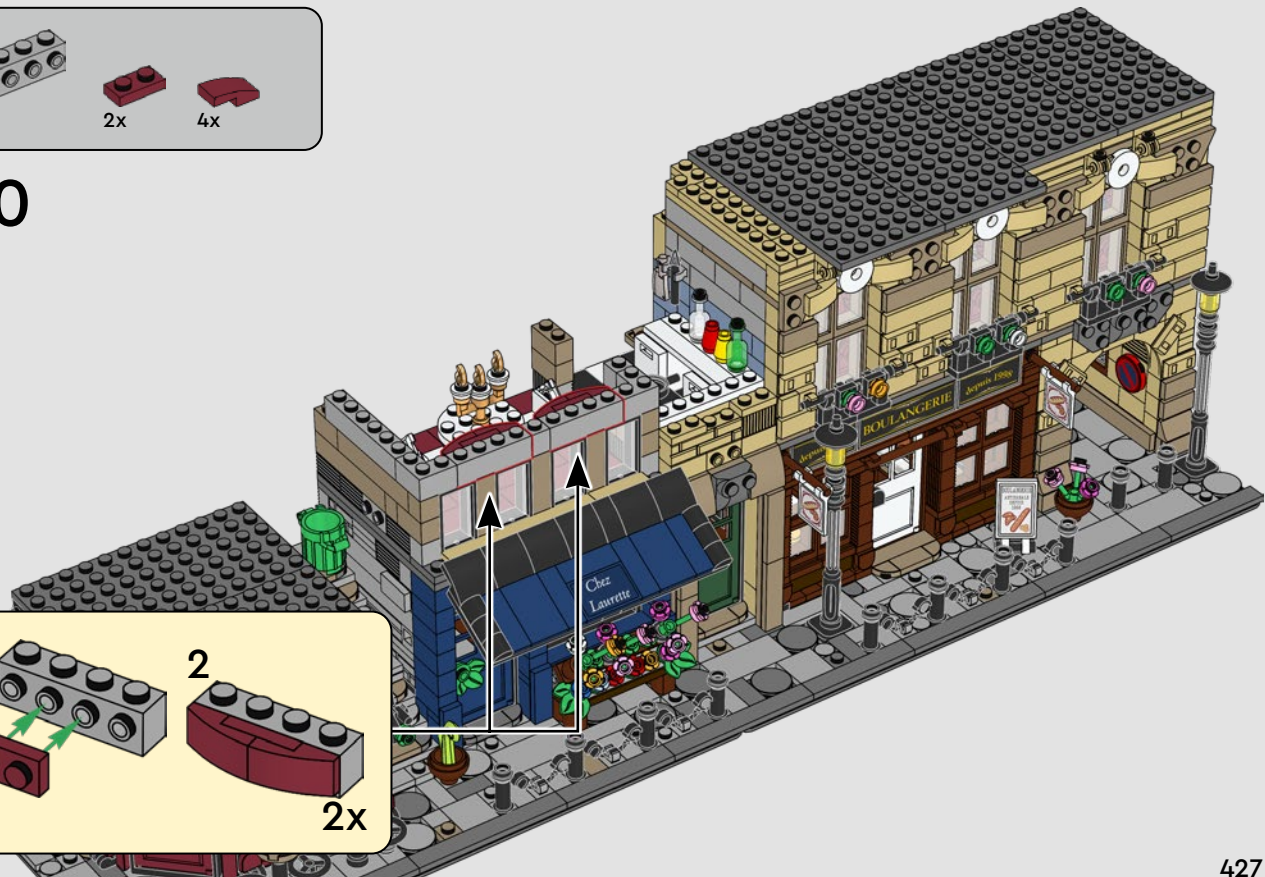

1

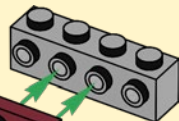

2

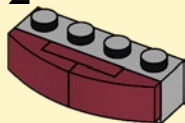

2x

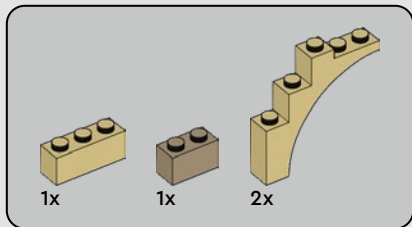

491

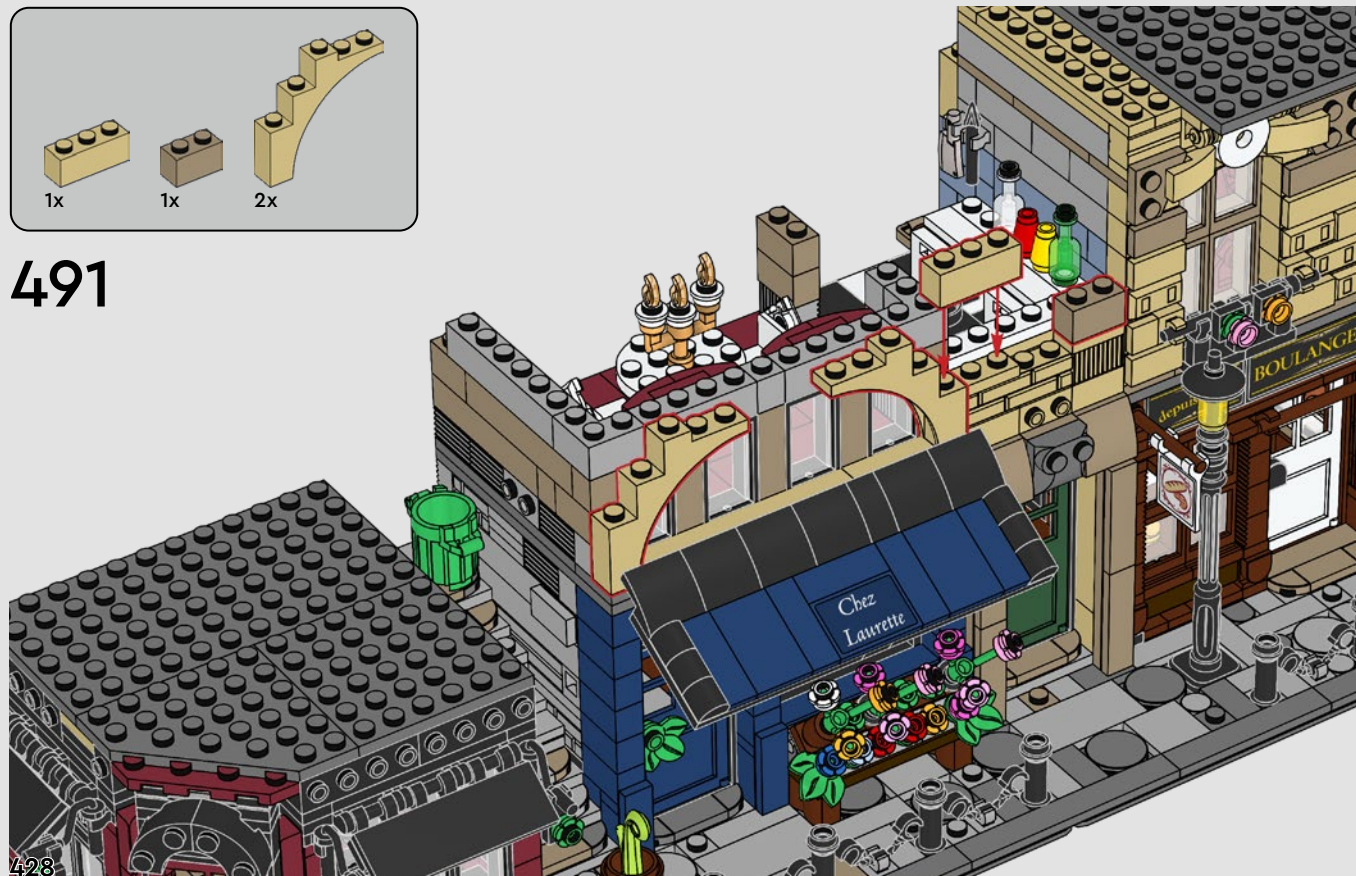



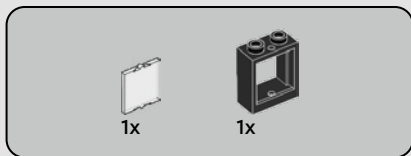

492

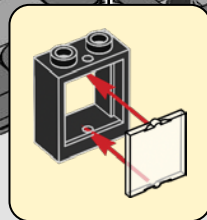



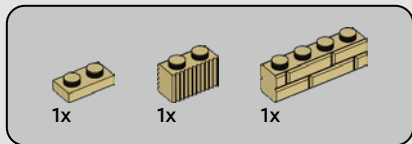

493





1x



1x



1x

# 494





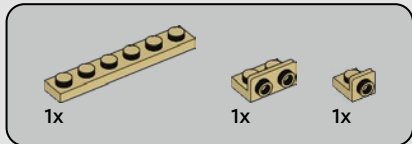

495



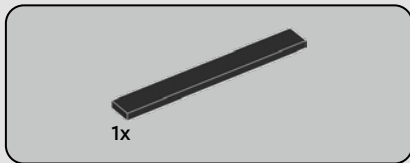

496





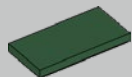

1x



497

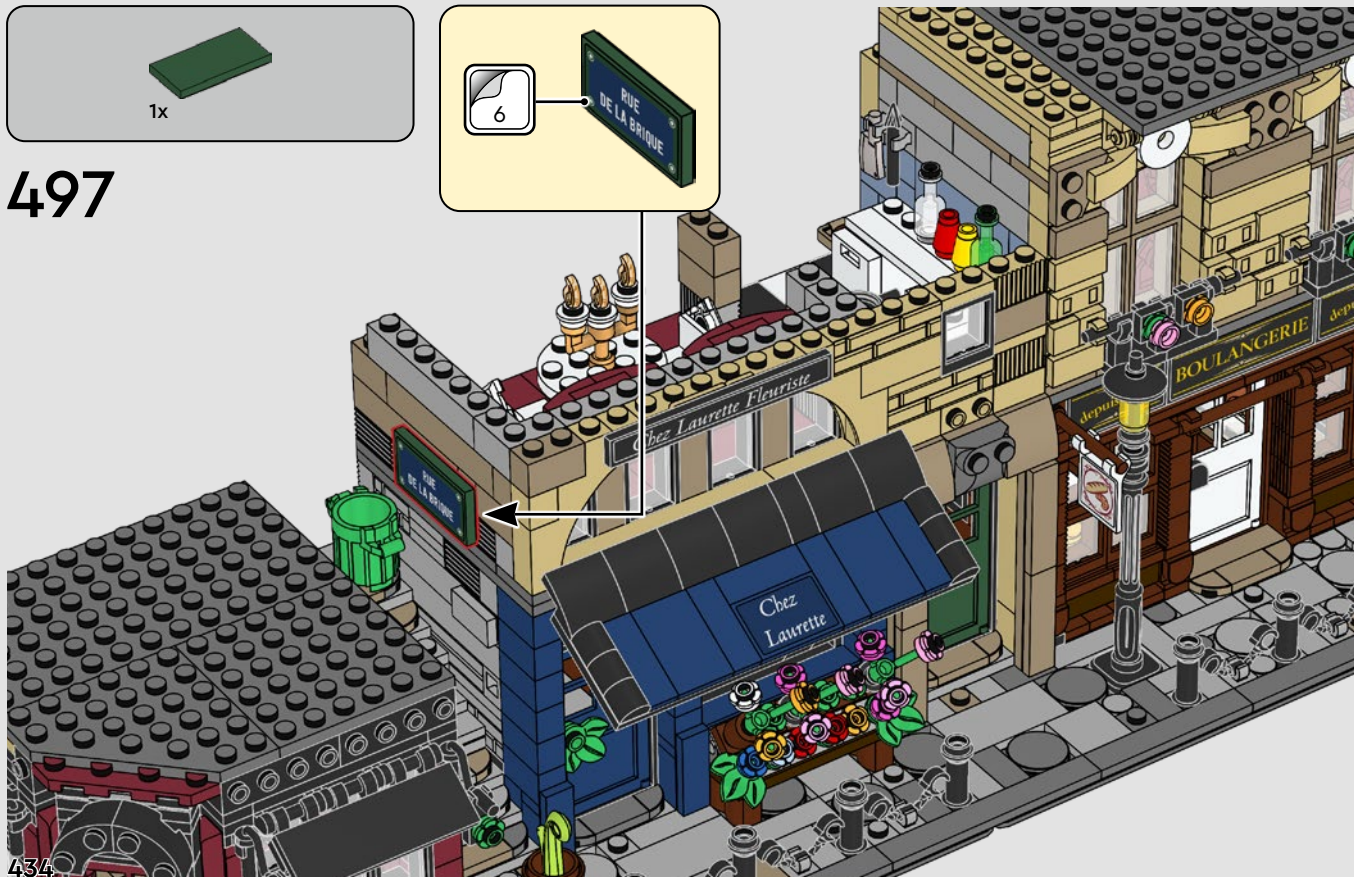

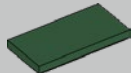

1x

498





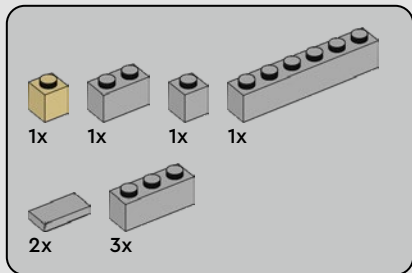

499





6x

500







1x



1x

# 501

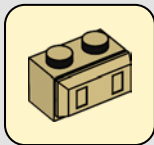
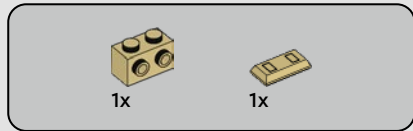
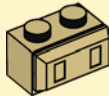

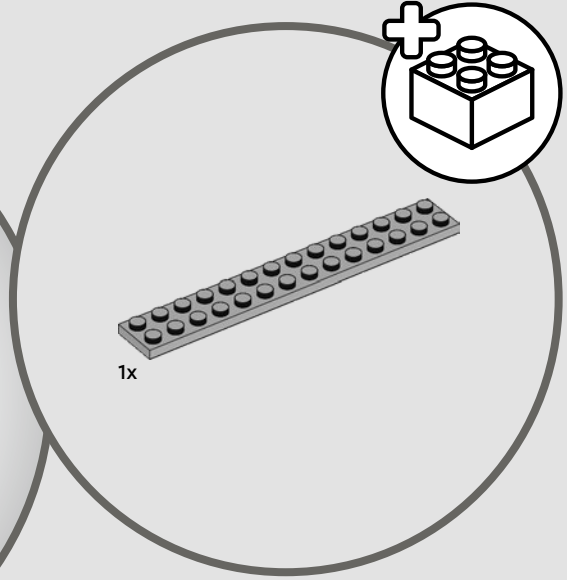

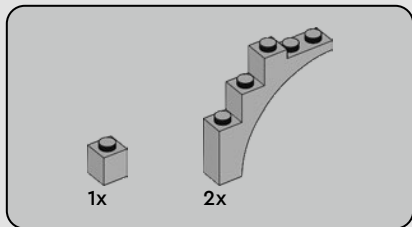

502

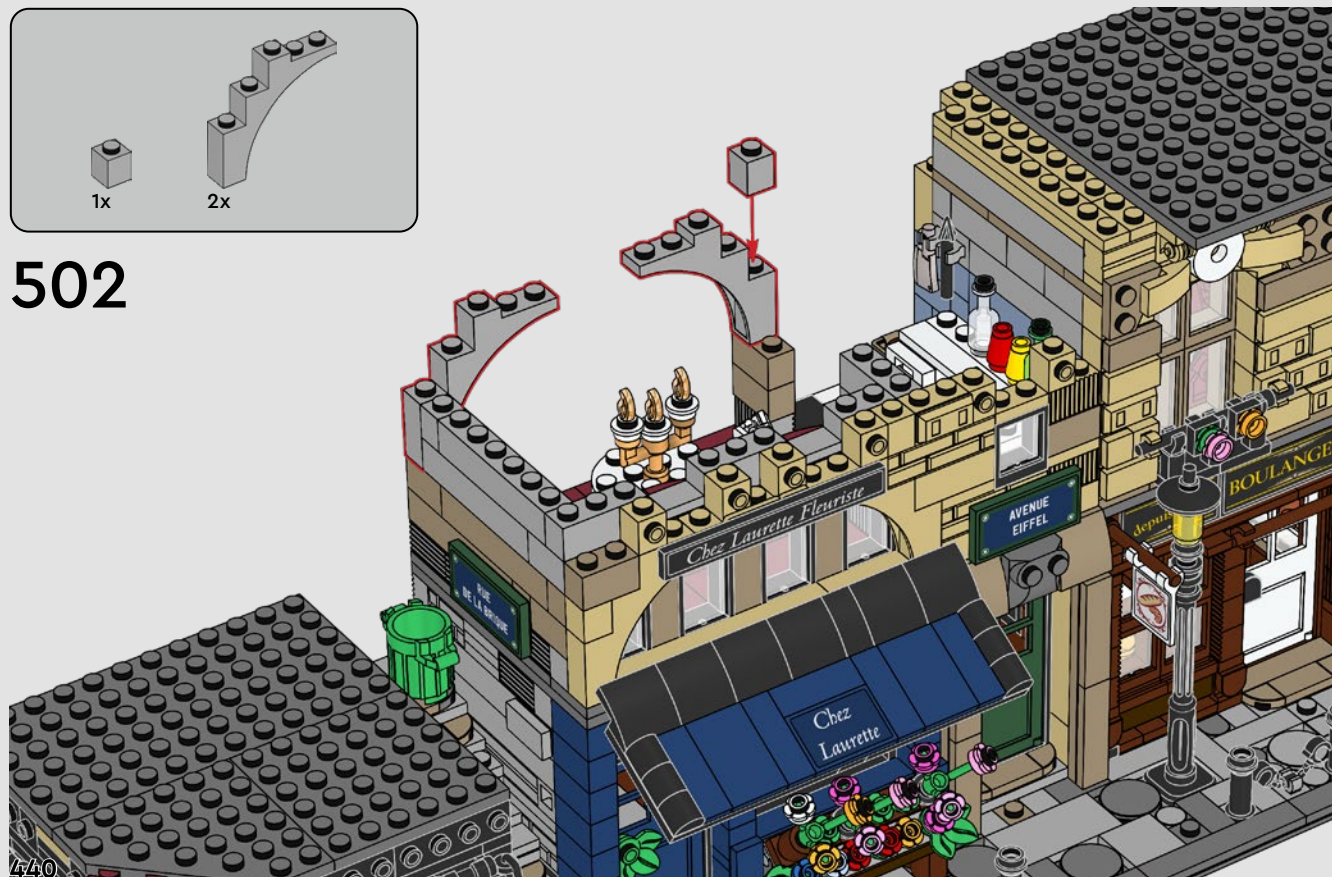







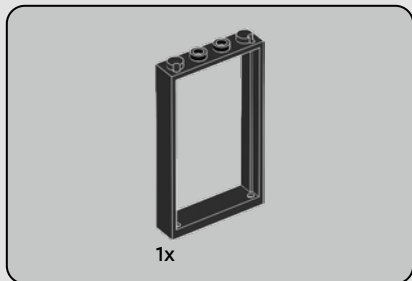

504



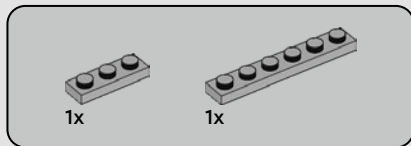

505

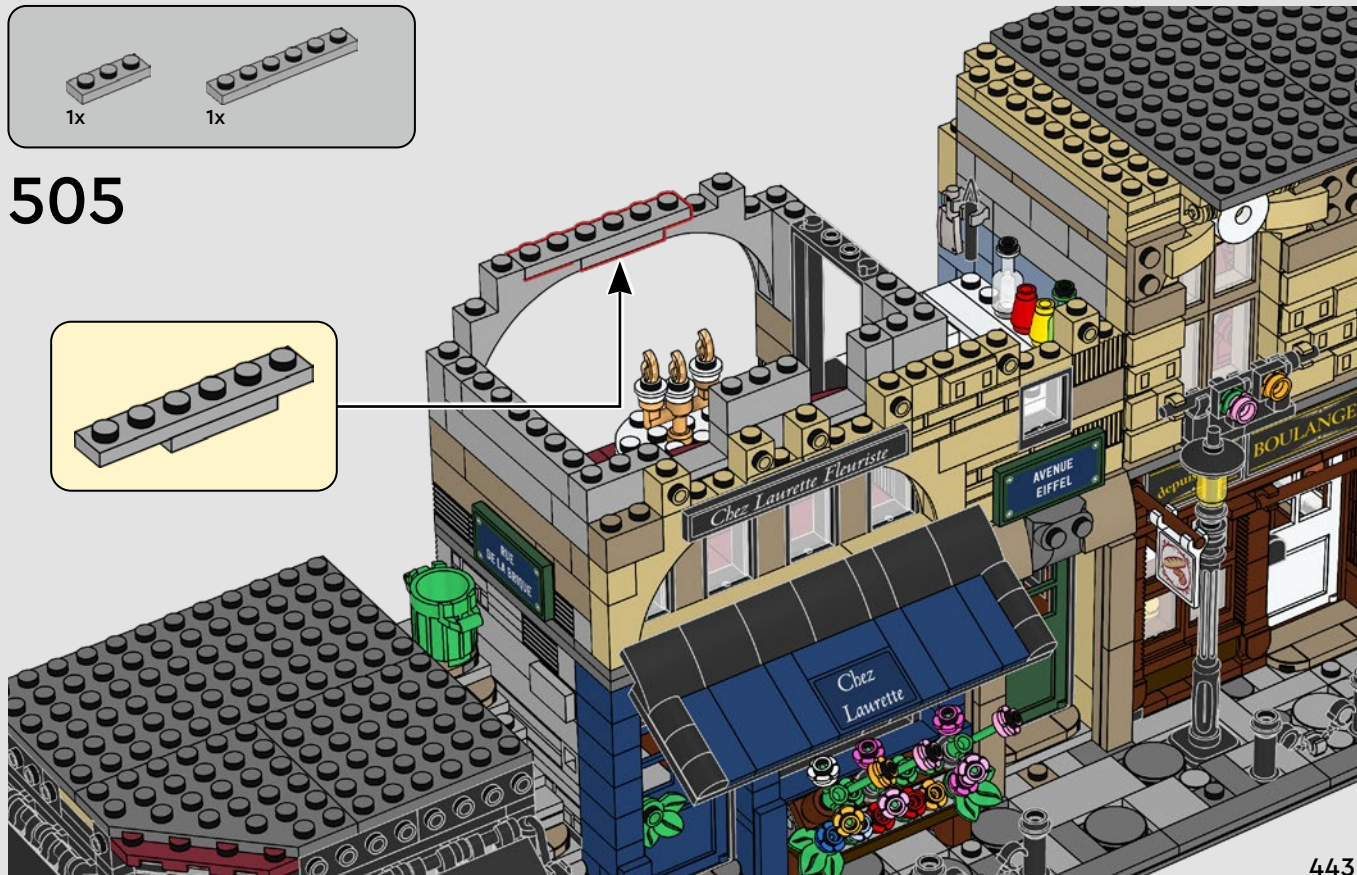
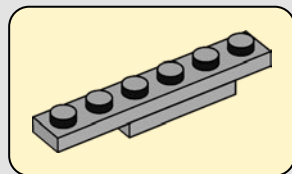

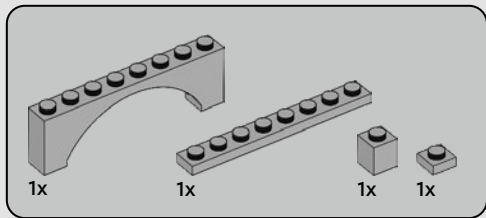

506

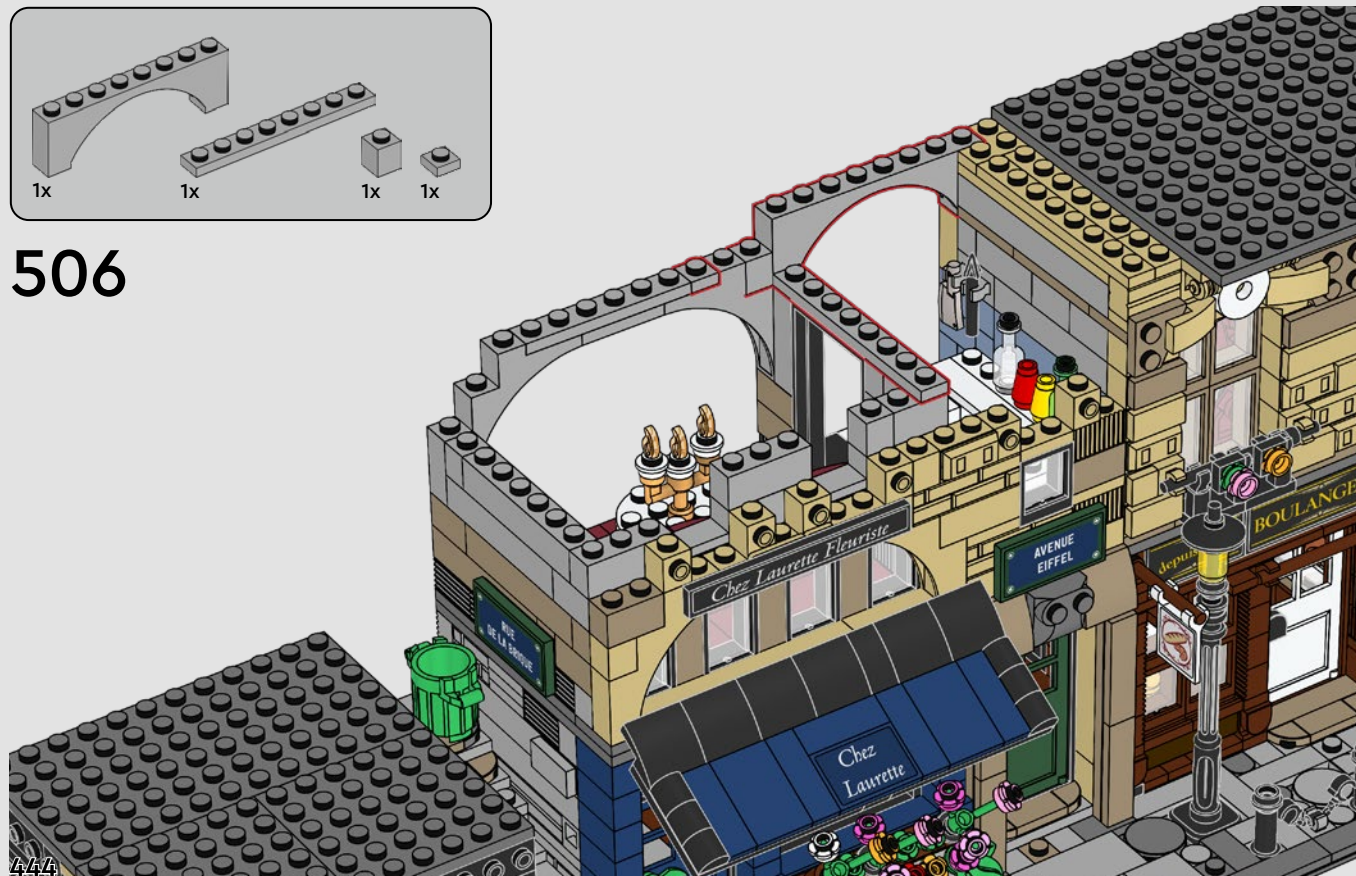





1x



2x

# 507





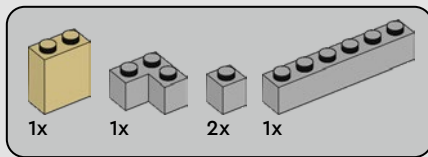

508





1x



1x

# 509

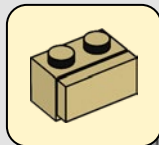



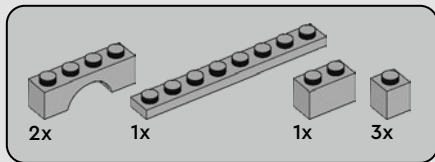

510

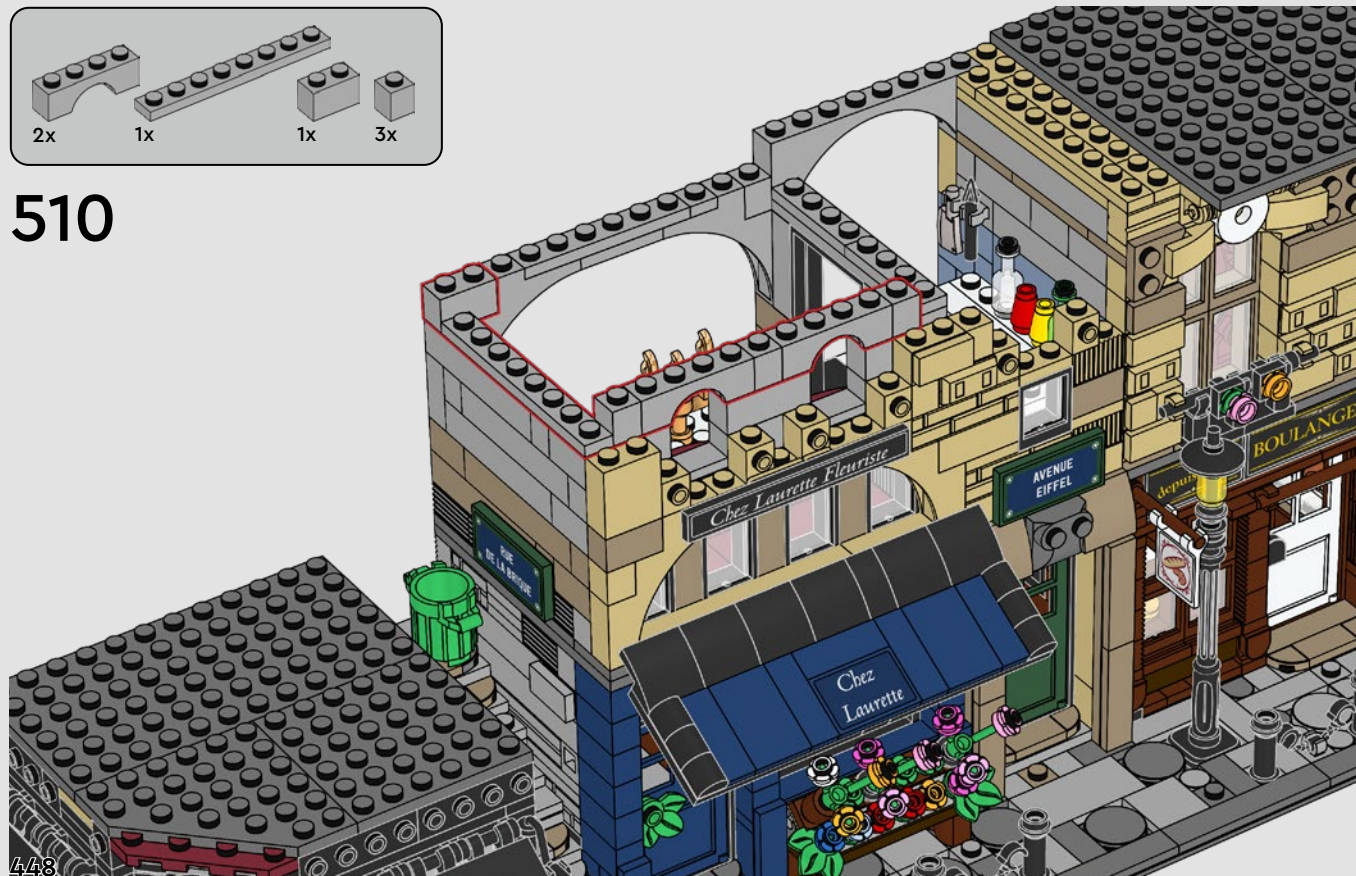



2x

511





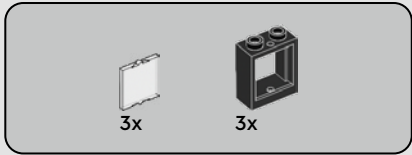

512

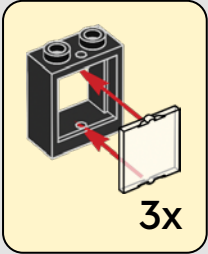



6x

513







2x

514



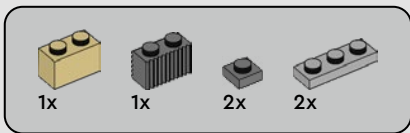

515

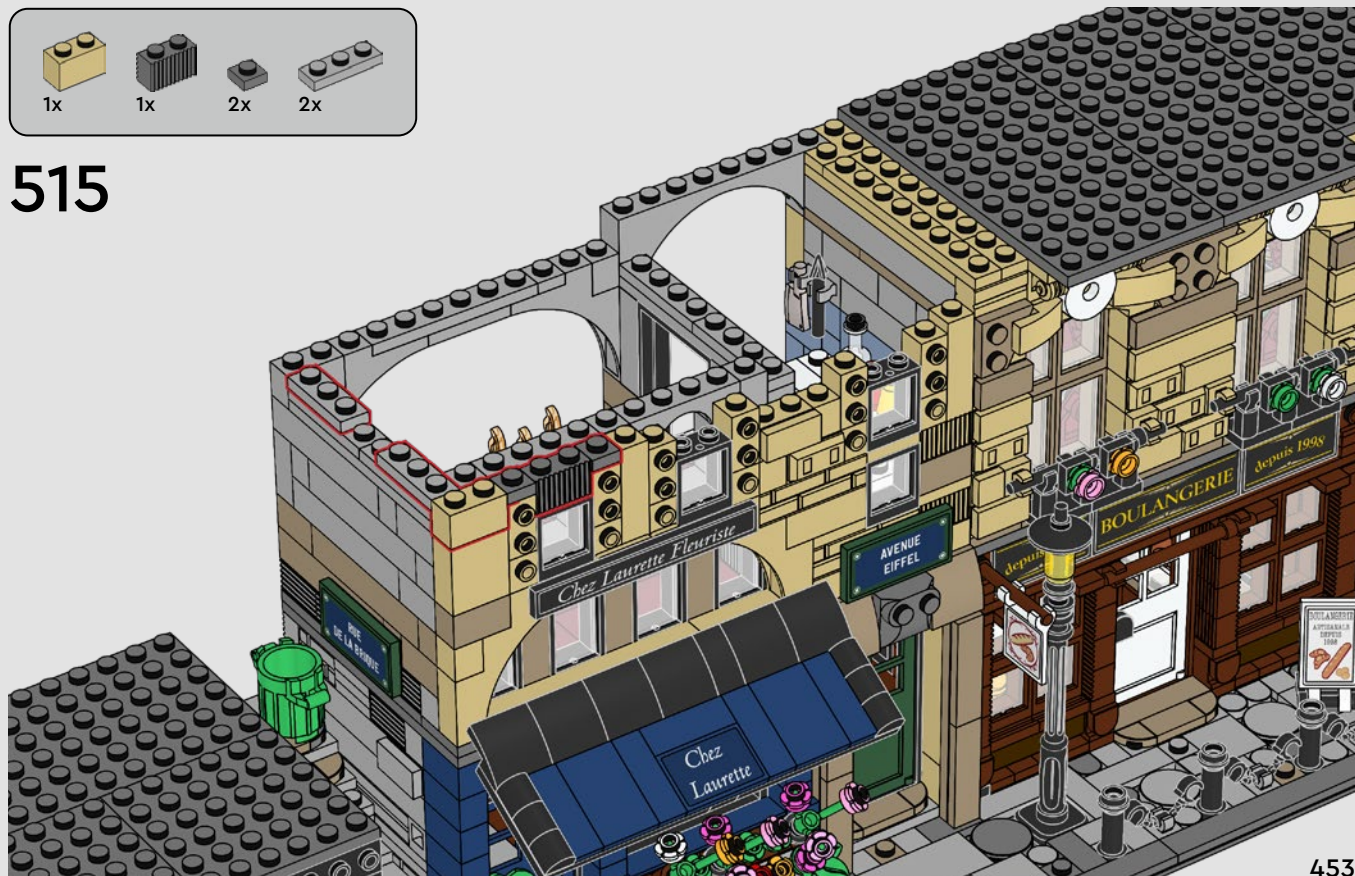





2x



4x



1x



1x

# 516



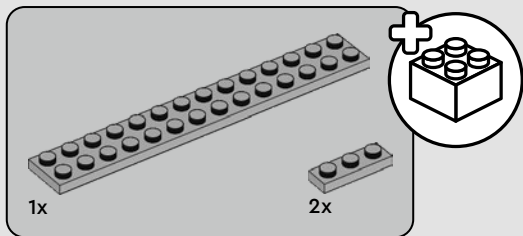

517

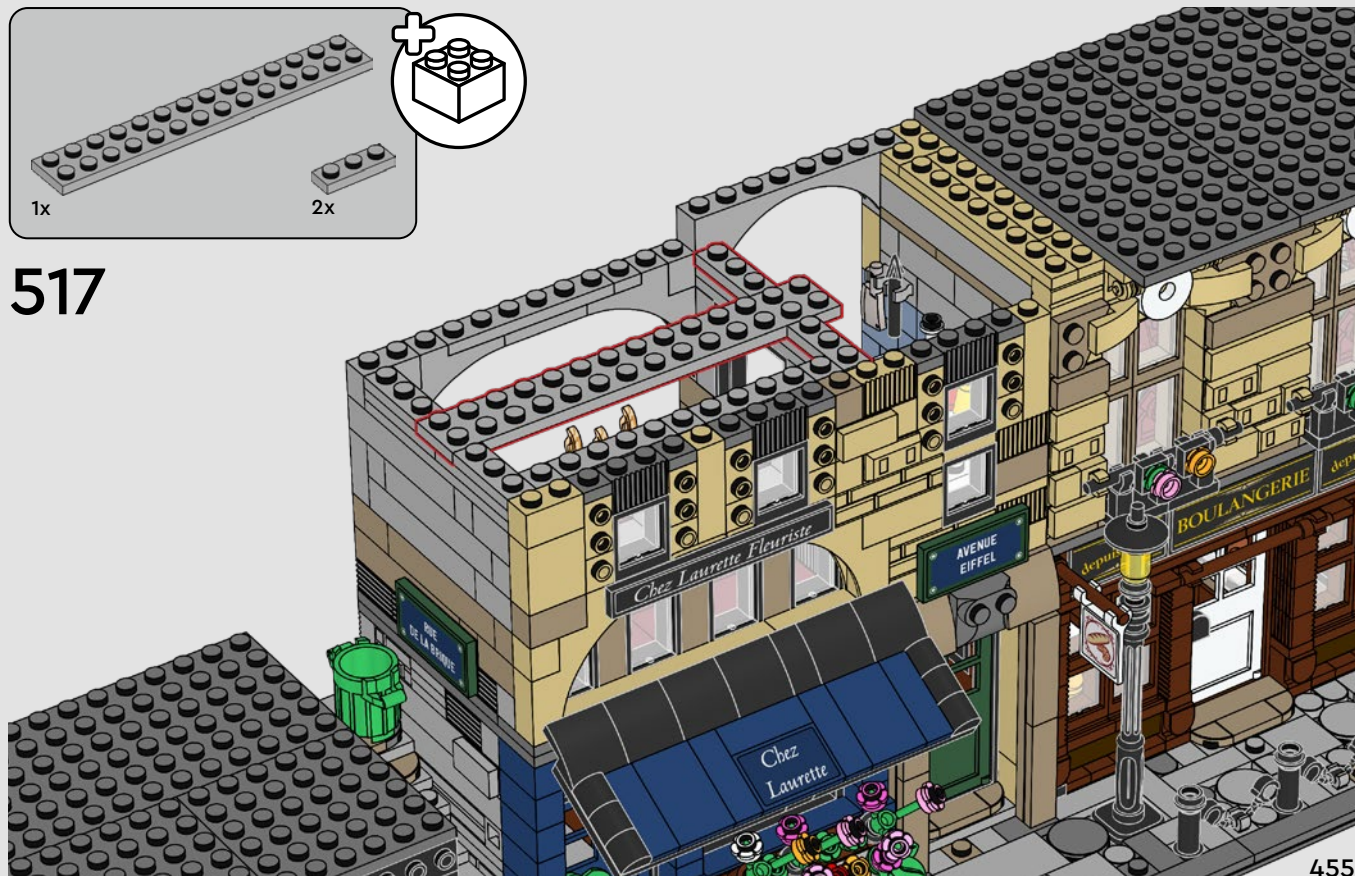



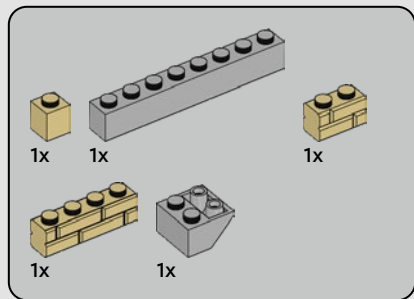

518

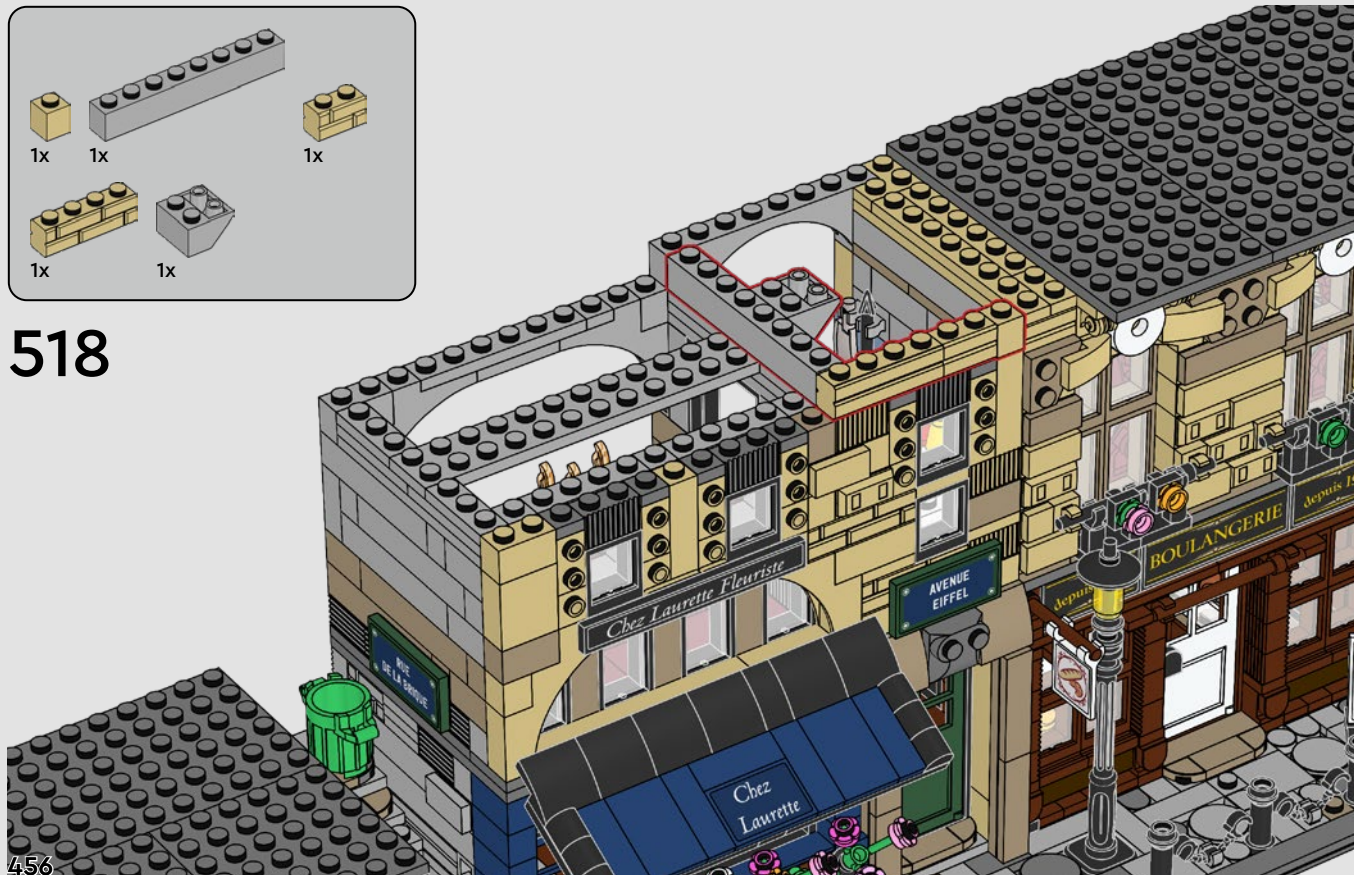

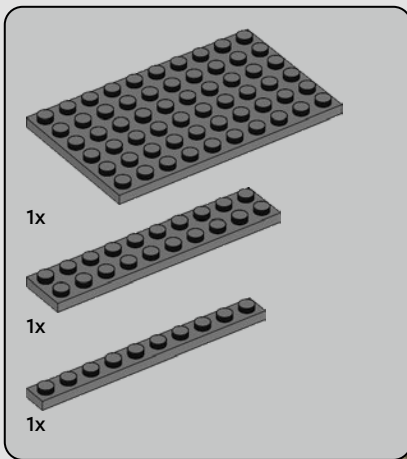

519

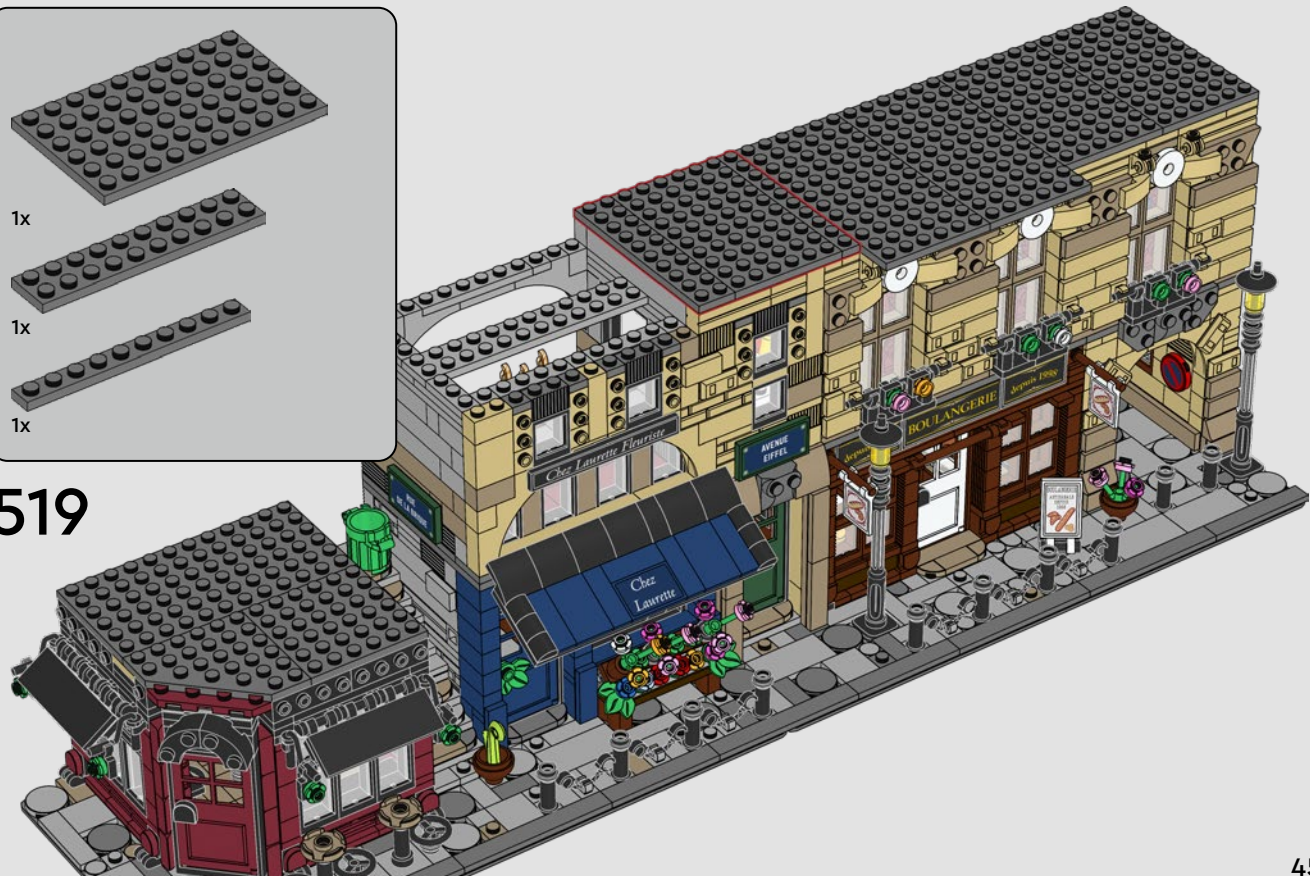



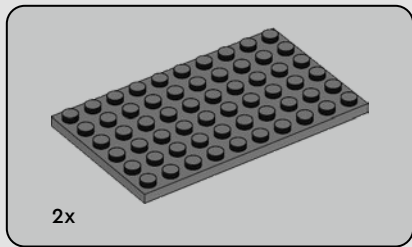

520

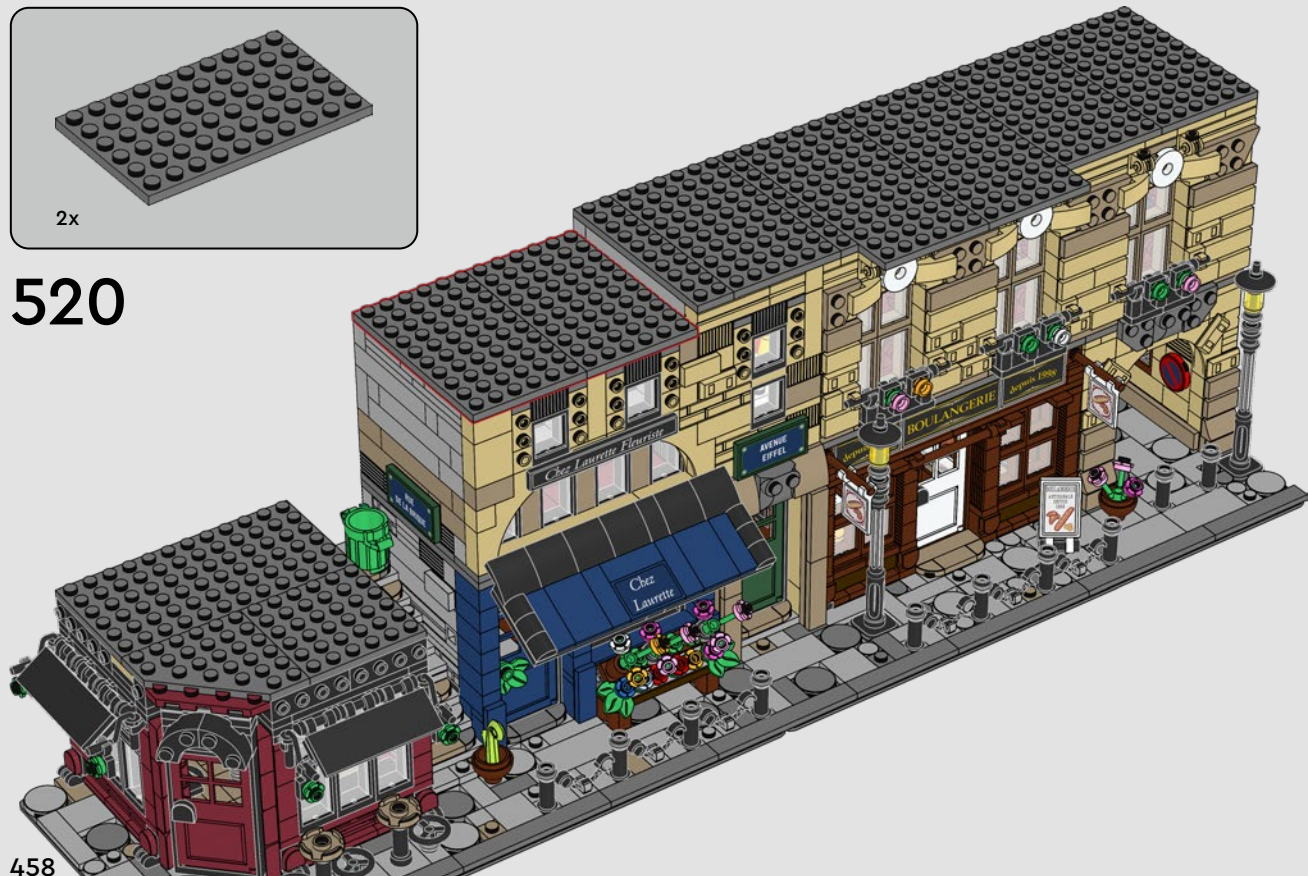



6x



6x

# 521





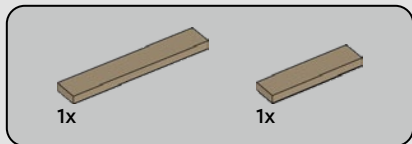

522





7x



8x

# 523





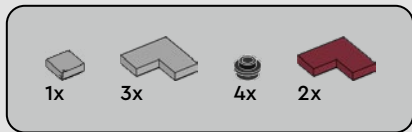

524





4x

525





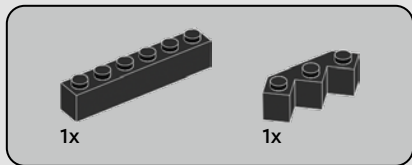

526



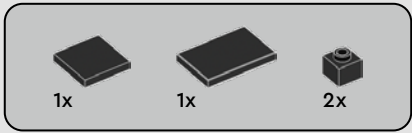

527







2x



2x

# 528



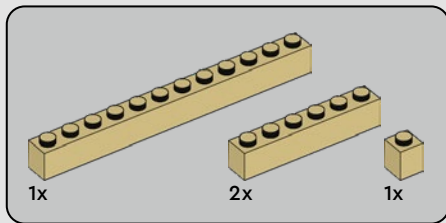

529



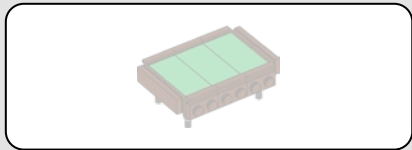

530

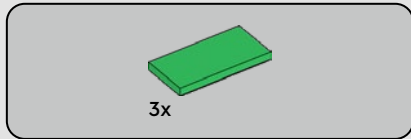
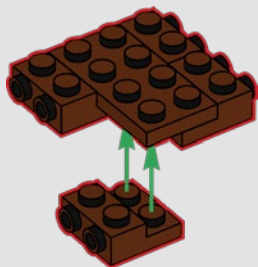

531

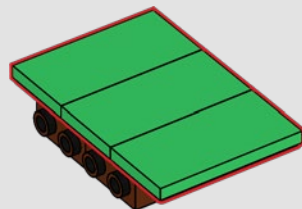



4x

532

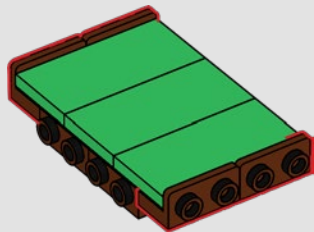

1x



4x



2x

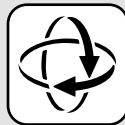

533

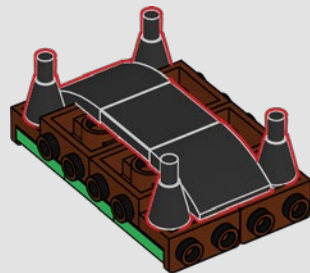



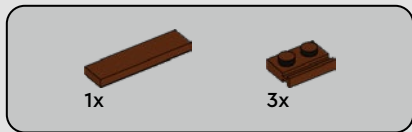

534

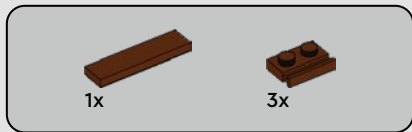
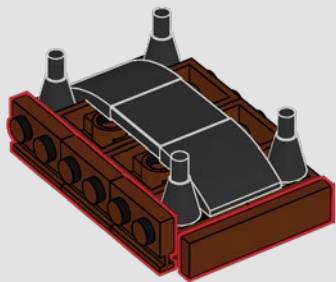

535

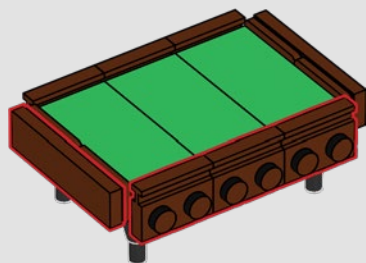

536



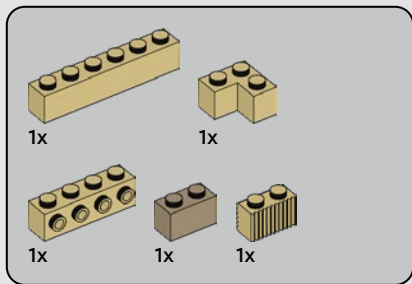

537



472



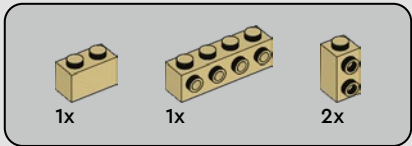

538





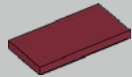

2x

539



2x



2x

540



2x



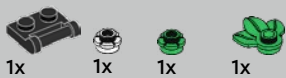

541

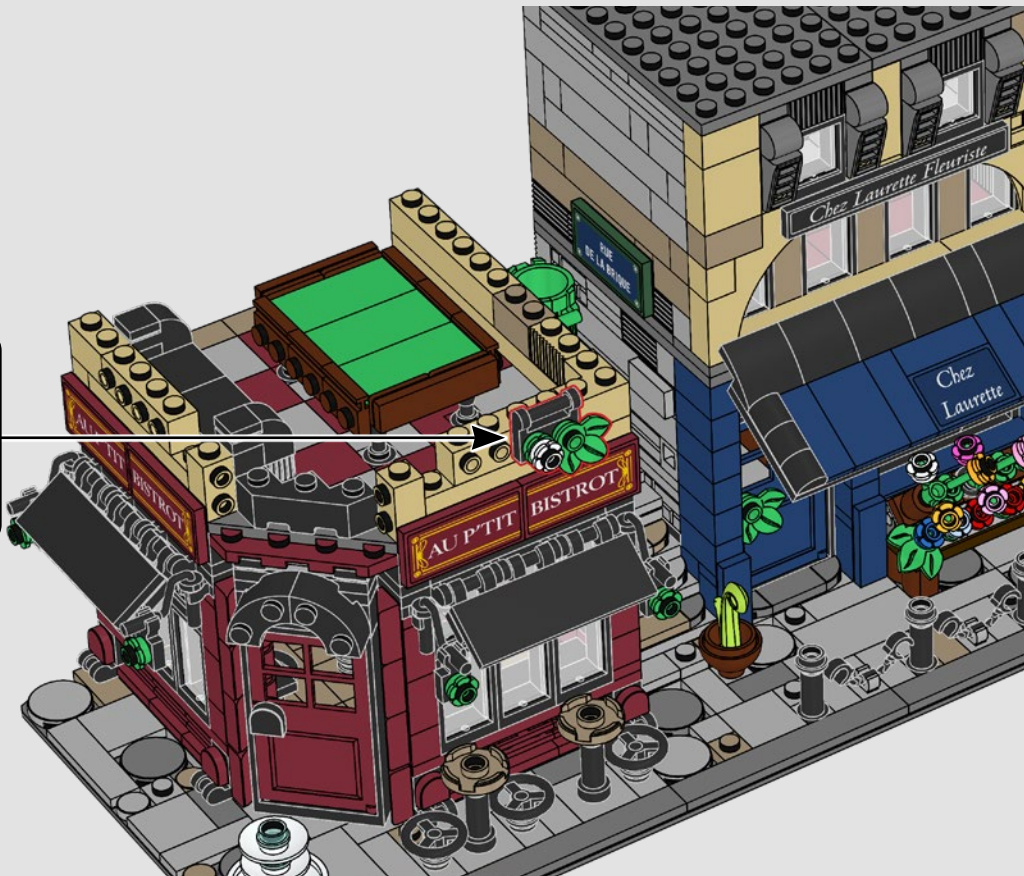
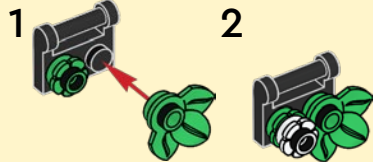





1x



1x



1x



1x

# 542

1



2







1x



1x



1x



1x

# 543

1



2

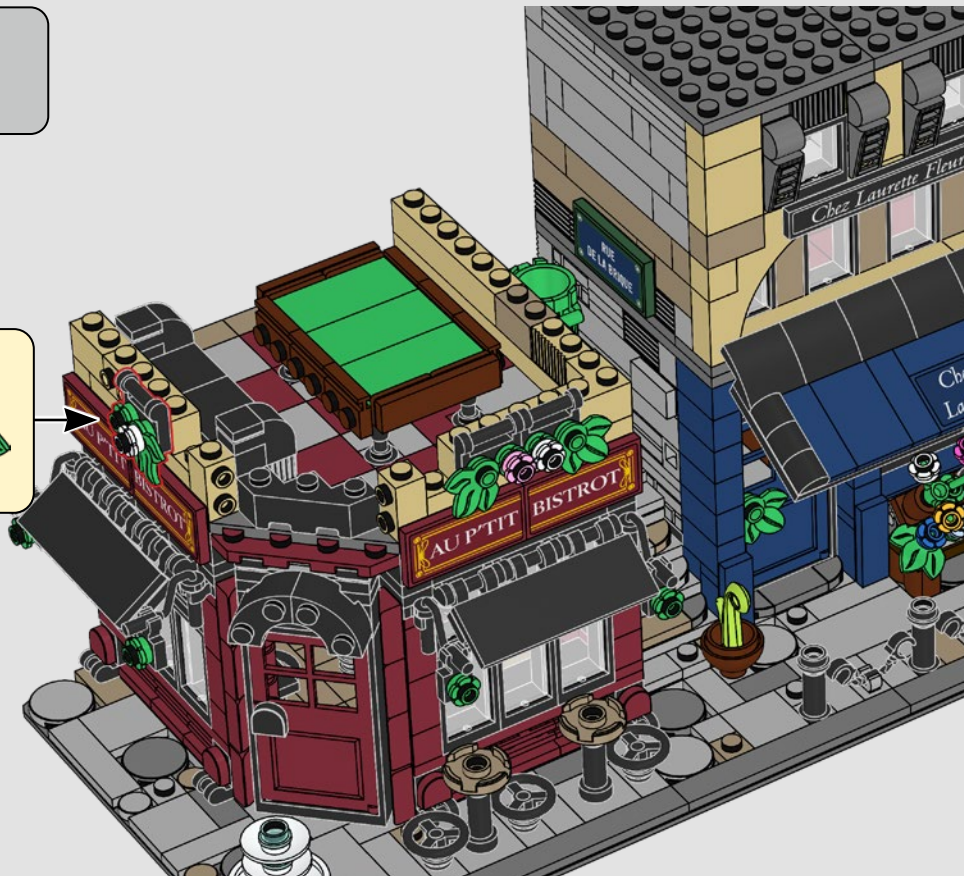



1x



1x



1x



1x

# 544

1

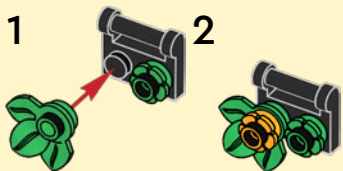

2





2x

545



480



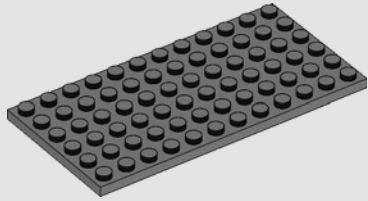
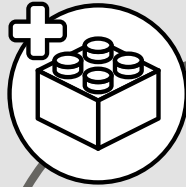

1x



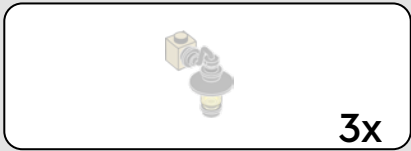

546

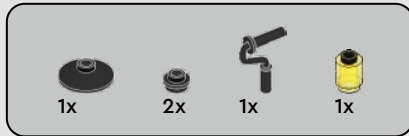
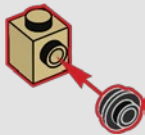

547

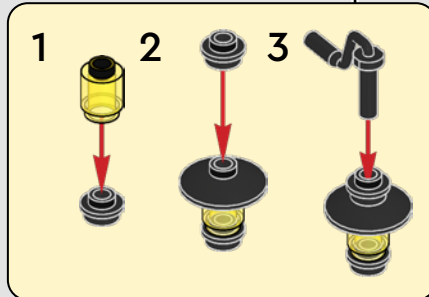

3x



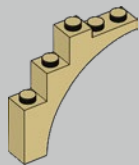

2x

549

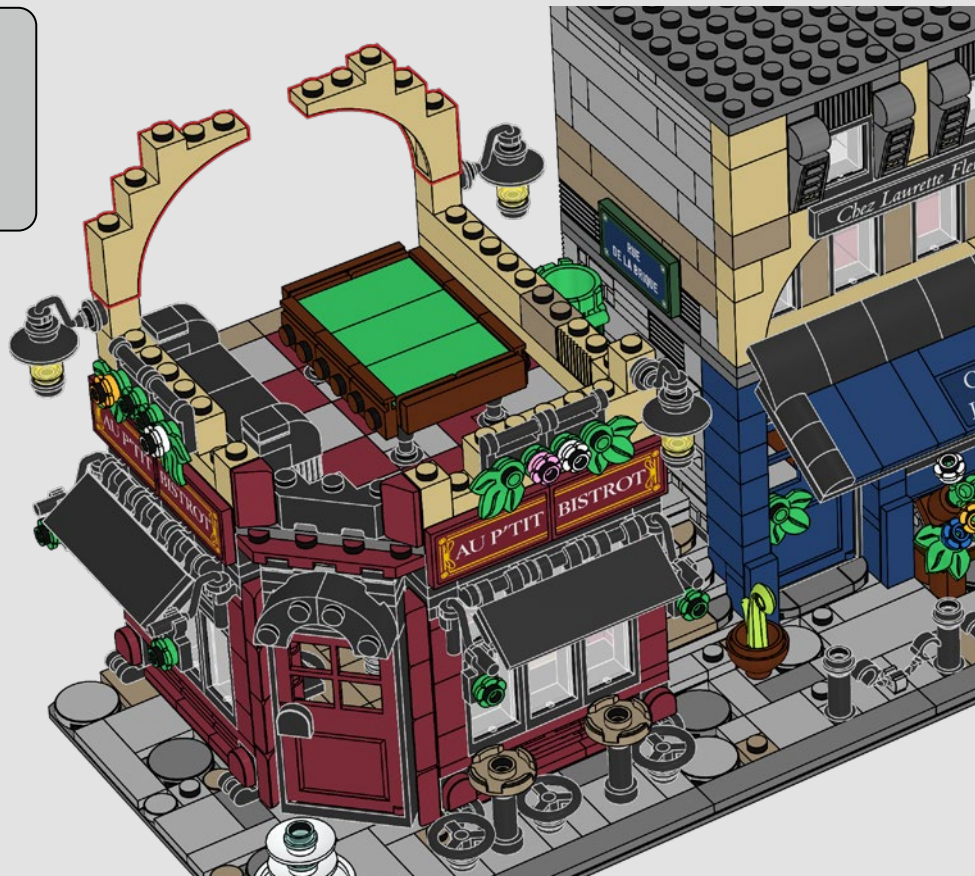

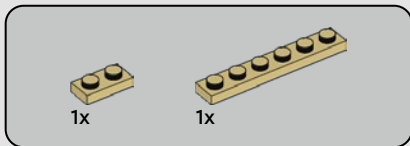

550

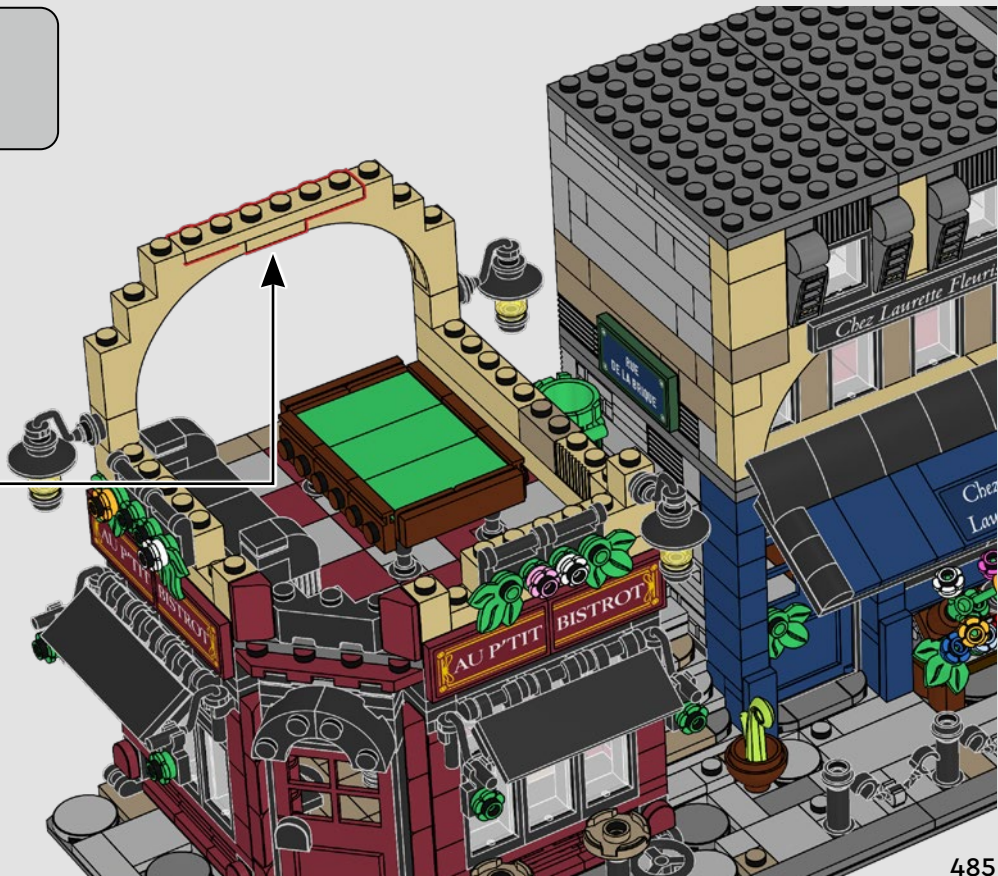
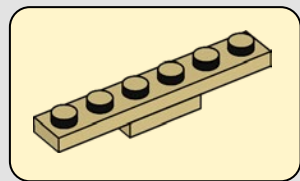





1x



2x

# 551

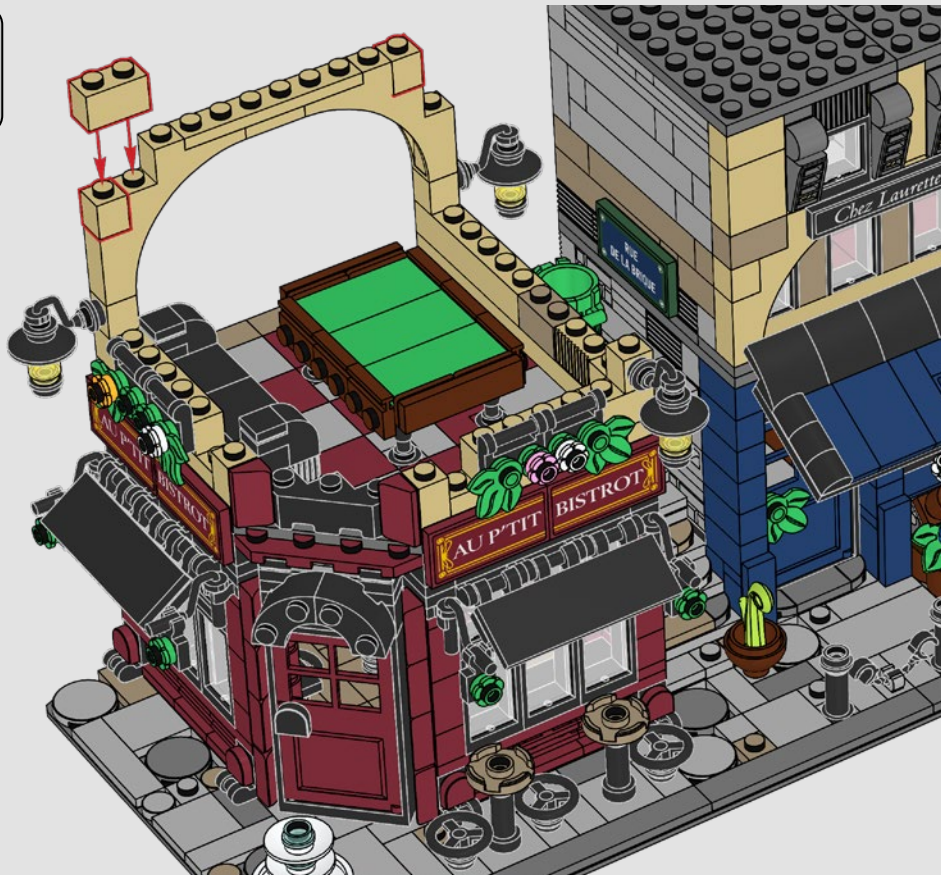



1x



1x

552

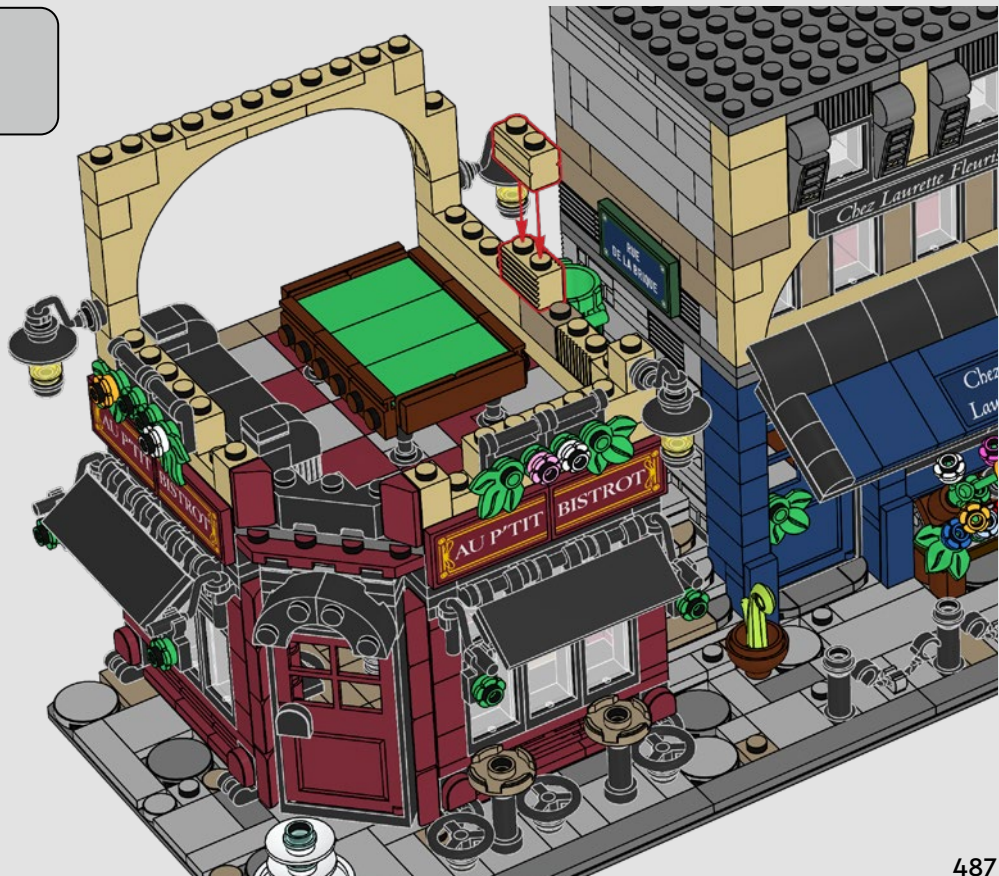



1x



1x

# 553





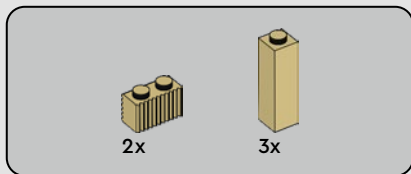

554





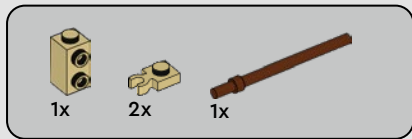

555

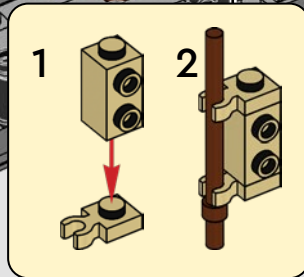
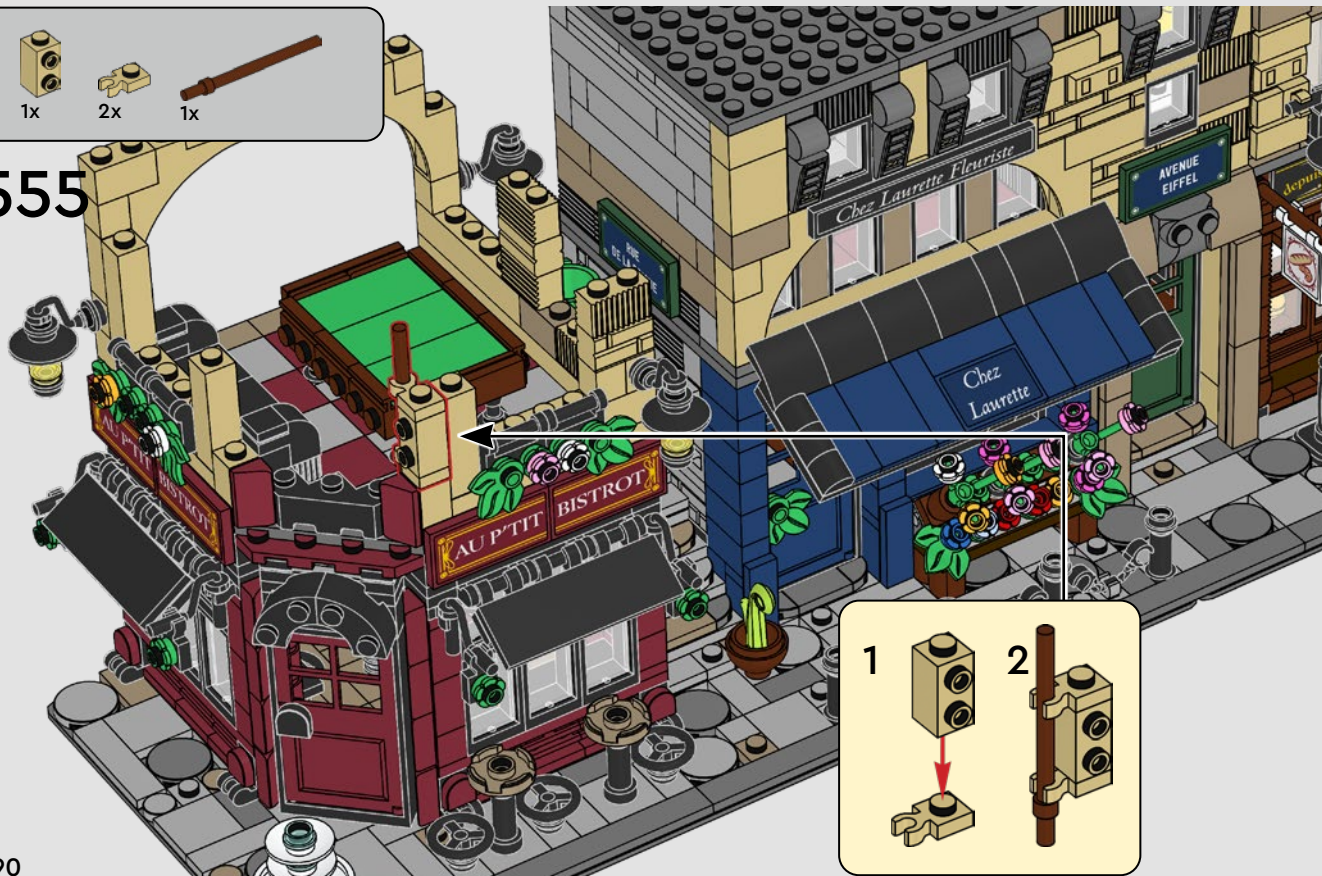

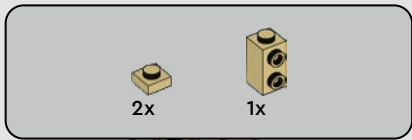

556

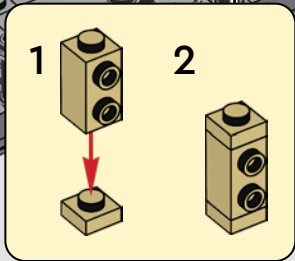
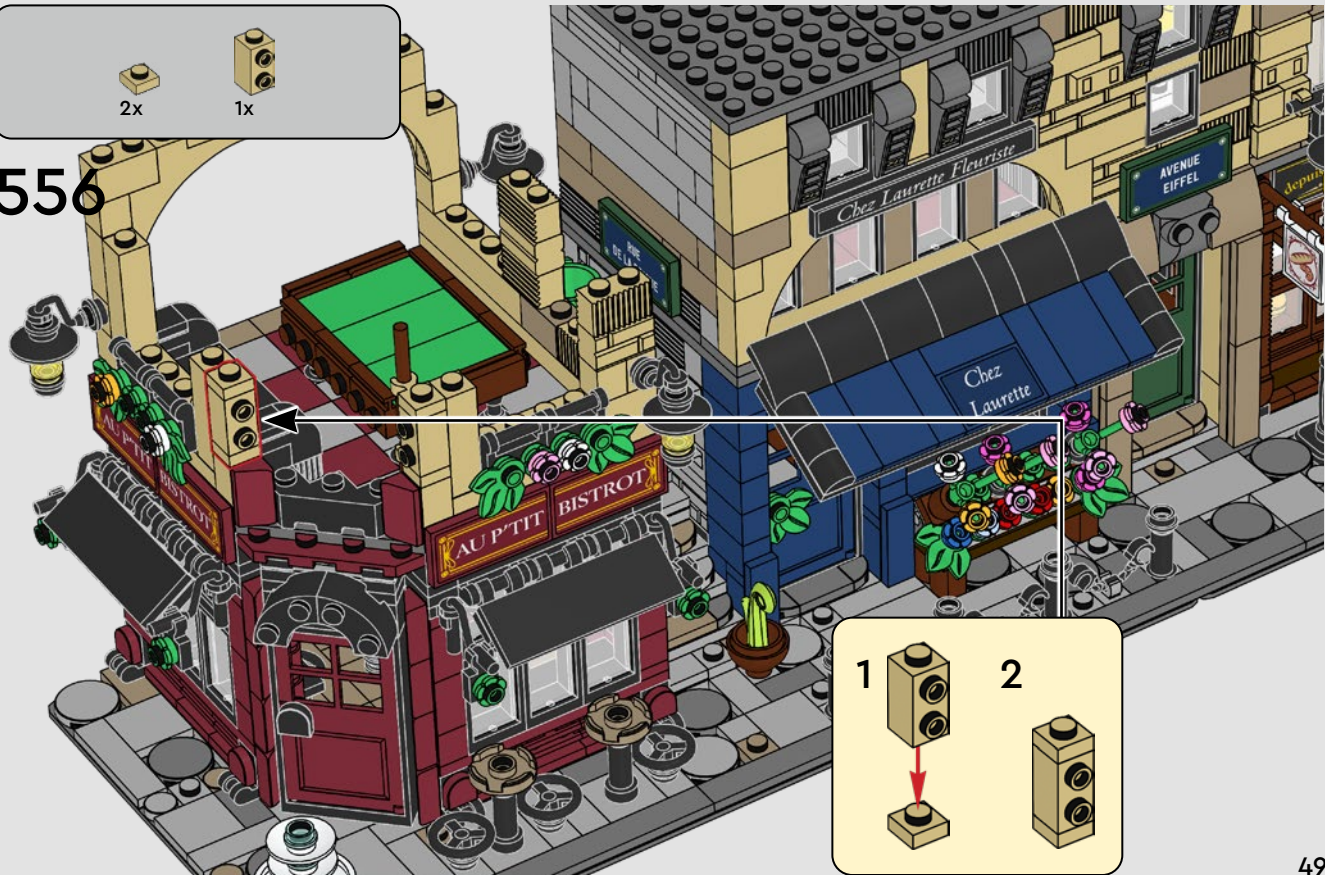





2x

557

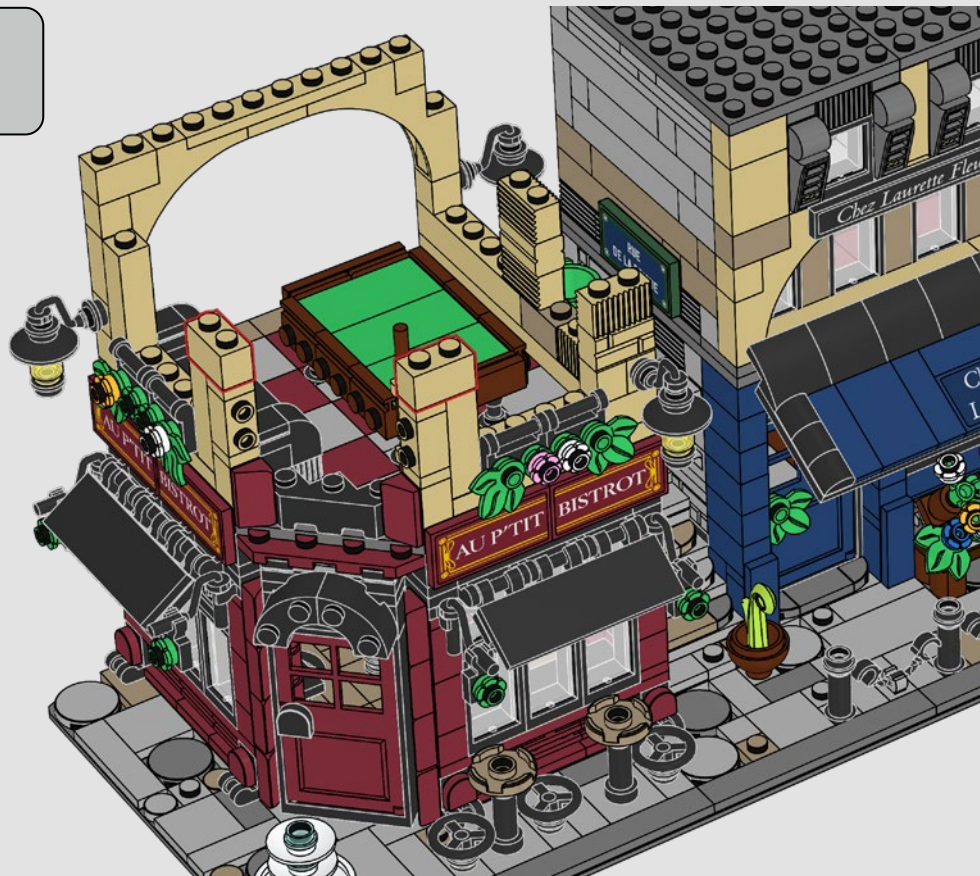







4x

559



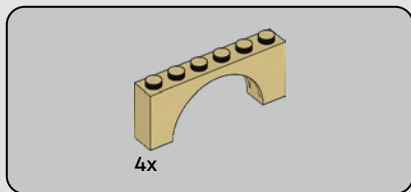

560

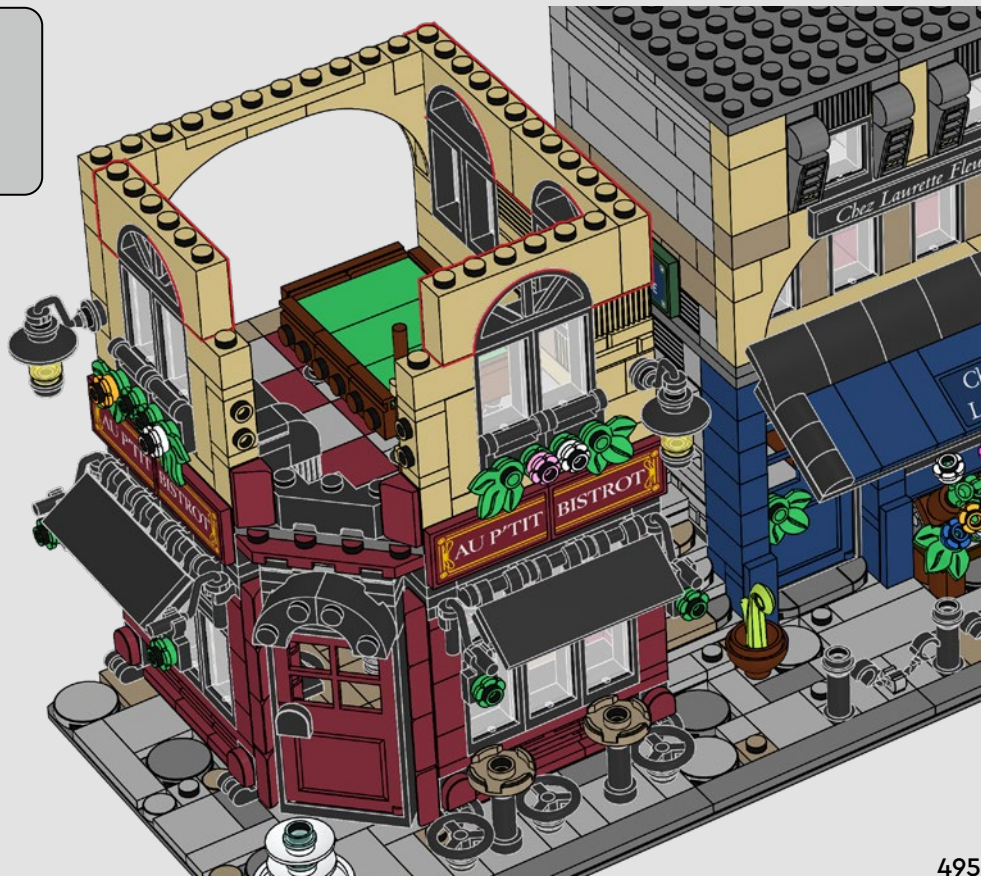



2x



2x

# 561





562

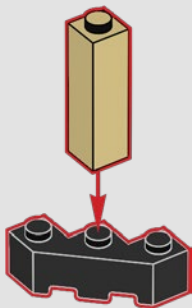

563

1

2



2x

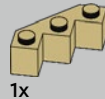
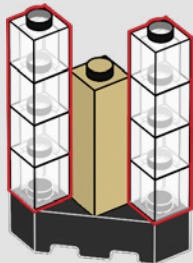

564

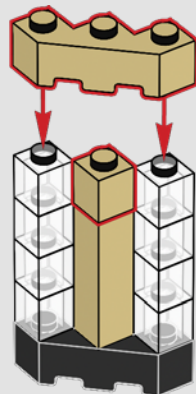



565

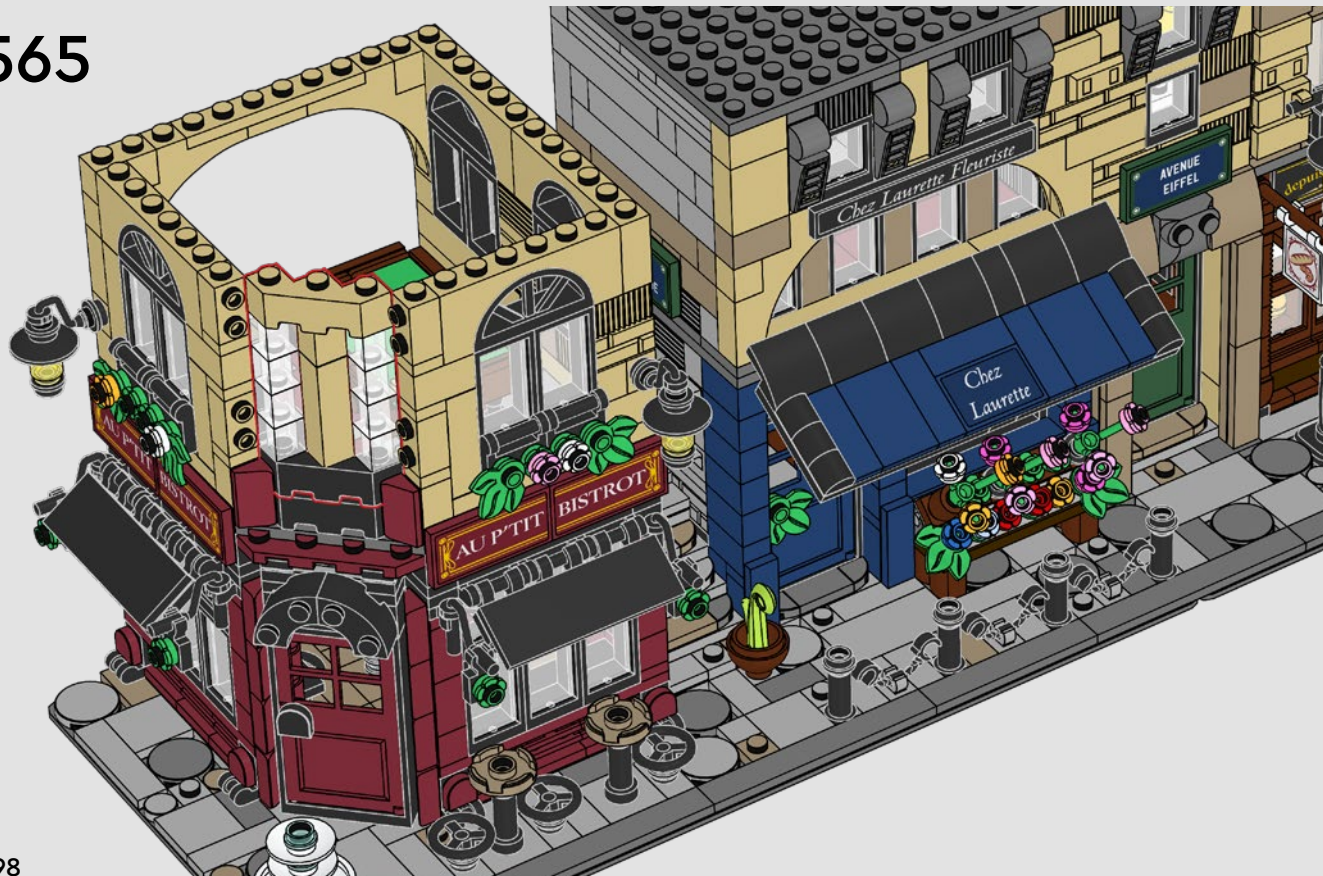

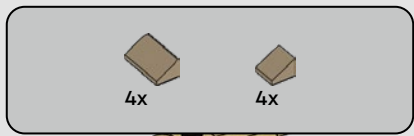

566



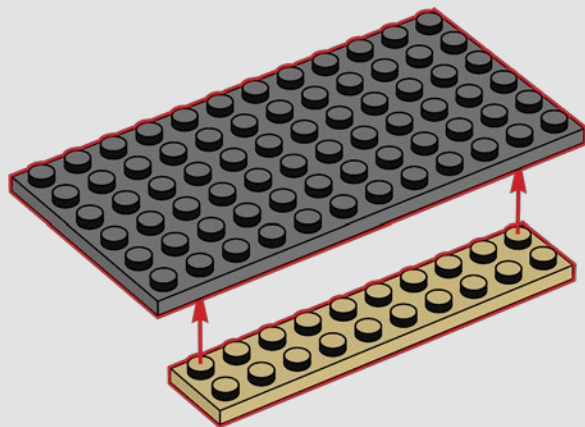
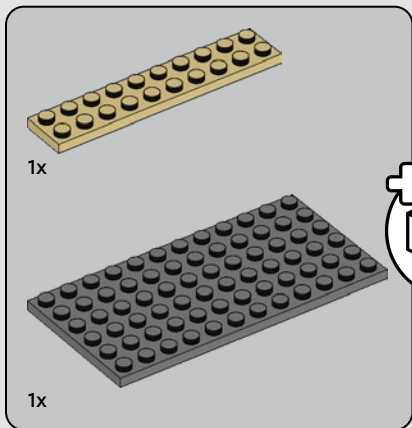
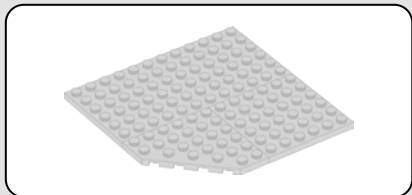

567

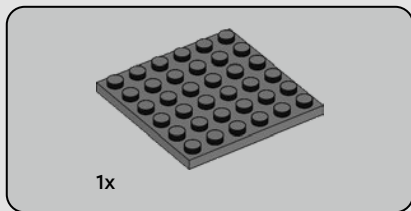

568

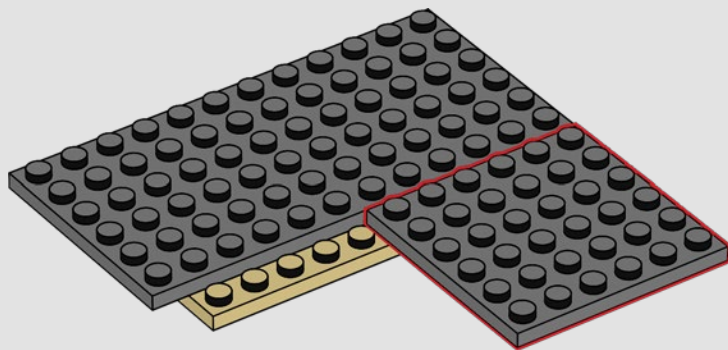



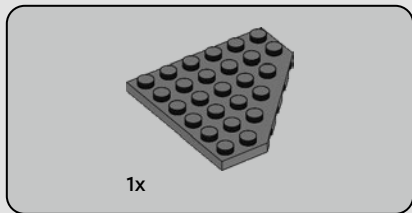

569

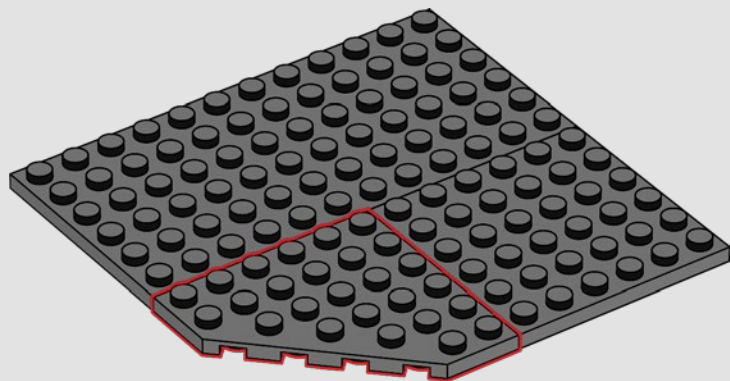

570



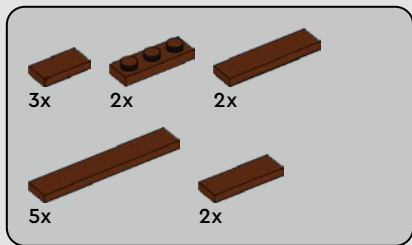

571



504



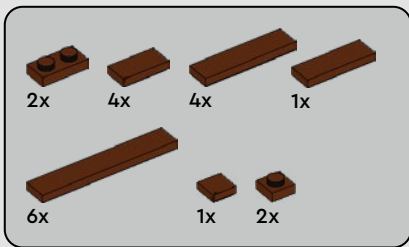

572







5x



6x

# 573



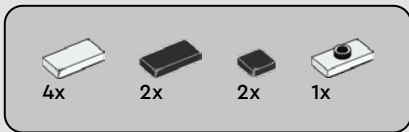

574







2x

# 577

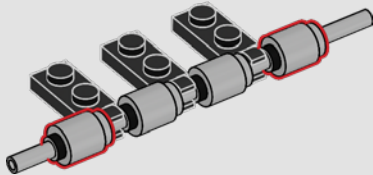

2x

# 578

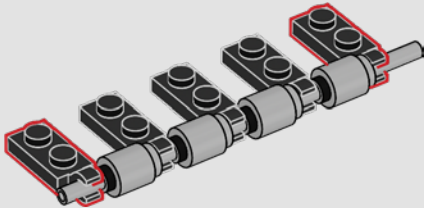

1x



2x

# 579

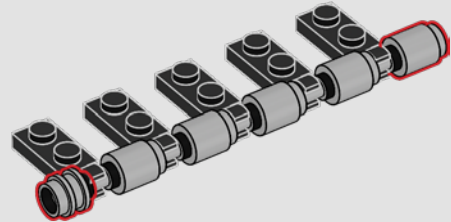



580





5x

581





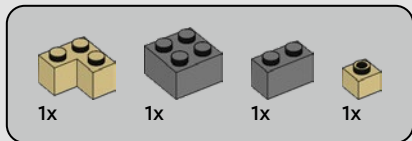

582



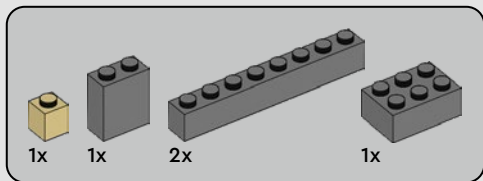

583

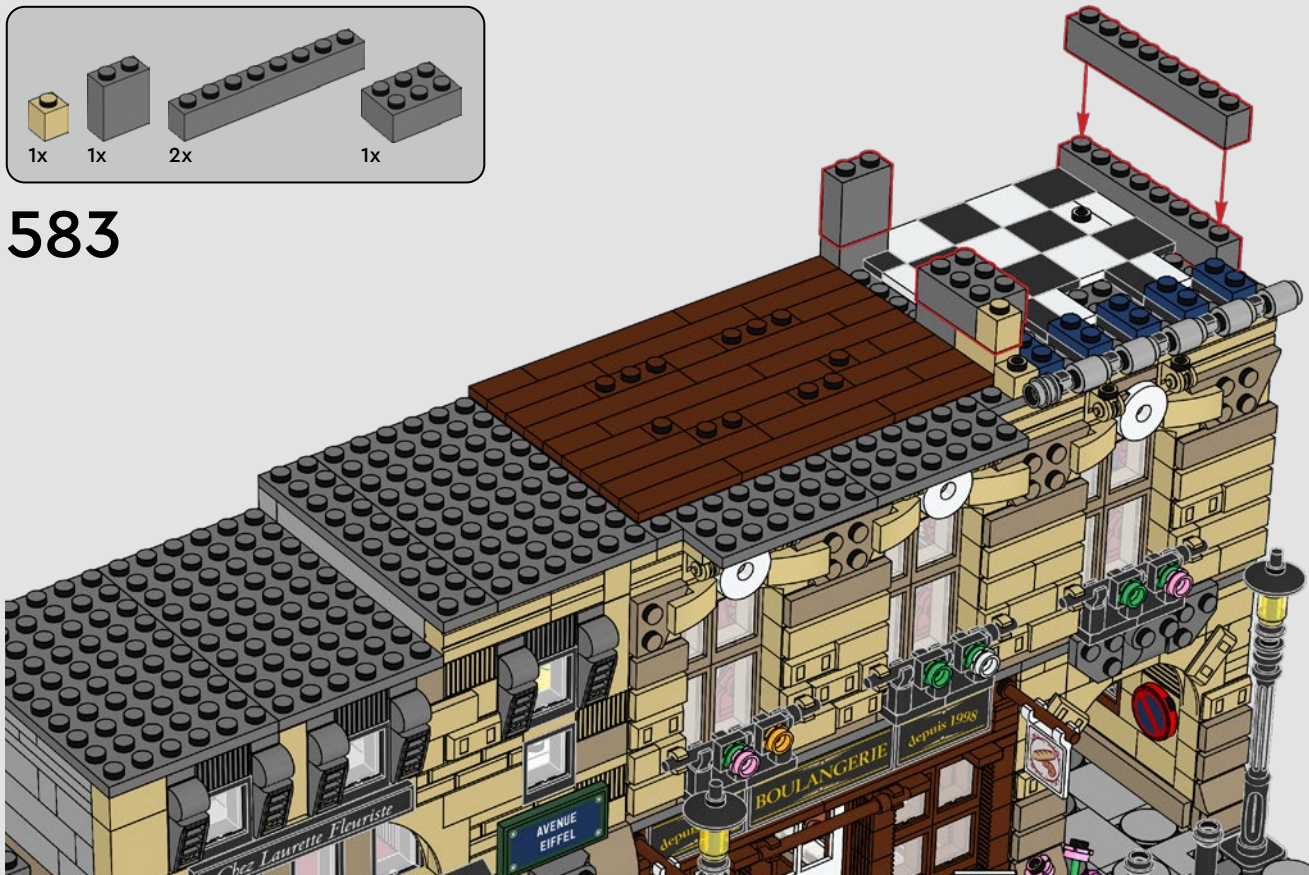



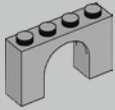

4x

584





1x



1x

# 585

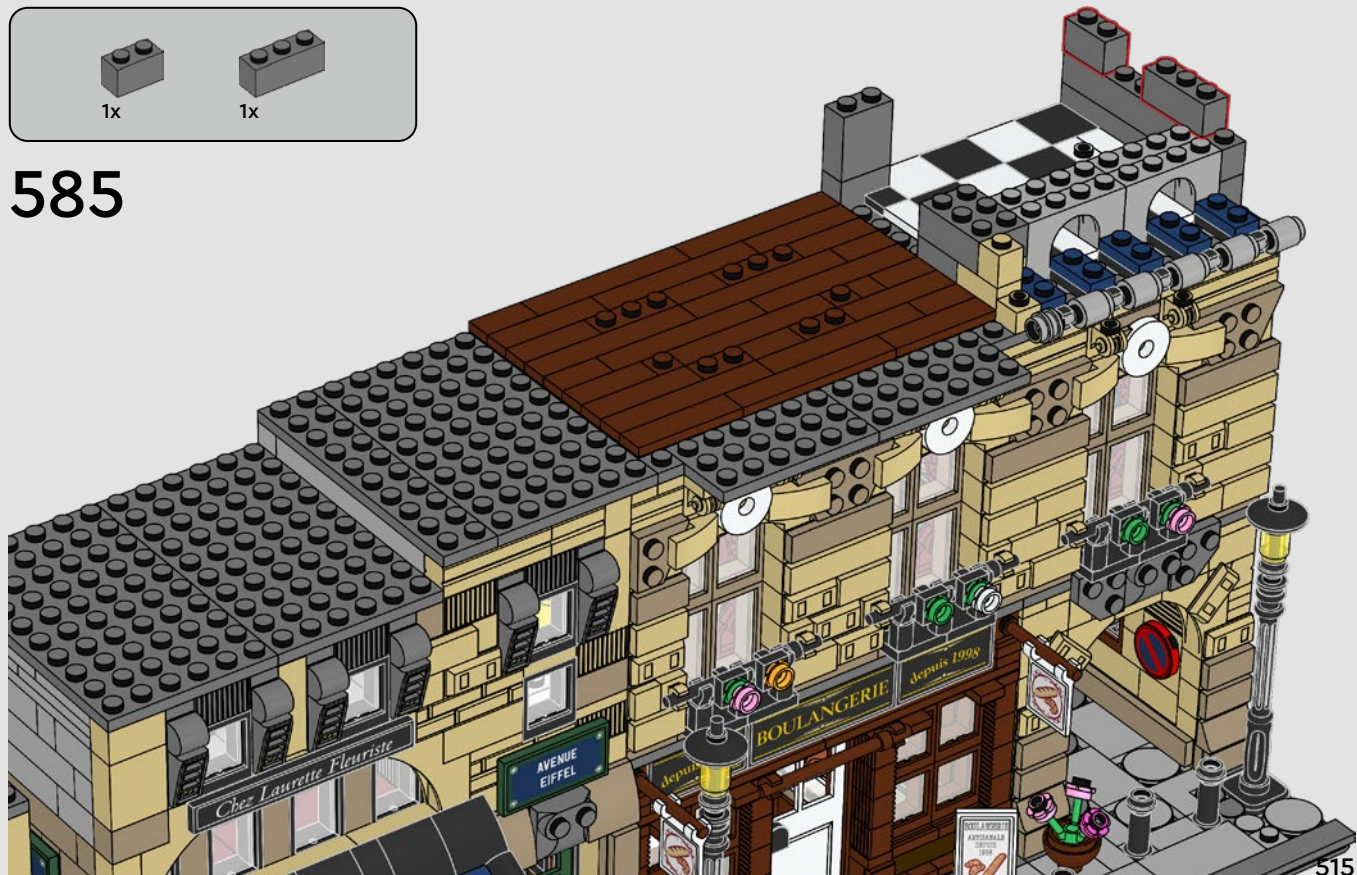



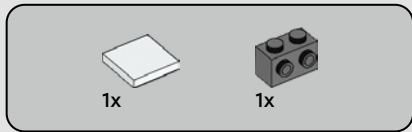

586

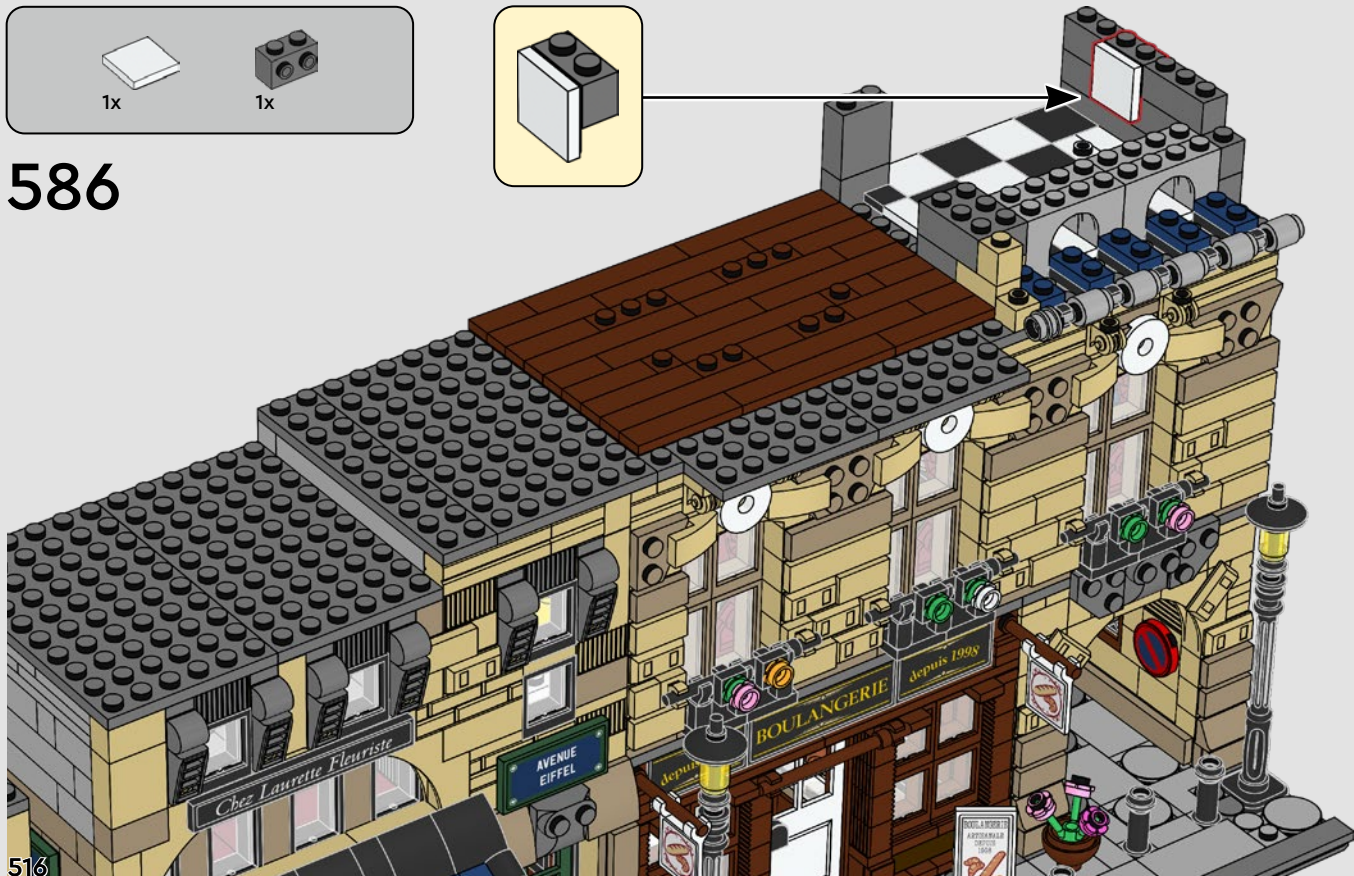
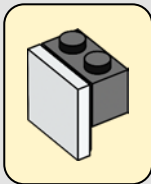

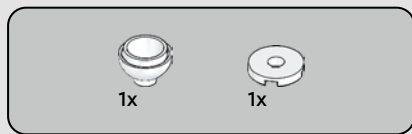

587

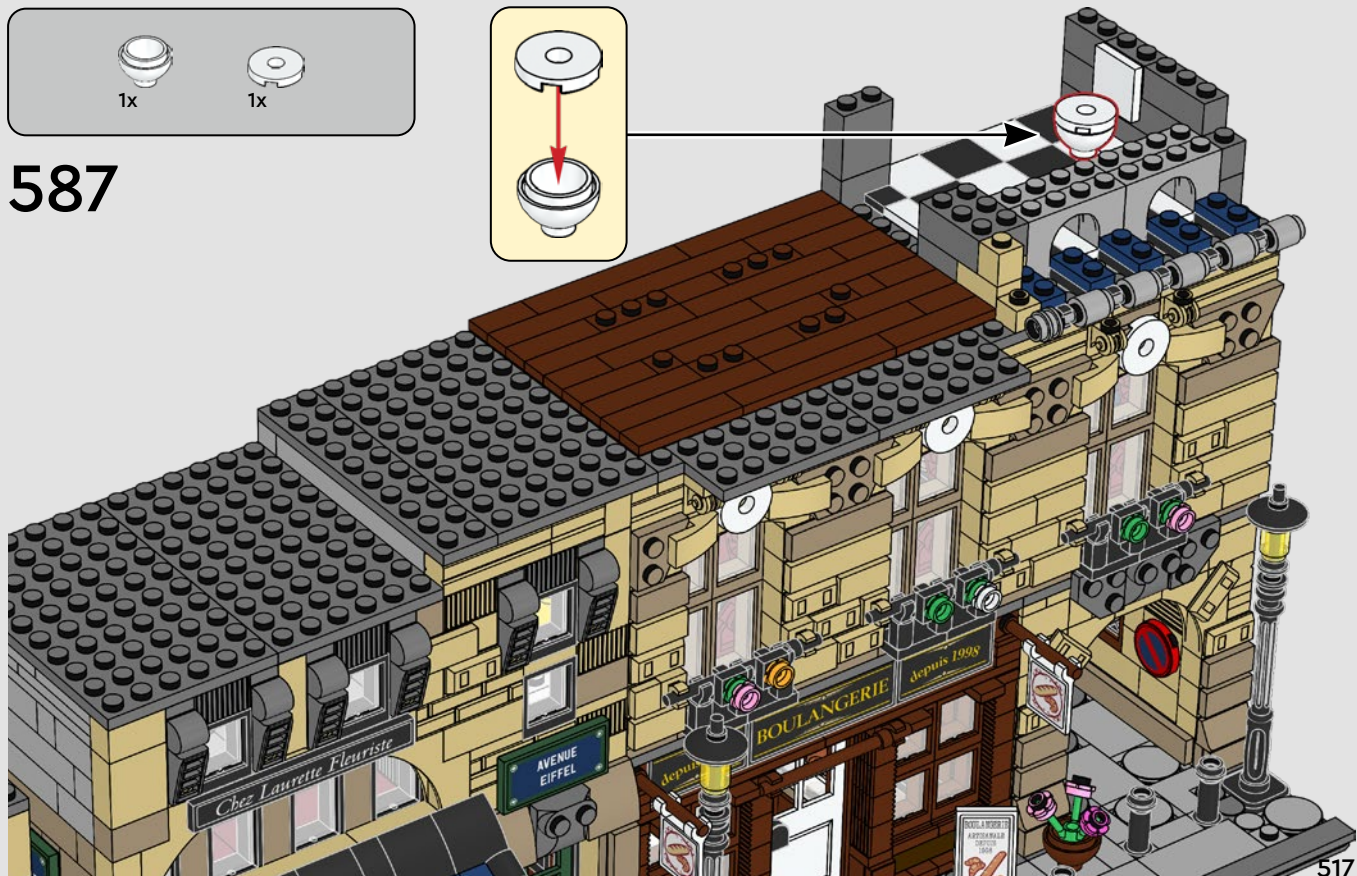
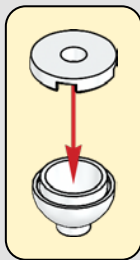



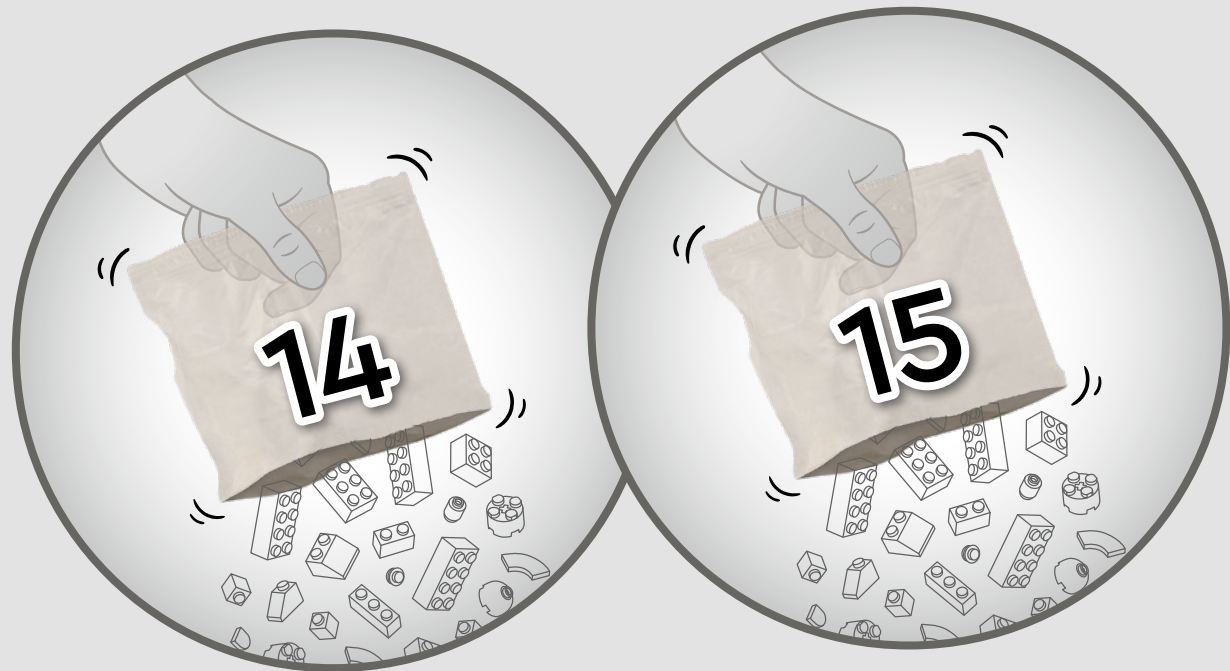



5x

# 588



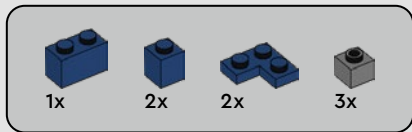

589







2x



4x

# 590

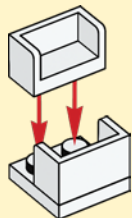

2x

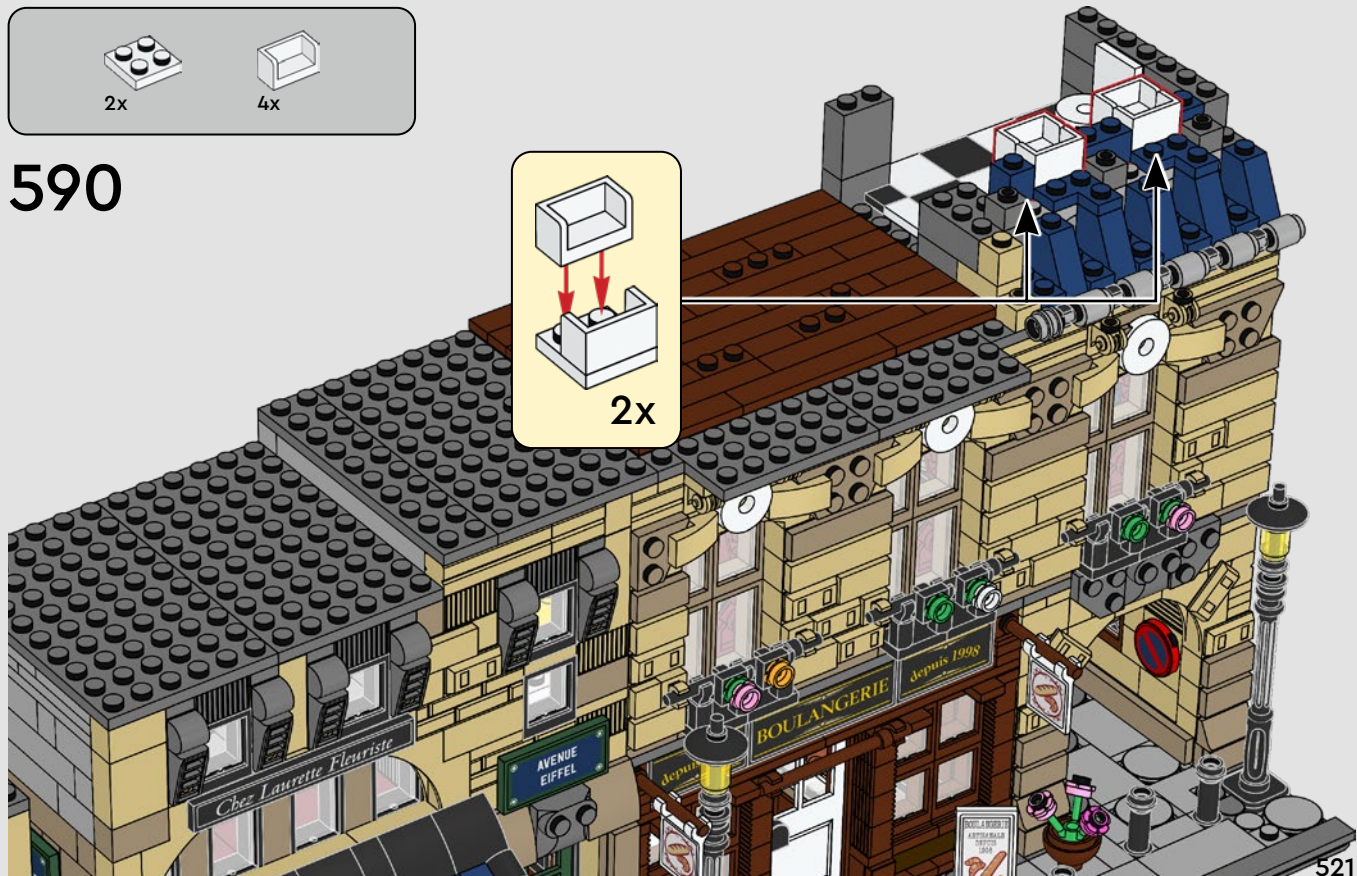





2x



5x

# 591



522

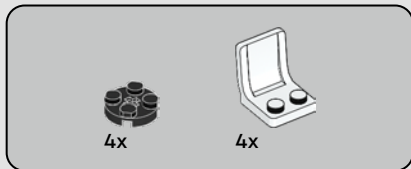

592





593

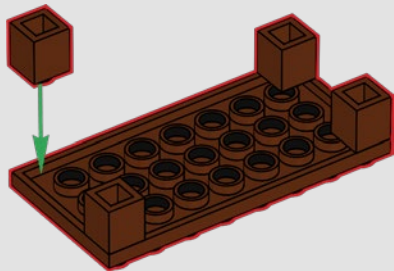

594

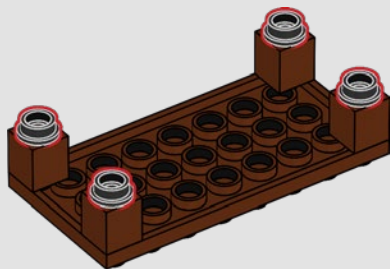



595

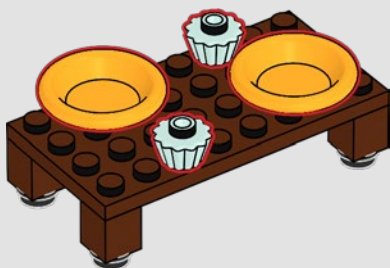

596

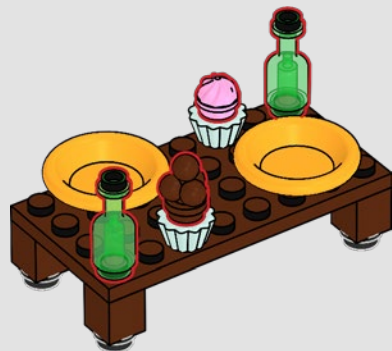



597



526



1x



1x

# 598





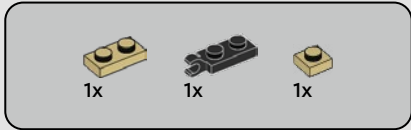

599

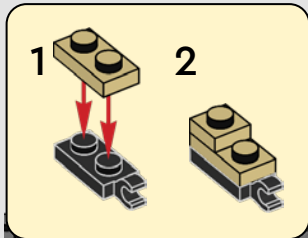

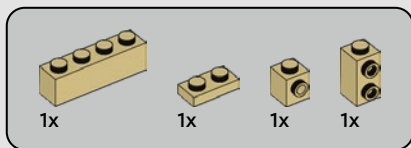

600





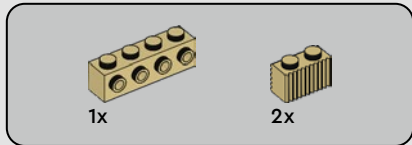

601





1x



1x



1x

# 602





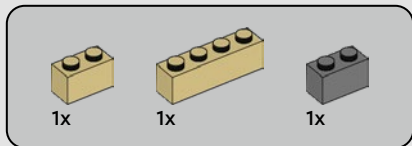

603



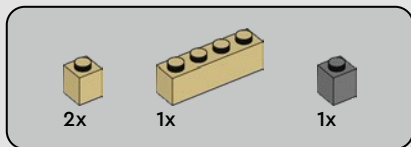

604







2x



1x

# 605





1x



2x

# 606







2x

607





6x

608



3x







6x

609



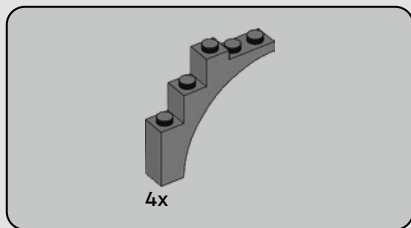

610



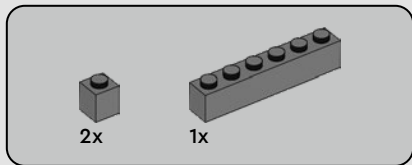

611





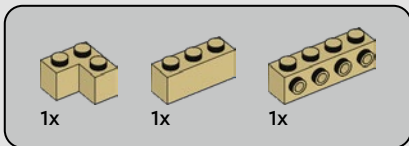

612





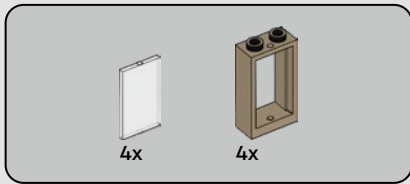

613

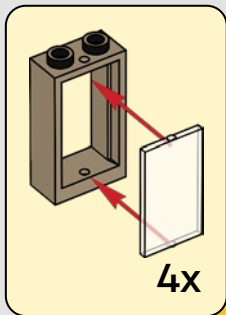





615

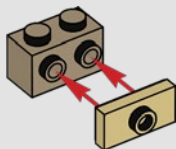

616

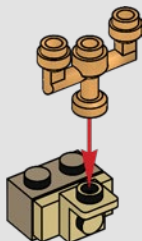

617

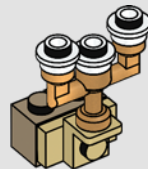

618

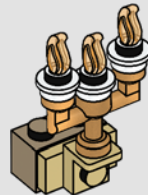



619





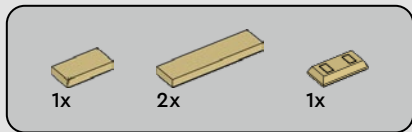

620



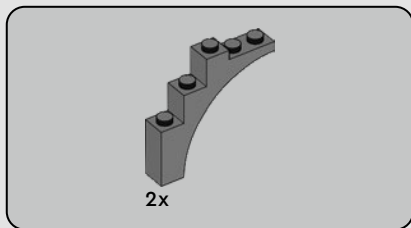

621



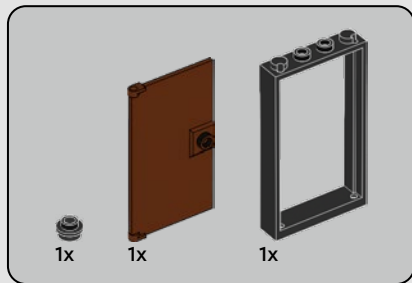

622

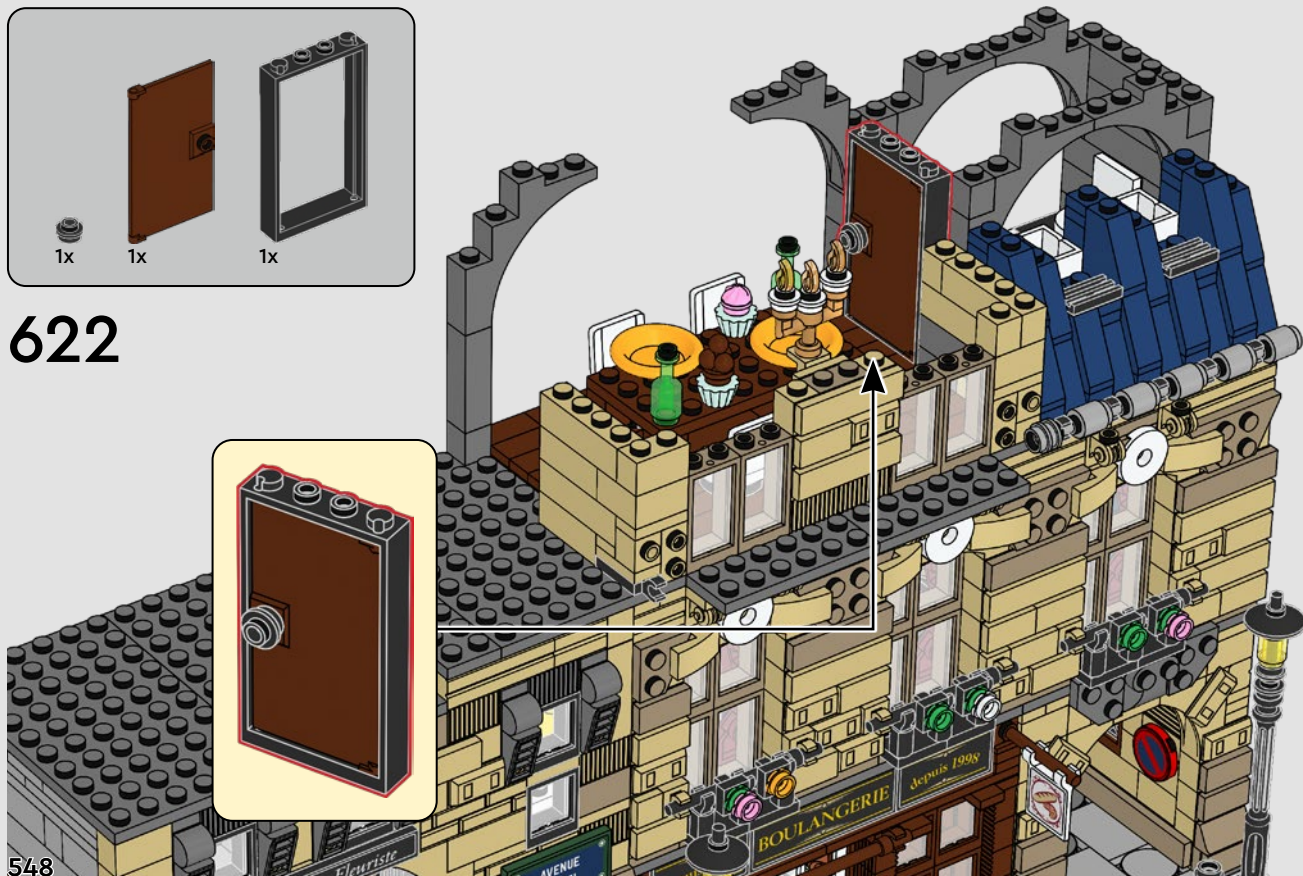
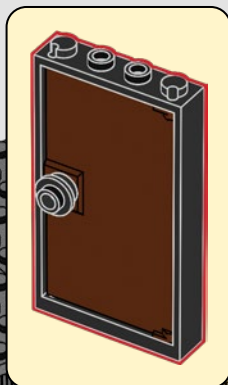



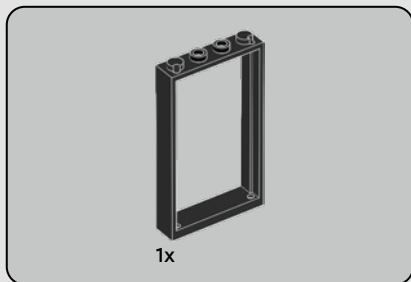

623





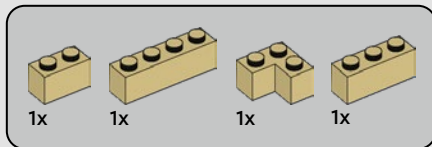

624



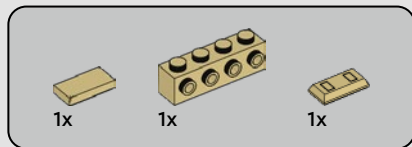

625

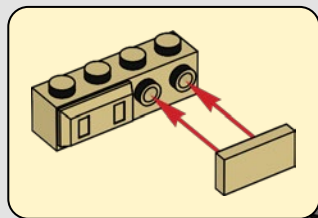

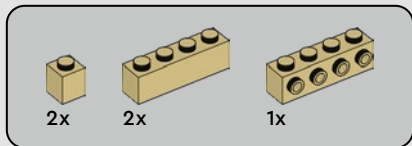

626





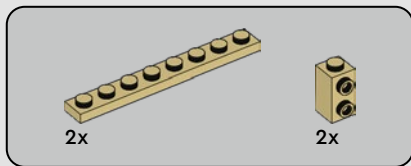

627





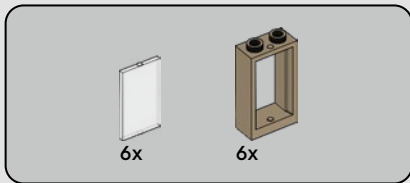

628

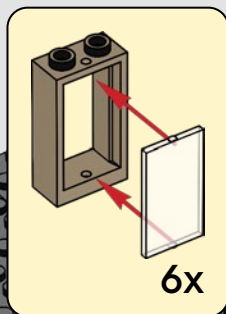

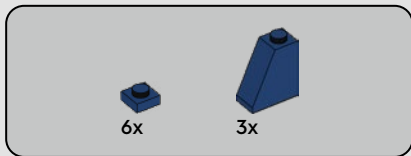

629

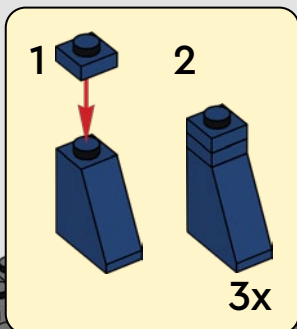

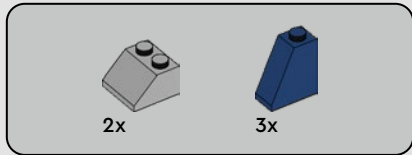

630







4x

631





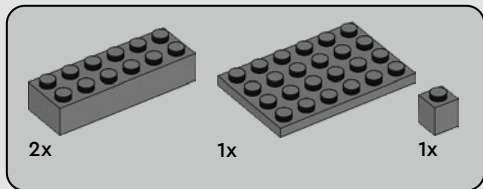

632





5x

633





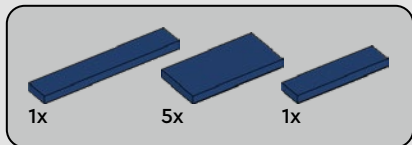

634



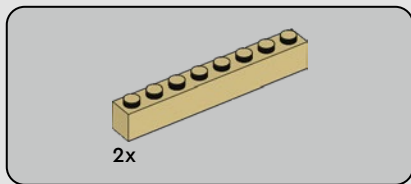

635





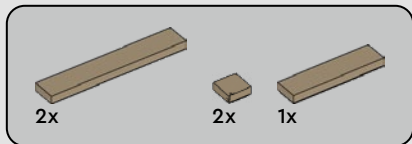

636



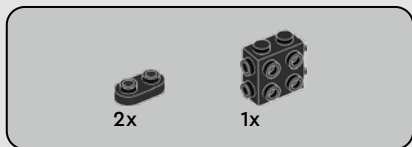
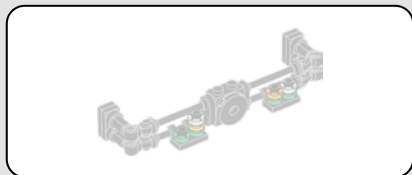

637

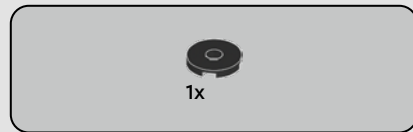
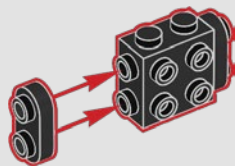

638



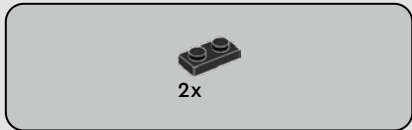
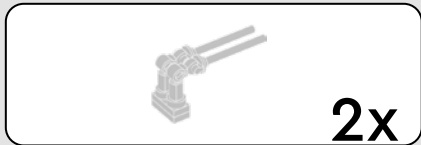

639

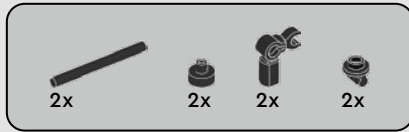

640

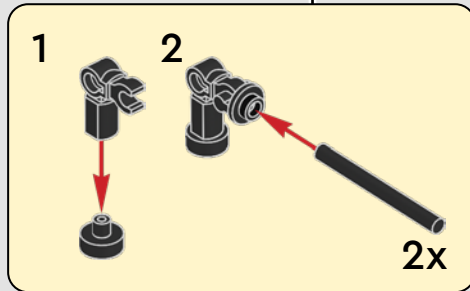
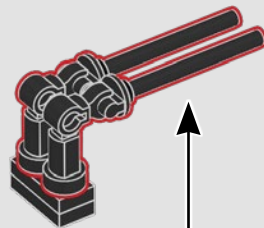

2x

# 641

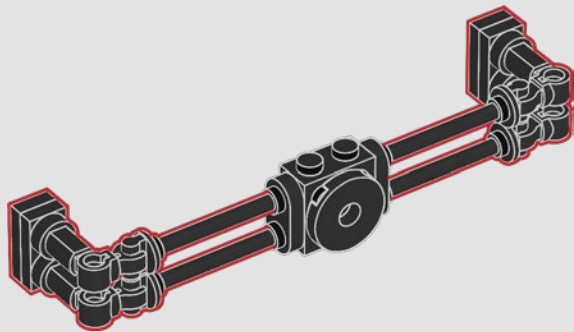

# 642

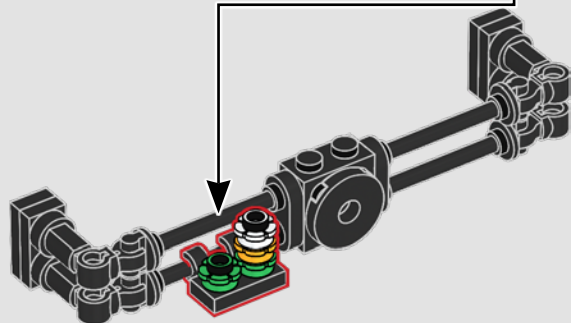
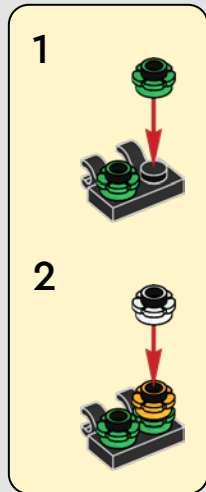





643

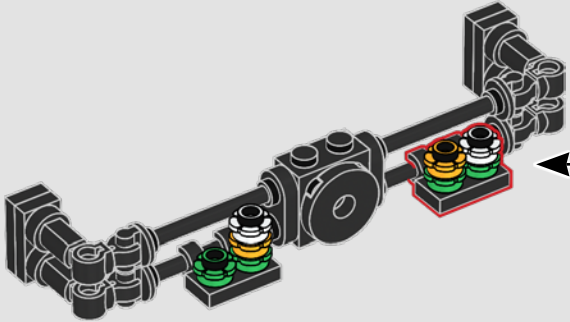
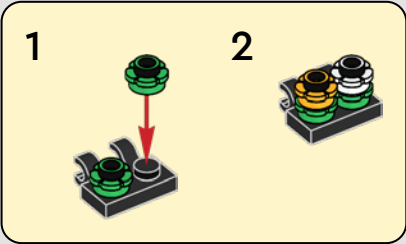

644



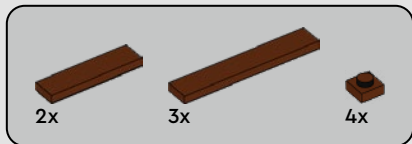

645

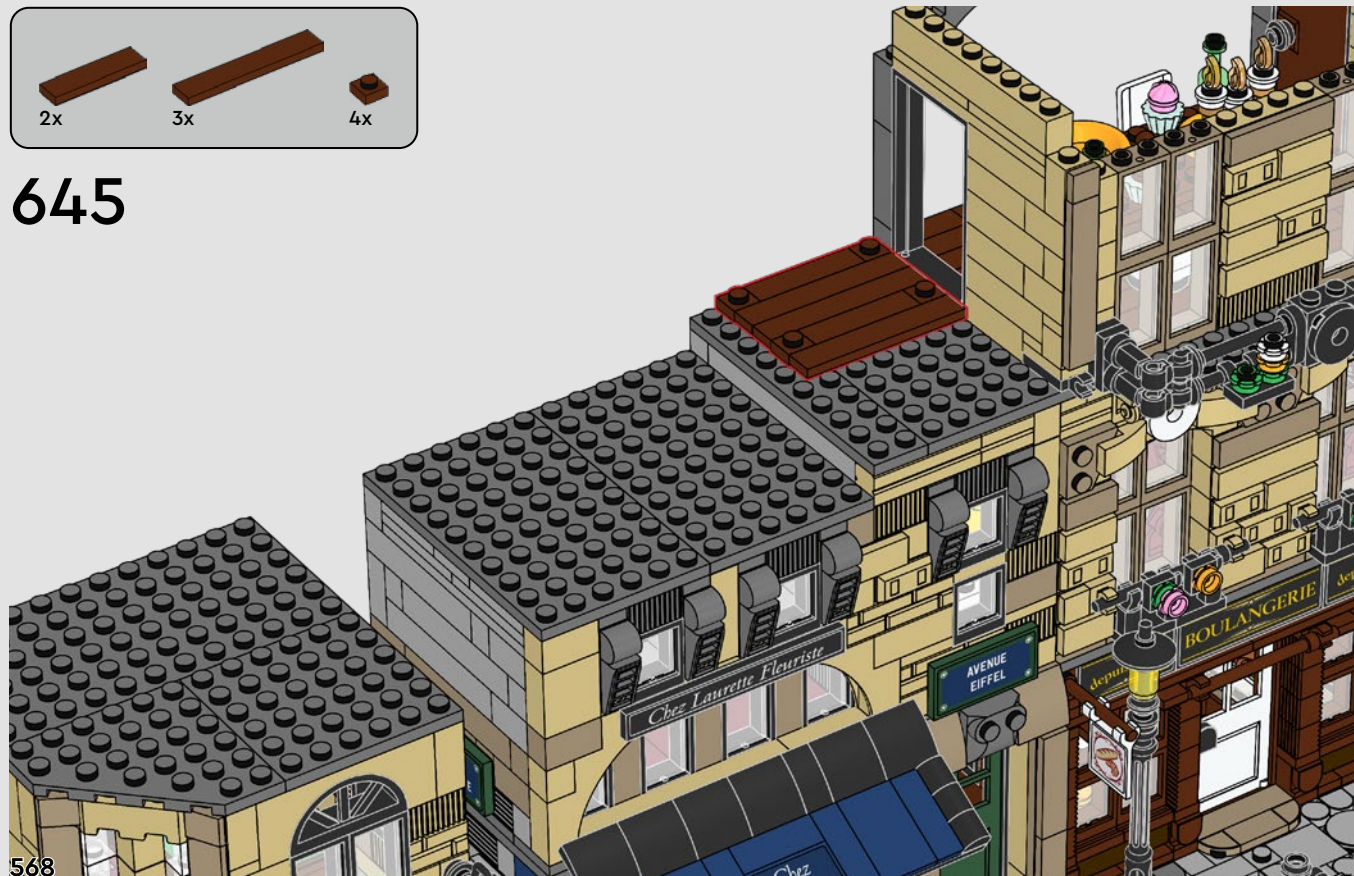





2x



2x

# 646





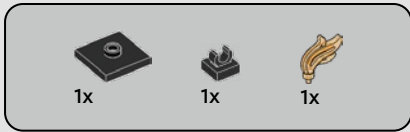

647

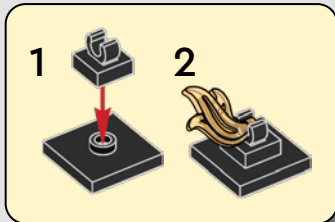

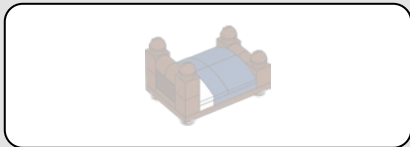

648

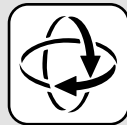
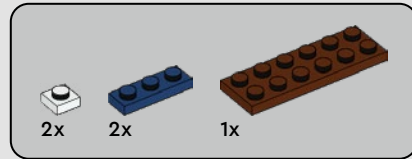
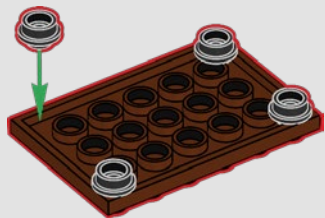

649





650

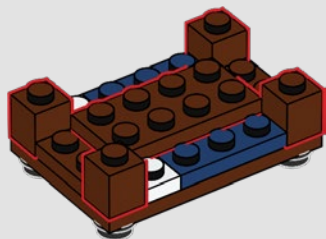

651

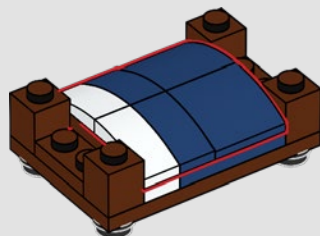



2x



1x

652

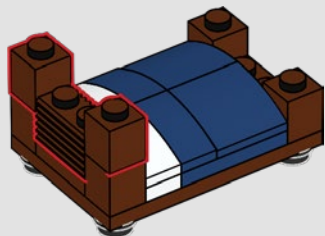

4x

653

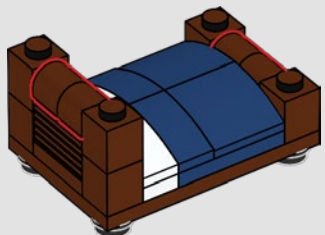

4x

654

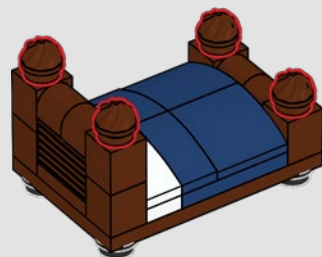



655

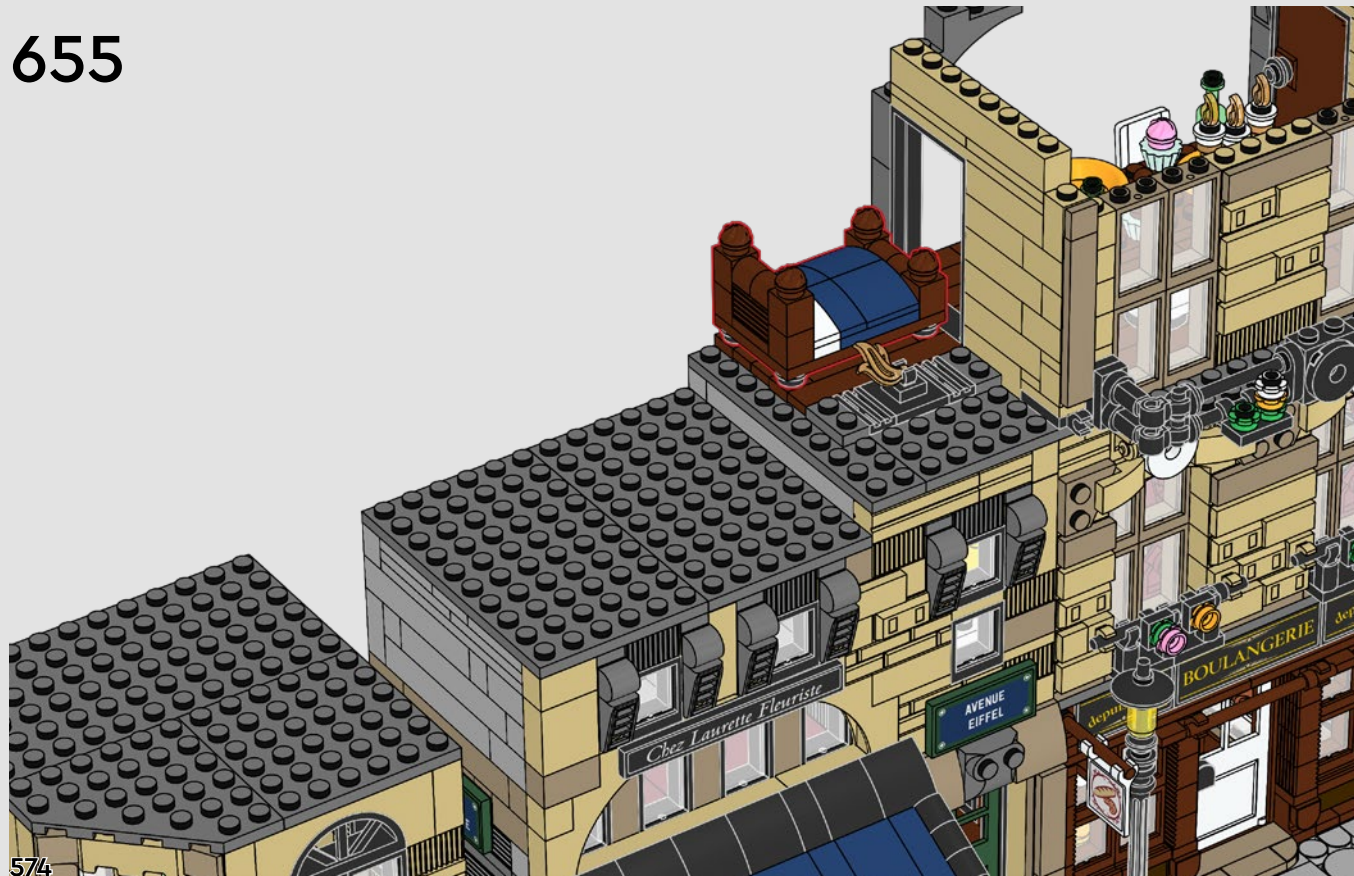

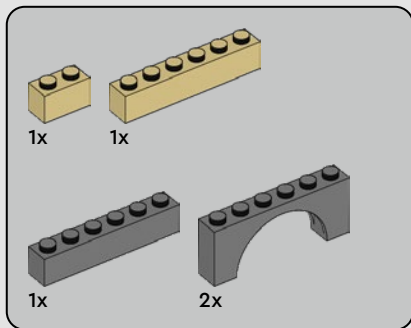

656

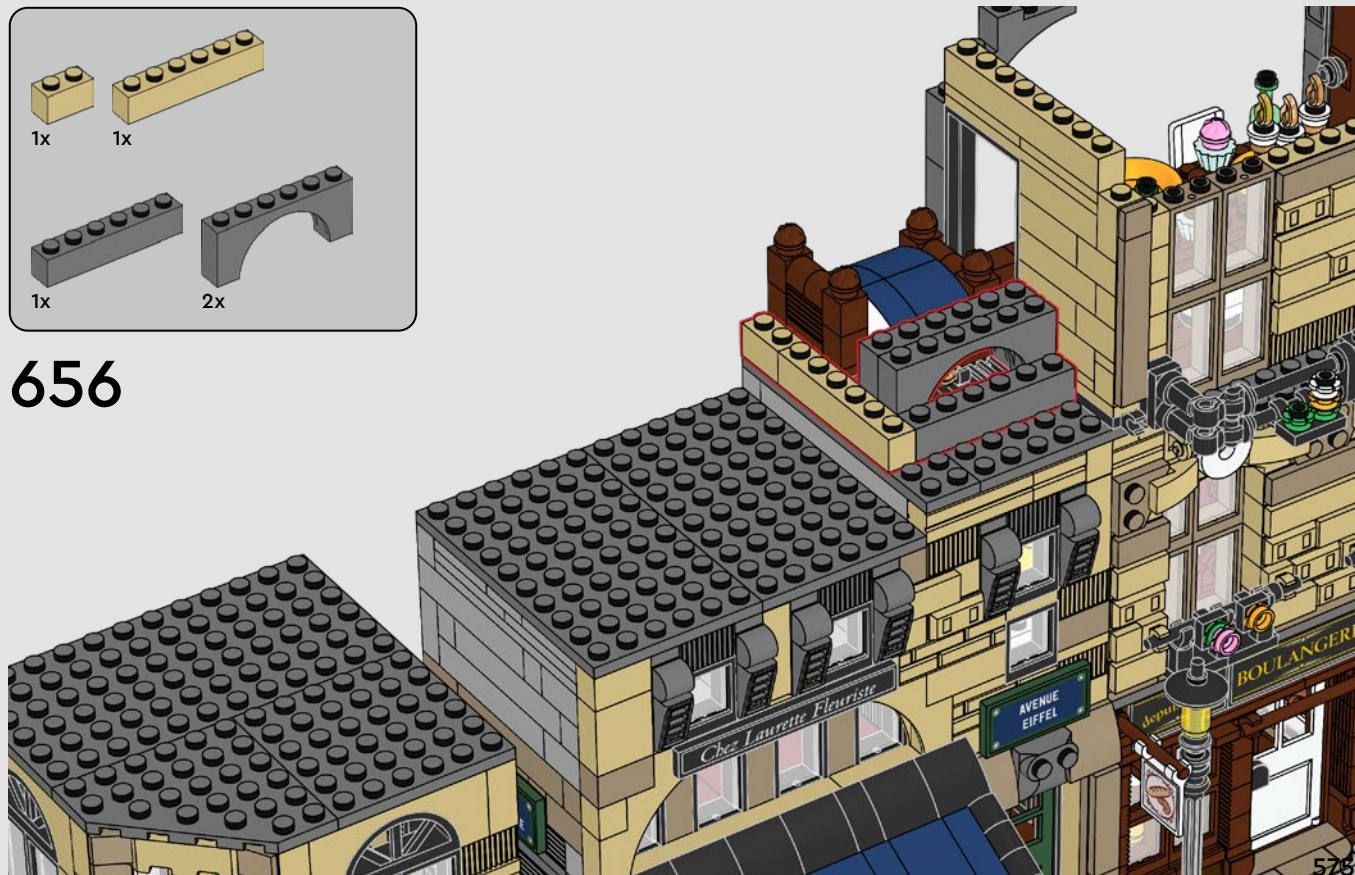

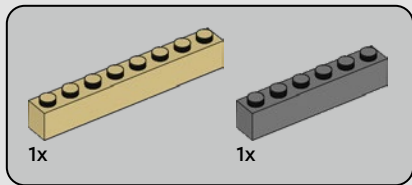

657

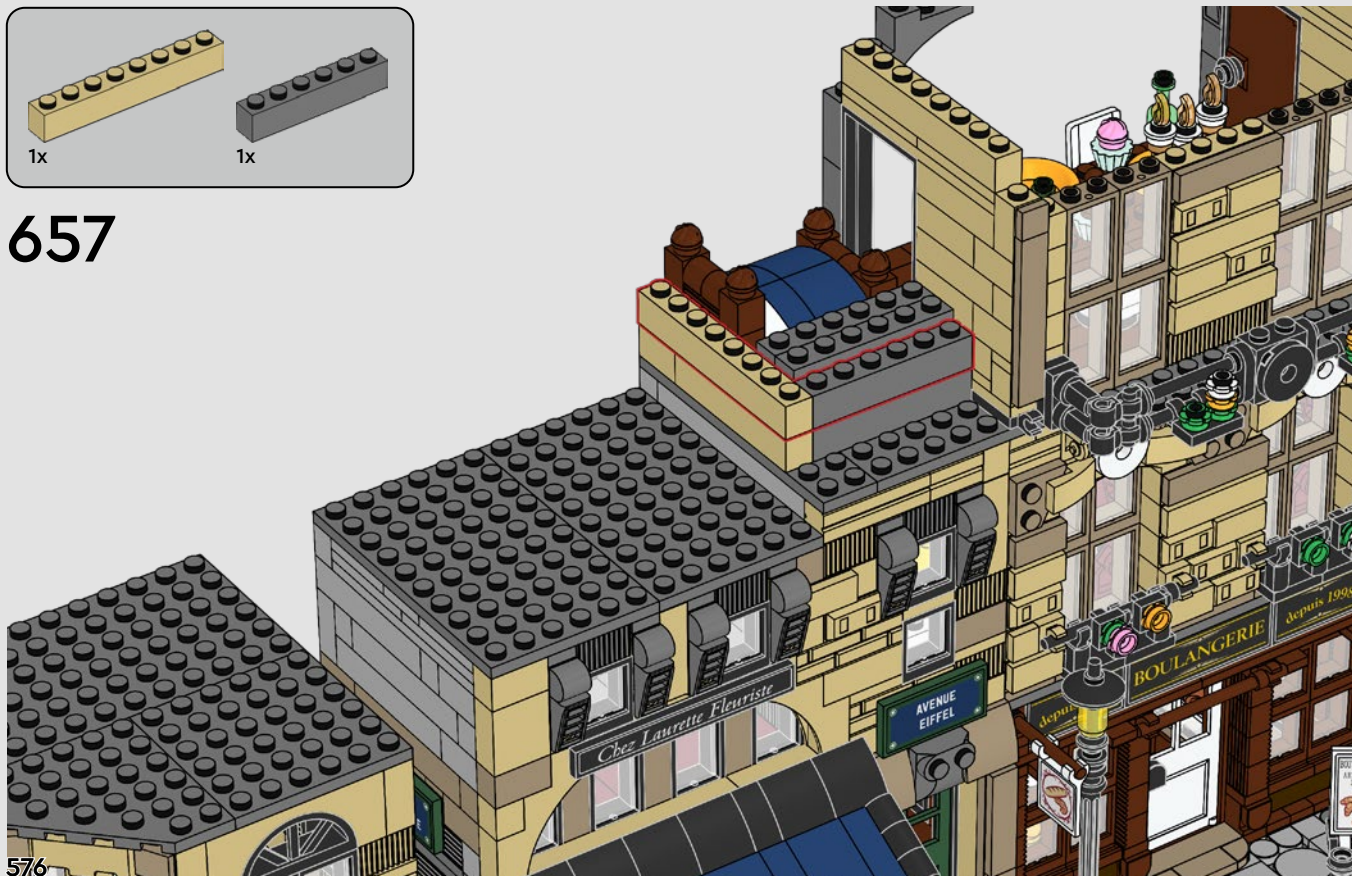



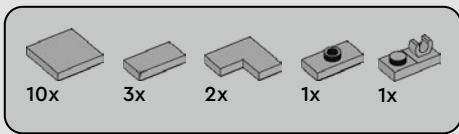

658

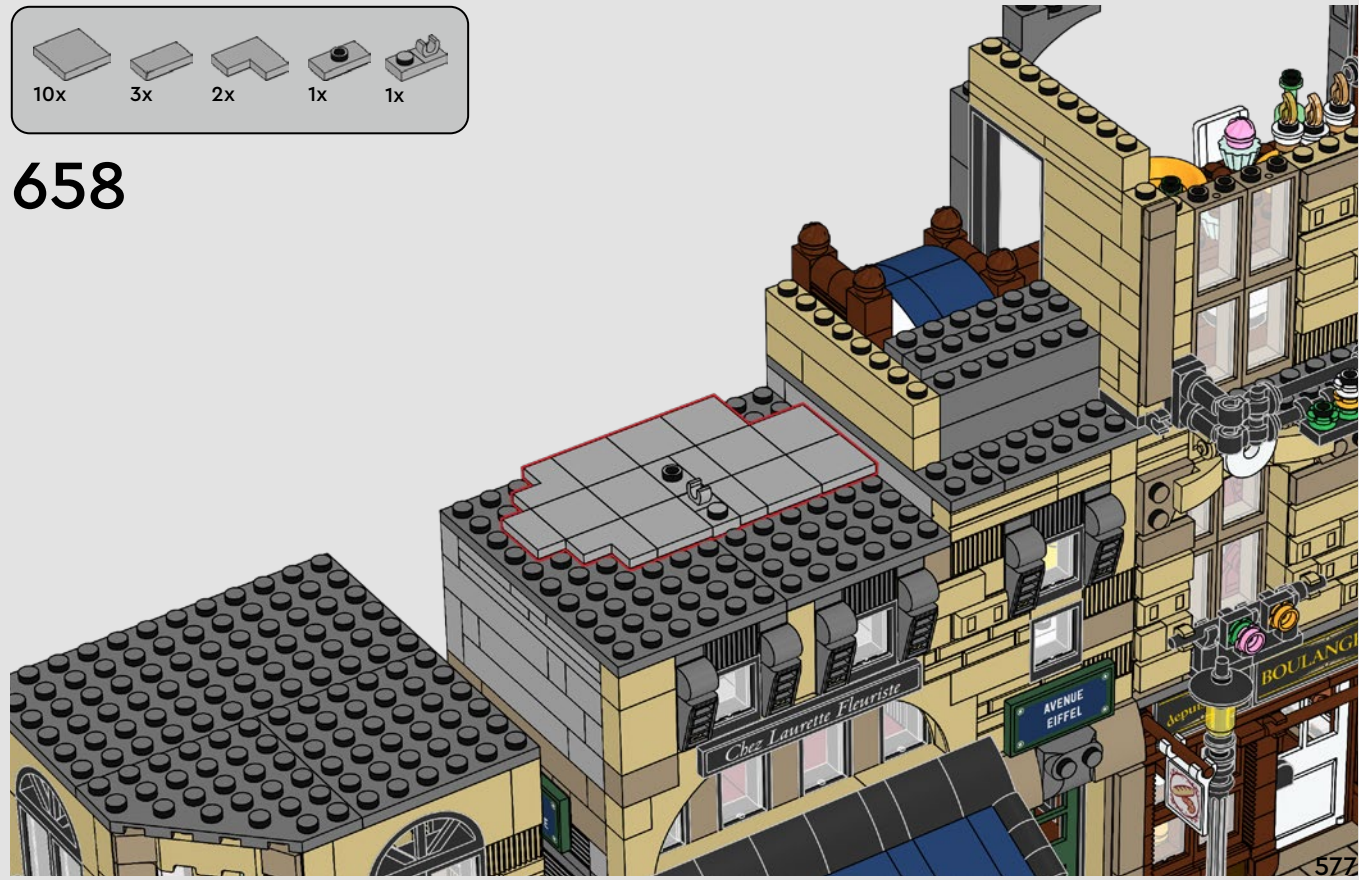



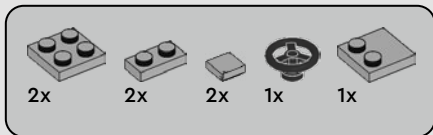

659



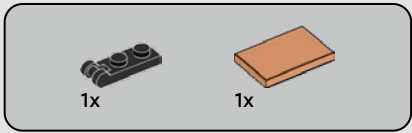

660

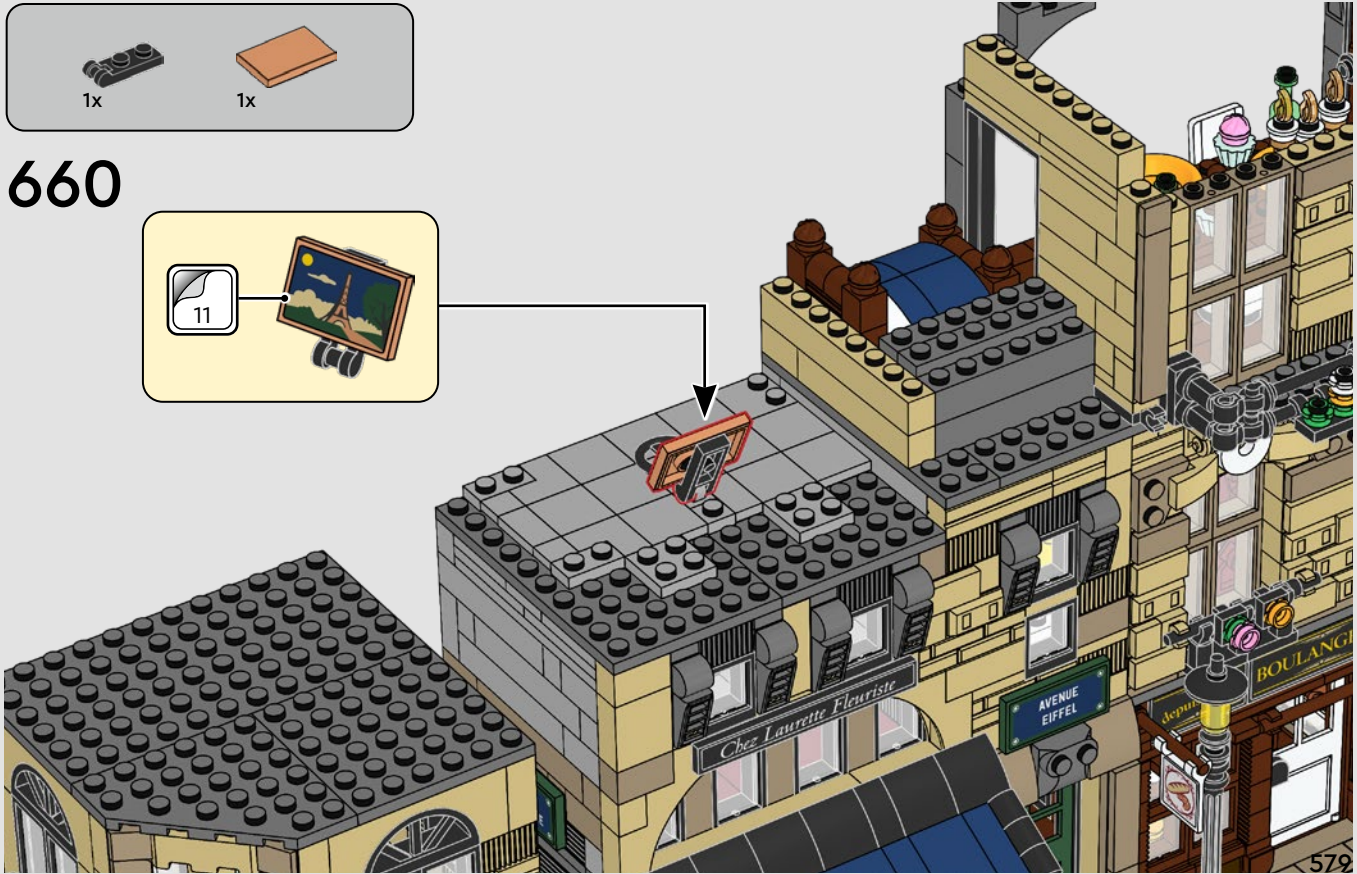
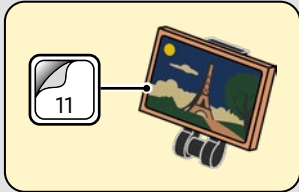

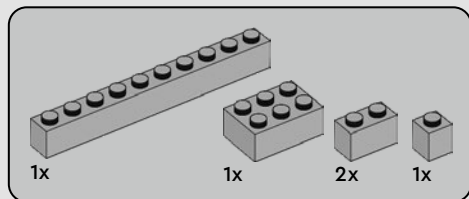

661







662

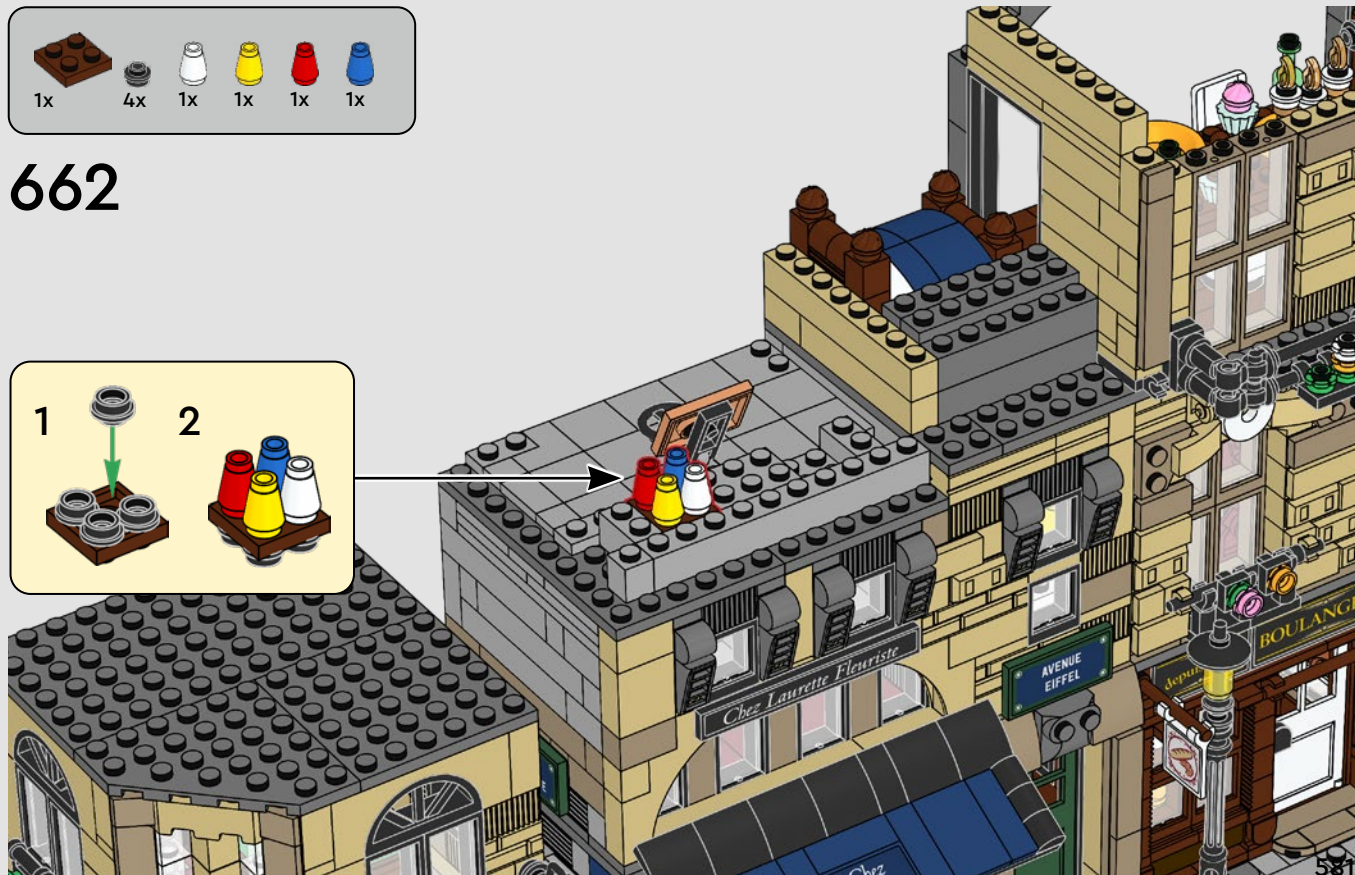





663



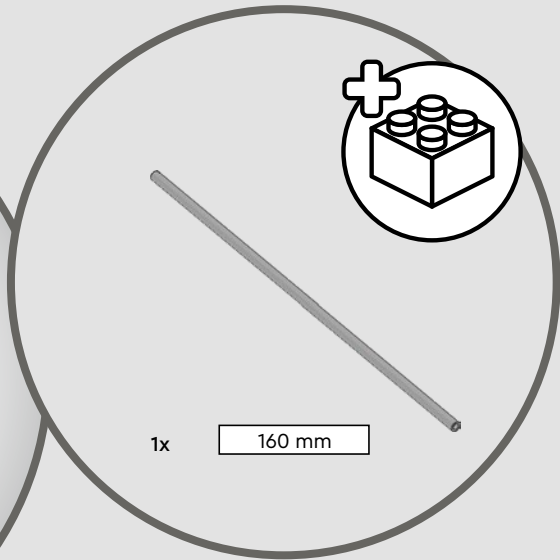

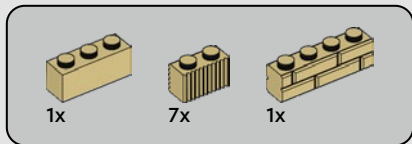

664



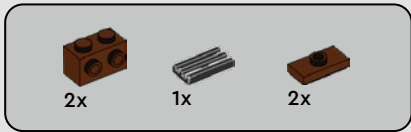

665

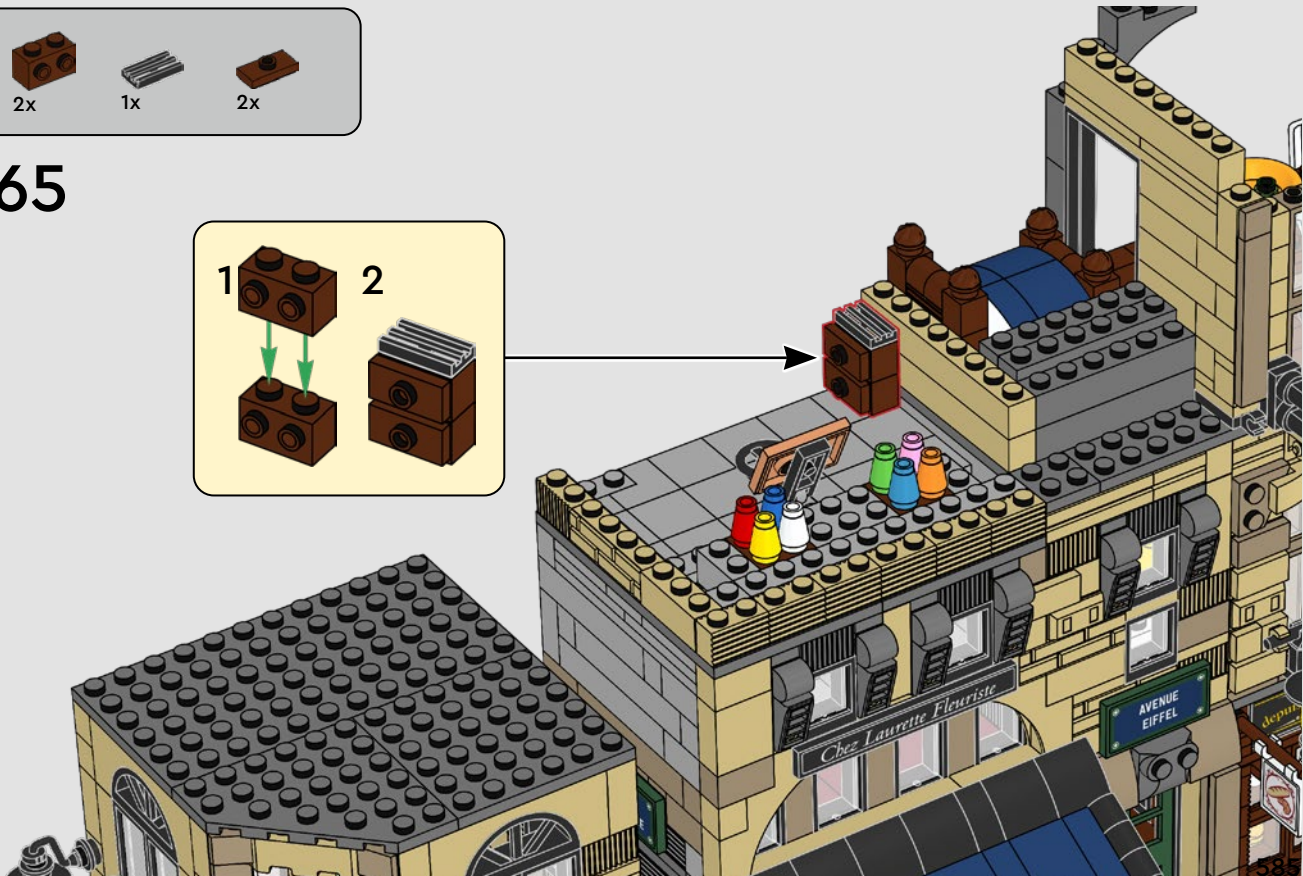
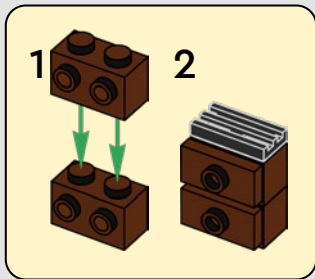



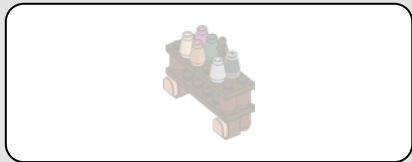

666

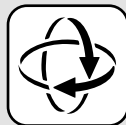
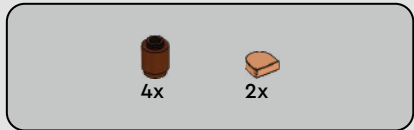
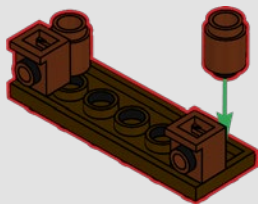

667

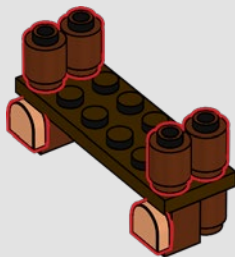

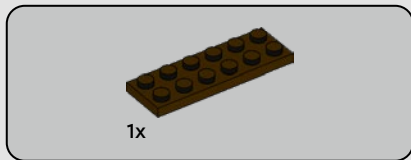

668

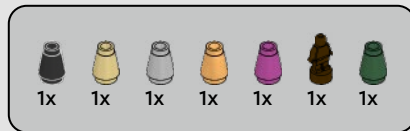
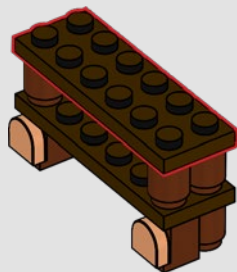

669



670



588

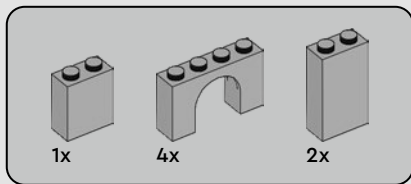

671





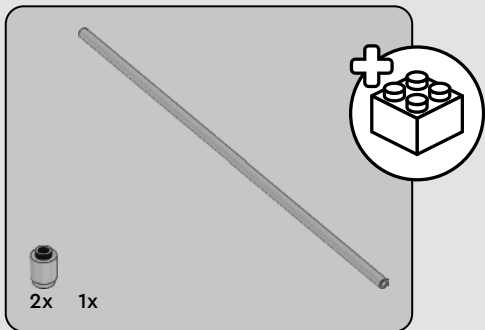
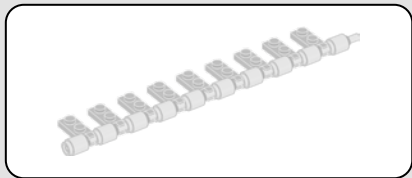

672

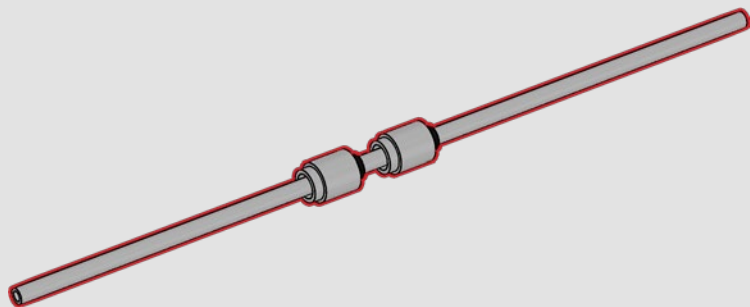

160 mm



3x

673

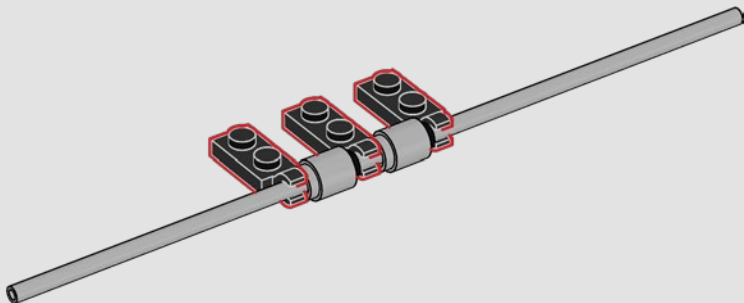



4x

674

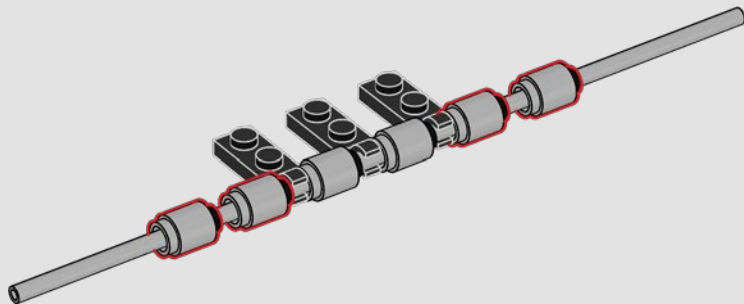



4x

675

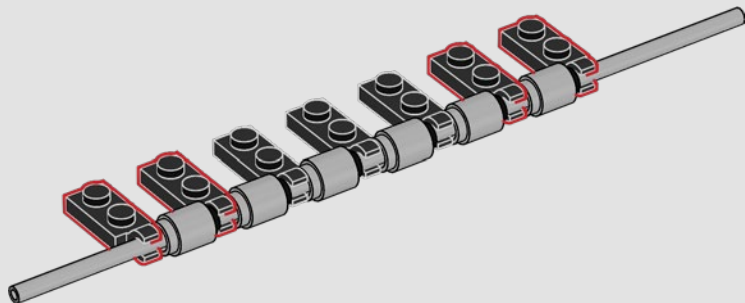





4x

676

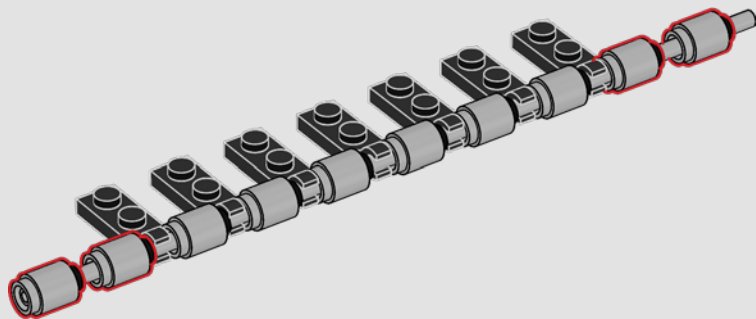



2x

677

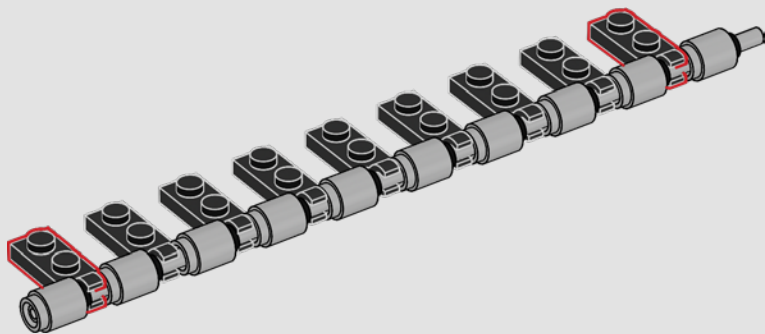

678



596

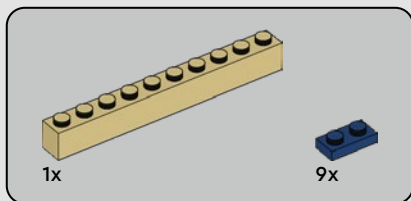

679





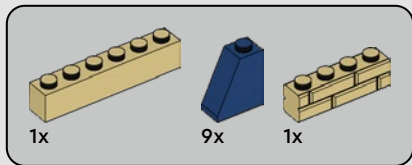

680





2x



1x

681



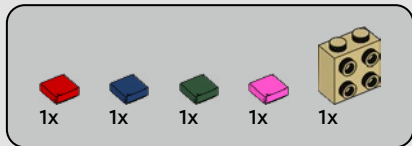

682







2x



1x



2x

# 683







3x



6x

# 684





1x



3x

685





9x

686





1x

2x

687







2x



1x

688



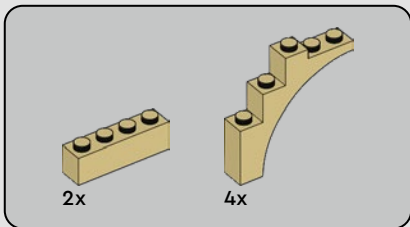

689

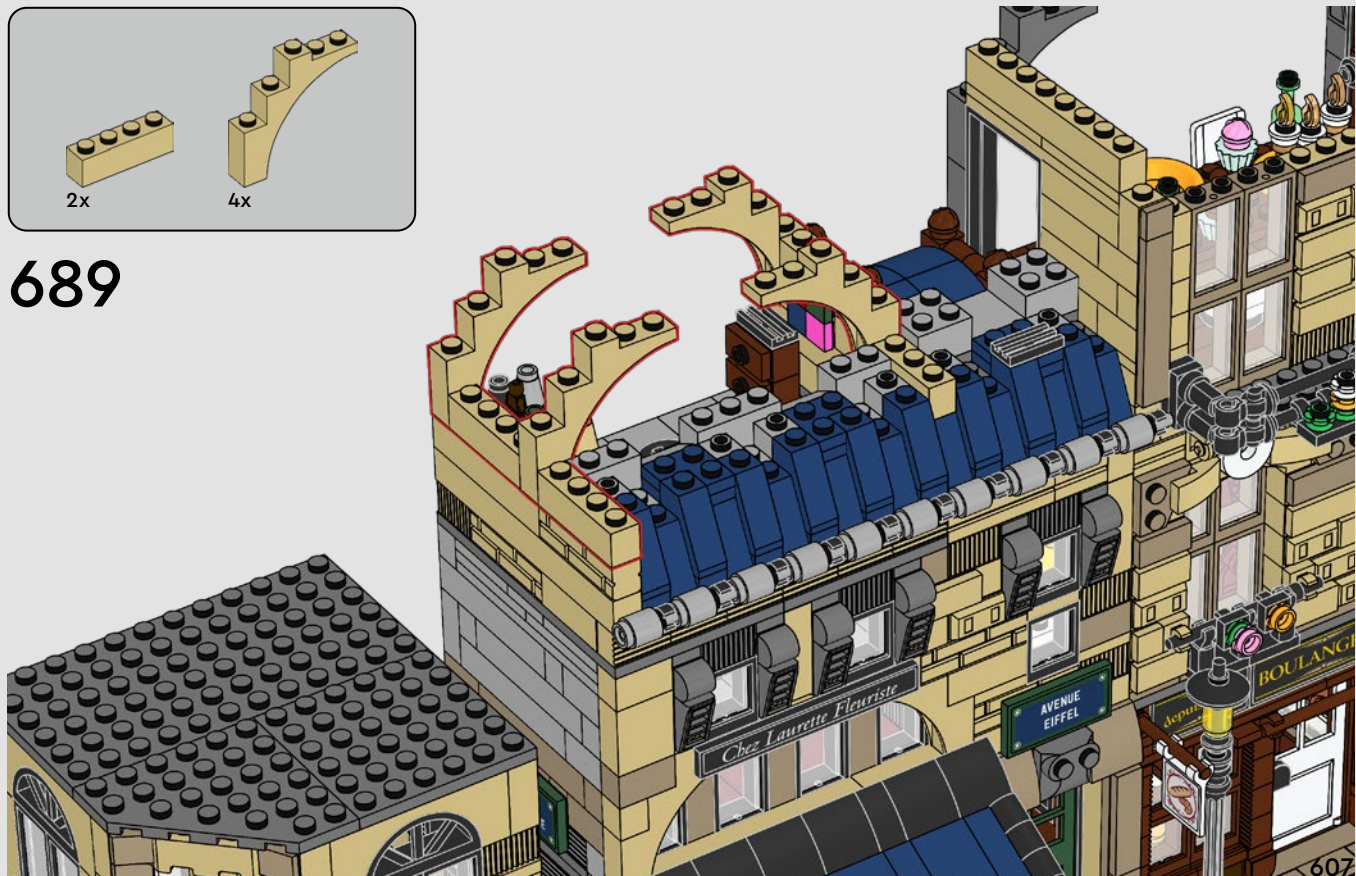



4x

690







2x



2x

691





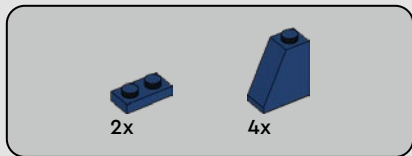

692



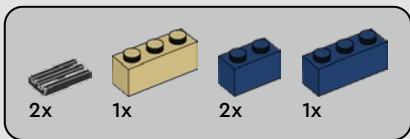

693

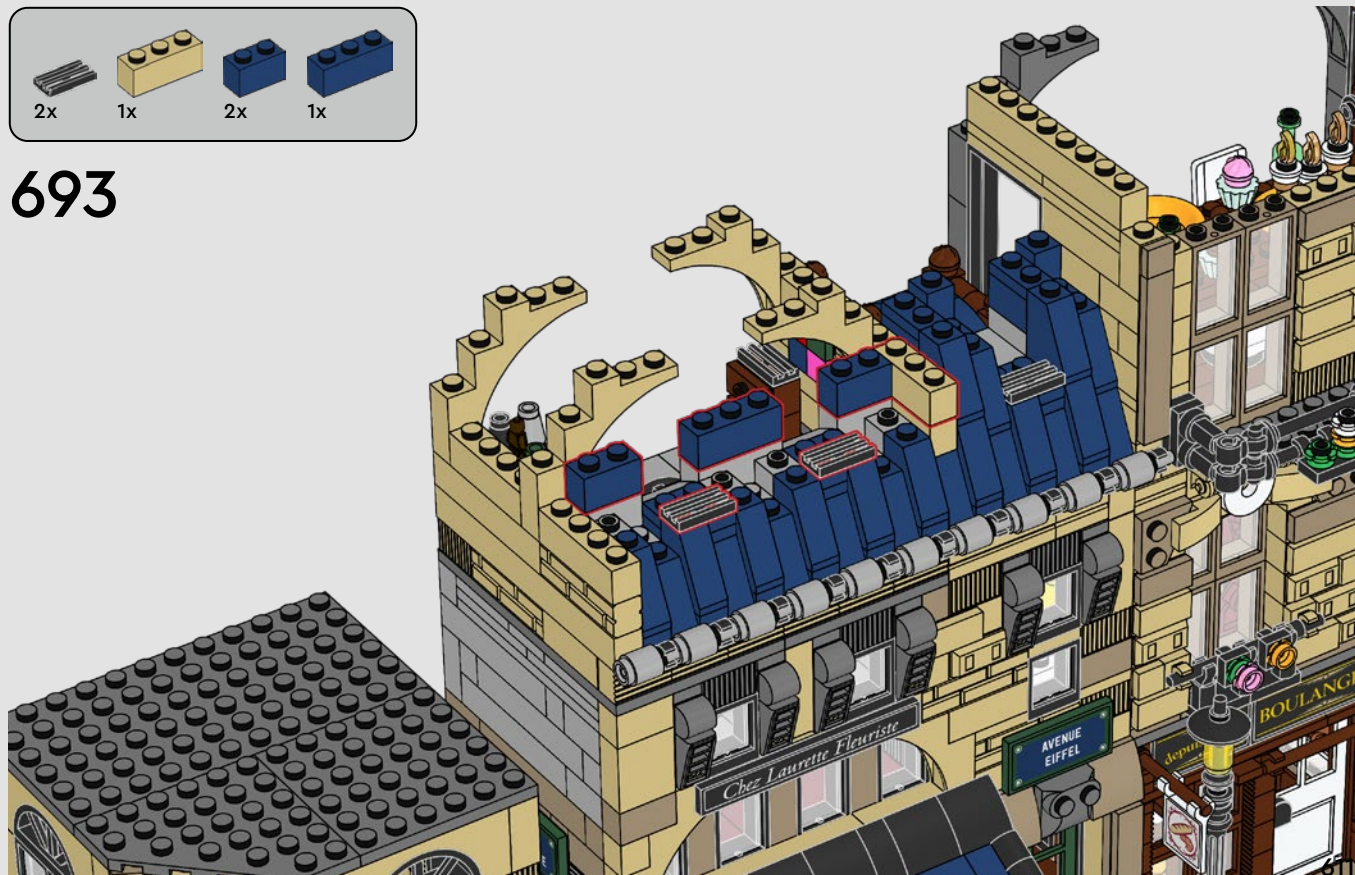

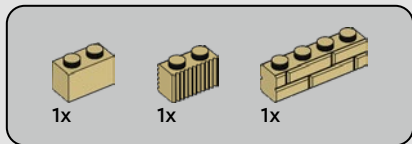

694







8x

695



4x







7x

696



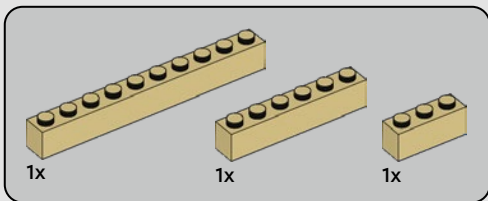

697

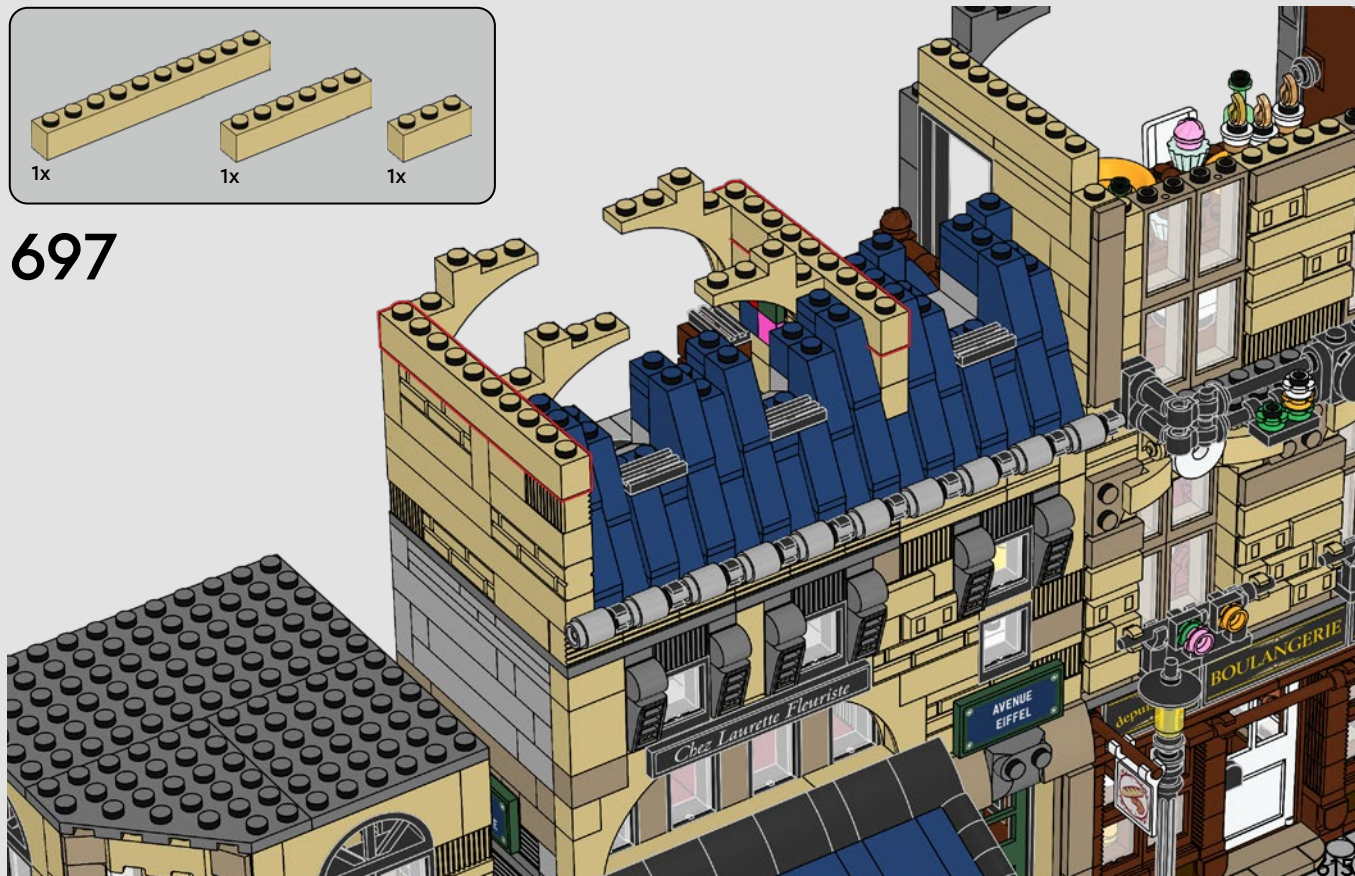



4x

698





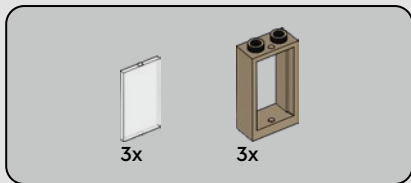

699

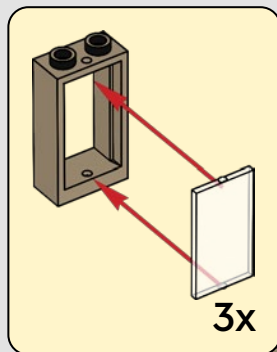





2x

700





1x



2x

# 701







2x

702



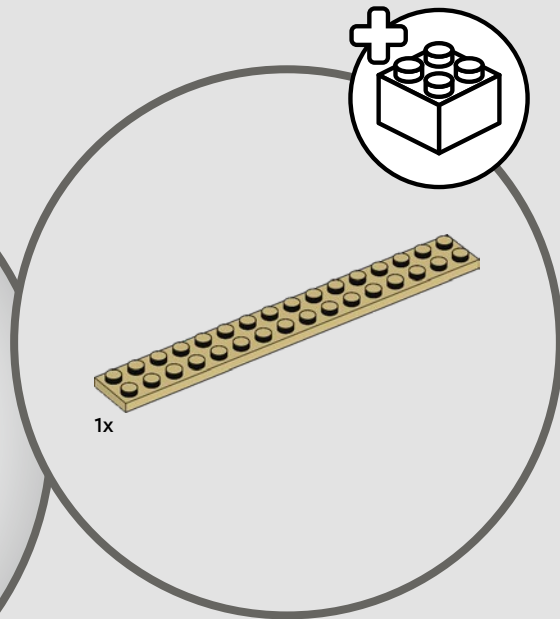



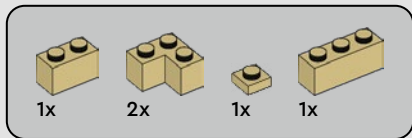

703





3x



4x

# 704





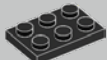

2x



4x

# 705



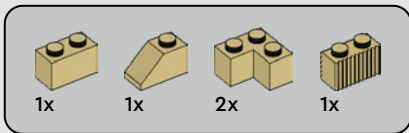

706

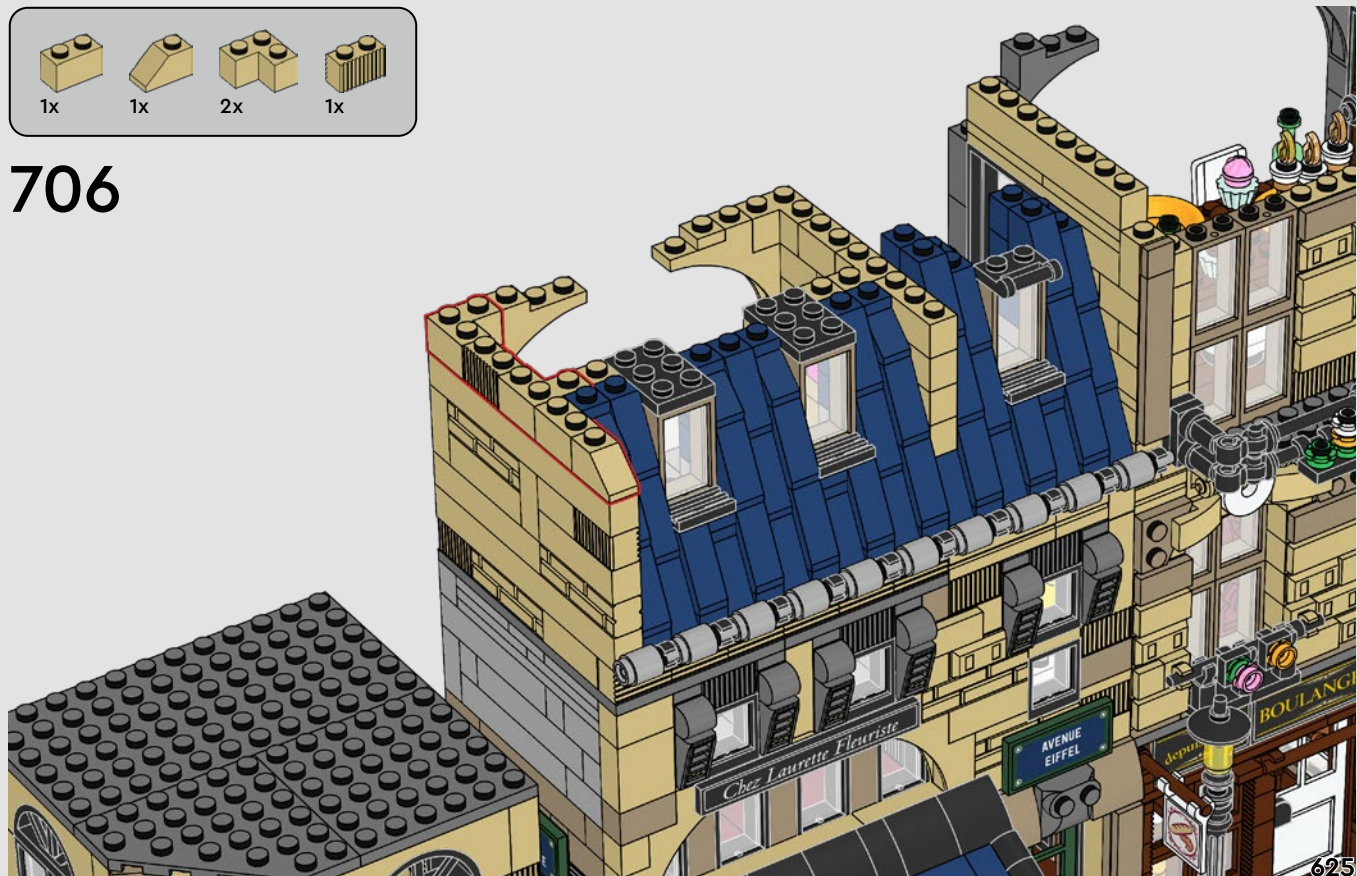



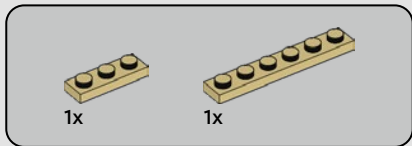

707

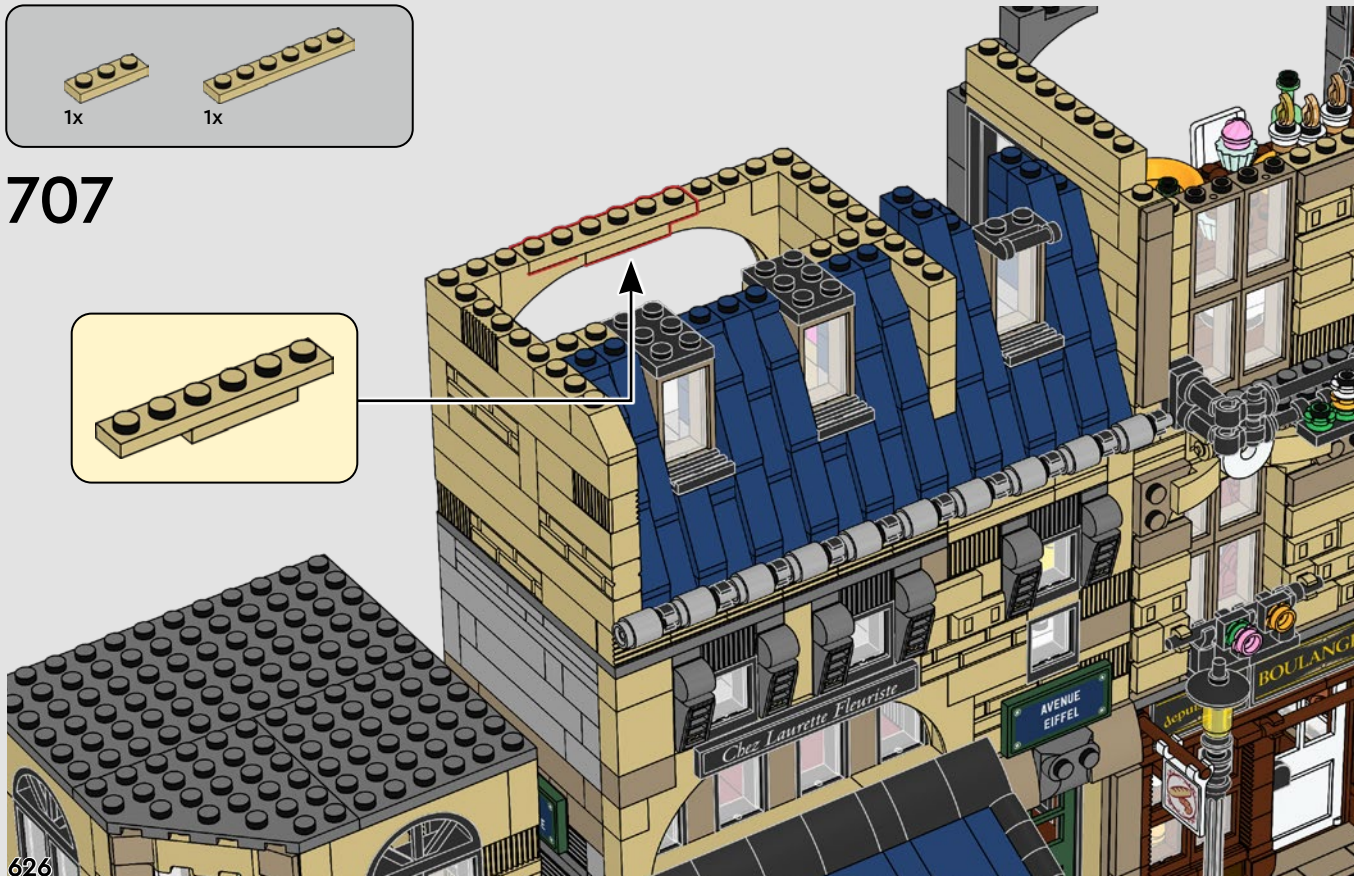
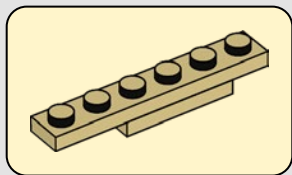

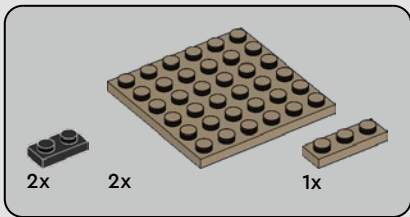

708

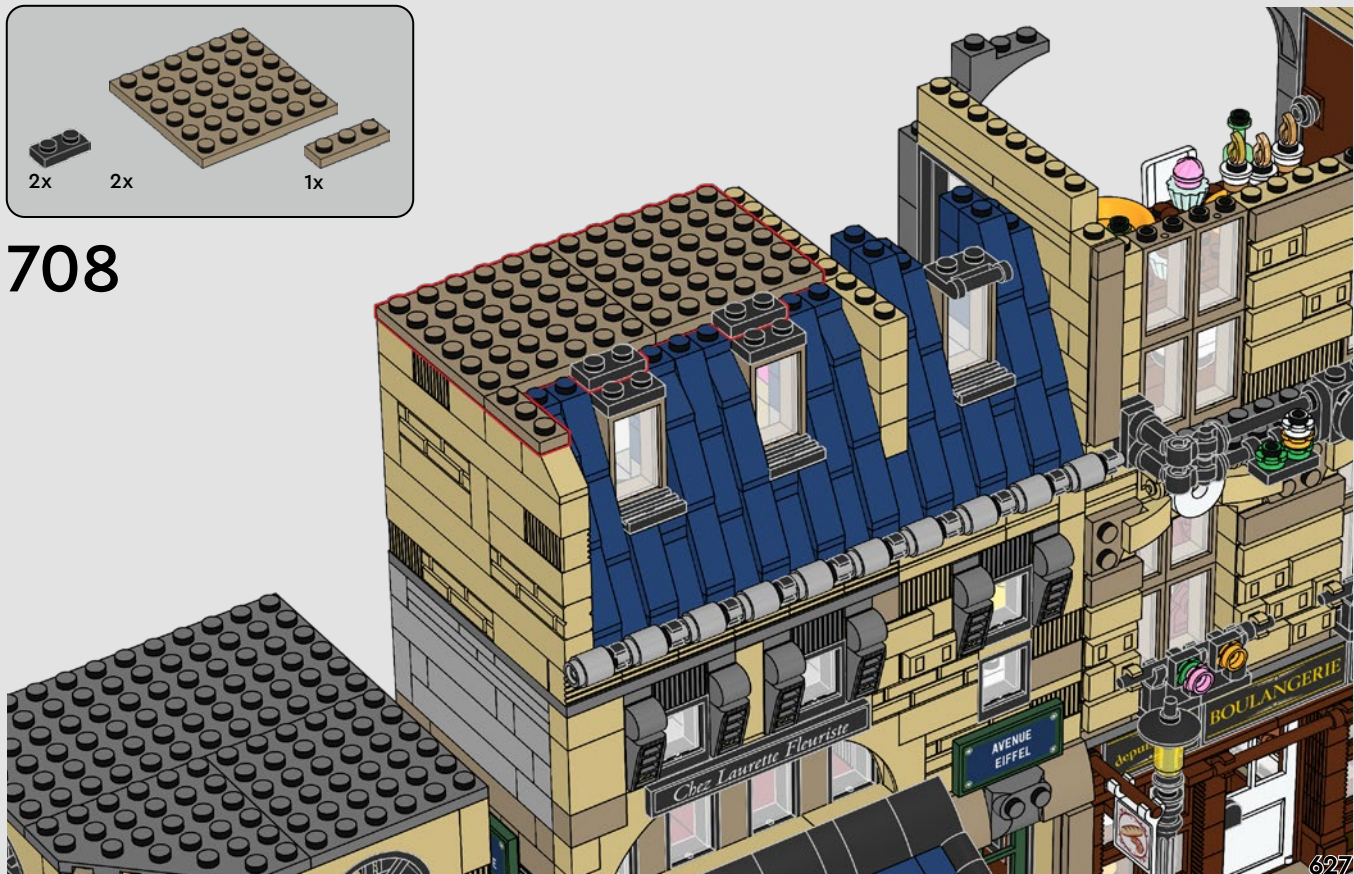



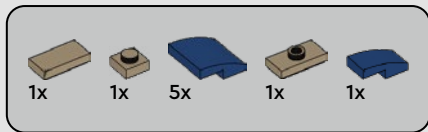

709

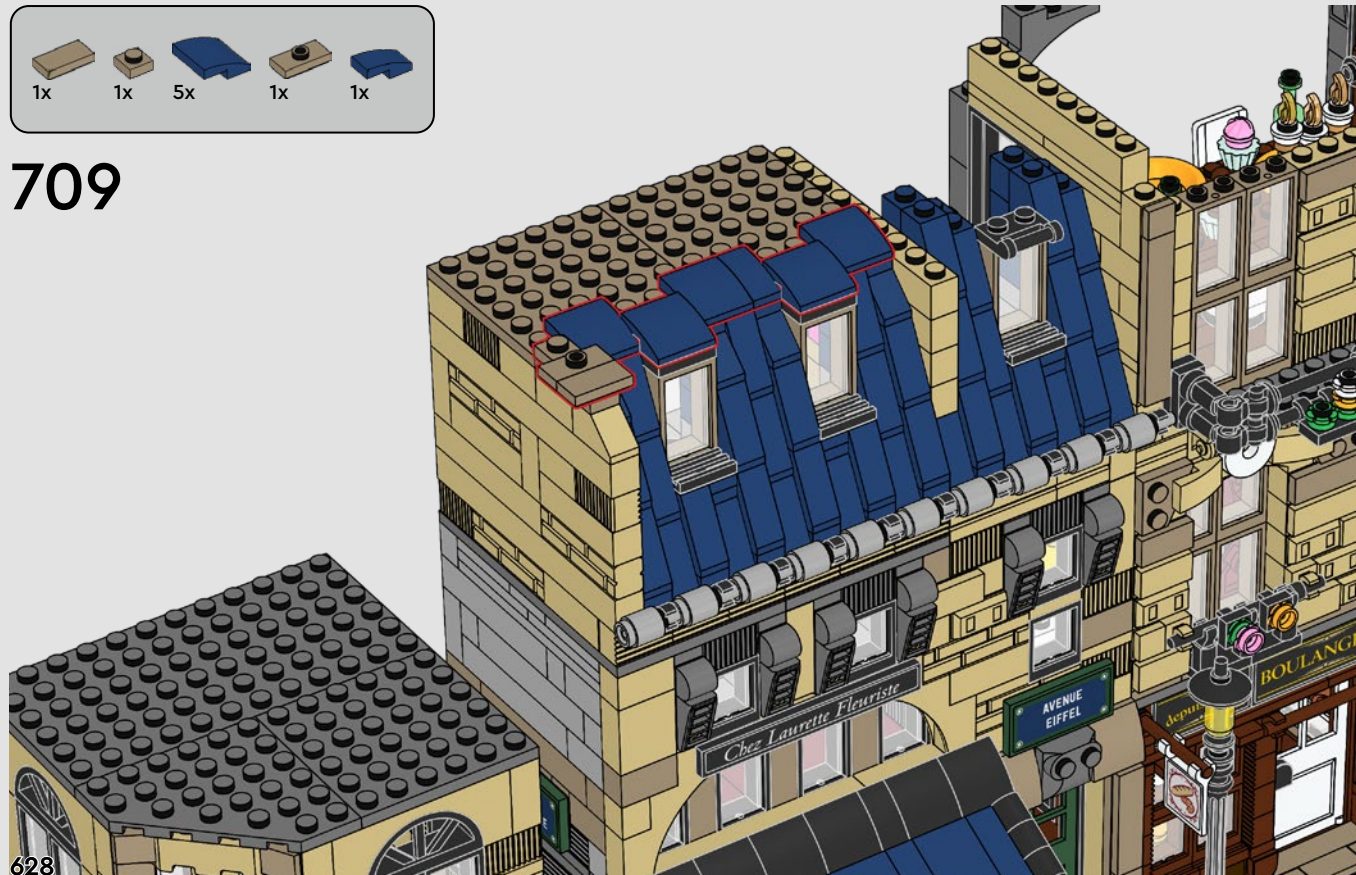

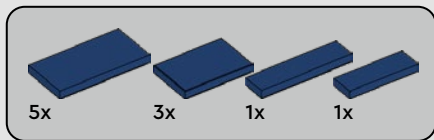

710

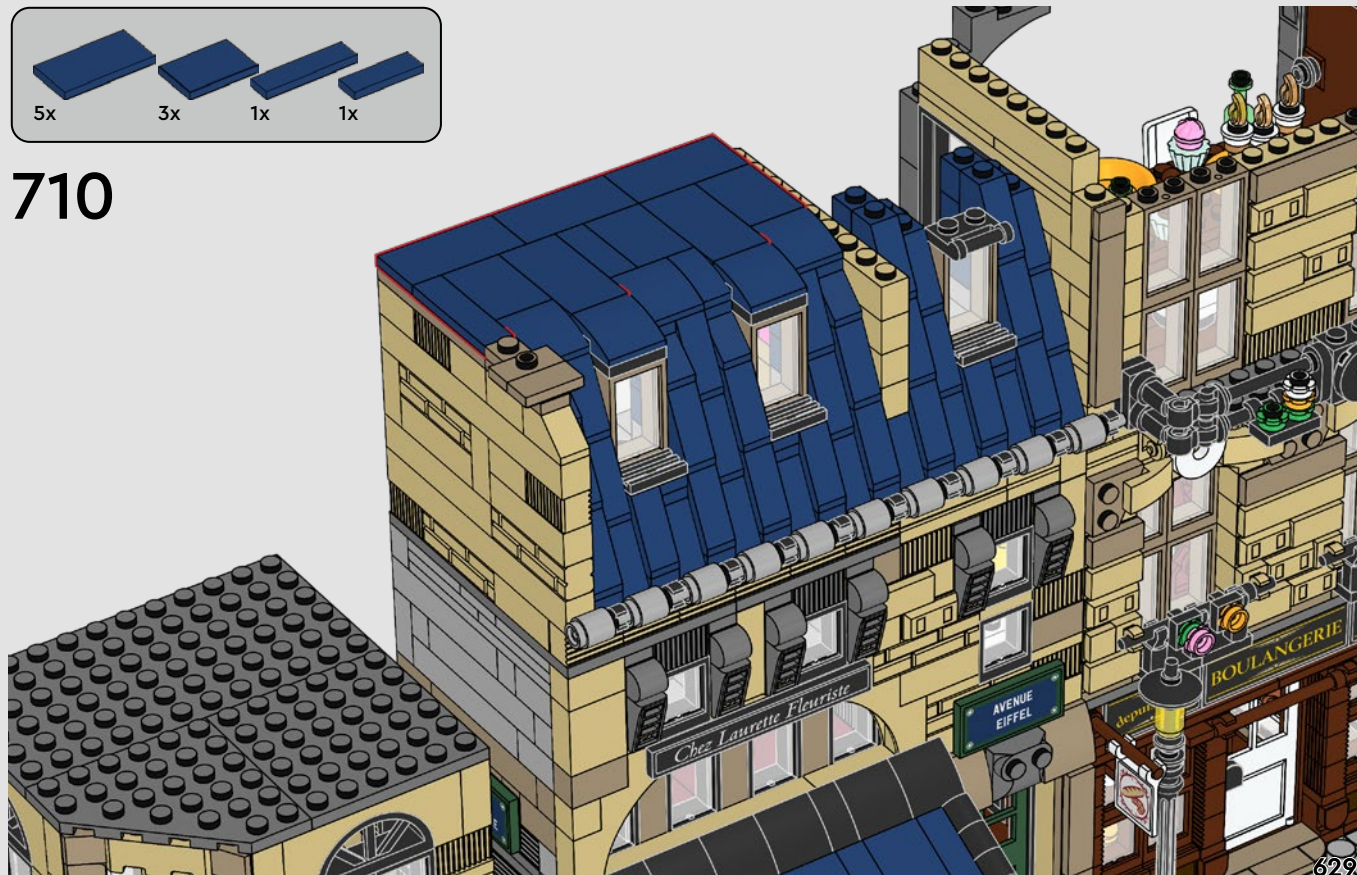



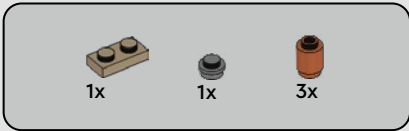

711

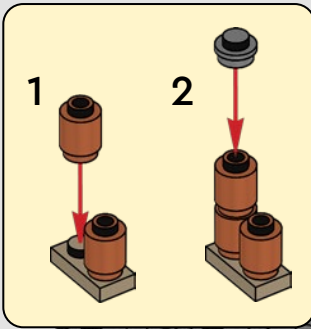



2x



1x

# 712

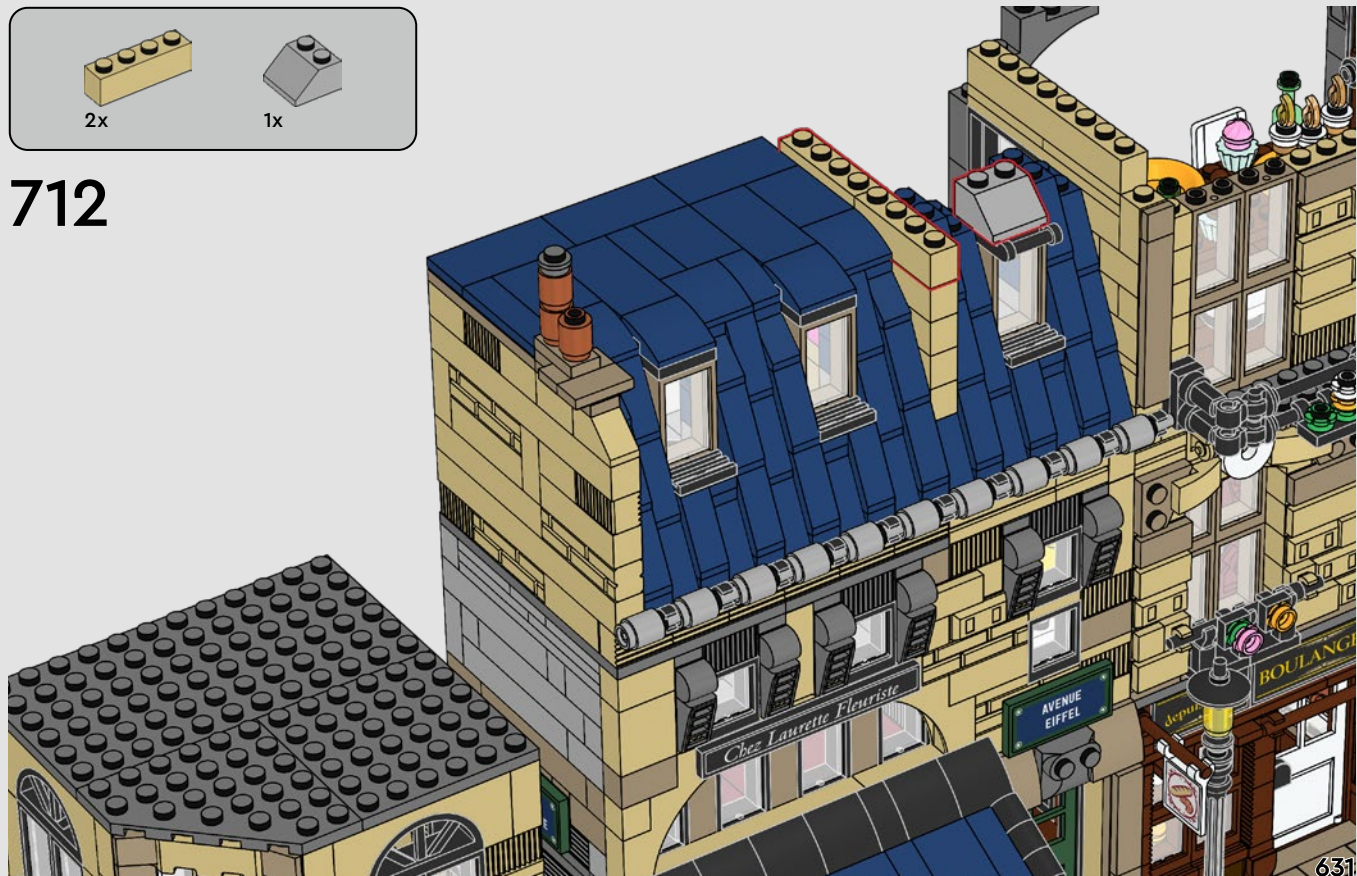



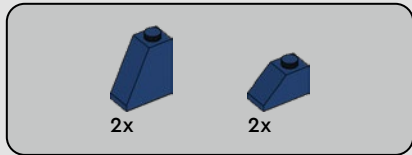

713

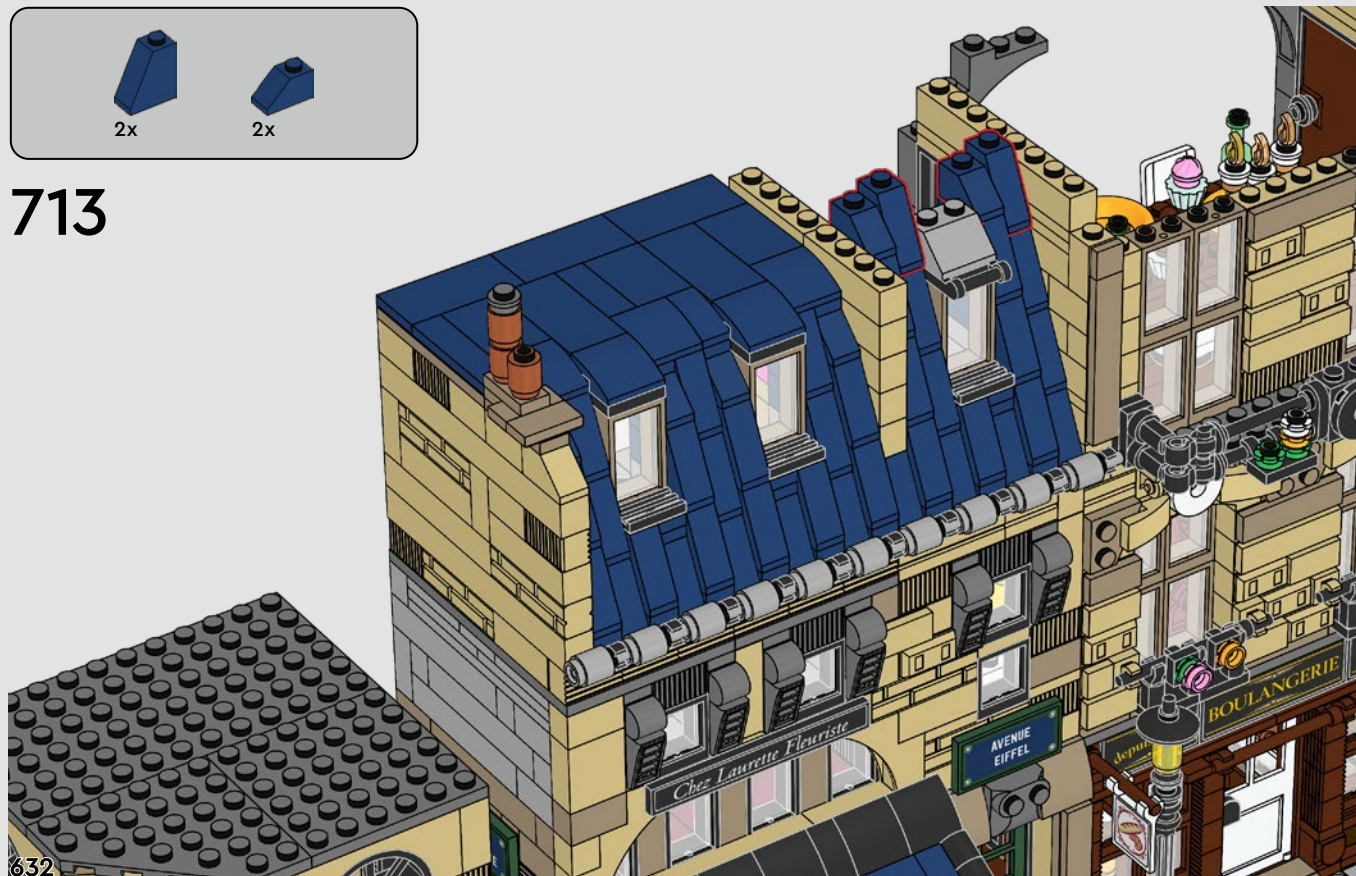

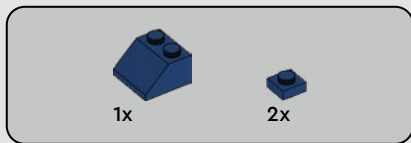

714





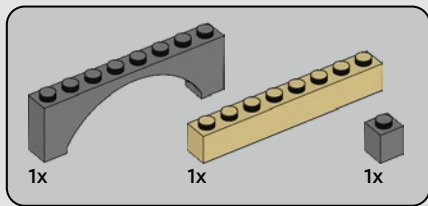

715

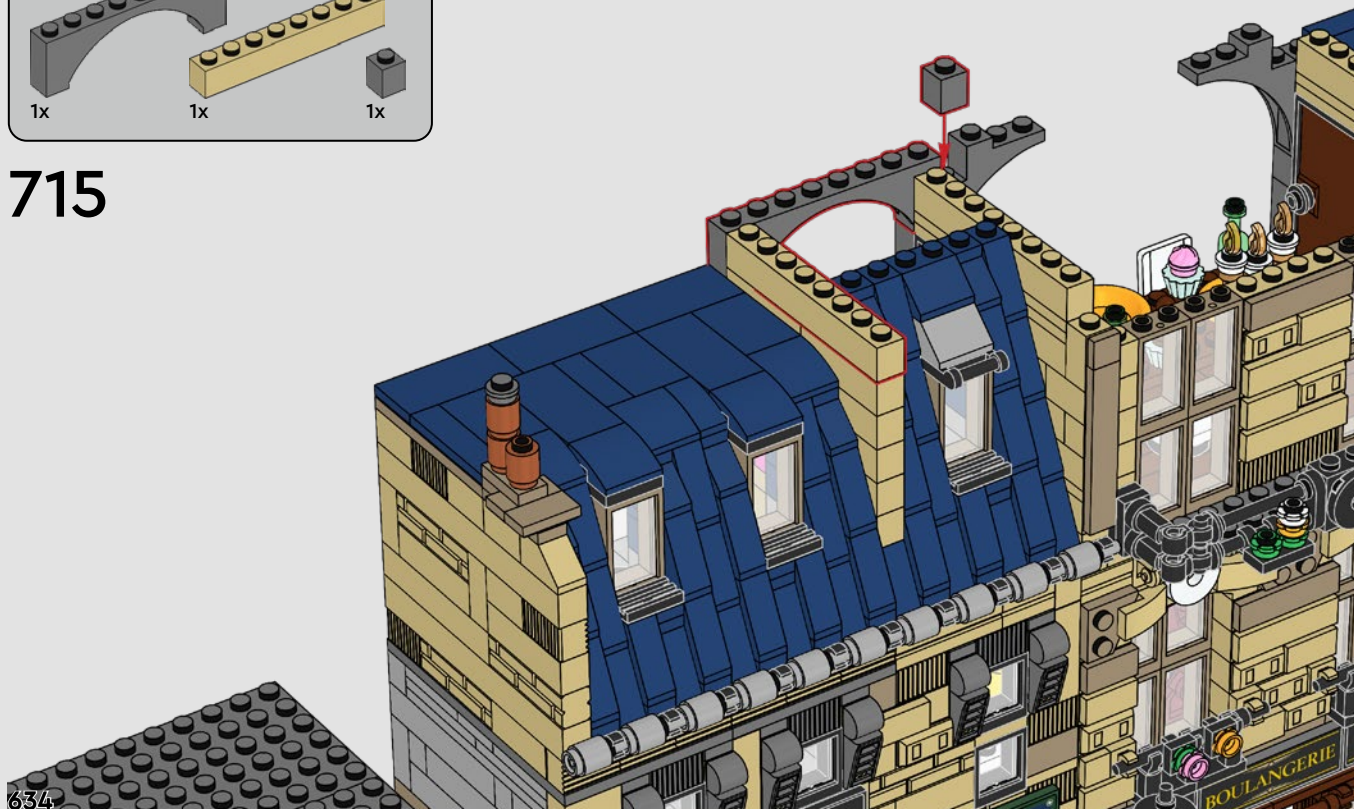

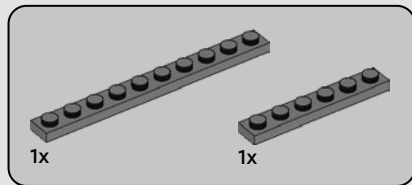

716

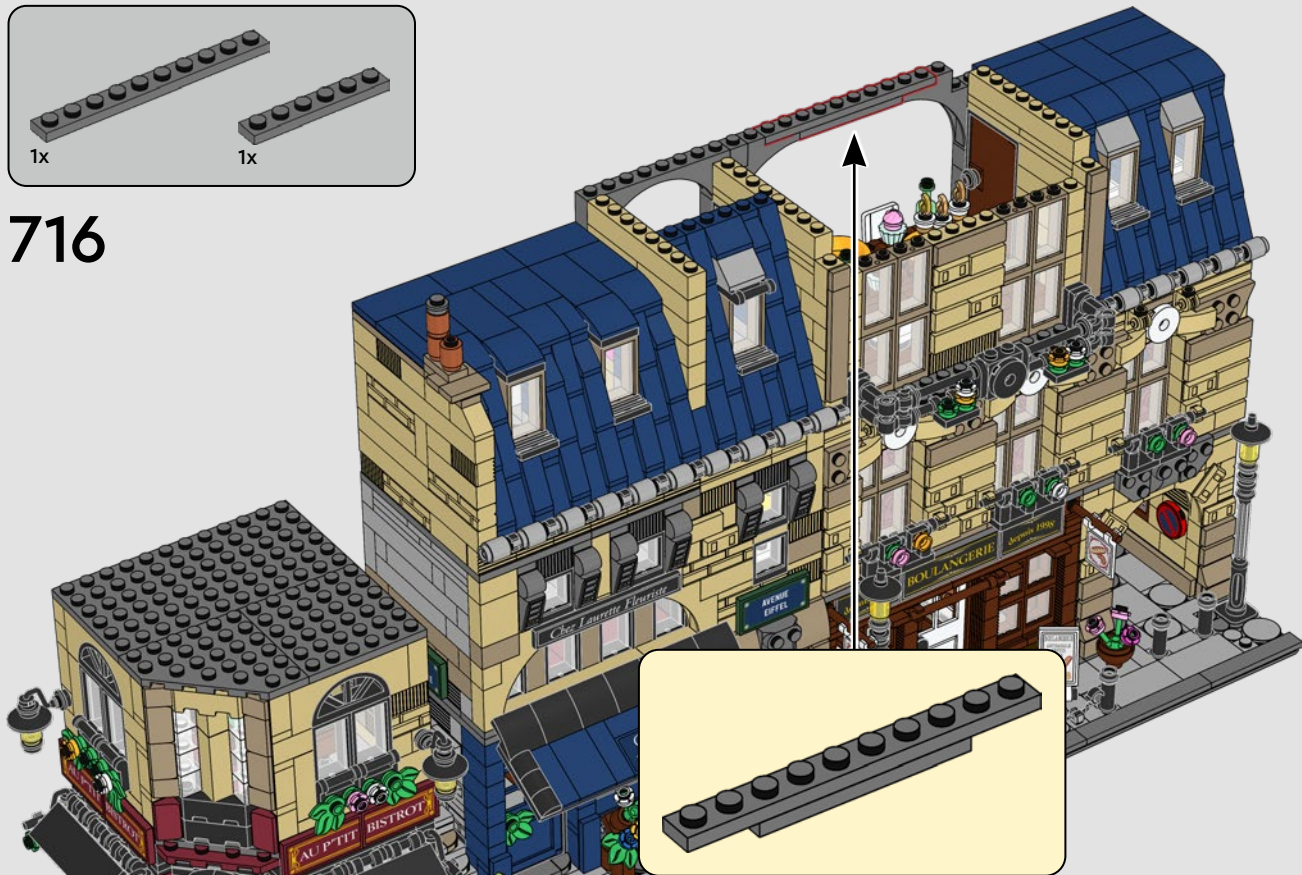

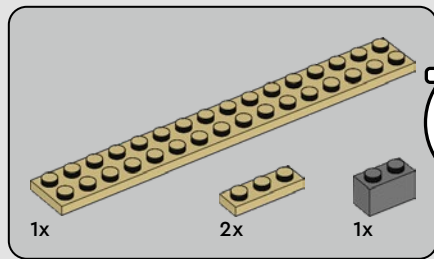

717

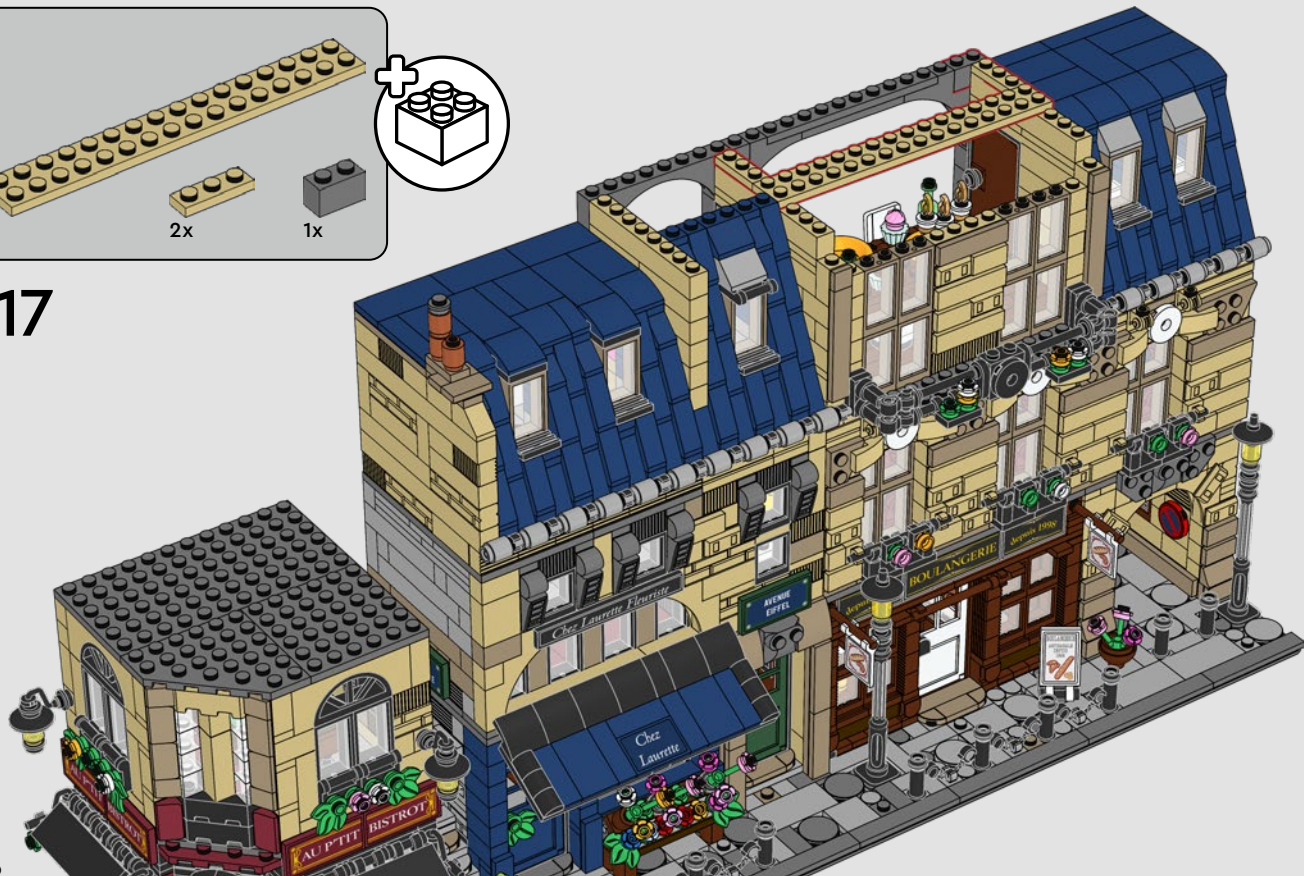



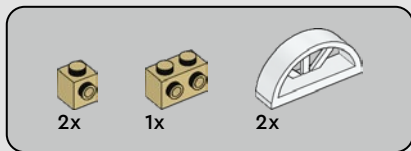

718





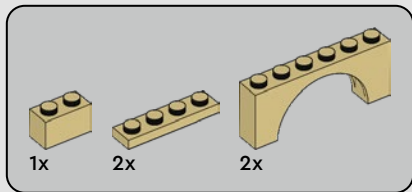

719



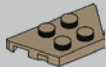

1x



2x

# 720





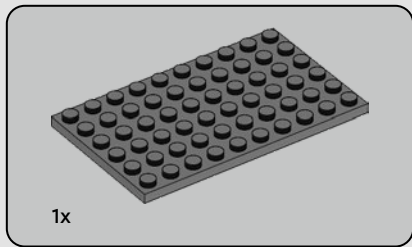

721

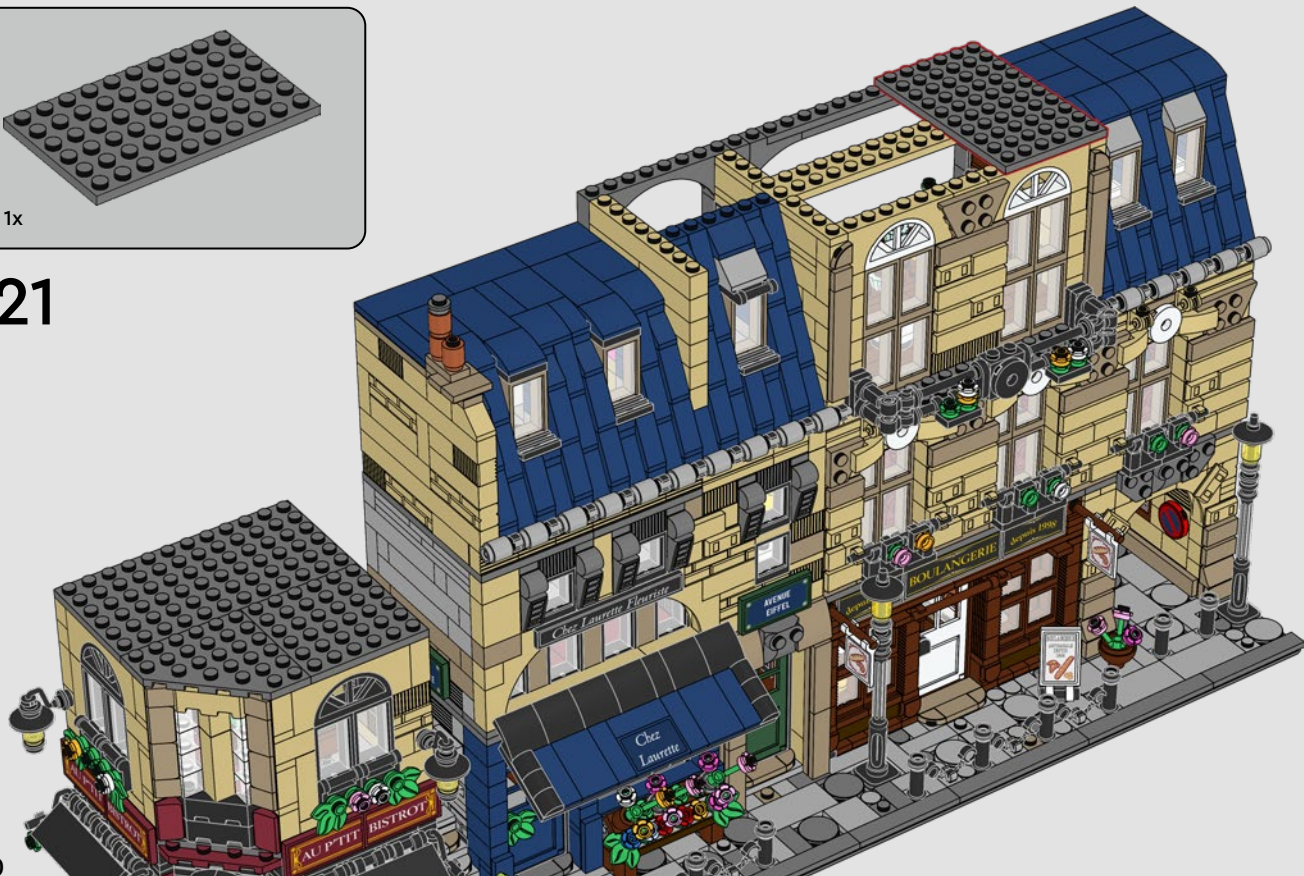

640

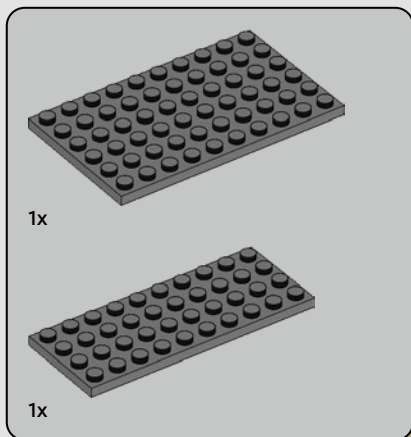

722

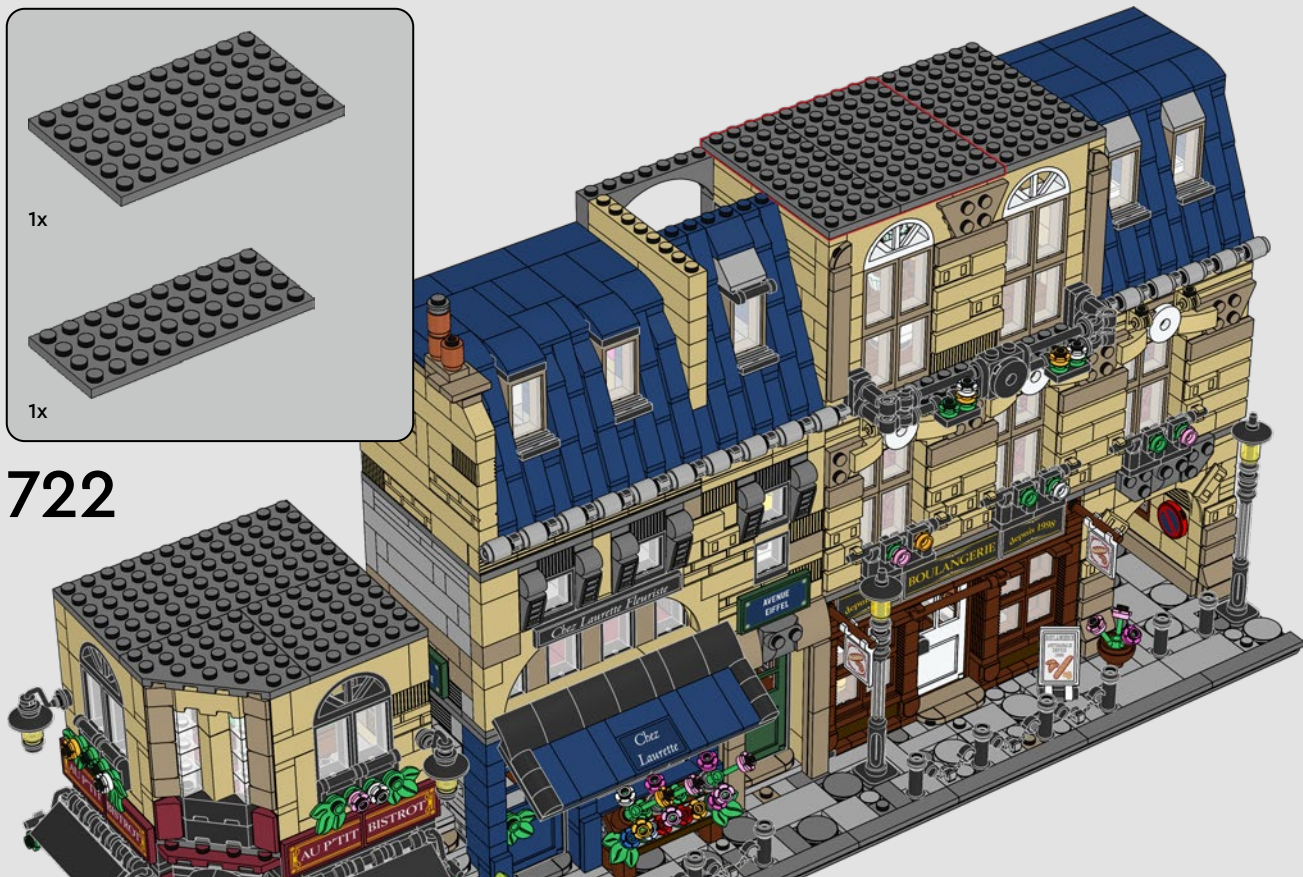



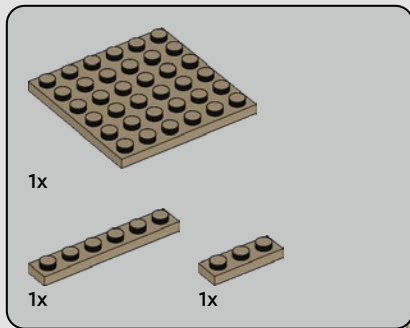

723



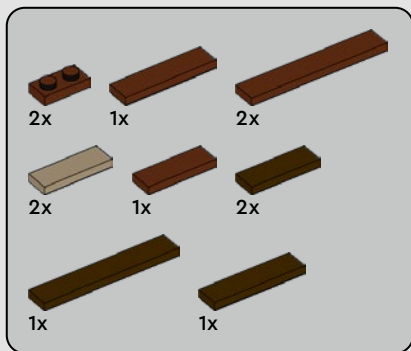

724



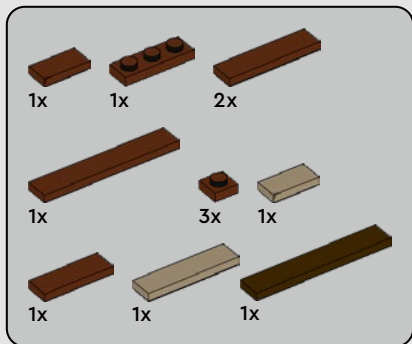

725





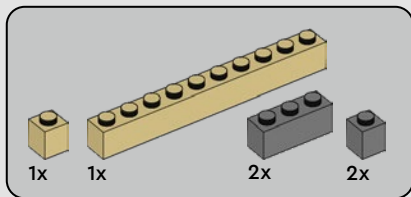

726







2x



2x



2x

# 727





4x

728





2x



2x



4x

# 729





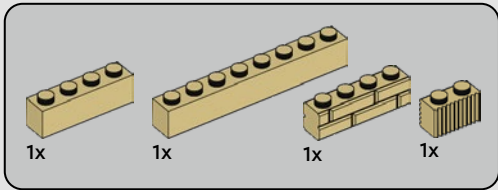

730

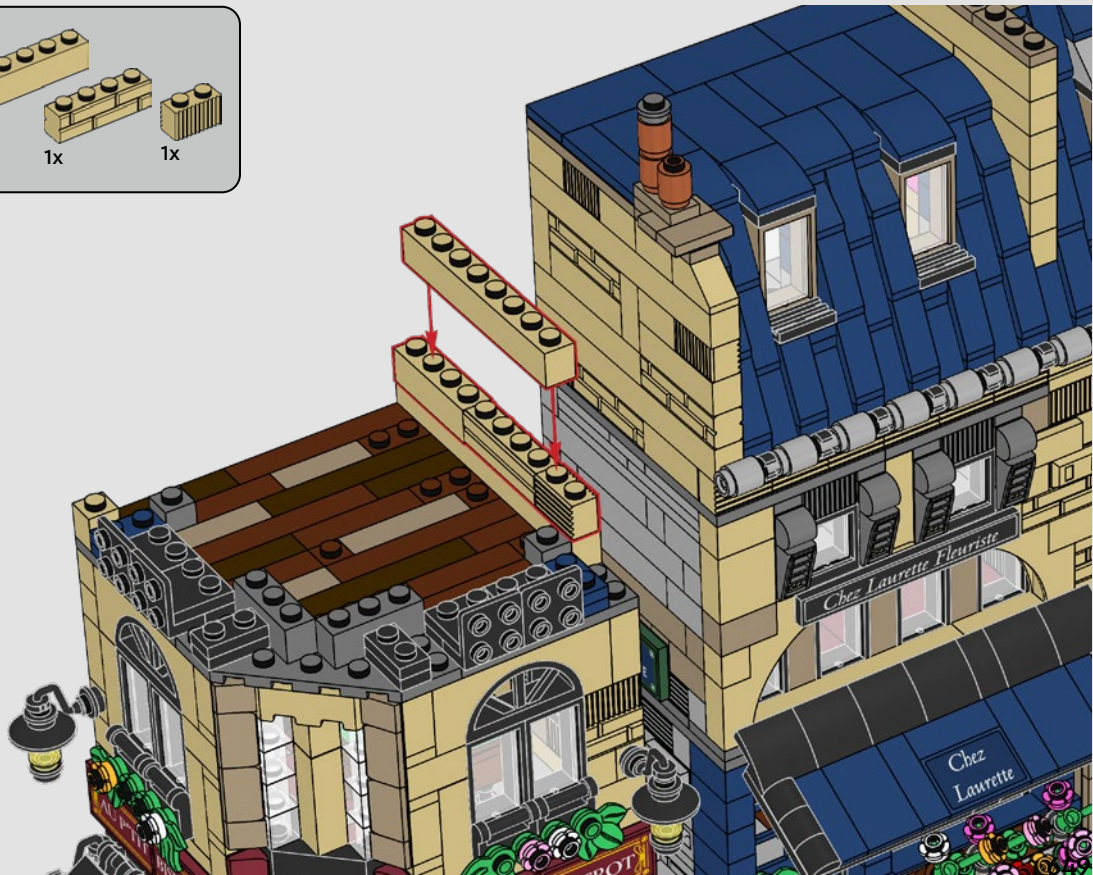





1x



2x

731



2x

732

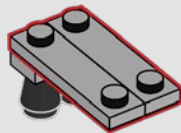



1x



2x

# 733

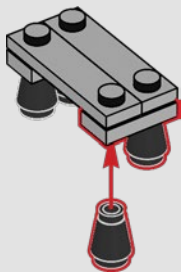

1x



1x

# 734

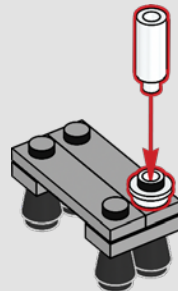

1x

# 735



736



652



737

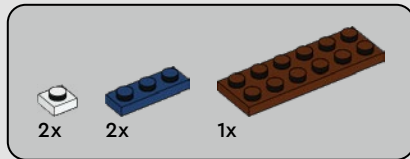
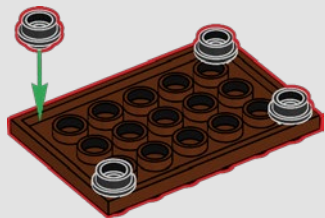

738







739

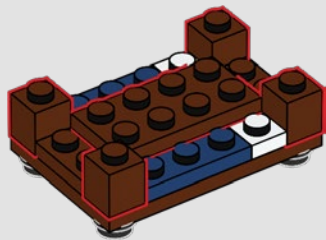

740

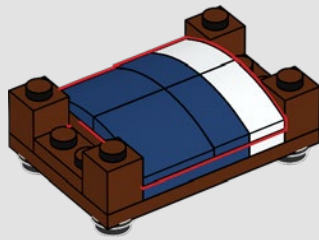



2x



1x

741

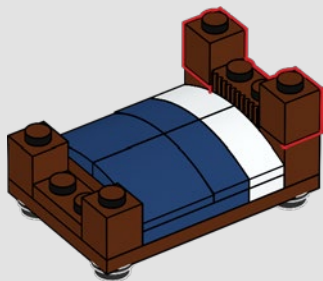

4x

742

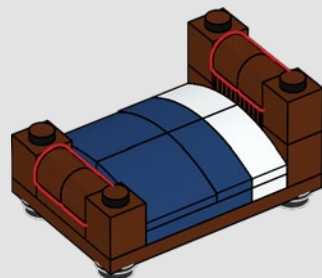

4x

743

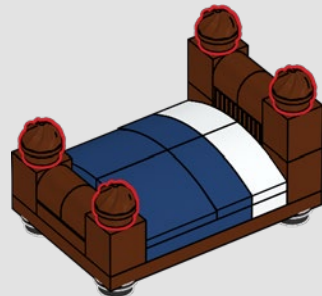

744



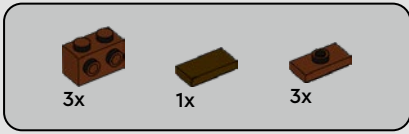

745

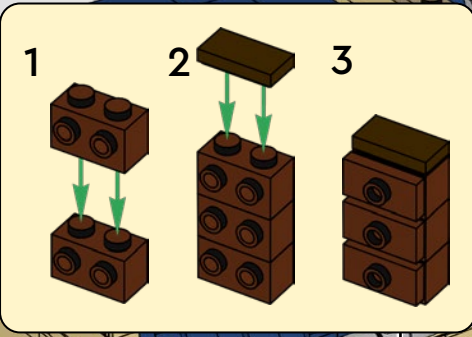



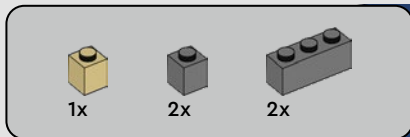

746

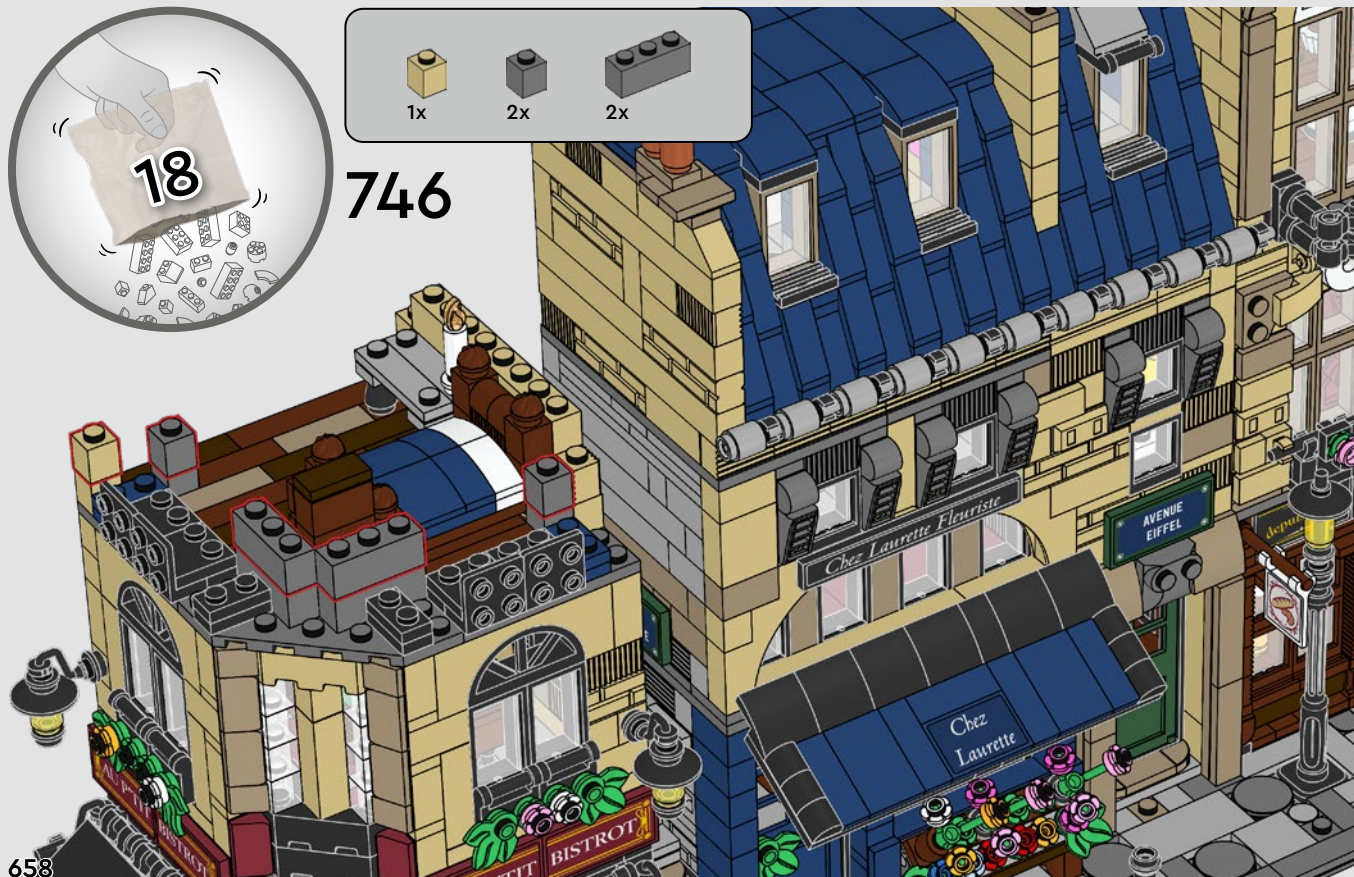

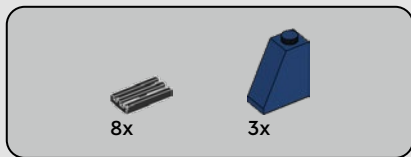

747







8x

748



4x





2x



4x

749





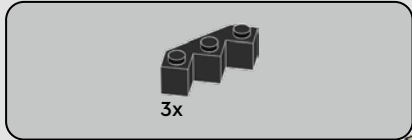

750

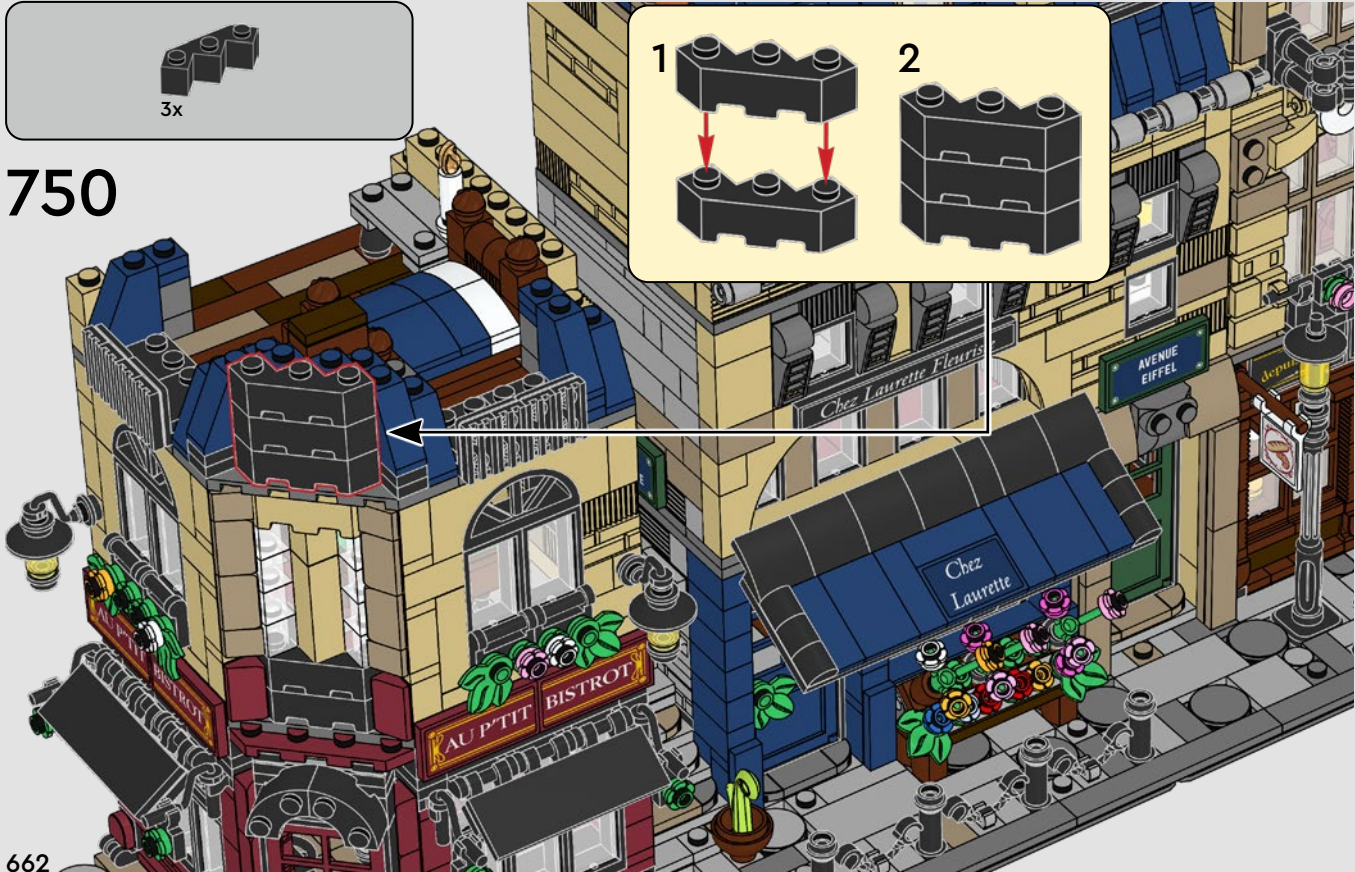
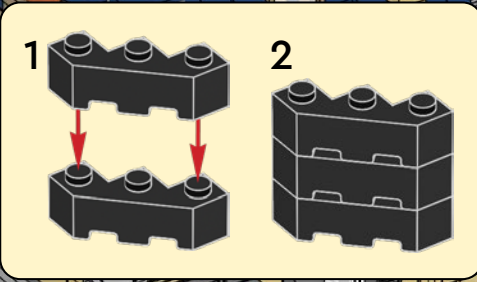

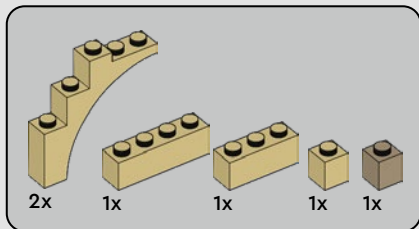

751

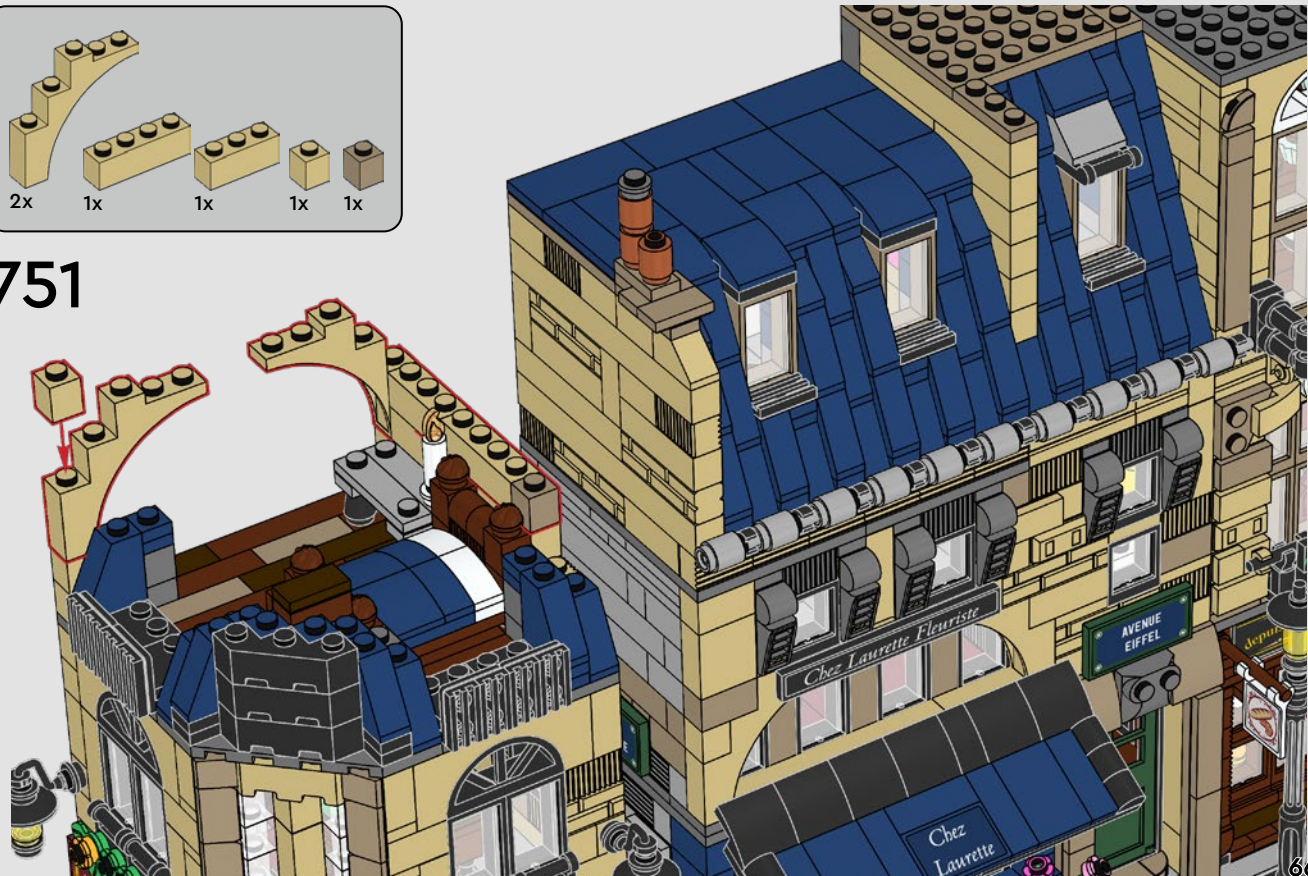



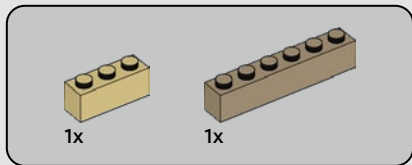

752



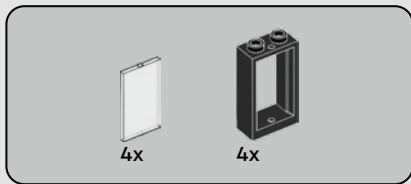

753

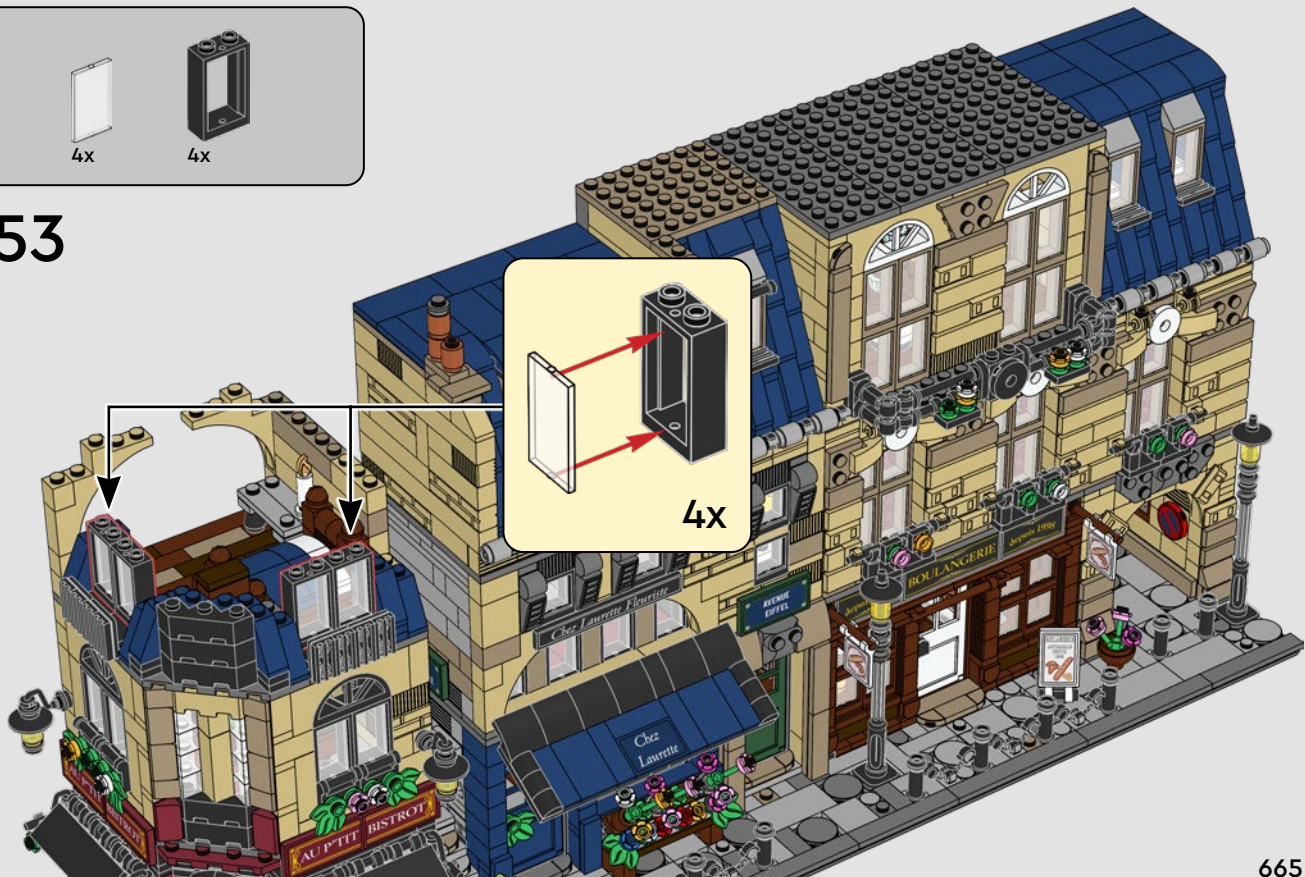



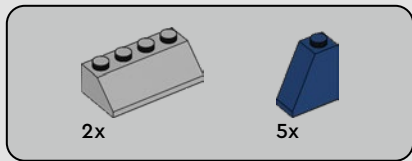

754





6x

755



3x







4x

# 756





2x

757





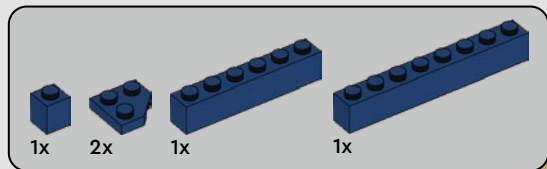

758

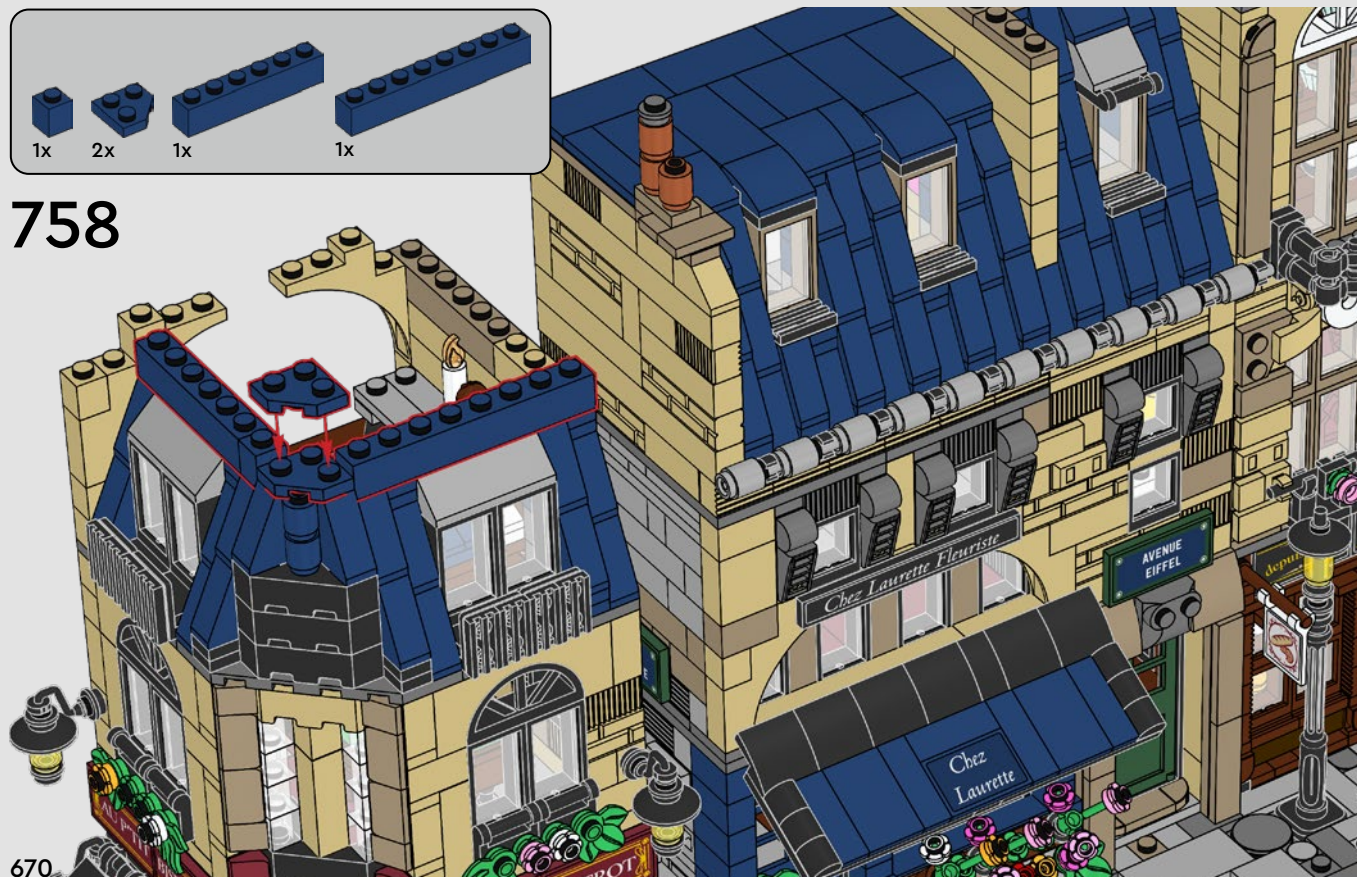

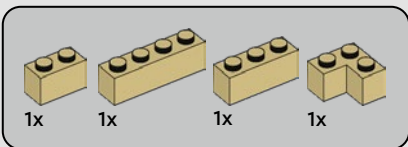

759





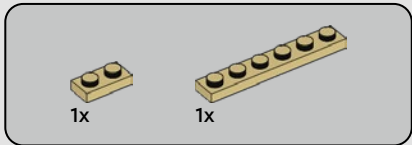

760

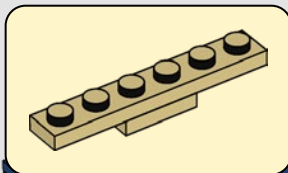

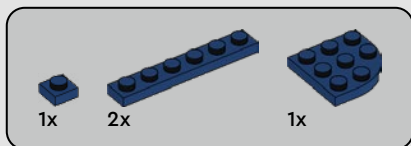

761





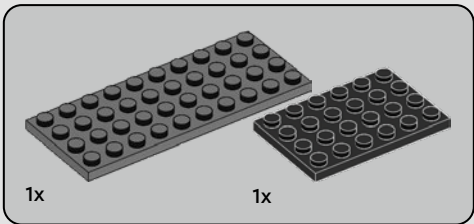
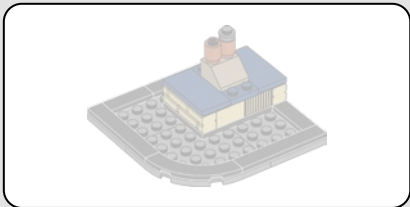

762

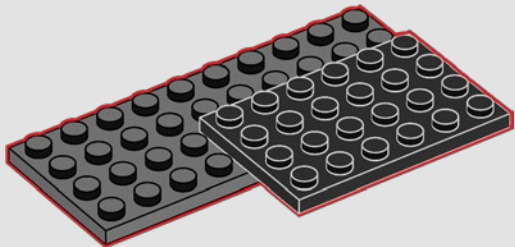

674

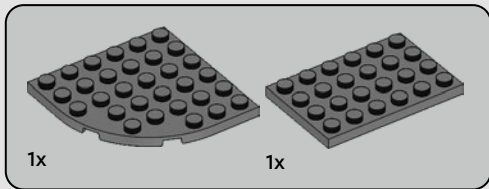

763

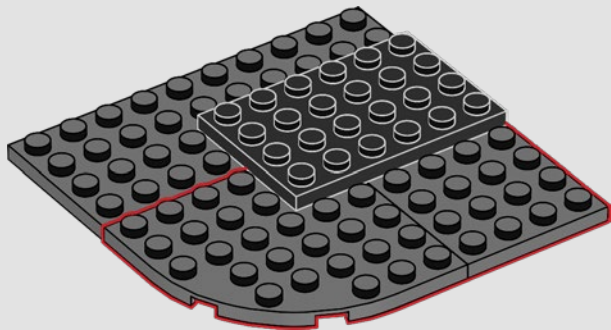

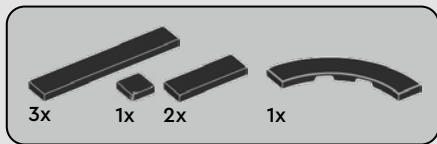

764

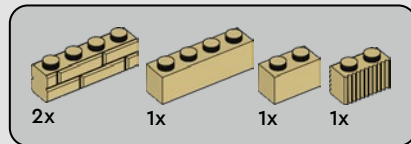
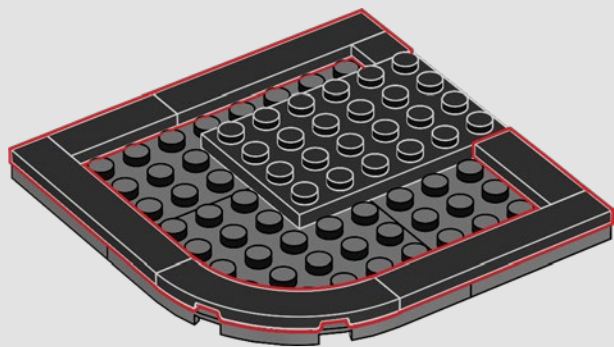

765

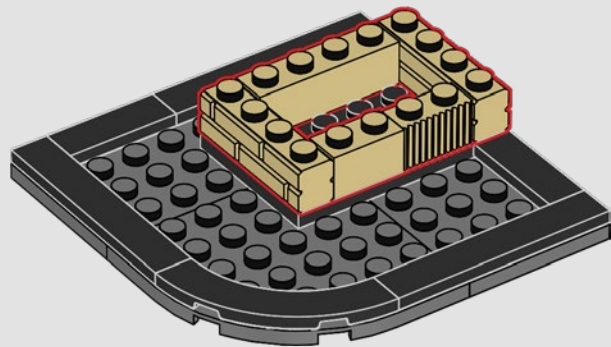

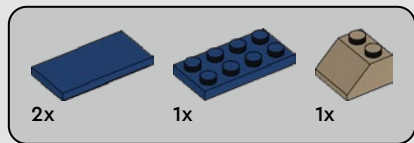

766

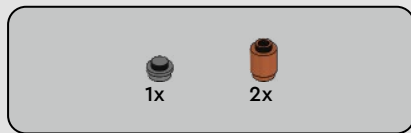
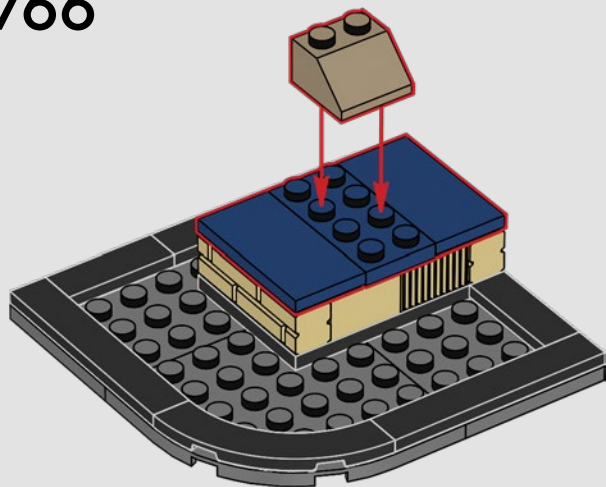

767

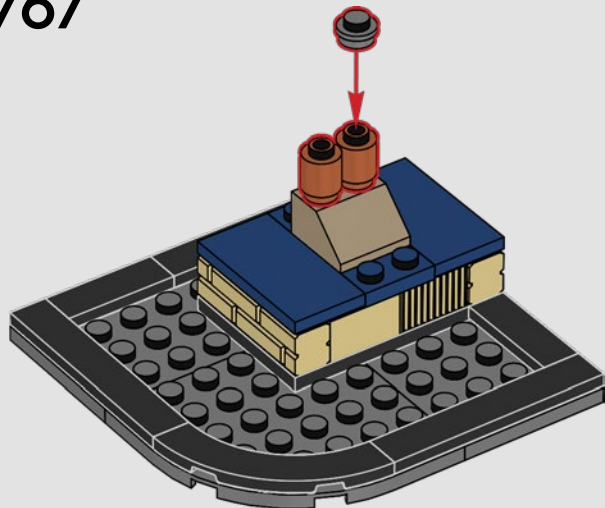

768





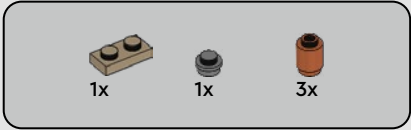

769

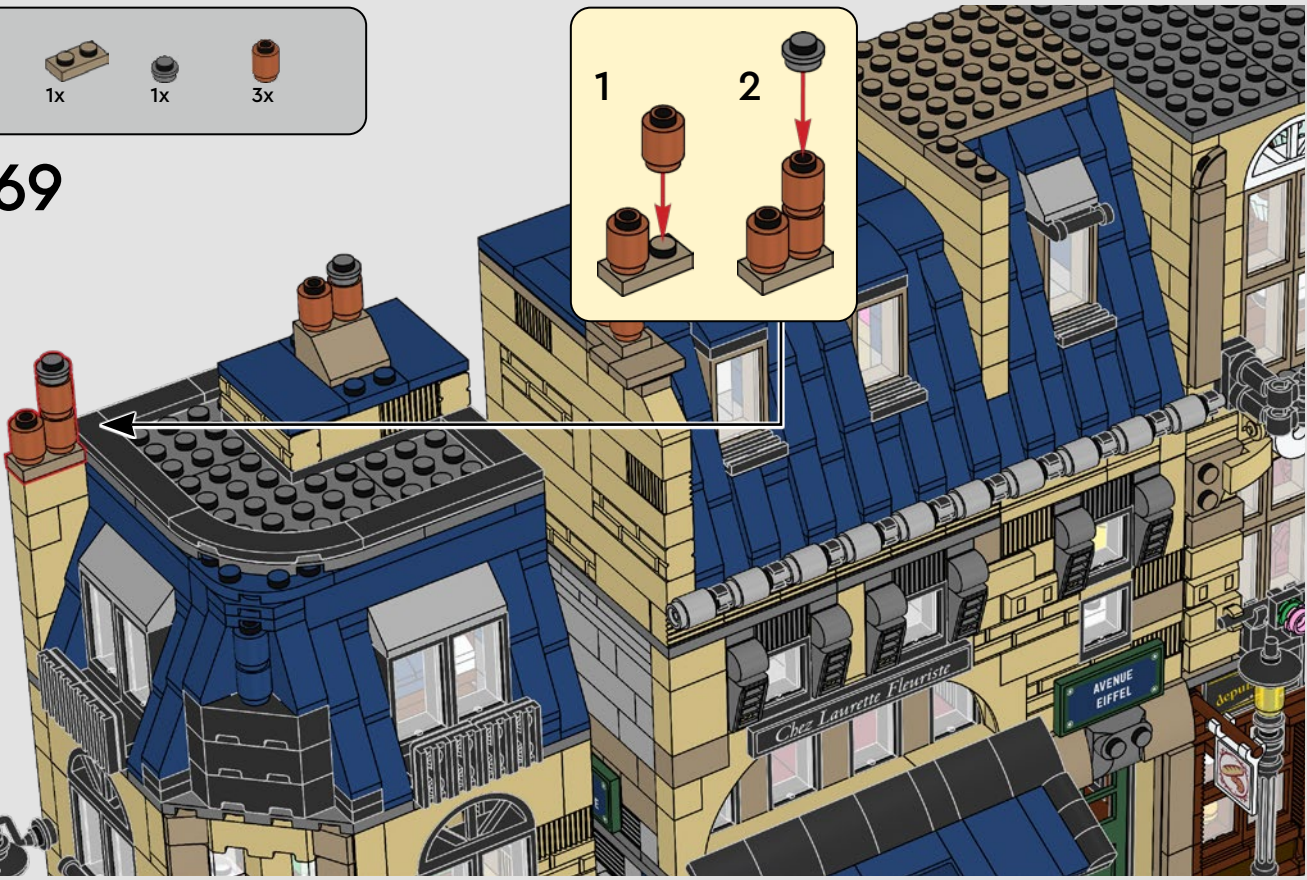
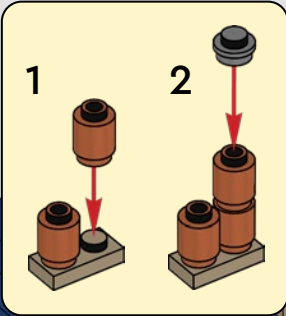



15x

770





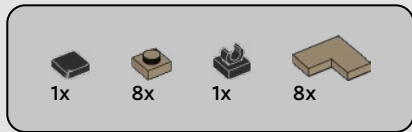

771



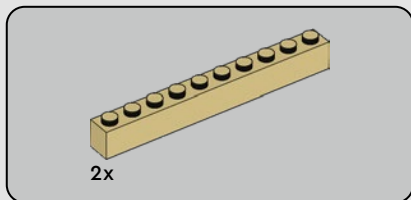

772





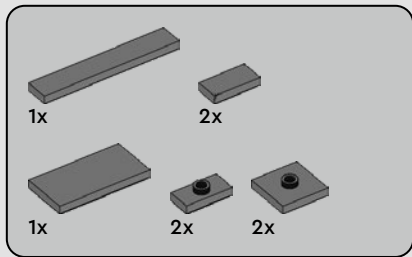

773

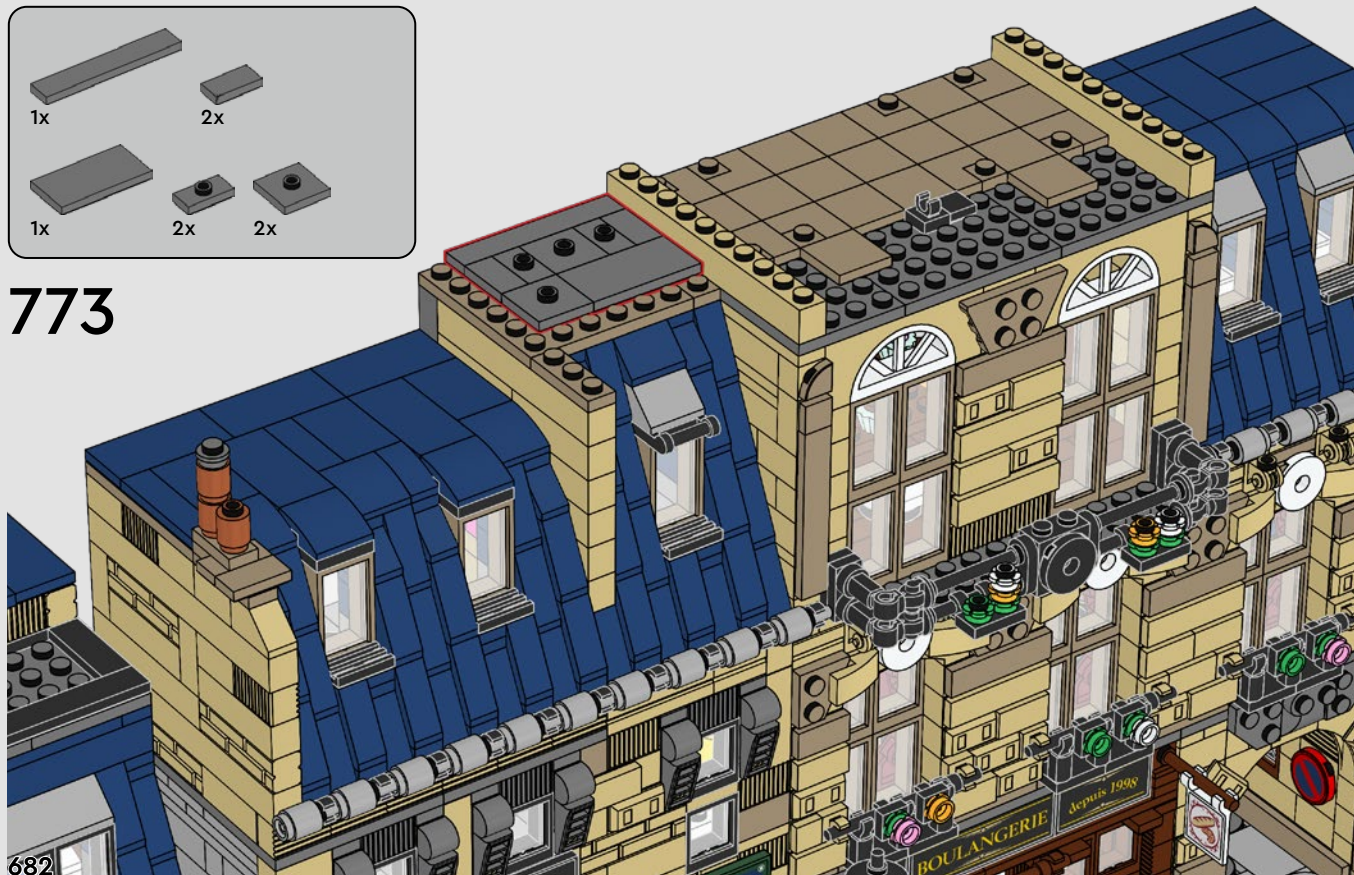



2x



1x



2x



4x

# 774





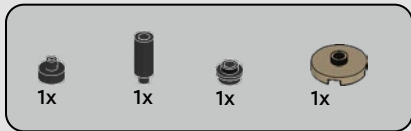

775



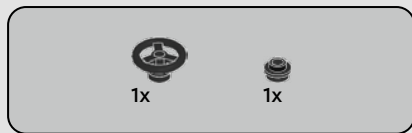

776

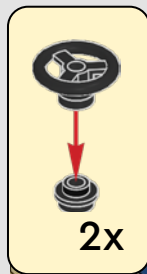



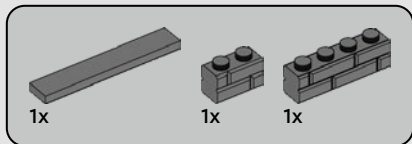

777

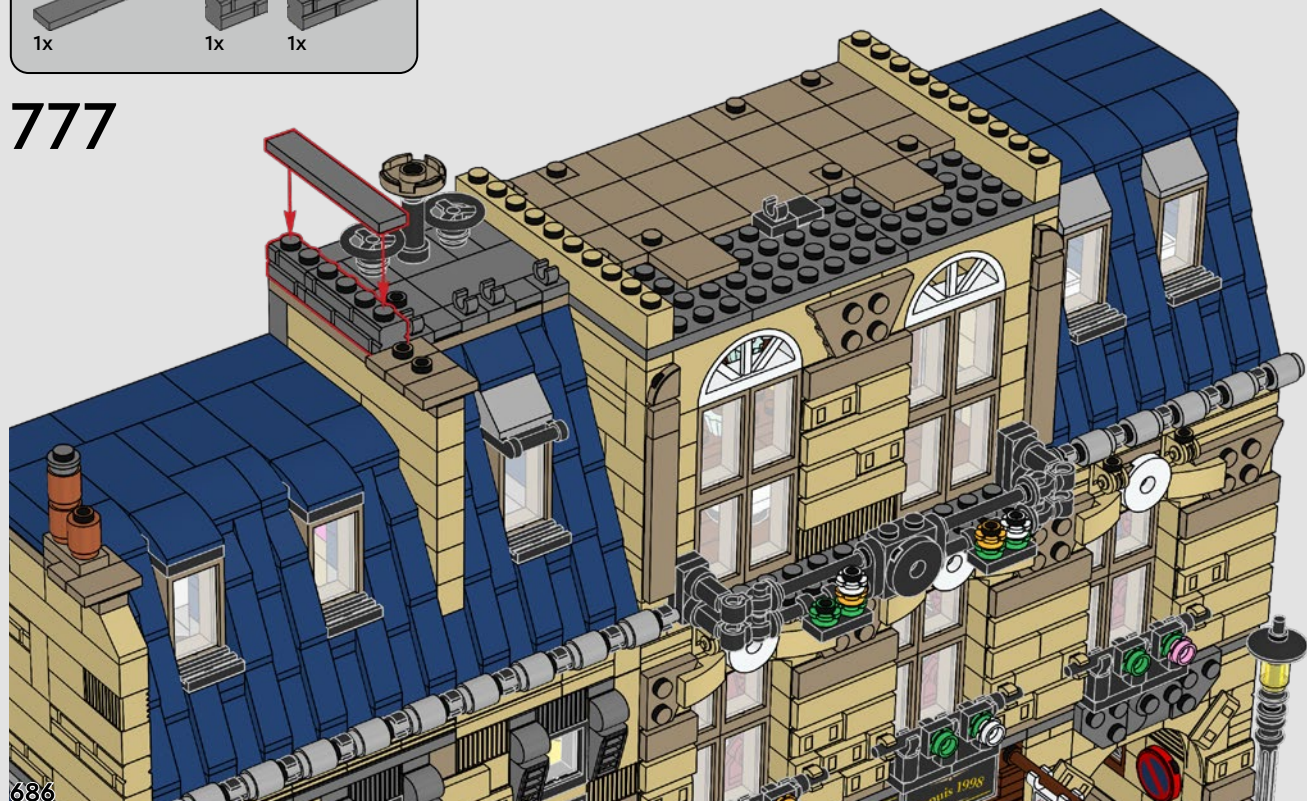



778





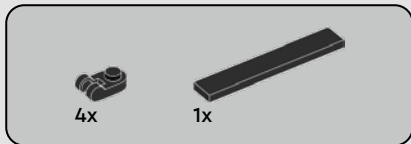

779

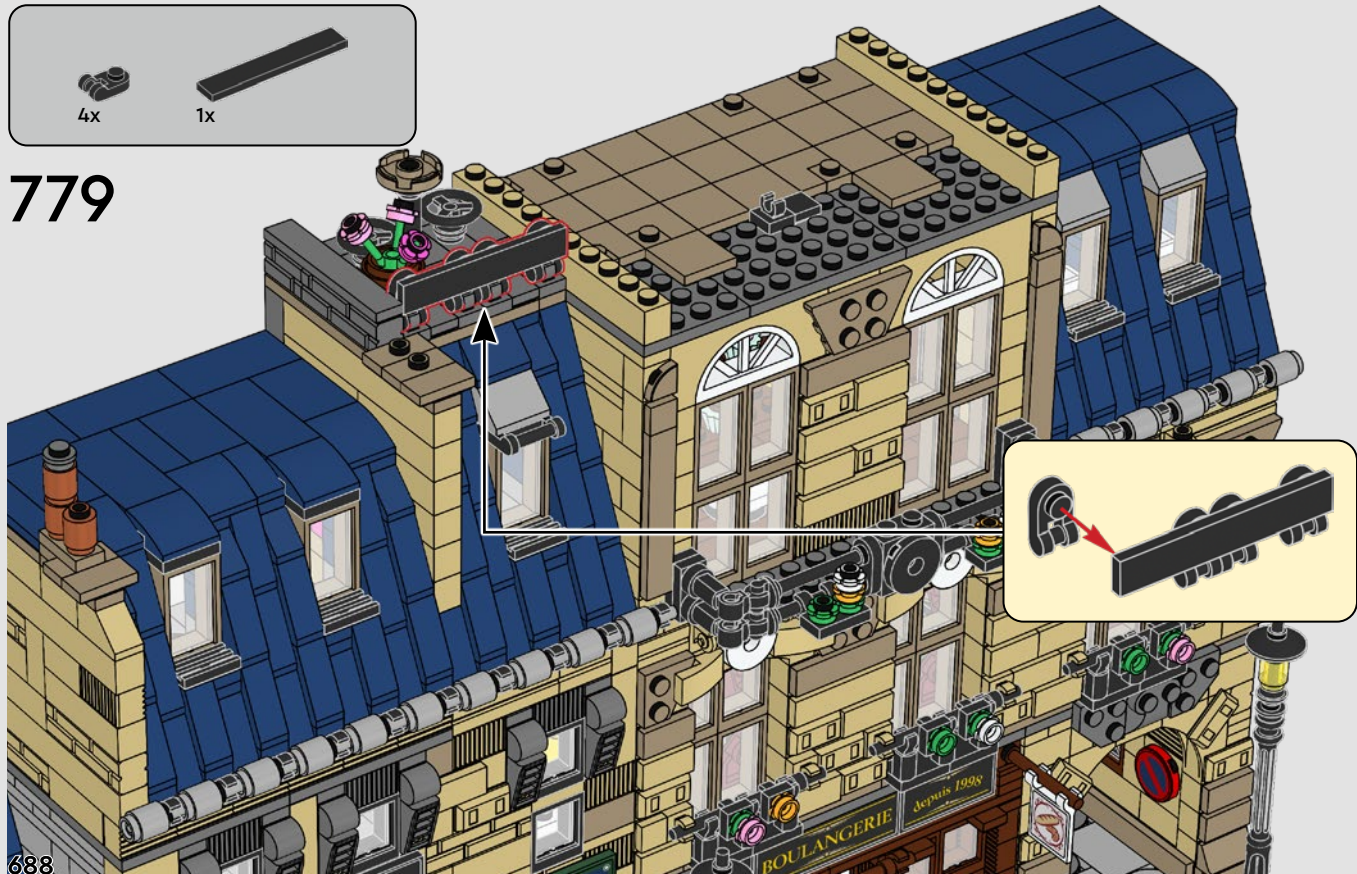



1x



2x

780





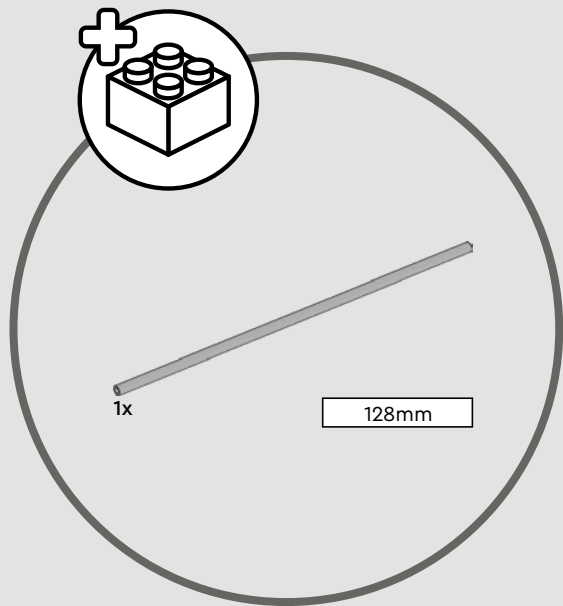

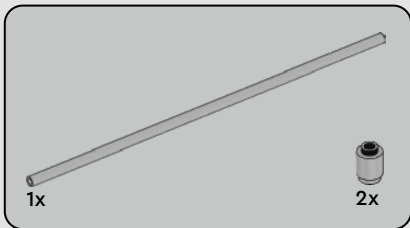
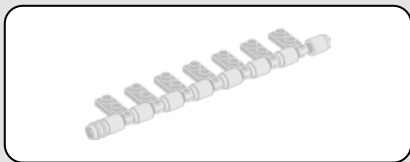

781

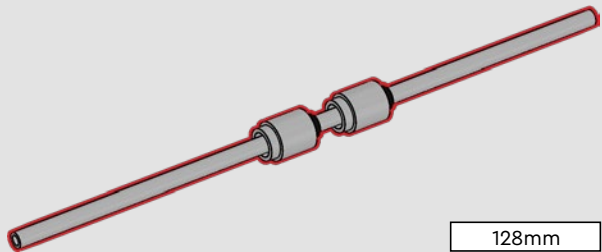

128mm

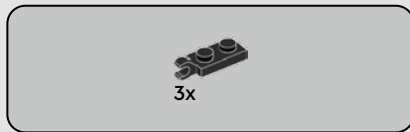

782

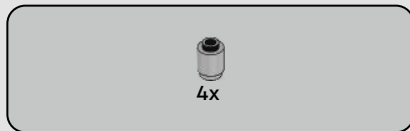
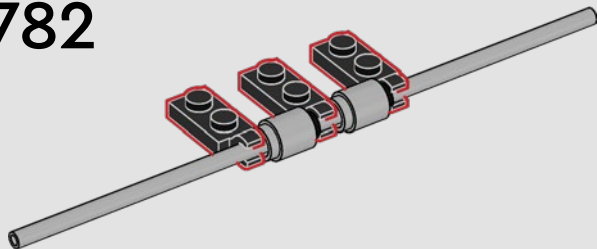

783

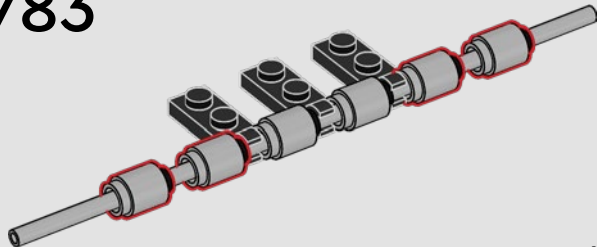



2x

# 784

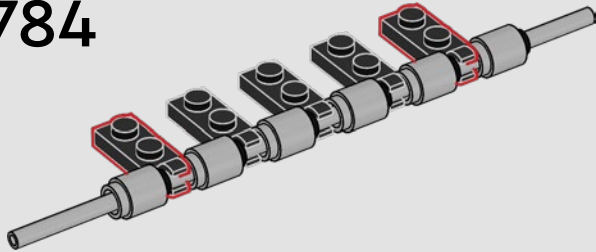

2x



2x

# 785

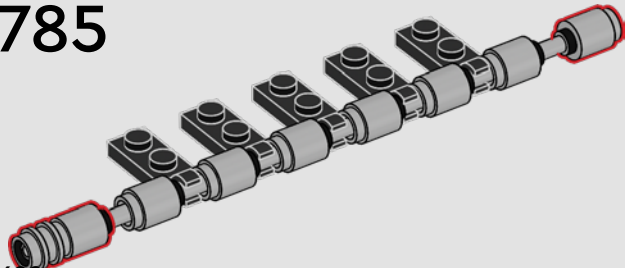

692



2x

# 786

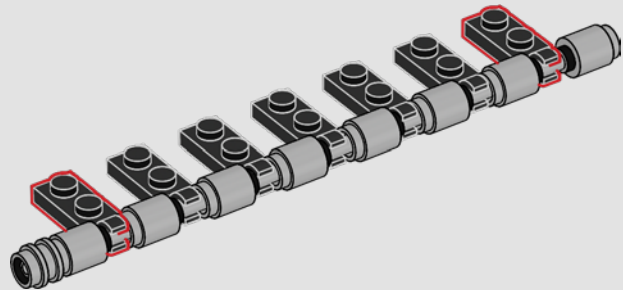

787

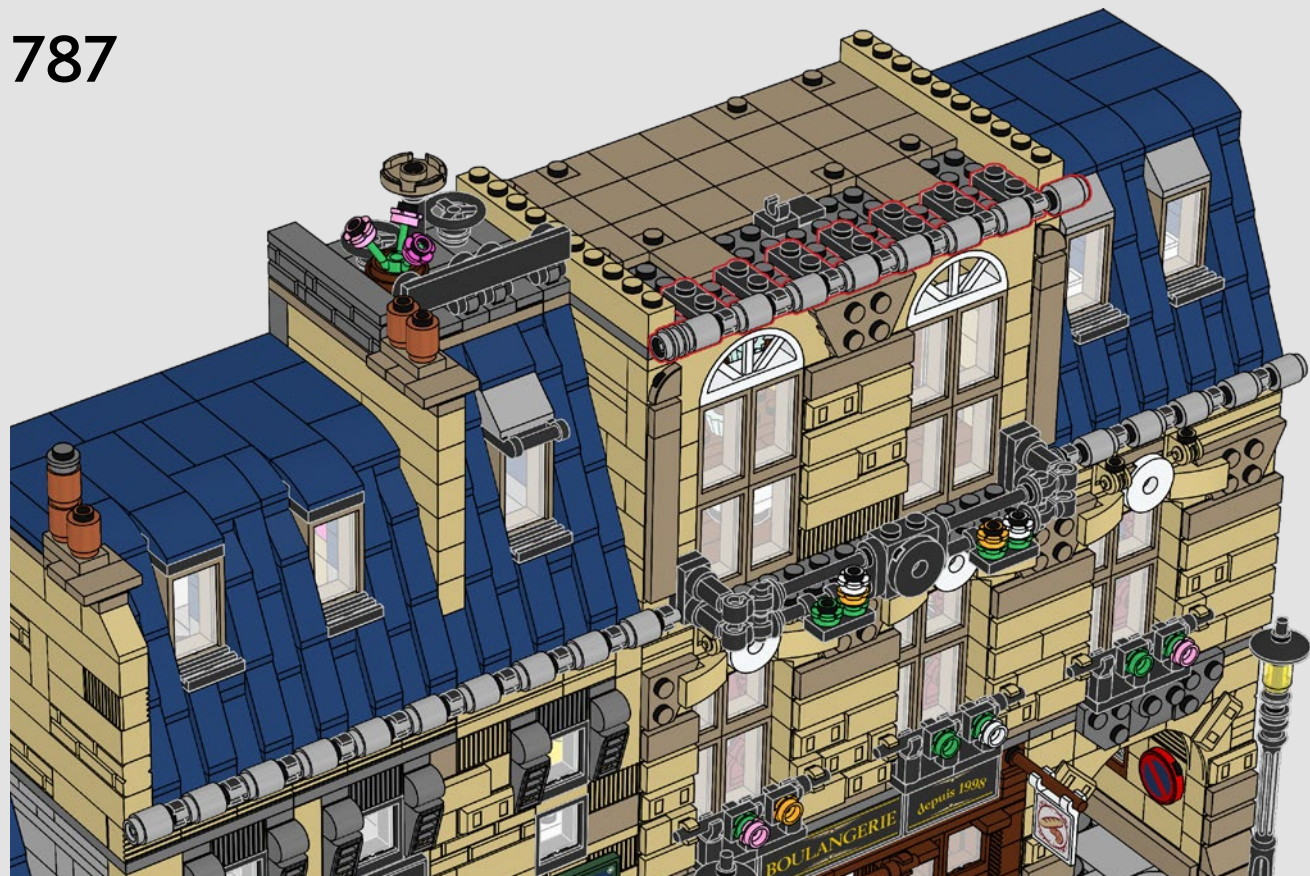

693





7x

788



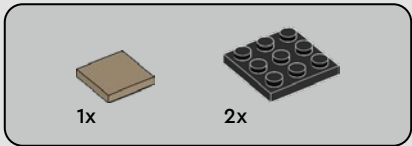
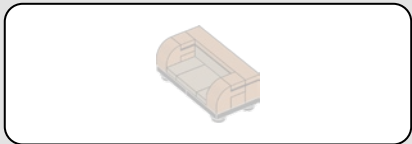

789

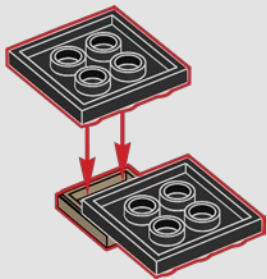

790

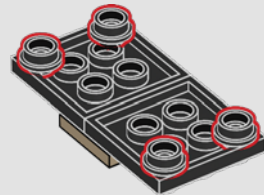

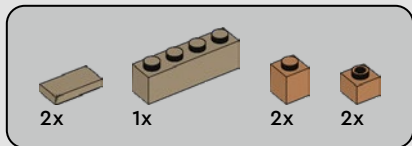

791

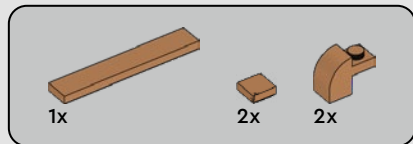
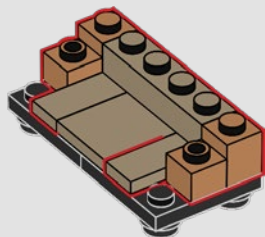

792

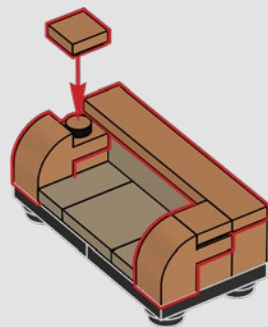

793

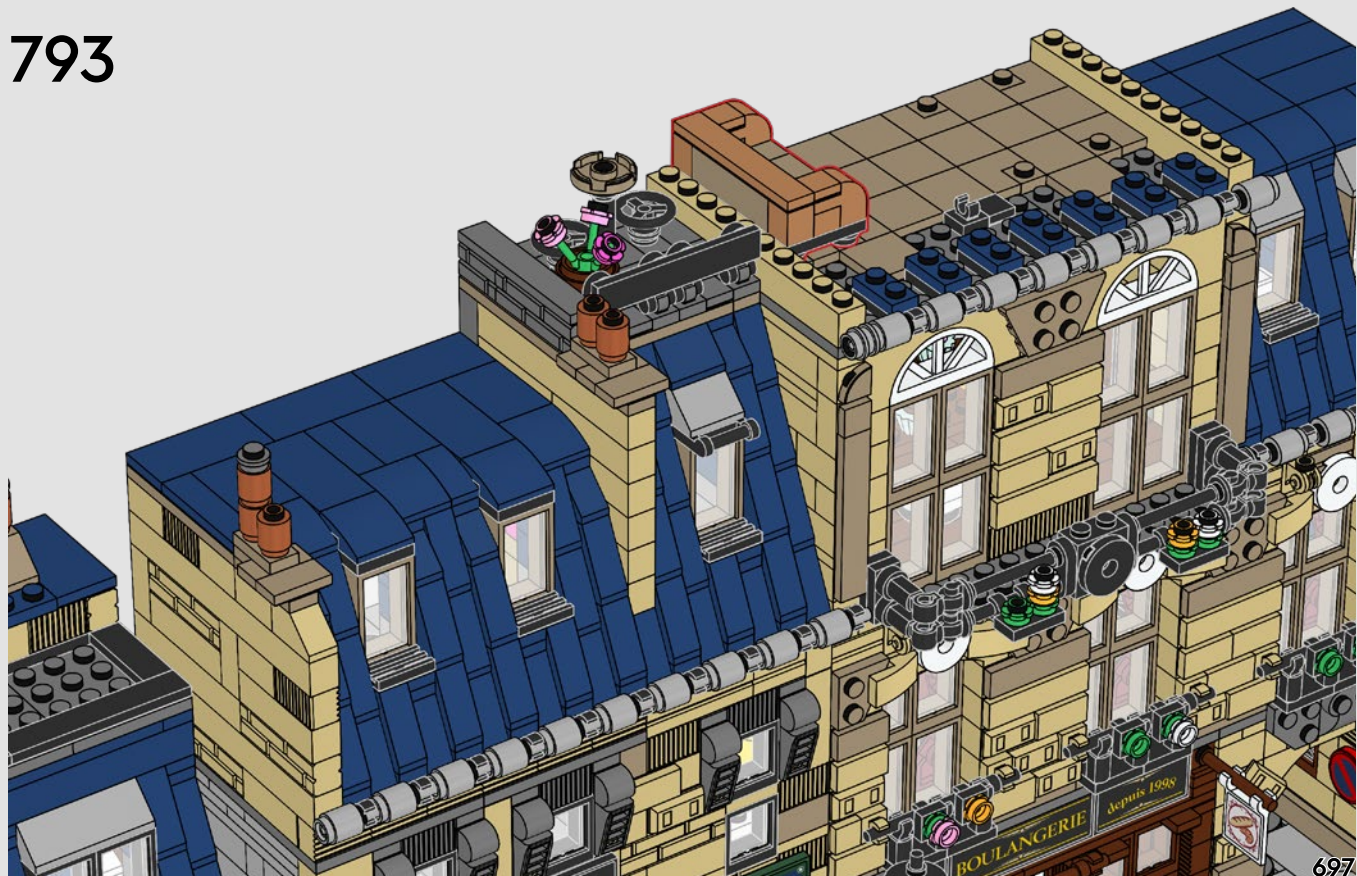





1x

794





2x

795





2x      2x      2x

796

1      2

2x

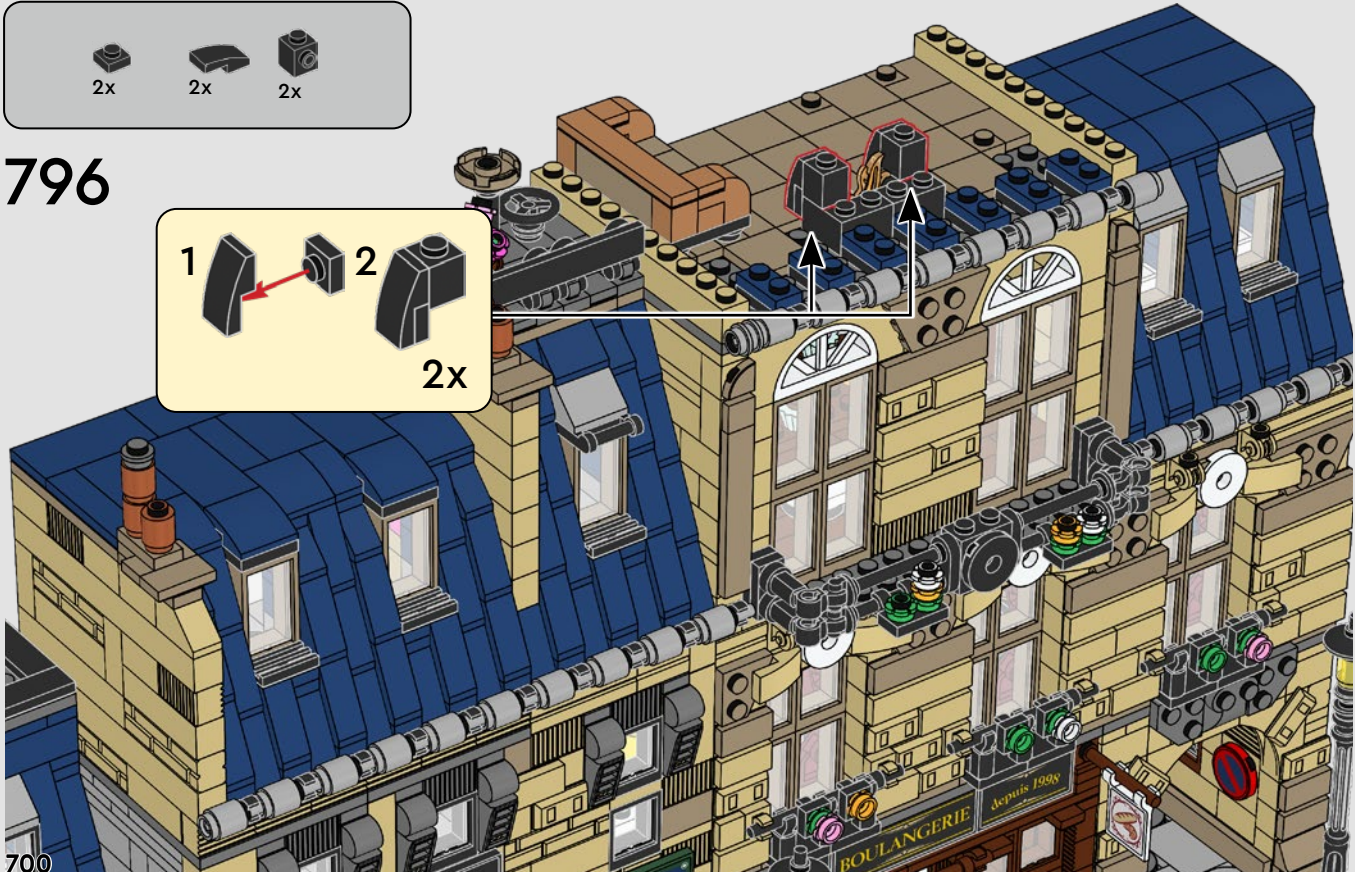

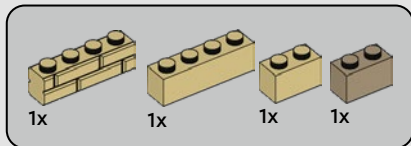

797

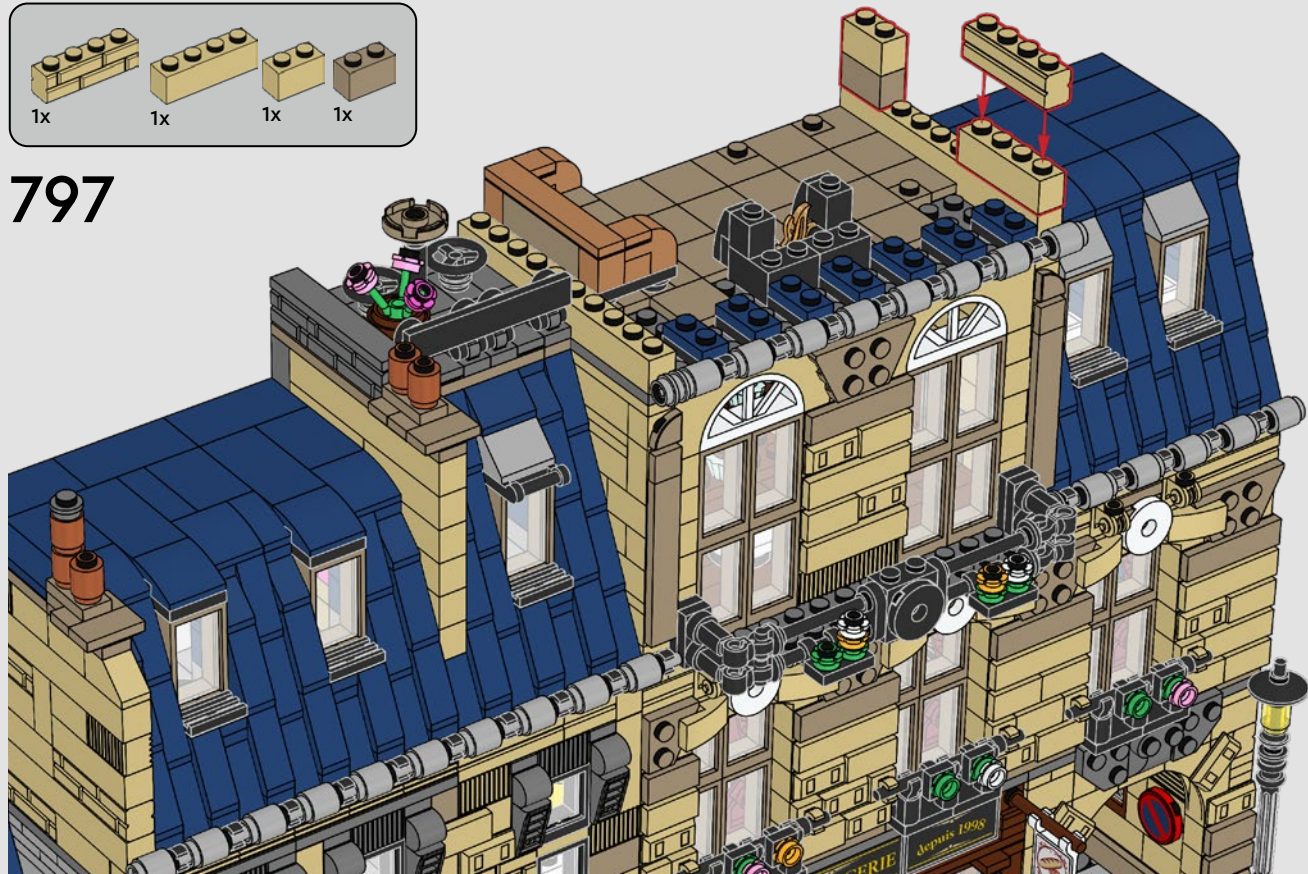



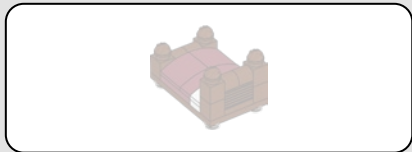

798

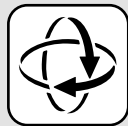
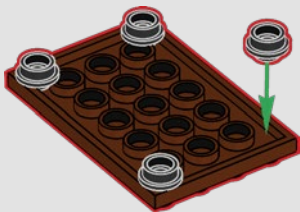

799





800

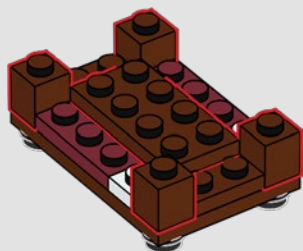

801

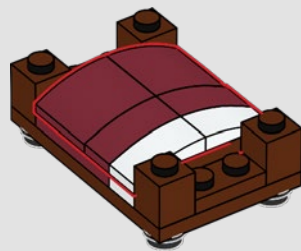



2x



1x

# 802

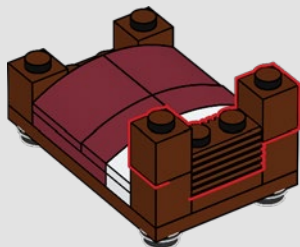

4x

# 803

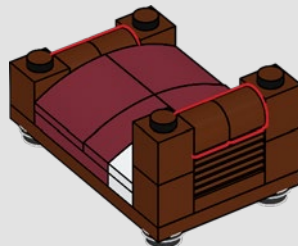

4x

# 804

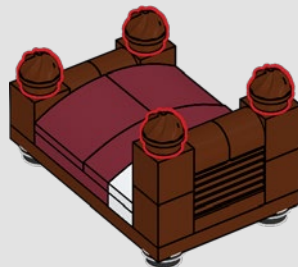

805

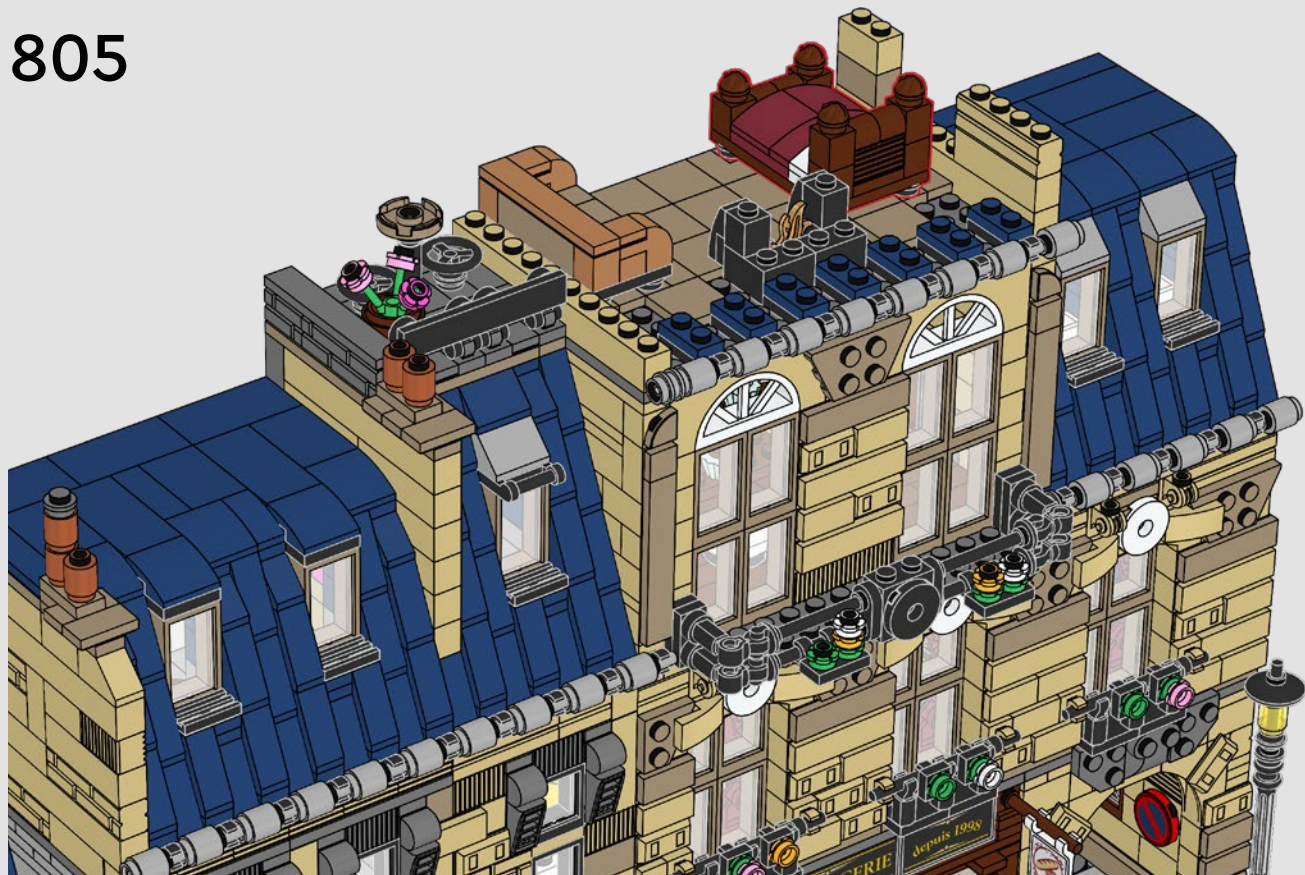

705



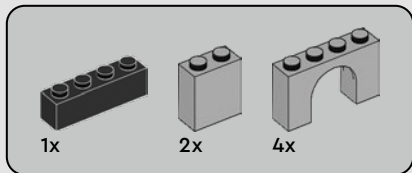

806

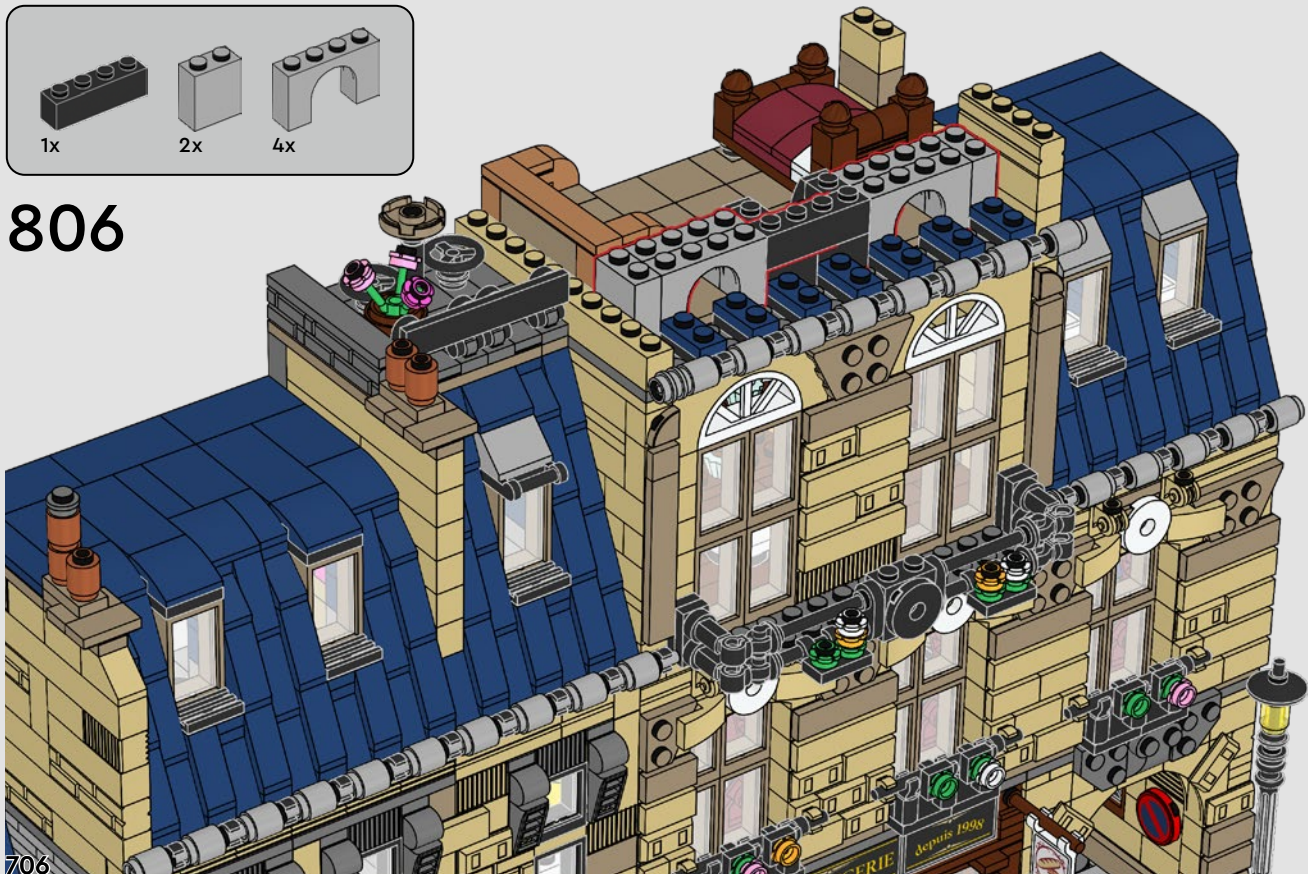

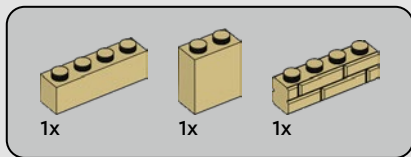

807







7x

# 808



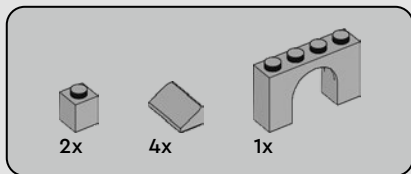

809

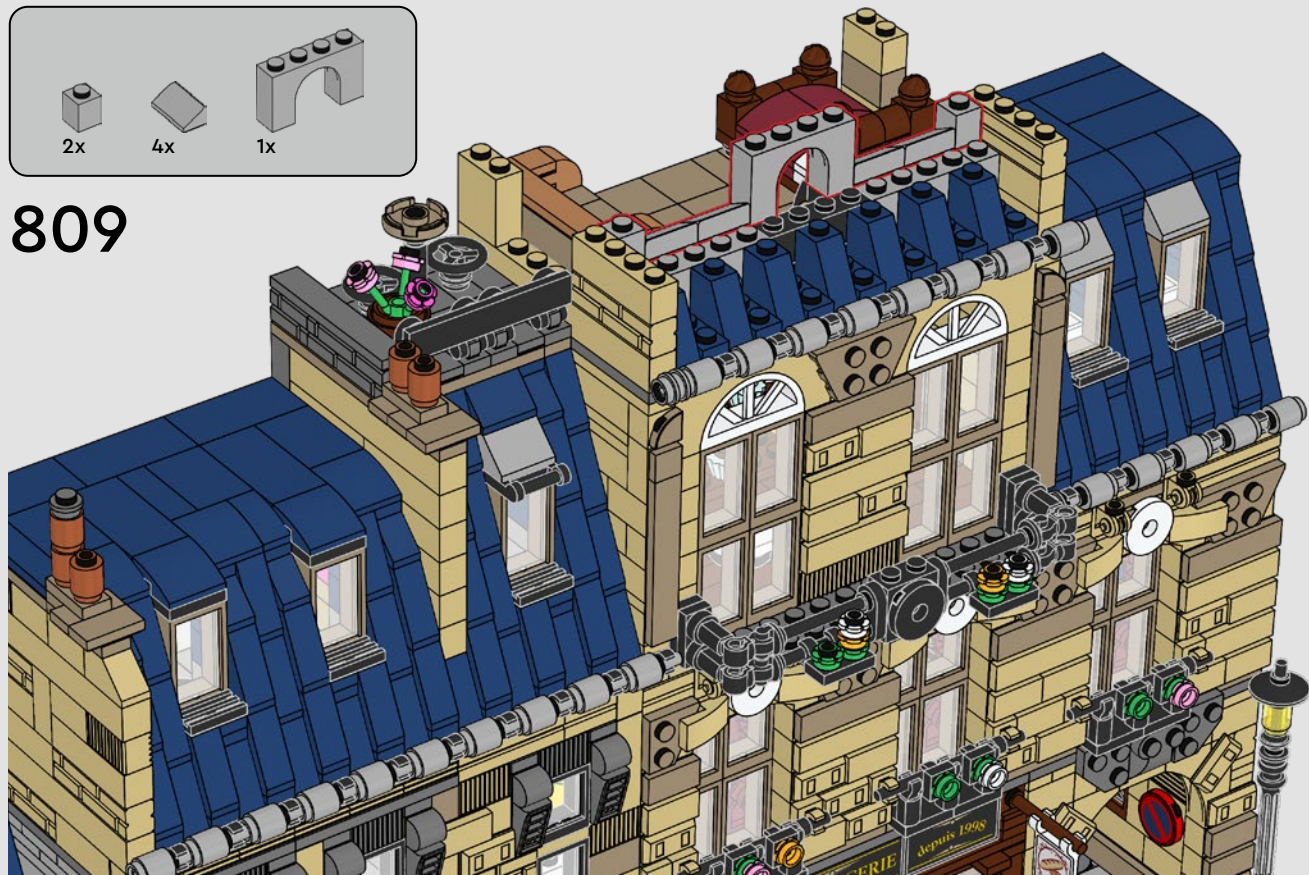





1x



2x



4x

# 810





7x

811







1x



2x



4x

# 812





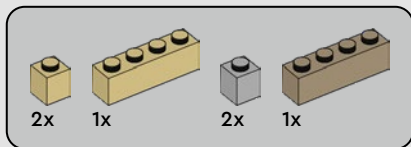

813



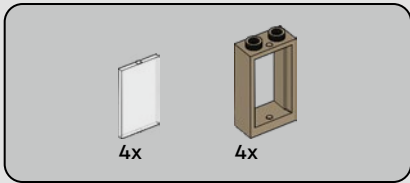

814

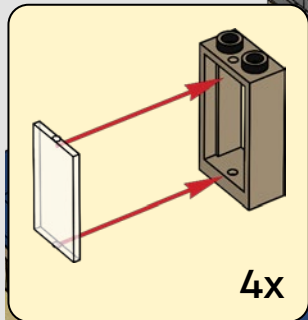





2x

815







6x

816



3x





4x

817



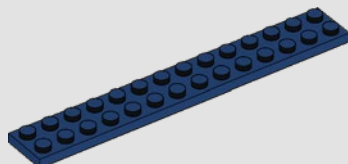
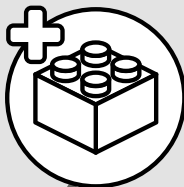

1x



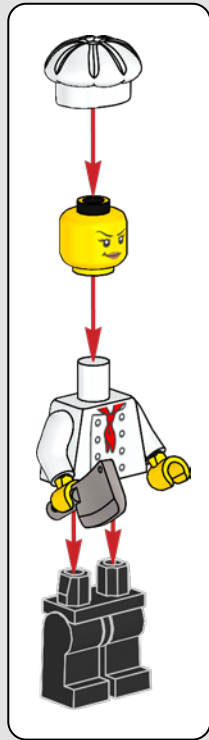
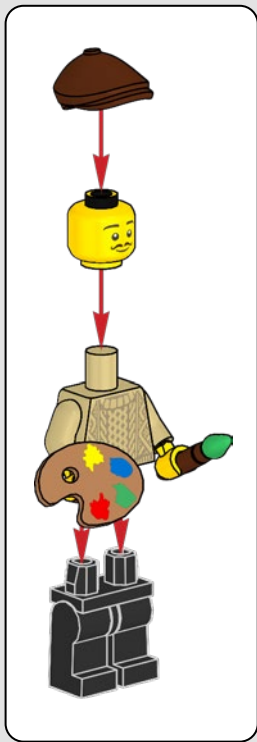

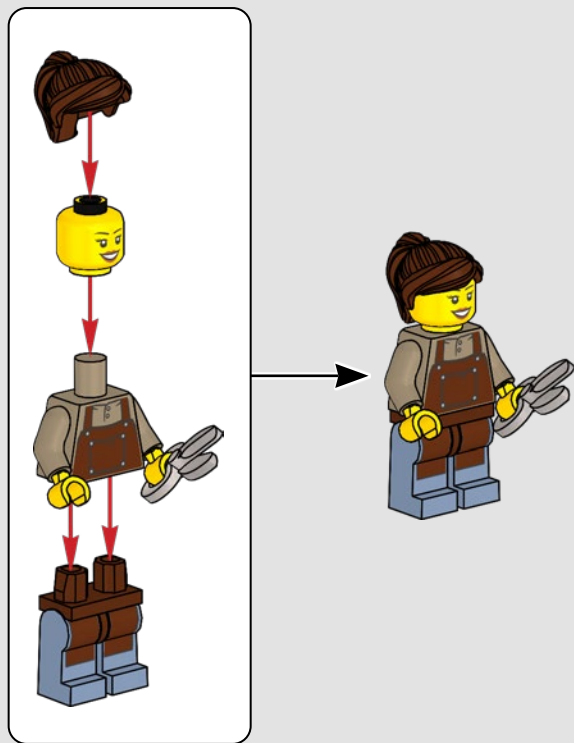

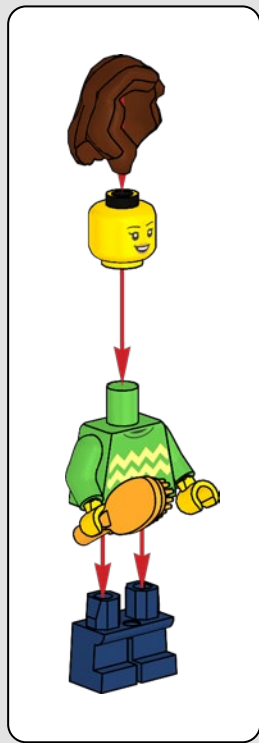
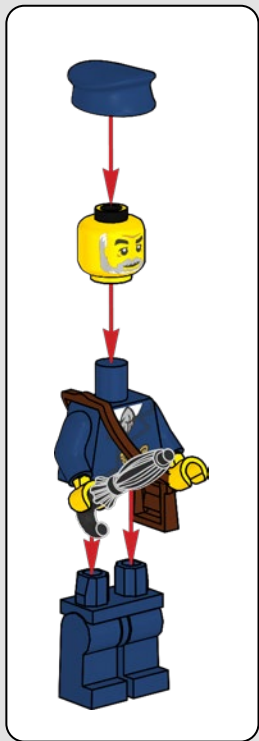



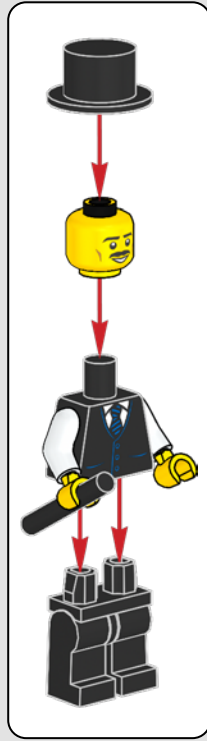
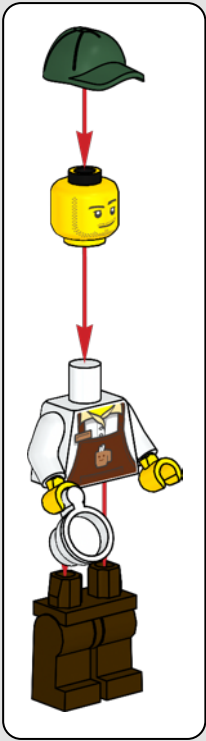

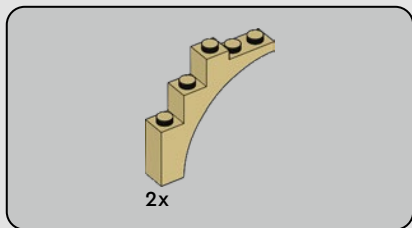

818



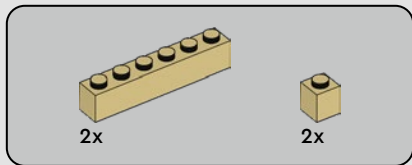

819





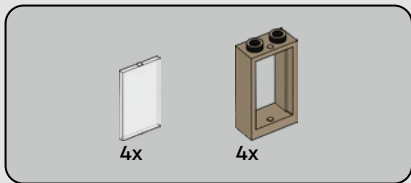

820

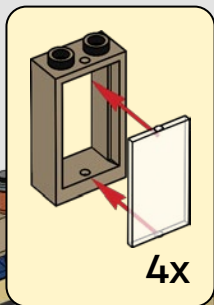



1x



1x



2x

# 821

1

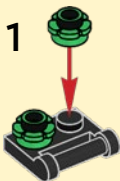

2





822





2x 2x 4x

# 823

1 2

2x



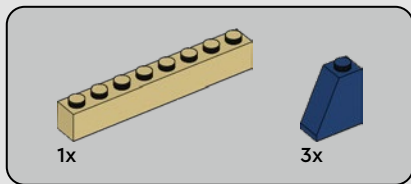

824





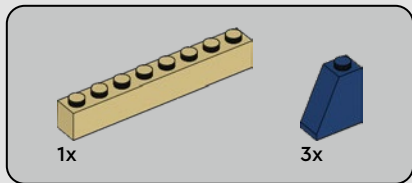

825







6x

826



3x



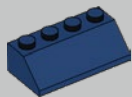

2x

827



732



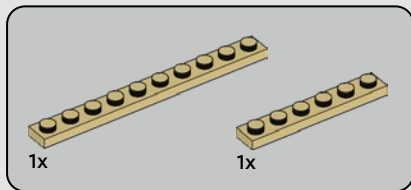

828

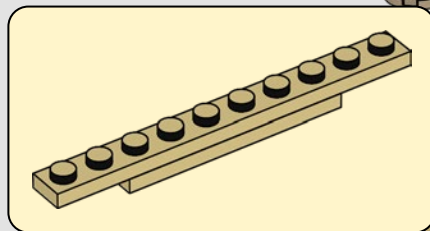



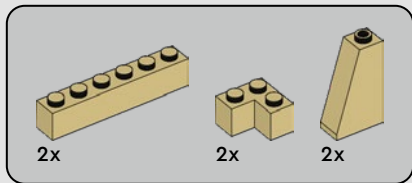

829

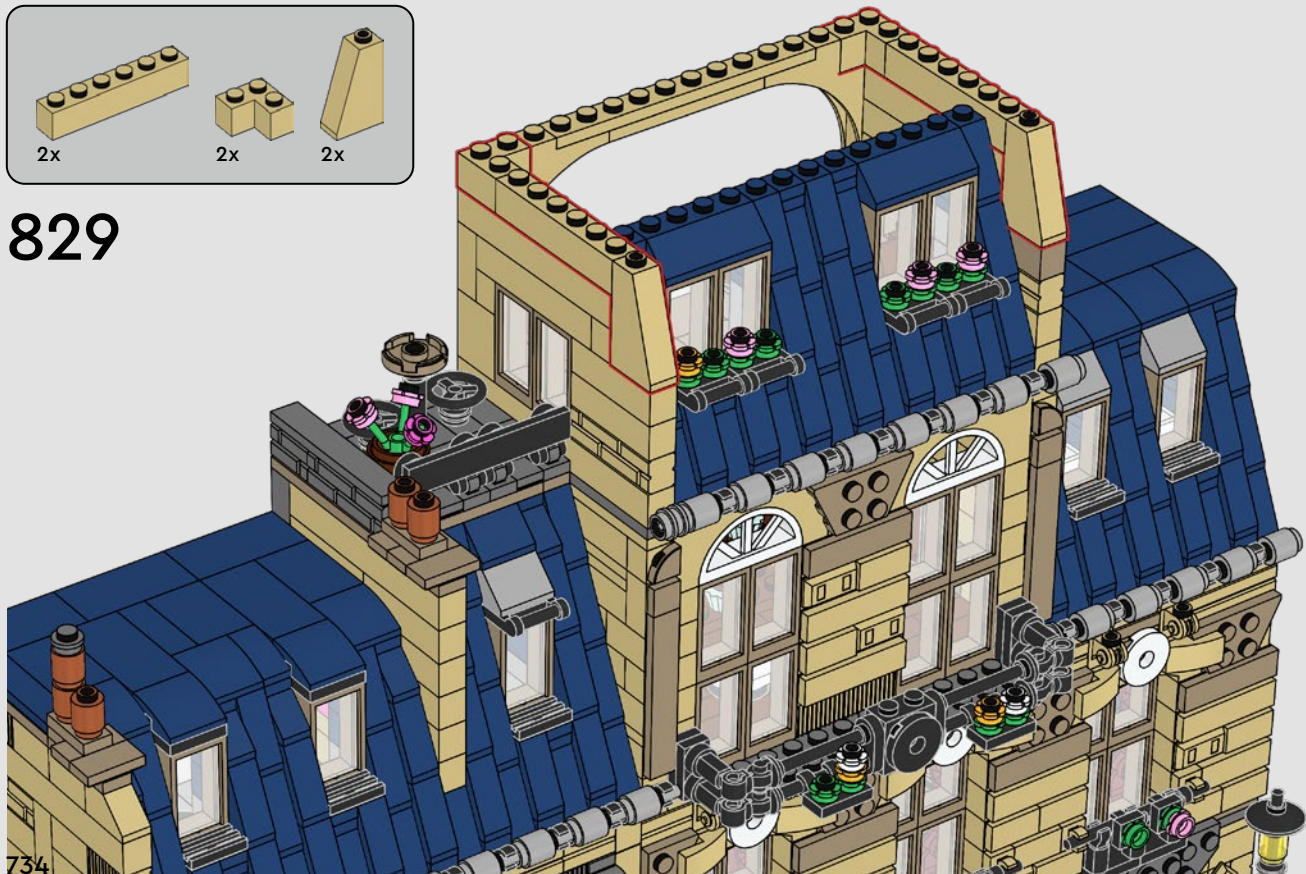

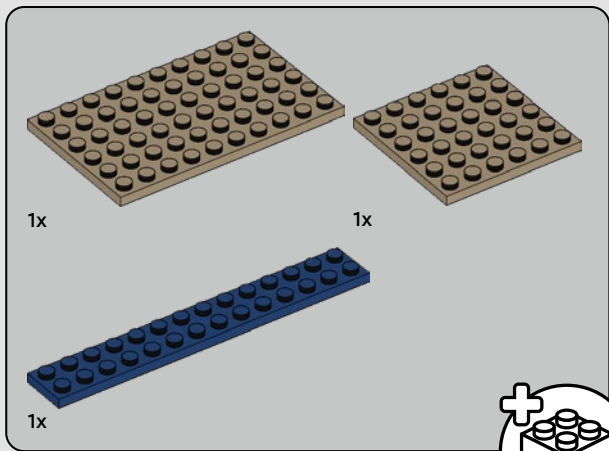
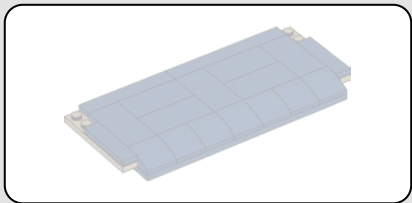

830

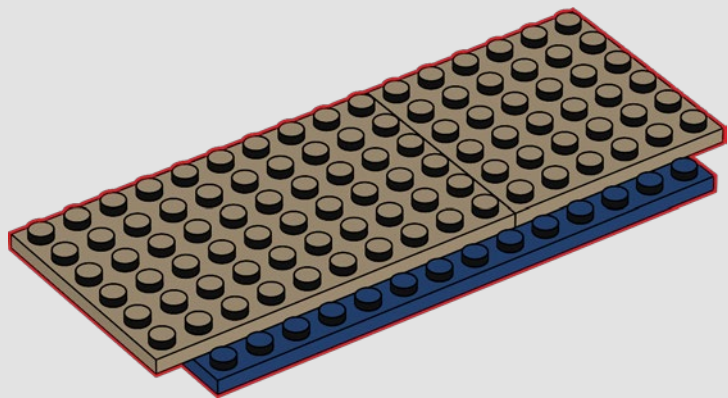



7x

831

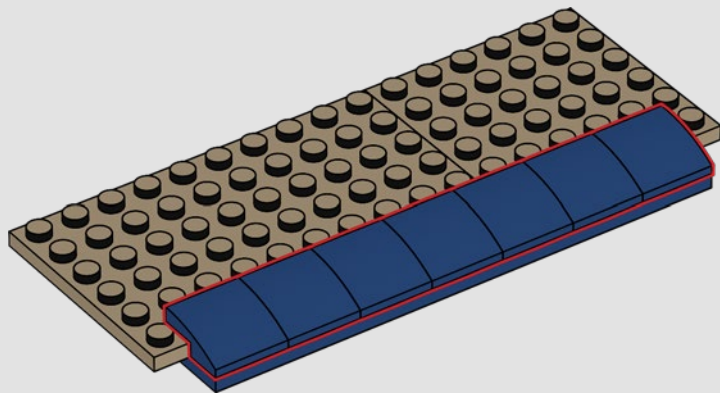



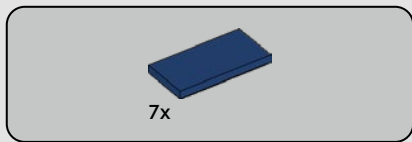

832

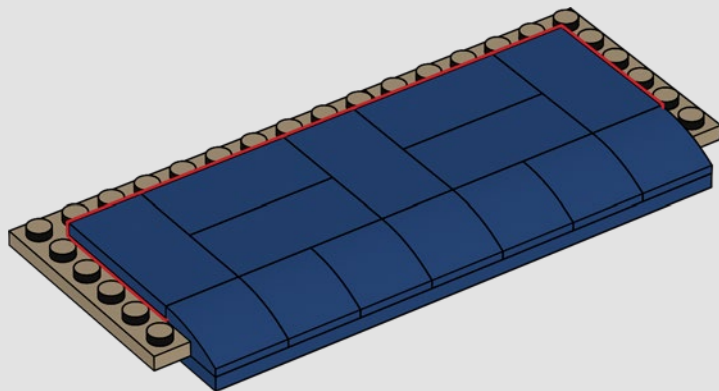

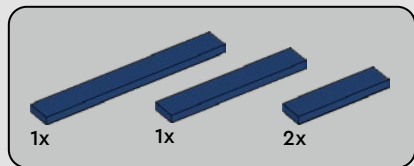

833

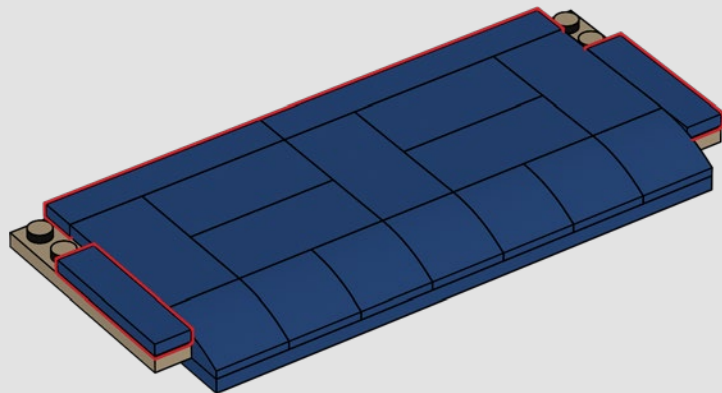

834







2x



2x



2x

# 835



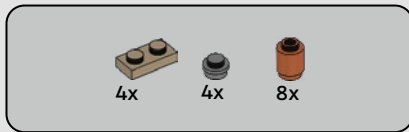



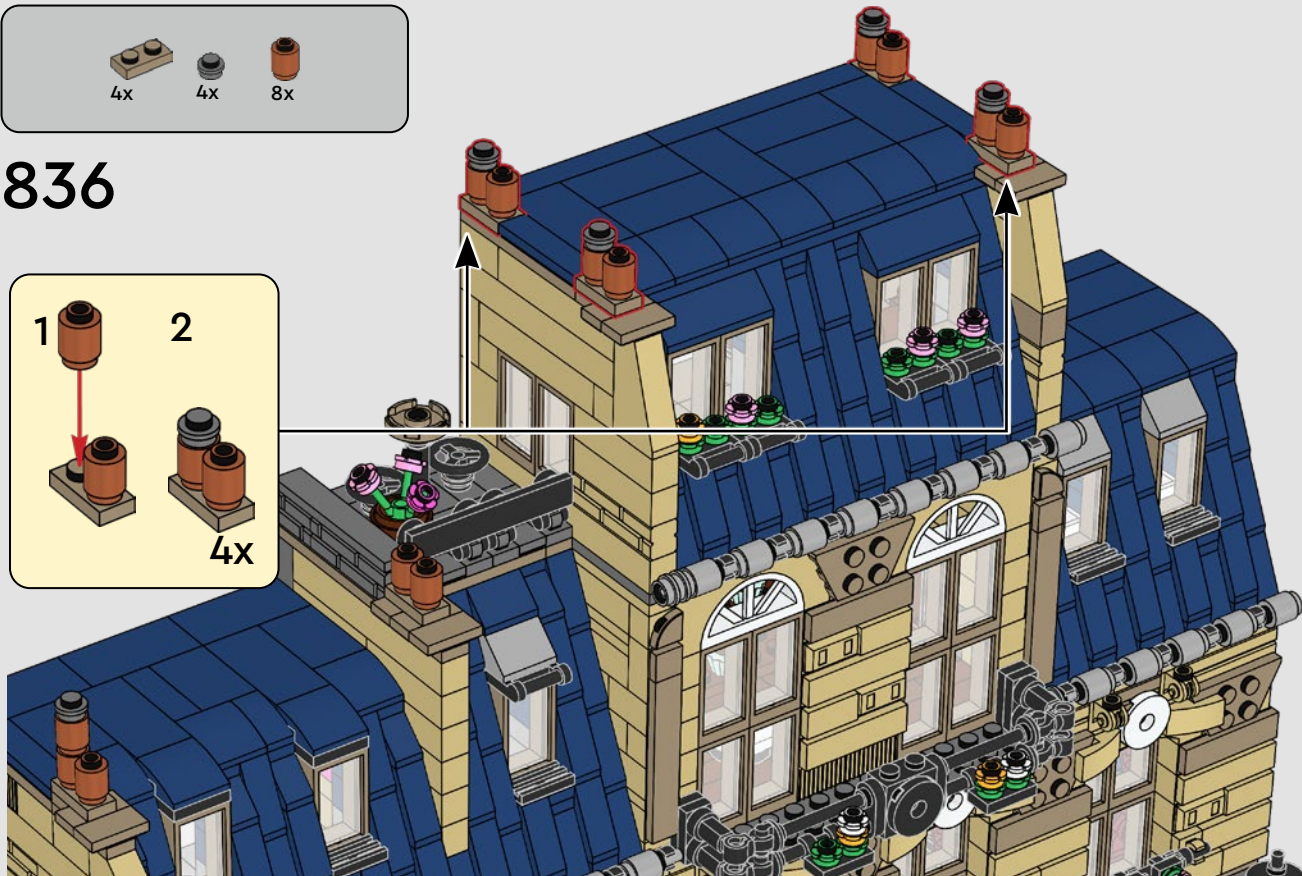
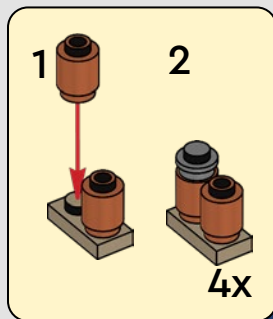







































































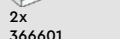







836







 1x 6234807	 1x 6050914	 2x 6365487	 1x 6219611	 1x 663601	 6x 6360078	 2x 4129996	 2x 4114064	 4x 6058093
 9x 6206149	 3x 434601	 11x 306801	 1x 6283797	 2x 4117070	 1x 4125253	 1x 4121972	 1x 6313611	 1x 6205345
 18x 6168642	 2x 474001	 2x 302201	 1x 4521943	 1x 4529237	 2x 6365720	 7x 6148262	 16x 4124455	 3x 6318084
 1x 4518400	 4x 6310185	 3x 6126046	 2x 6173064	 42x 4113915	 2x 6352222	 4x 6214334	 2x 4114306	 1x 4598467
 1x 6186681	 5x 306901	 1x 6172674	 2x 6173064	 18x 6232135	 6x 6114992	 18x 6024495	 4x 4114077	 2x 4582437
 1x 6186681	 4x 6248490	 4x 407901	 1x 4515347	 28x 4579260	 37x 4655900	 13x 6271228	 7x 4121921	 4x 4118790
 7x 302401	 6x 6034044	 3x 434501	 1x 6360131	 8x 6458392	 14x 4113917	 14x 4114026	 21x 4162465	 1x 4159739
 1x 6235083	 2x 302301	 1x 4179580	 2x 366601	 6x 6057517	 23x 4109995	 6x 6046922	 2x 6131896	 9x 4113233
 1x 6172366	 1x 6051511	 2x 6245249		 16x 4159553	 4x 4159279	 1x 6092587		
 1x 4659665	 2x 6097637							
 1x 6357680								
 1x 6452529								



20x  
4113916



26x  
6232136



23x  
4201062



1x  
4550323



5x  
4550324



2x  
6031057



1x  
6115031



2x  
4114319

744



7x  
6351905

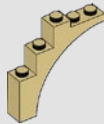

21x  
6075057



6x  
6106187



18x  
4112982



11x  
4124067



3x  
4618876



4x  
4113993

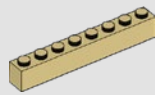

8x  
4159774



4x  
4114324

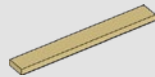

1x  
4544139



2x  
4113988



3x  
4143409

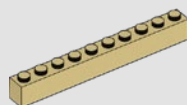

5x  
4166138

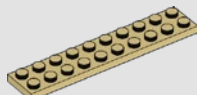

6x  
4249019

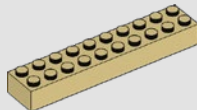

2x  
6294678



1x  
6156462

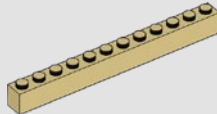

1x  
6075179

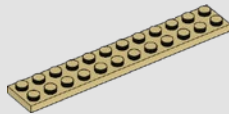

1x  
6093864

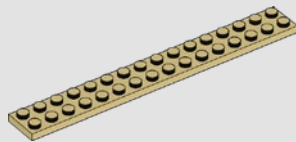

1x  
6030980



2x  
6328178



1x  
6330402



3x  
6206148



2x  
4529234



1x  
307021



1x  
389921



1x  
6066342



1x  
4529235



1x  
6382540



2x  
4525464



1x  
6211710



1x  
6270320



1x  
6218244



1x  
4651443



1x  
6384058



1x  
6174813























































































1x  
6224063



1x  
6210496



13x  
6290456

 9x 6315887	 2x 302426	 2x 6210270	 3x 9339	 7x 6275806	 25x 6336989	 1x 6013867	 3x 302126	 4x 6174917
 1x 6359833	 8x 6335388	 8x 6157554	 8x 287726	 4x 6184784	 16x 4225201	 2x 6211476	 2x 6162892	 3x 4560182
 5x 6056234	 6x 300526	 4x 6330189	 18x 241226	 4x 6020193	 4x 6350725	 2x 4567436	 1x 301026	 1x 6350415
 18x 6186675	 1x 4504382	 4x 403226	 20x 302326	 4x 6000650	 1x 6093525	 1x 4515368	 4x 4162443	 3x 6170421
 94x 6168646	 4x 6388352	 1x 6143850	 3x 6047276	 1x 6308883	 2x 235726	 2x 4558170	 7x 371026	 2x 366626
 3x 306226	 6x 6273589	 10x 6057397	 2x 306926	 2x 6132809	 13x 306826	 1x 6219624	 4x 6177083	 5x 663626
 5x 4529236	 2x 6187572	 1x 4105175	 10x 6382697	 2x 6132809	 5x 4565323	 1x 4227392	 4x 6177083	 5x 663626
 4x 6510216	 2x 6173105	 7x 474026	 26x 6468344	 8x 6310268	 10x 6192346	 7x 6116604	 6x 6337273	 2x 300926
 3x 6256435	 4x 6338384	 1x 6195325	 1x 6114987	 6x 6252201	 2x 302226	 5x 6394879		
 6x 4558954	 7x 6192778	 1x 452826			 6x 6053077			
 11x 307026								





1x  
6391342



1x  
6458165



1x  
379526



4x  
6318582



1x  
416226



2x  
346026

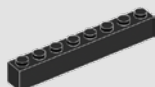

2x  
300826



3x  
303226



2x  
447726



37x  
6135287



9x  
6229130



8x  
6269971



1x  
6171069



3x  
4566179



1x  
6331100



1x  
6392114



18x  
6074890



2x  
6424035



2x  
6166107



8x  
6220959



21x  
6254552



59x  
6252258



3x  
6246888



3x  
6246888



1x  
6507876



1x  
6386637



3x  
6240225



6x  
6238674



9x  
6507875



1x  
6214234



1x  
4518029



1x  
6254100

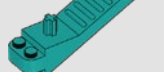

1x  
6254100



1x  
6209692



2x  
6188696



1x  
6003007



1x  
6395609



6x  
4620077



13x  
6177142



3x  
6398673



2x  
4620993



1x  
6371466



3x  
6322841



6x  
6055172



18x  
4549436



11x  
6362967



6x  
6001824



4x  
6040126



3x  
6310988



2x  
6245275



1x  
6385277



6x  
6015449



3x  
6132767



1x  
6135609



33x  
6468360



24x  
4496699



10x  
4521914



10x  
4528604



1x  
6310835



8x  
6092591



3x  
4646577



18x  
4507045



12x  
6398654



1x  
4550168



4x  
6126075



2x  
6093038



2x  
6047415



1x  
6184880



2x  
6132768



6x  
6015452



1x  
6335769



1x  
6368432



4x  
6003379



9x  
6328307



2x  
6035540



2x  
6001822



13x  
6175927



2x  
4267874



6x  
6164288



5x  
4507047



5x  
4247151



2x  
6015424



1x  
6166127



4x  
6156492



4x  
4246957

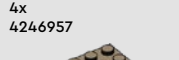

4x  
4530712



2x  
6322219



1x  
6096215



2x  
4177741



19x  
4255413



63x  
4184108



7x  
6253883



1x  
4631385



1x  
6399256



1x  
6253885



1x  
4530129



1x  
4162916



102x  
6097429



34x  
4528981



26x  
4249891



6x  
6103405



2x  
6382723



4x  
6135606



4x  
4528488



2x  
6164071



5x  
6094143



3x  
6363600



18x  
4528482



21x  
6061569



1x  
4153653



3x  
4205004



9x  
6132566



3x  
6233955



4x  
4177735



1x  
6409766



1x  
6186576



1x  
6251836



6x  
6186974



4x  
6103985



2x  
4264569



2x  
4502089



2x  
4578094



19x  
4569836



1x  
6275133



1x  
4667595



5x  
4252437



3x  
6221672



4x  
4508313



1x  
6097420



1x  
4507080

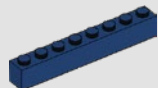

1x  
6277303



1x  
6186638



1x  
6411591



5x  
6055171



4x  
4521915



8x  
6055169



1x  
6217106



1x  
6013102



8x  
6411352



1x  
6326011



4x  
6426639



1x  
6314882



2x  
4650244



1x  
4543949



2x  
6253285



2x  
6440430



8x  
4539099



4x  
6322997



6x  
4541376



2x  
6212007



4x  
6311108



2x  
6311890



4x  
4539114



3x  
6008593



3x  
6008595



10x  
6083977



6x  
6173168



12x  
4539090



8x  
4539097



6x  
6252545



6x  
4541506



2x  
6212084



1x  
6092597



6x  
6210310



3x  
4539102



2x  
6107758



8x  
6369265



21x  
4539105



2x  
4585479



1x  
6172632



2x  
4539076



1x  
6264025



1x  
6062650



1x  
6052777



1x  
4539070



8x  
6186003



2x  
4539062



1x  
4650865



2x  
6152321



7x  
6357747



2x  
6314353



14x  
6209681



1x  
4243668



1x  
4286789



1x  
6096091



2x  
4243920



1x  
6359662



13x  
6060731



7x  
4211183



1x  
6314960  
4x  
6328180  
2x  
4626196  
33x  
4211242  
12x  
6371437  
2x  
4211180  
12x  
4211288  
16x  
4225469  
27x  
4221744  
1x  
6093515  
1x  
4550736  
1x  
6408343

1x  
4211157  
4x  
6365627  
1x  
6278989  
2x  
4211180  
1x  
6120224  
19x  
4223303  
9x  
6397820  
21x  
6092590

9x  
6382102  
5x  
4211149  
2x  
4211222  
20x  
4211150  
2x  
4542131  
14x  
4211151  
1x  
6172808  
4x  
6064188

1x  
6270078  
4x  
6174856  
10x  
4645103  
2x  
6338135  
4x  
4565394  
6x  
6425510  
3x  
4211257  
5x  
4211200  
2x  
6196221

2x  
4216695  
4x  
6470170  
5x  
4211152  
4x  
6251470  
10x  
6100769  
1x  
4211220  
2x  
6055086  
1x  
6248918

2x  
6116613  
1x  
4211189  
1x  
4211225  
1x  
4211190  
18x  
4211194  
1x  
6262952  
4x  
4211186  
1x  
6307618

2x  
6044725  
2x  
6170468  
26x  
4211204  
4x  
4221590  
2x  
4211193  
5x  
4211247  
1x  
4263776



6x  
4585337



3x  
4271874



2x  
4223683



1x  
4211207

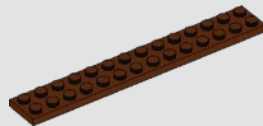

1x  
6004996

23x  
4211412

5x  
6168647

750

9x  
6284071

1x  
4529241

3x  
6250597

31x  
4211389

17x  
4211415

1x  
6061702

20x  
4211399

7x  
6401023

10x  
6176433

8x  
6308012

1x  
4211476

8x  
4558953

6x  
6225242

4x  
6345426

6x  
4568637

1x  
4650645

16x  
6052200

3x  
4657459

25x  
4211383

5x  
4211564

4x  
6000066

8x  
4211398

3x  
6015344

32x  
4211414

6x  
6066097

5x  
4593679

13x  
4211388

1x  
4211437

2x  
6170387

1x  
6326078

2x  
4654582

3x  
4211410

5x  
4211387

4x  
4211349

4x  
6435857

19x  
6065824

30x  
4211413

5x  
6126082

3x  
4211397

2x  
6212077

3x  
4211881

8x  
4211428

8x  
4211429

8x  
4558169

1x  
4211396

5x  
6171894

1x  
4211386

13x  
6031056

15x  
4211445

2x  
4211435

4x  
4211394

1x  
4211356

2x  
6314891

2x  
4211636

2x  
6257593

4x  
6385740

2x  
4211385

2x  
4211395

5x  
4560183

2x  
4211409

4x  
6075066

2x  
4211549

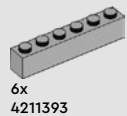

6x  
4211393



3x  
4211438



5x  
4618874

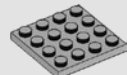

1x  
4243797

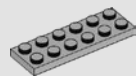

1x  
4211452



1x  
4211795



6x  
4211425

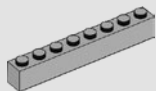

2x  
4211392



2x  
6313653



5x  
4211406

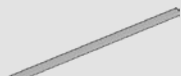

1x  
6361430



1x  
4211521

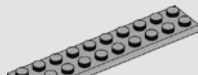

4x  
4211462



1x  
4211360

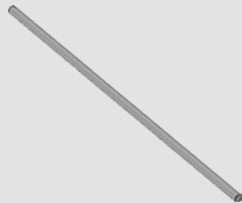

1x  
6191556

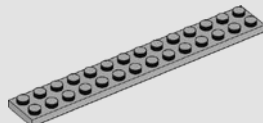

3x  
4662161

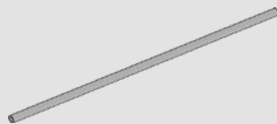

1x  
6409852



7x  
4210633



4x  
6284596



3x  
6362252



11x  
4211098



3x  
6388133



13x  
4210719



2x  
4210848



4x  
6344022



6x  
6333129



9x  
6199549



1x  
6396489



1x  
6388119



11x  
6056296



3x  
4210636



4x  
4211088



2x  
6230233



1x  
4210978



16x  
4211052



2x  
6092572



6x  
4540386



3x  
4211066



4x  
4211063



2x  
6164073



1x  
6000311



2x  
6146321



1x  
4211060



2x  
6126083



2x  
4210635



2x  
4218696



5x  
4211104



2x  
4211133



1x  
4568734



1x  
4211105



1x  
6187008



2x  
4211103



1x  
6055310



1x  
4210725



1x  
4560184



6x  
6075060





3x  
4211100



1x  
4211056

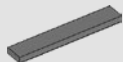

6x  
4210651



2x  
6106191



2x  
4210875



1x  
4211002



2x  
6262023  
**752**

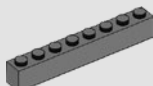

2x  
4211099



3x  
4210998

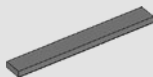

7x  
4211008



1x  
6313652



2x  
4211115



2x  
4211134



1x  
4500517



3x  
4257526



1x  
4210678



1x  
4210794



4x  
4211122



13x  
4211114

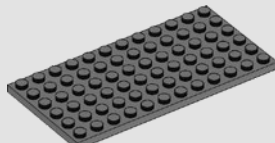

4x  
4256149

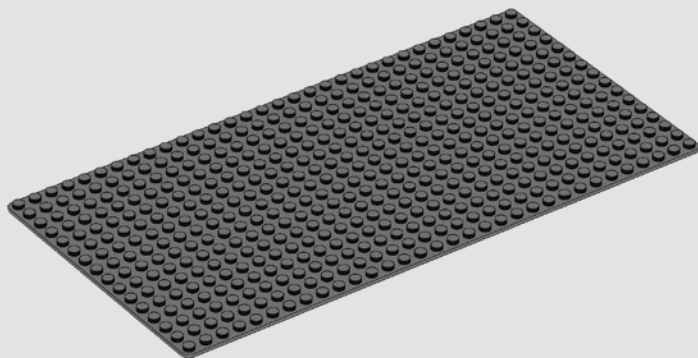



2x  
4269651





2x  
6209683

 6x  
6209679

 1x  
6133726

 18x  
6212501

 4x  
6424008

 1x  
6381793

 1x  
6278447

 6x  
6060800

 1x  
4529247

 2x  
6326425

 2x  
6403998

 1x  
4529672

 1x  
4566688

 2x  
6167928

 3x  
6313874

 2x  
6295366

 3x  
4518687

 2x  
6057986

 2x  
6177146

 2x  
6383946

 1x  
6345494

 2x  
6360296

 1x  
6102995

 2x  
6363149

 2x  
6096993

 1x  
6404754

 1x  
6249118

 5x  
6361352