



18+

910033

Old Train Engine Shed

Designed by Maria Kalaoglou



910033

Old Train Engine Shed

Designed by
Maria Kalaoglou

"All black, well stacked, goin' down the track clickity clack."

Your support and investment in me keep my creative engine chugging, and I can't thank you enough for being the steam force behind the Old Train Engine Shed LEGO® set. Choo-choo awesome of you!



Alter Lokschuppen

„Tschu, tschu, tschu, die Eisenbahn.“

Eure Unterstützung und eure Investition in mich haben mir Feuer unter dem Kessel gemacht. Mit diesem Dampf habt ihr meine Kreativität entfacht. Ich kann euch gar nicht genug dafür danken, dass ihr mich zu diesem LEGO® Set motiviert habt.

Viel Freude am Alten Lokschuppen und tschu, tschu ...

Entworfen von Maria Kalaoglou

Ancien entrepôt à locomotives

Conçu par Maria Kalaoglou

« Le train entre en gare. »

Mon moteur créatif doit tout à votre soutien et à votre investissement. Je ne vous remercierai jamais assez d'avoir été la force motrice à l'origine de L'ancien entrepôt à locomotives LEGO®.

Tchou-tchou !

Vecchio deposito di locomotive

Ideato da Maria Kalaoglou

"Il treno va, scomparirà sulle sue ruote rotonde, dietro le nuvole bionde".

Il vostro supporto e la vostra fiducia in me mantengono acceso il mio motore creativo e non potrò mai ringraziarvi abbastanza per essere stati la forza trainante dietro al mio set Vecchio deposito di locomotive LEGO®.

Un ciuf ciuf a tutti voi, fantastici amici!

Antigua Estación

Diseñado por Maria Kalaoglou

¡Negro como el carbón, bien aprovisionado, surcando las vías sin descanso!

Vuestro apoyo e inversión en mí hacen que mi locomotora creativa siga funcionando, y nunca podré agradecerlos lo suficiente que seáis la máquina de vapor del set LEGO® Antigua Estación.

¡Que suene el silbato en vuestro honor!

Oficina Antiga de Comboios

Criado por Maria Kalaoglou

«No comboio descendente Vinha tudo à gargalhada, Uns por verem rir os outros E os outros sem ser por nada.»

O vosso apoio e investimento mantém o meu comboio criativo na linha. Não tenho palavras para agradecer toda a vossa força a vapor por detrás do set LEGO® Oficina Antiga de Comboios.

Pouca terra, pouca terra – muito obrigada!

老火车维修站

由 Maria Kalaoglou 设计

“整体黑色，设计精巧，可以沿着轨道咔哒咔哒地行驶下去。”

你对我的支持和投资可以让我的创意引擎不断运转下去，非常感谢你能成为乐高®套装老火车维修站背后的蒸汽动力。

呜呜，你太棒了！

Stara lokomotywownia

Autorka: Maria Kalaoglou

„Stoi na stacji lokomotywa, Ciężka, ogromna i pot z niej sływa“.

Wasze wsparcie i zainteresowanie są paliwem mojej kreatywności. Ogromnie dziękuję za to, że byliście siłą napędową, która pozwoliła mi stworzyć zestaw LEGO® Stara lokomotywownia.

Jesteście niesamowici!



bricklink
designer
program

SERIES 1



910033

Old Train Engine Shed

Designed by
Maria Kalaoglou

"All black, well stacked, goin' down the track
clickity clack."

Your support and investment in me keep my
creative engine chugging, and I can't thank
you enough for being the steam force behind
the Old Train Engine Shed LEGO® set.

Choo-choo awesome of you!



Staré vlakové depo

„Cely černý, správně seřazený, rachotí si po trati.“

Vaše podpora a investice udržují moji tvorivost v chodu. Velice vám děkuji za to, že jste
hnači silou, která dala vzniknout stavebnici LEGO® Staré vlakové depo.

Š-š-š-š-húú – jste báječní!

Autorka návrhu: Maria Kalaoglou

Staré vlakové depo

„Ide vláčik ši-ši-ši, odvezie nás k Mariši.“

Vaša podpora a investície podporujú chod môjho kreatívneho motora a najviac na svete
vám ďakujem, že ste parnou silou, ktorá stojí za stavebnicou LEGO® Staré vlakové depo.
Ide, ide vláčik, ide, ide vlak, a ja sa chcem všetkým poďakovať!

Navrhlá Maria Kalaoglou

Régi vasúti szerelőcsarnok

Ez a gőzös minden ellenőrzésen átzakato!

A támogatásotok és a belém fektetett energiátok tartja mozgásban a kreatív
fogaskerekeimet, és nem tudom eléggé megköszönni, hogy gőzerővel segítettetek a
Régi vasúti szerelőcsarnok LEGO® készlet megtervezésében!

Si-hu-hu, nagyszerűek vagytok!

Tervezte: Maria Kalaoglou

Vechea remiză pentru locomotive

„Tot aranjat, bine echipat și gata să gonească pe șine, clic-clac.“

Suștinerea și investiția ta în mine îmi mențin în funcțiune motorul creativ și sunt foarte
recunoscătoare că ești forța care face posibil setul LEGO® Vechea remiză pentru locomotive.
Super grozav din partea ta!

Conceptul de Maria Kalaoglou

Vecais vilcienu depo

„Čuku, čuku, čuku tūūu, ripo vilcieniņš.“

Tavs atbalsts un ieguldījums uztur manu radošo garu, un es esmu ļoti pateicīga par to,
ka tu esi mans dzinējspēks Vecā vilcienu depo LEGO® komplekta.

No sirds pateicos!

Autore Marija Kalaoglou

Vana rongimootori kuur

„Kõik mustad, kaupa täis, sõidavad kilinal-kolinal mööda rööpaid.“

Sinu toetus ja investering minusse hoiavad mu loomingulise mootori töös ja ma ei jõua
sind piisavalt ära tänada, et oled aurujõud Vana rongimootori kuuri LEGO® komplekti taga.

Tšuu-tšuu, kui äge sinust!

Kujundanud Maria Kalaoglou

Senasis garvežių depas

„Pajuodavęs, pilnutėlis, rieda bėgiais paskui vėją.“

Jūsų palaikymas ir investicija į mane palaiko mano kūrybinį variklį, todėl negaliu jums
atsidėkoti už tai, kad esate Senojo garvežio depo LEGO® rinkinio varomoji jėga.

Čiū čiū, tarius jums ačiū!

Sukūrė Maria Kalaoglou



bricklink
designer
program

SERIES 1

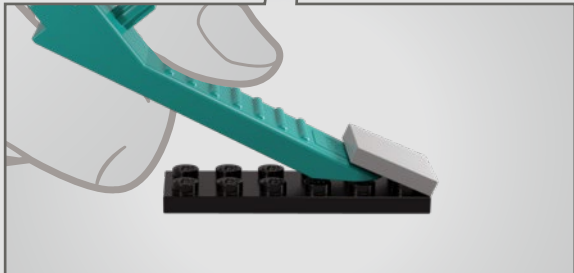
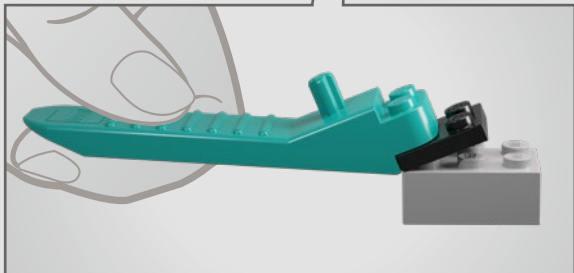
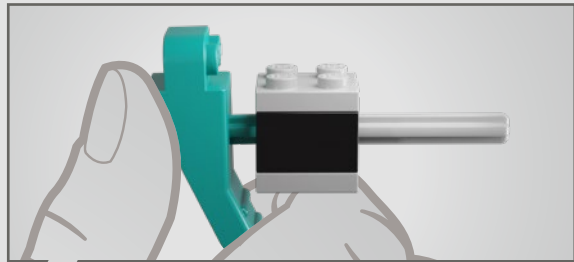
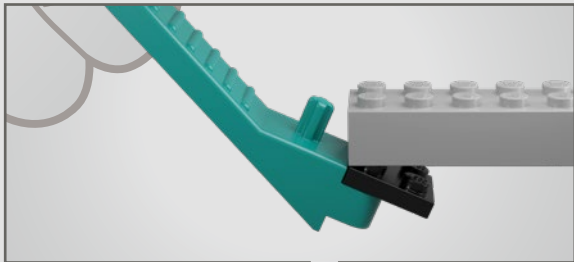



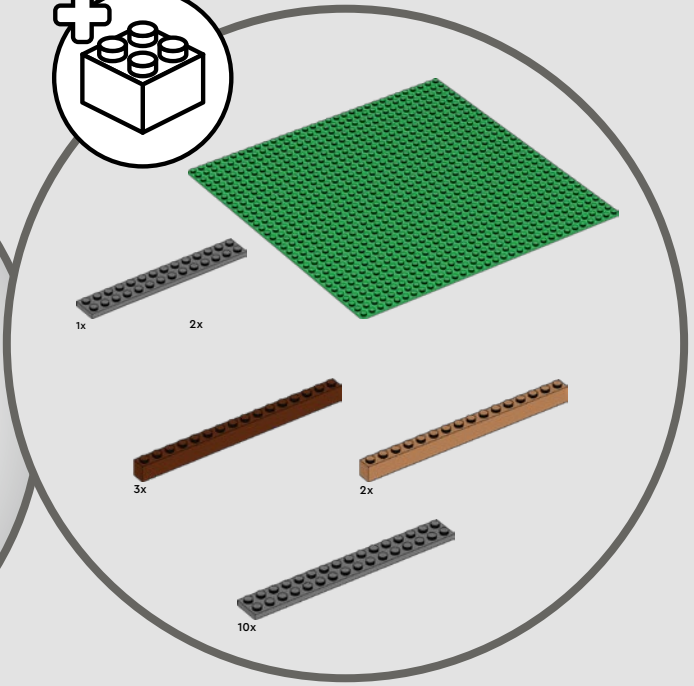
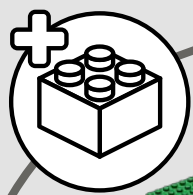

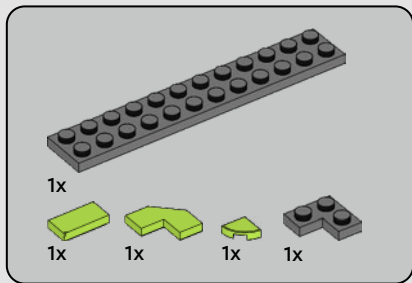

1

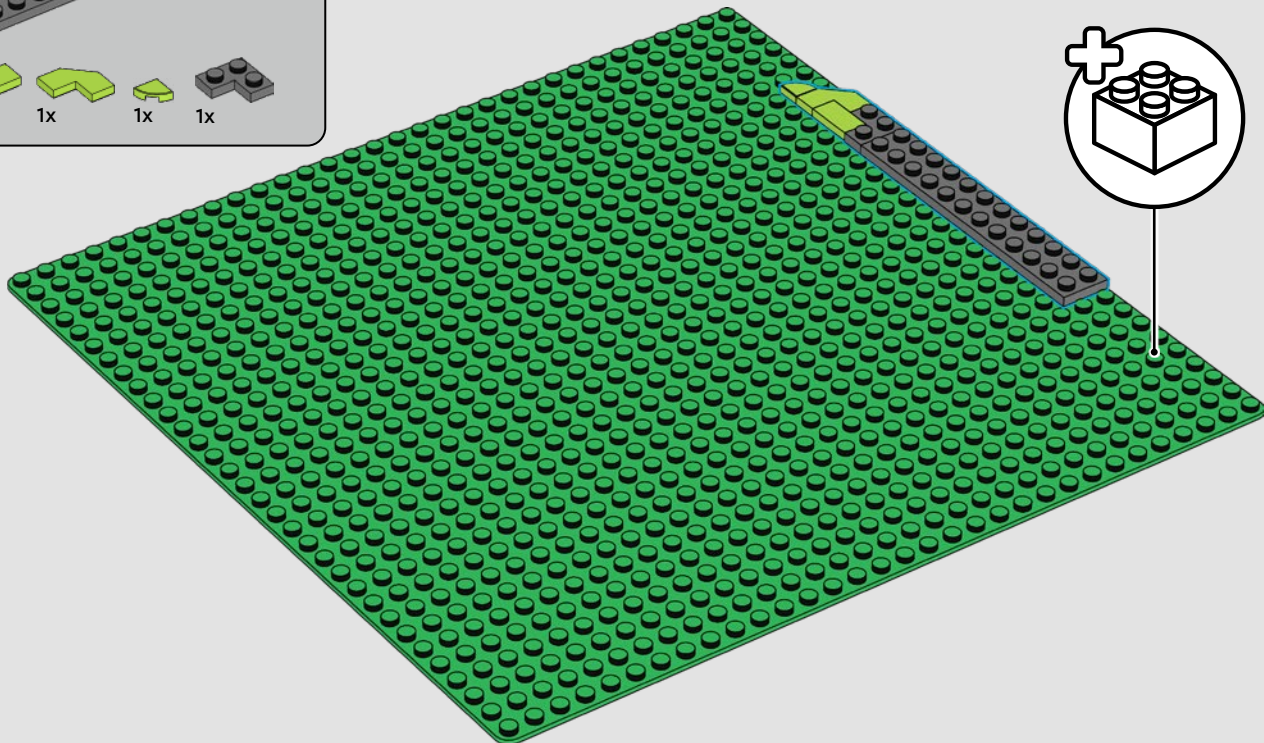

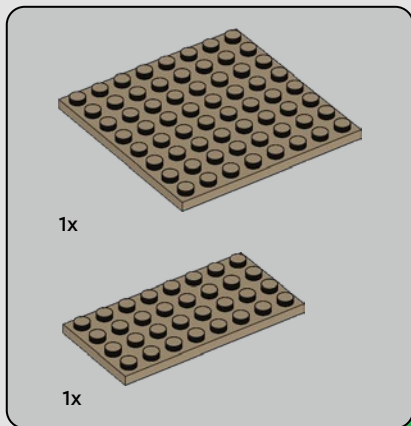

2

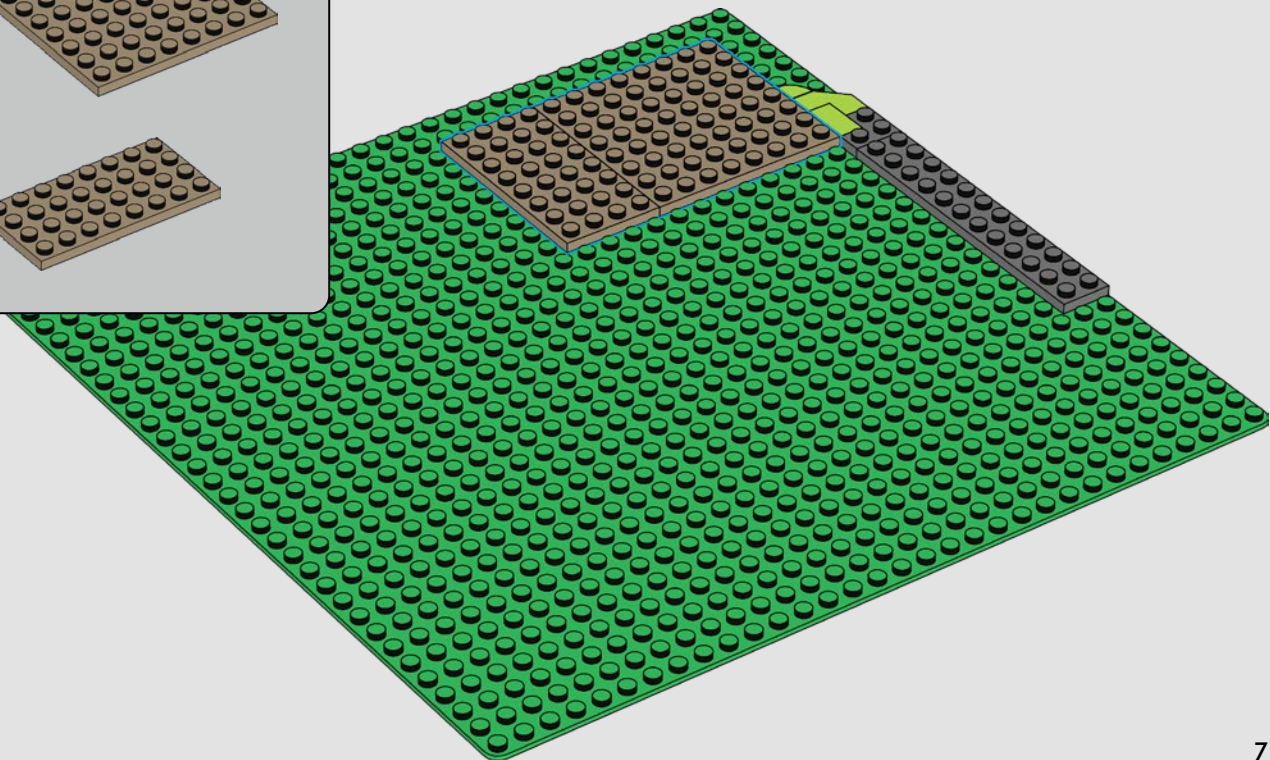

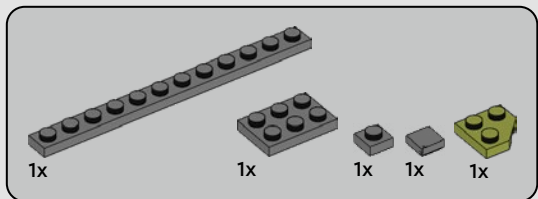

3

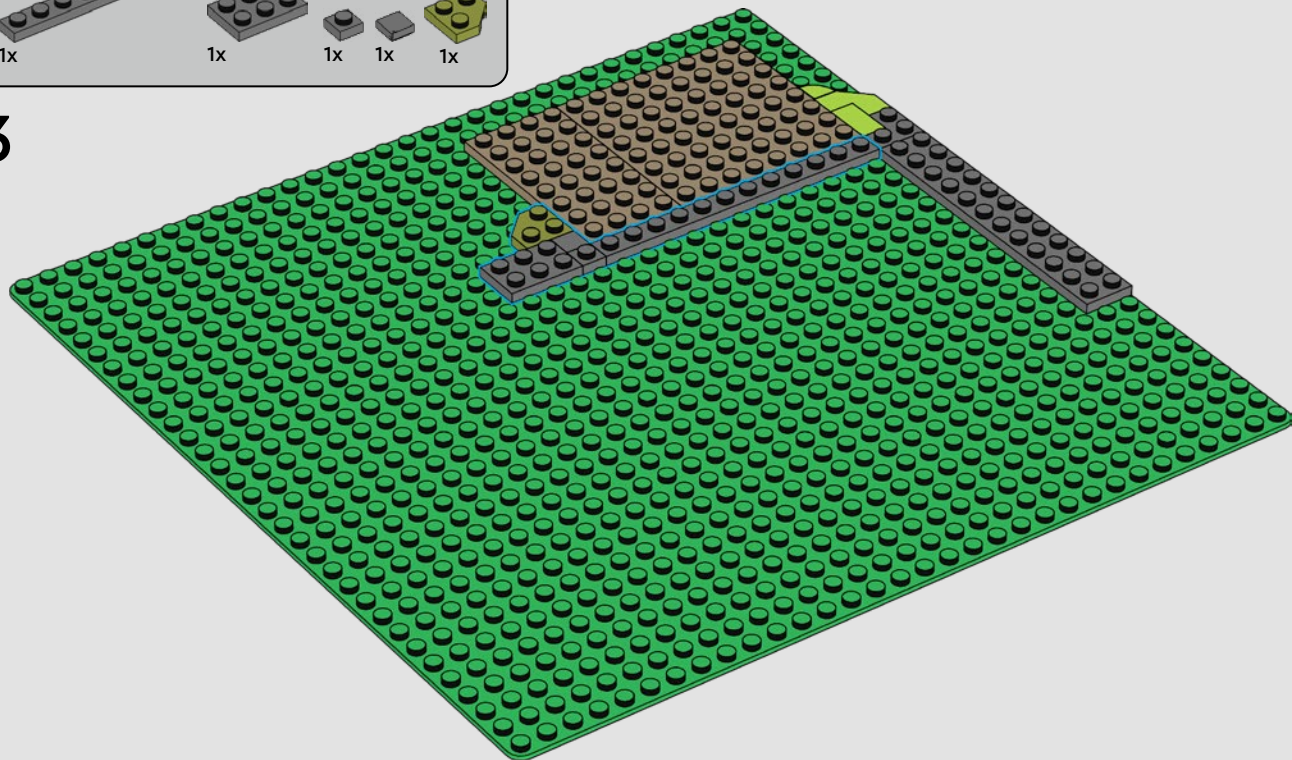

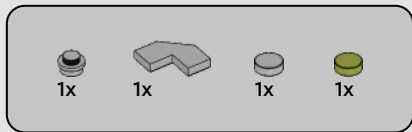

5

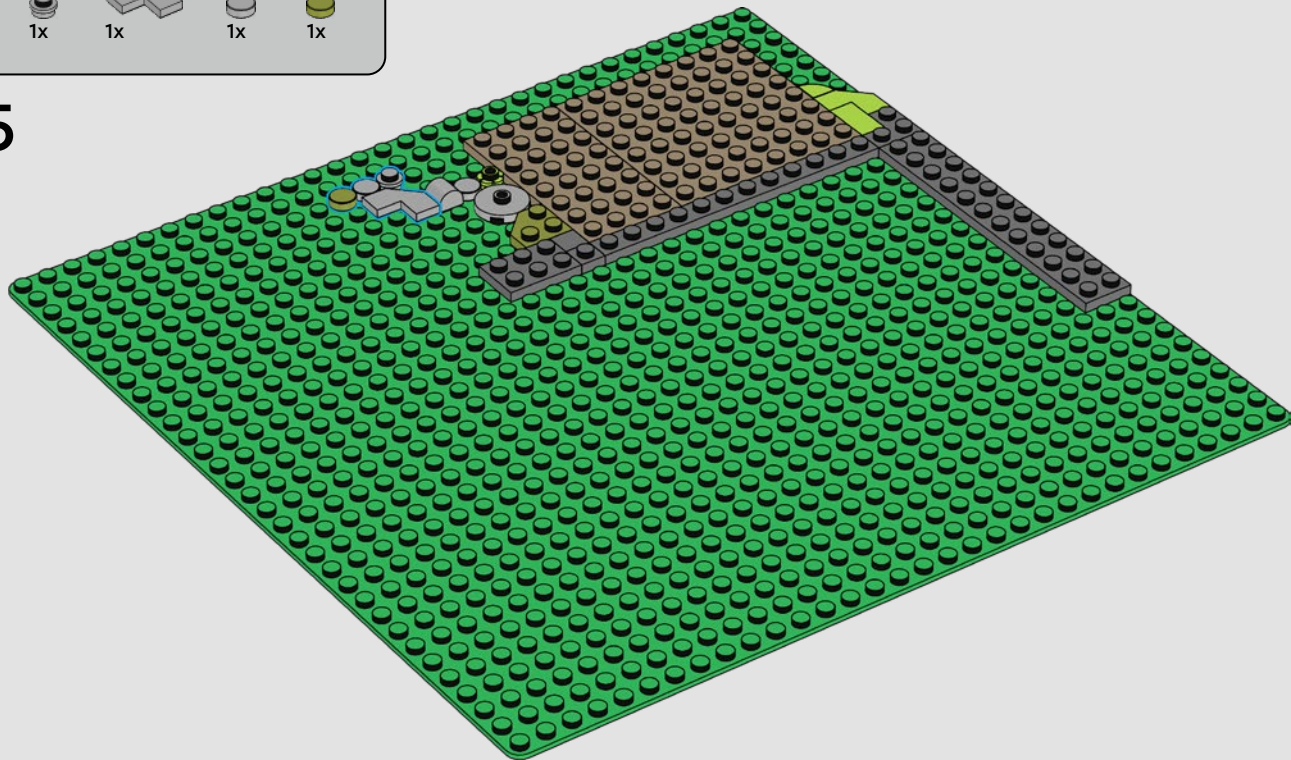

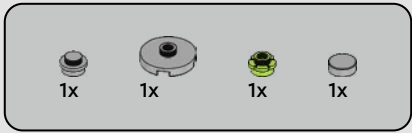

6

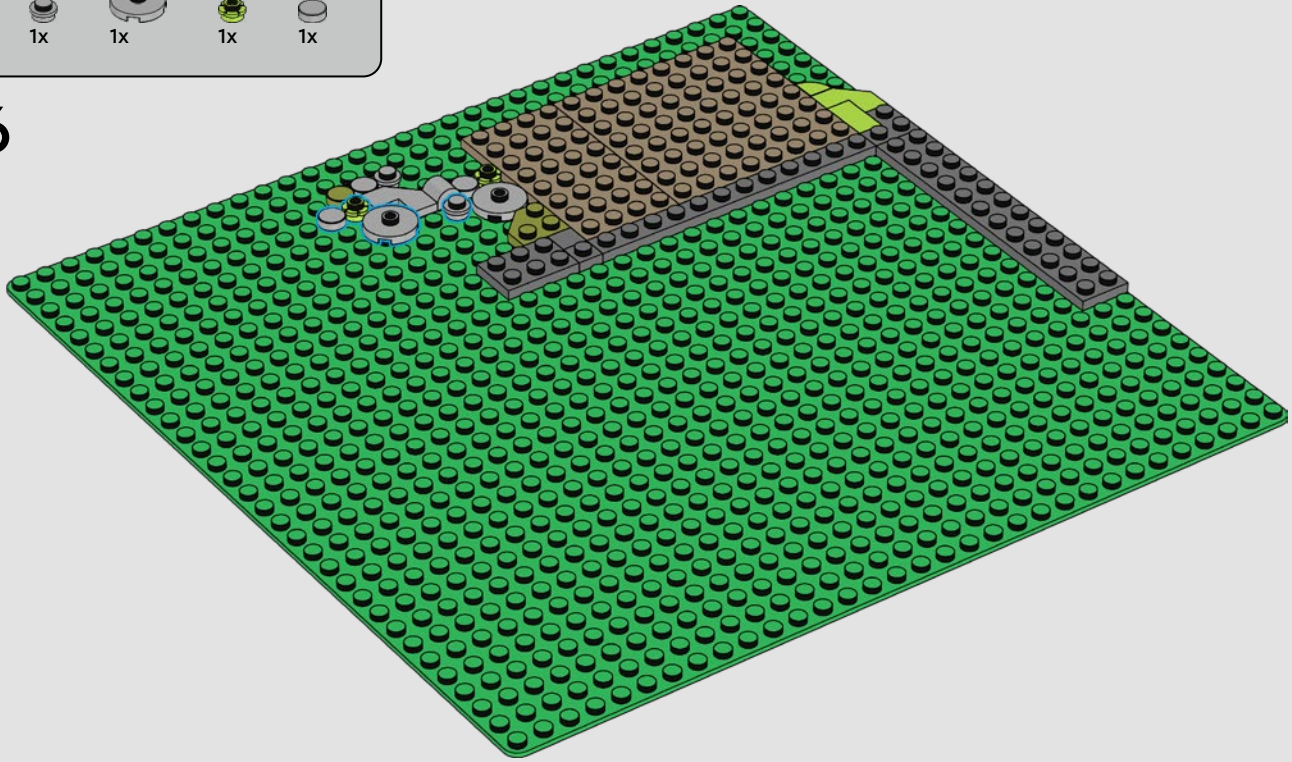

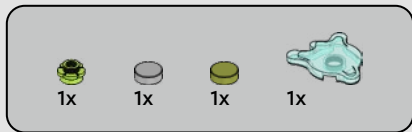

7

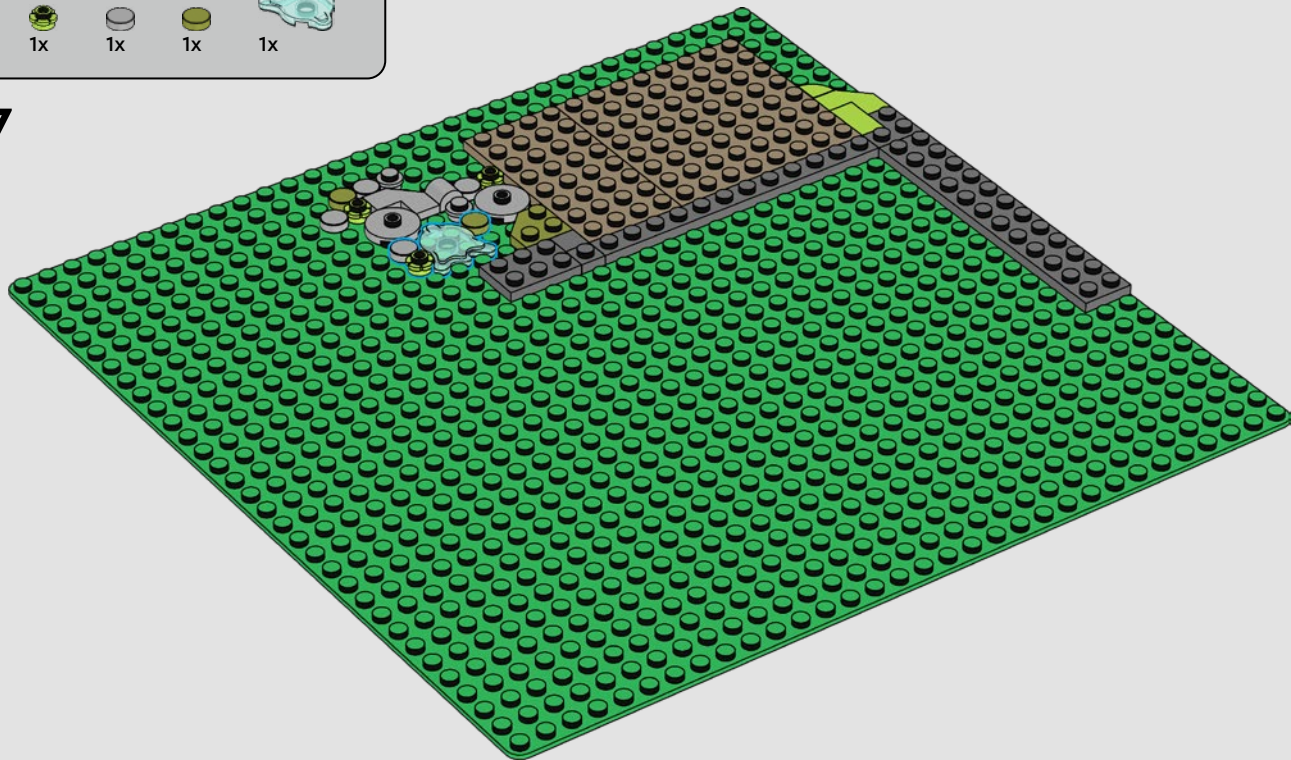

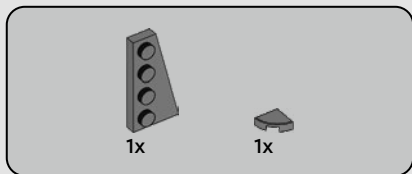

8

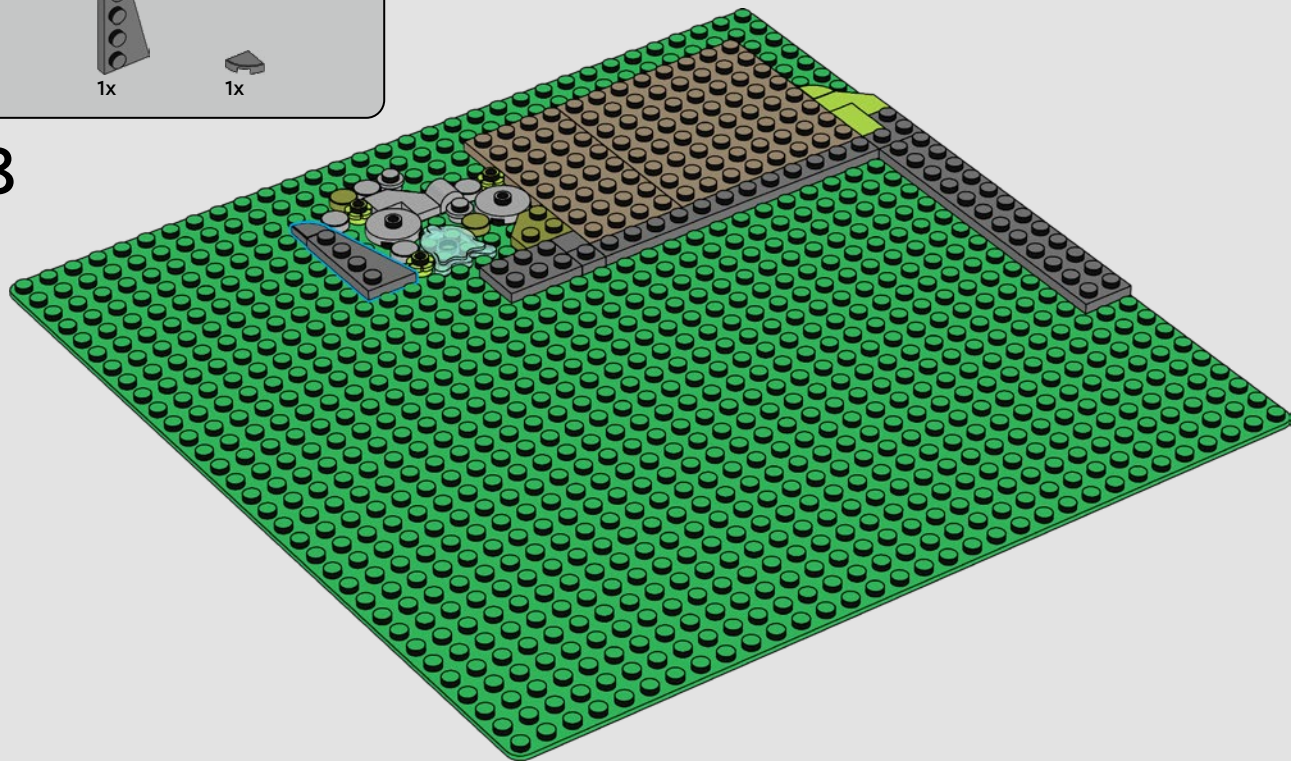

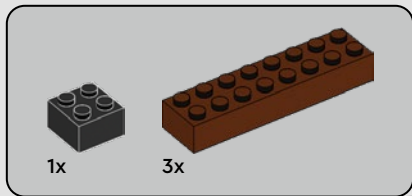

9

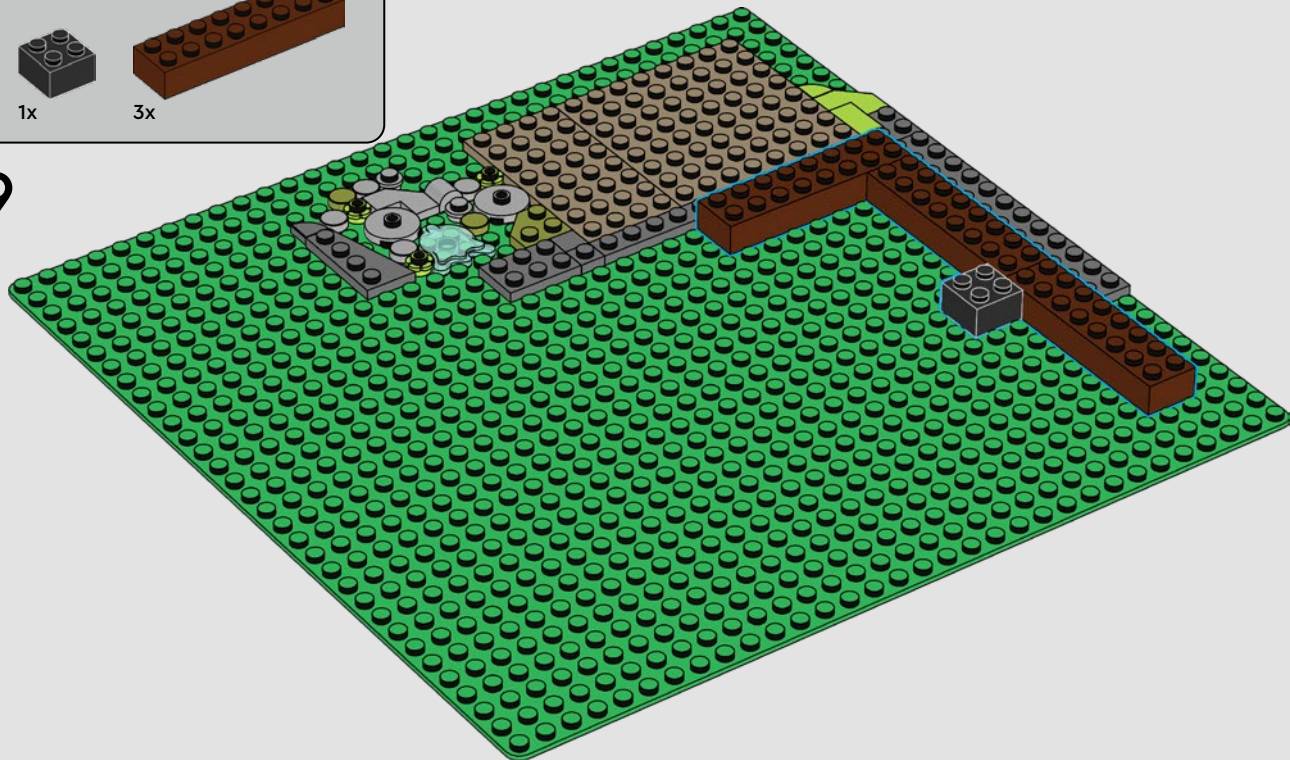

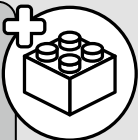
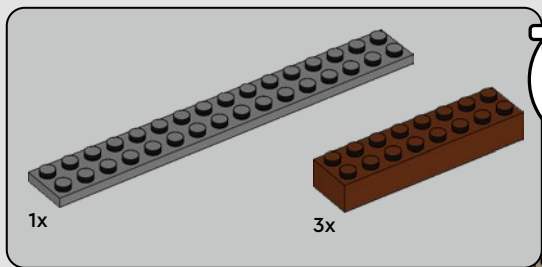

10

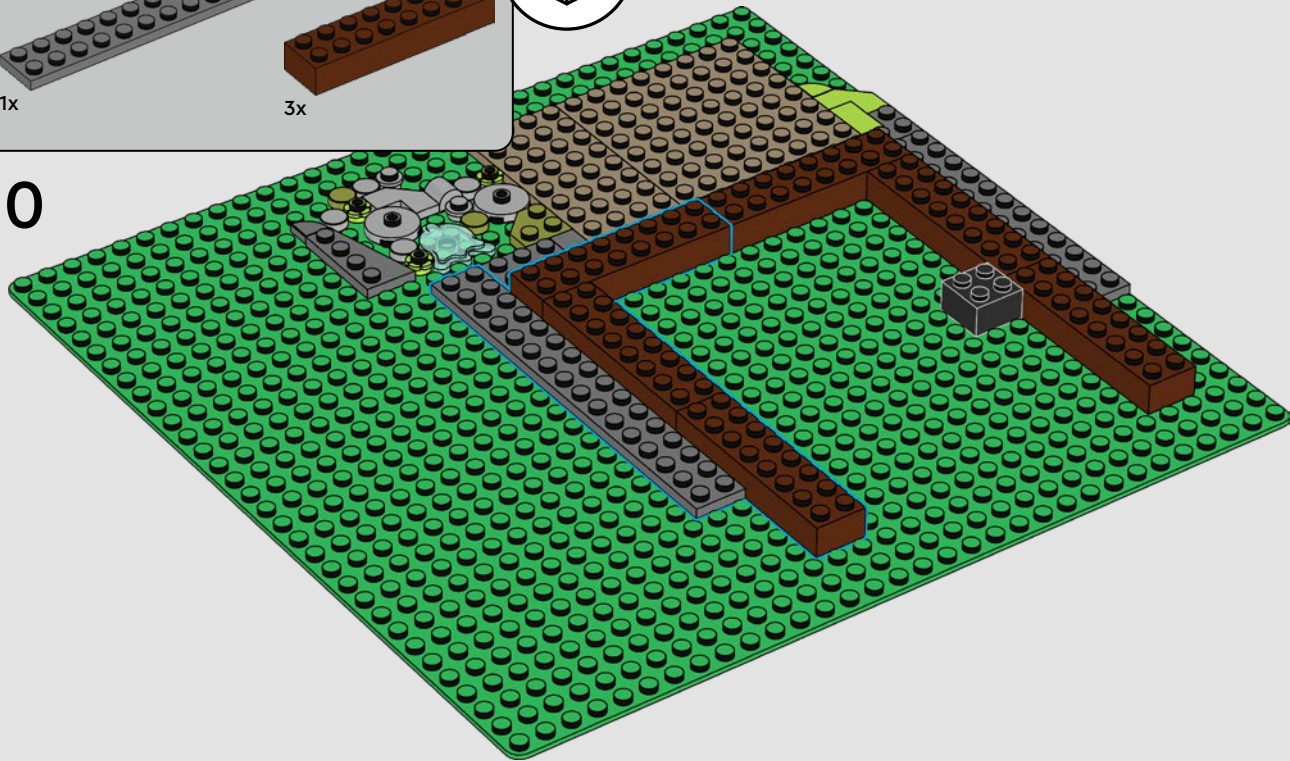

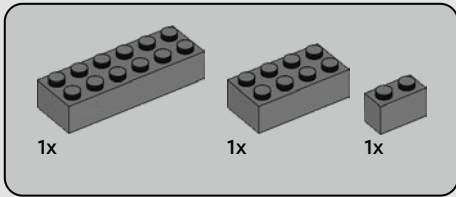

12

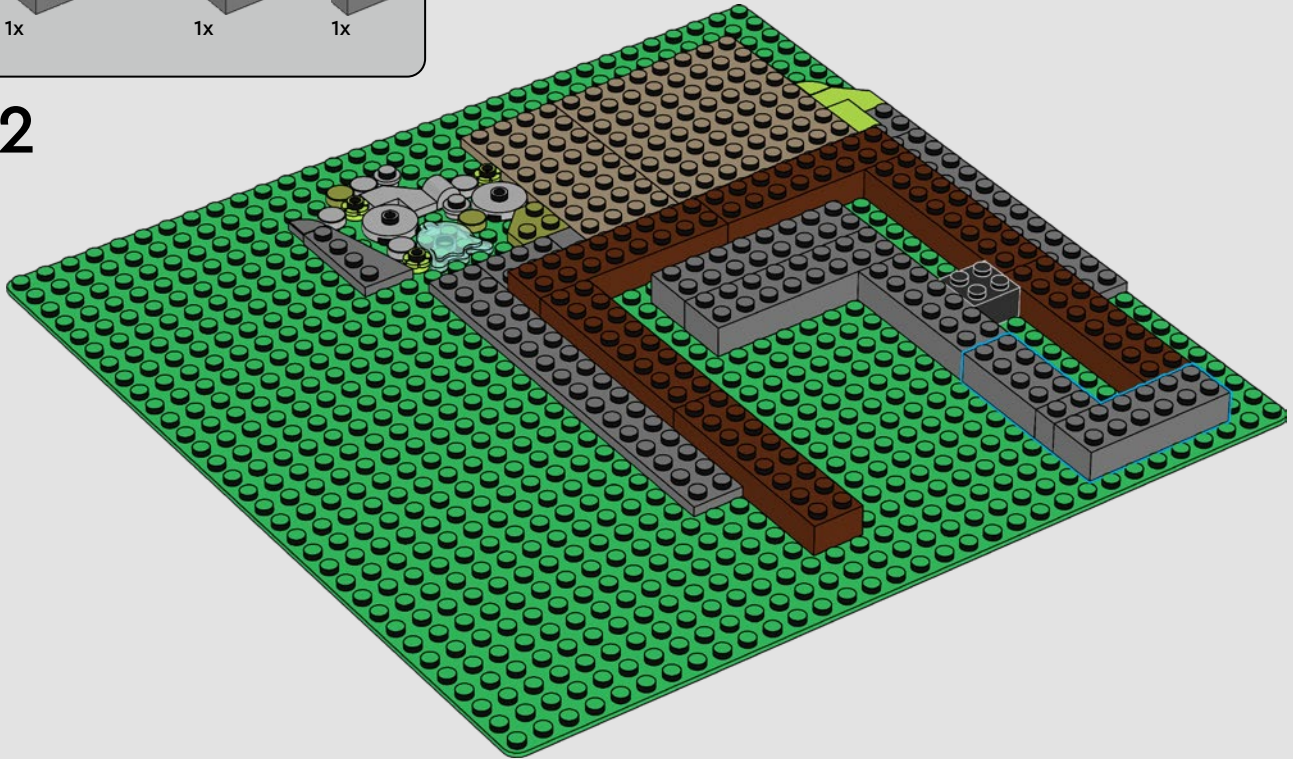

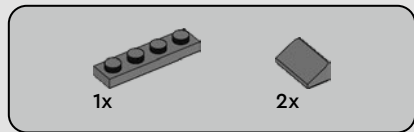

13

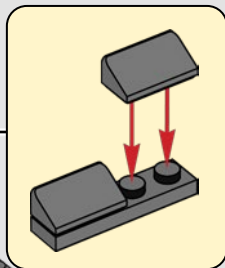
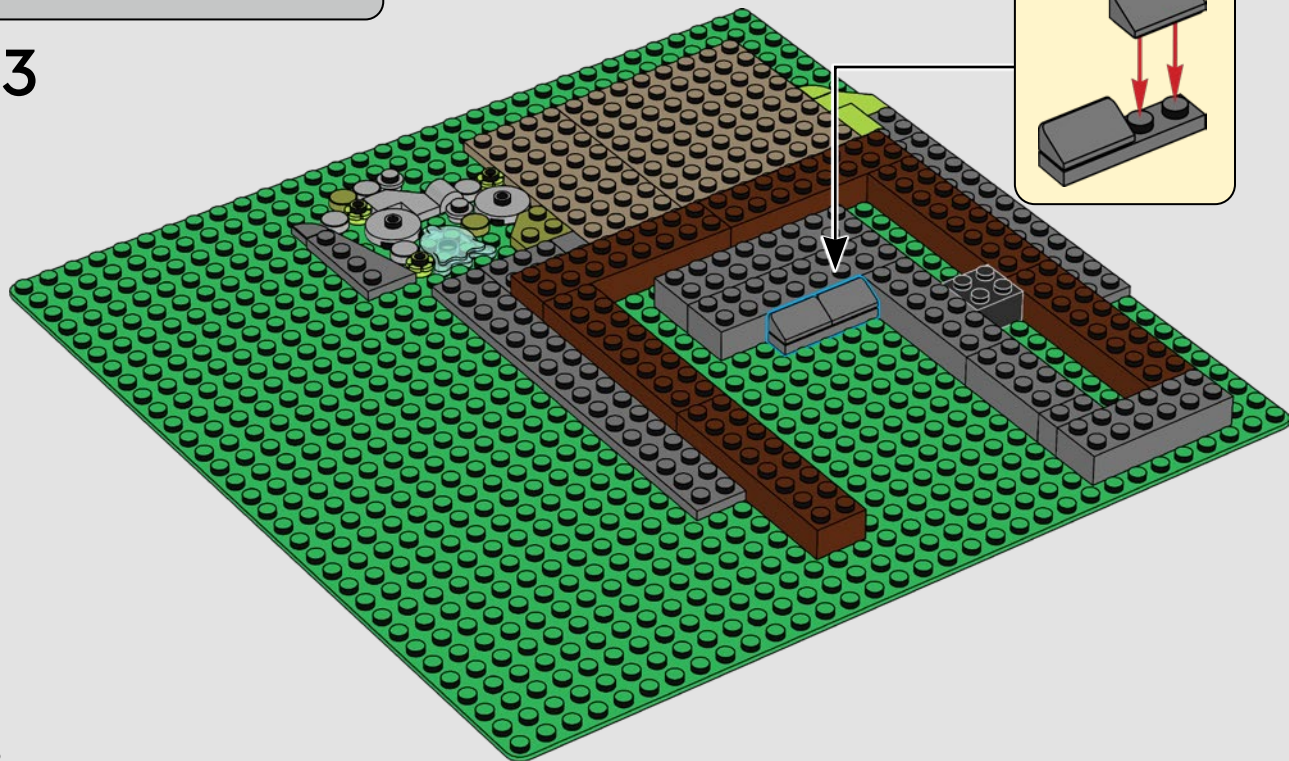

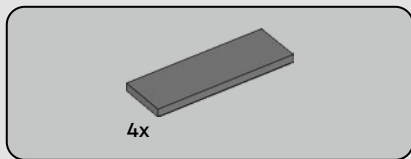

14

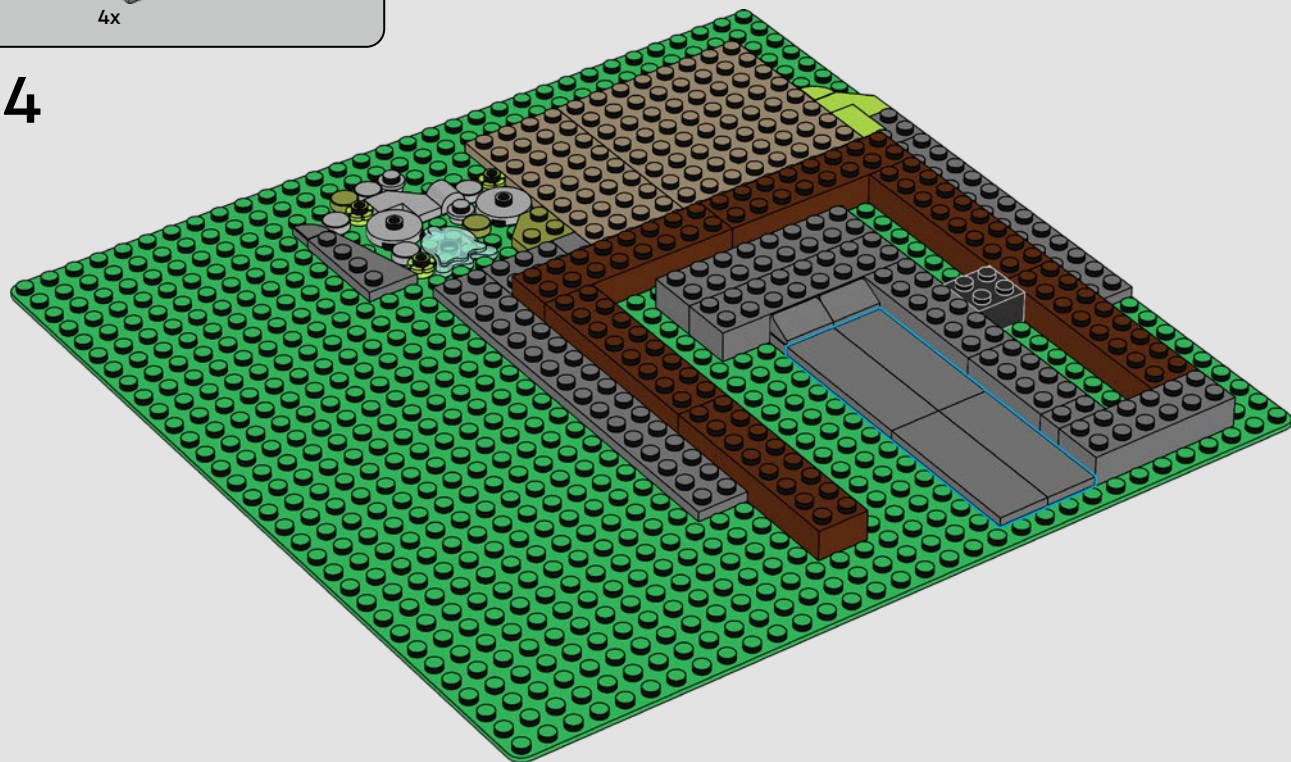

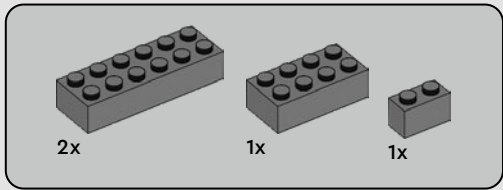

15

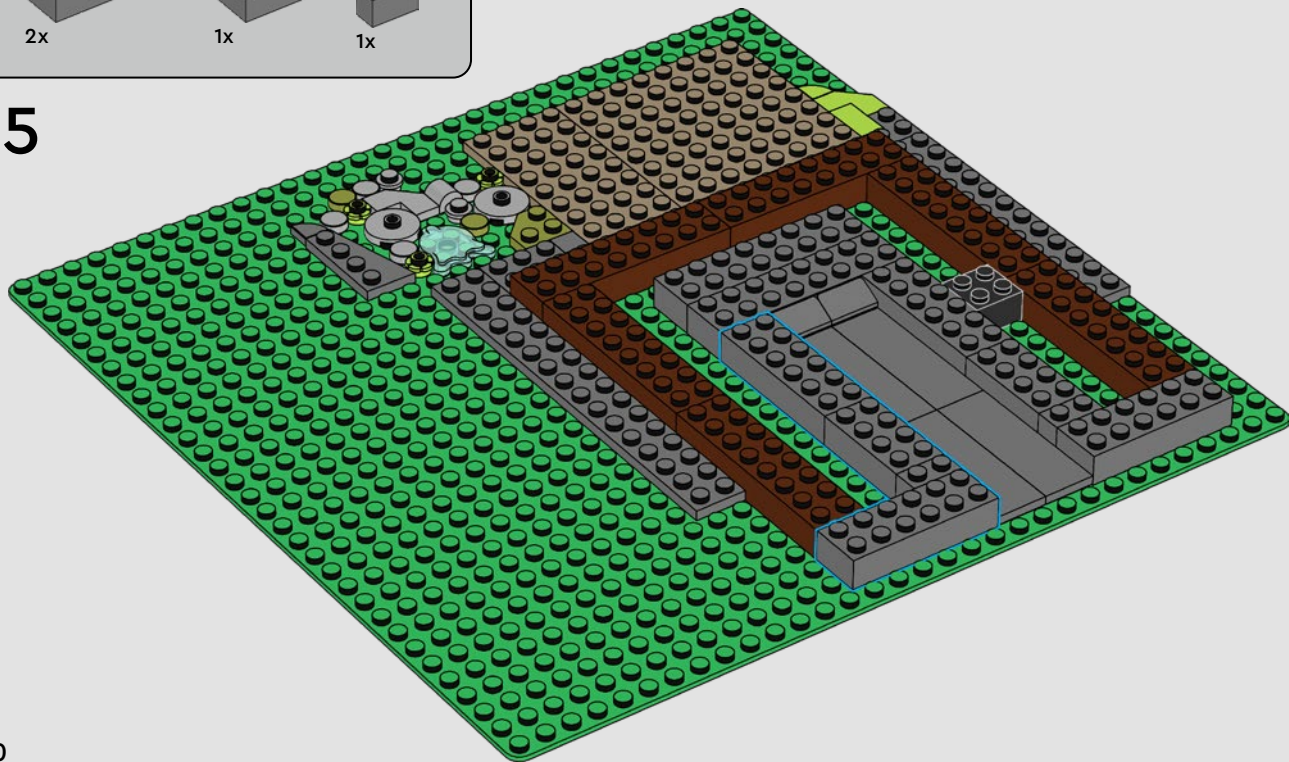

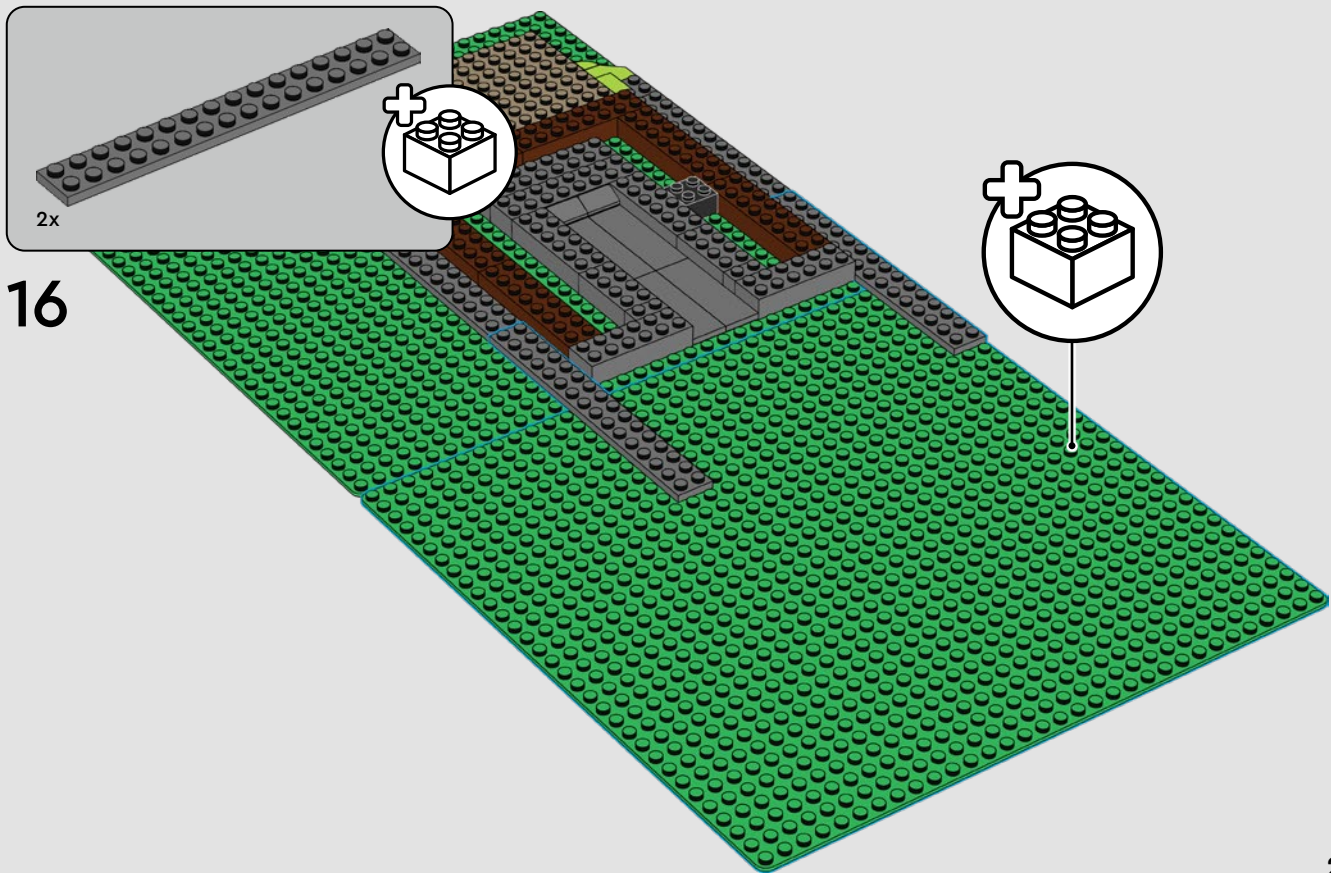

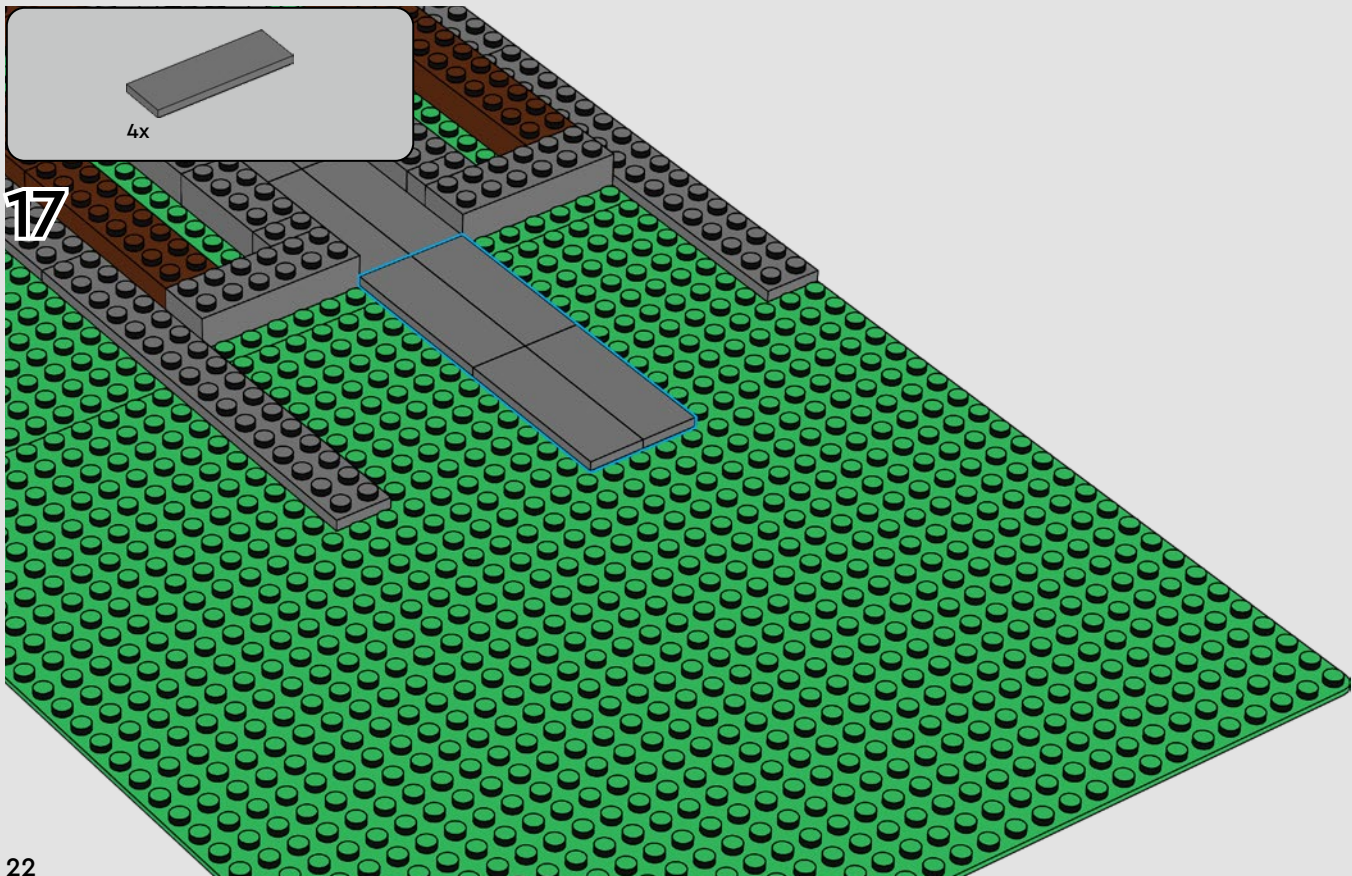

4x

17

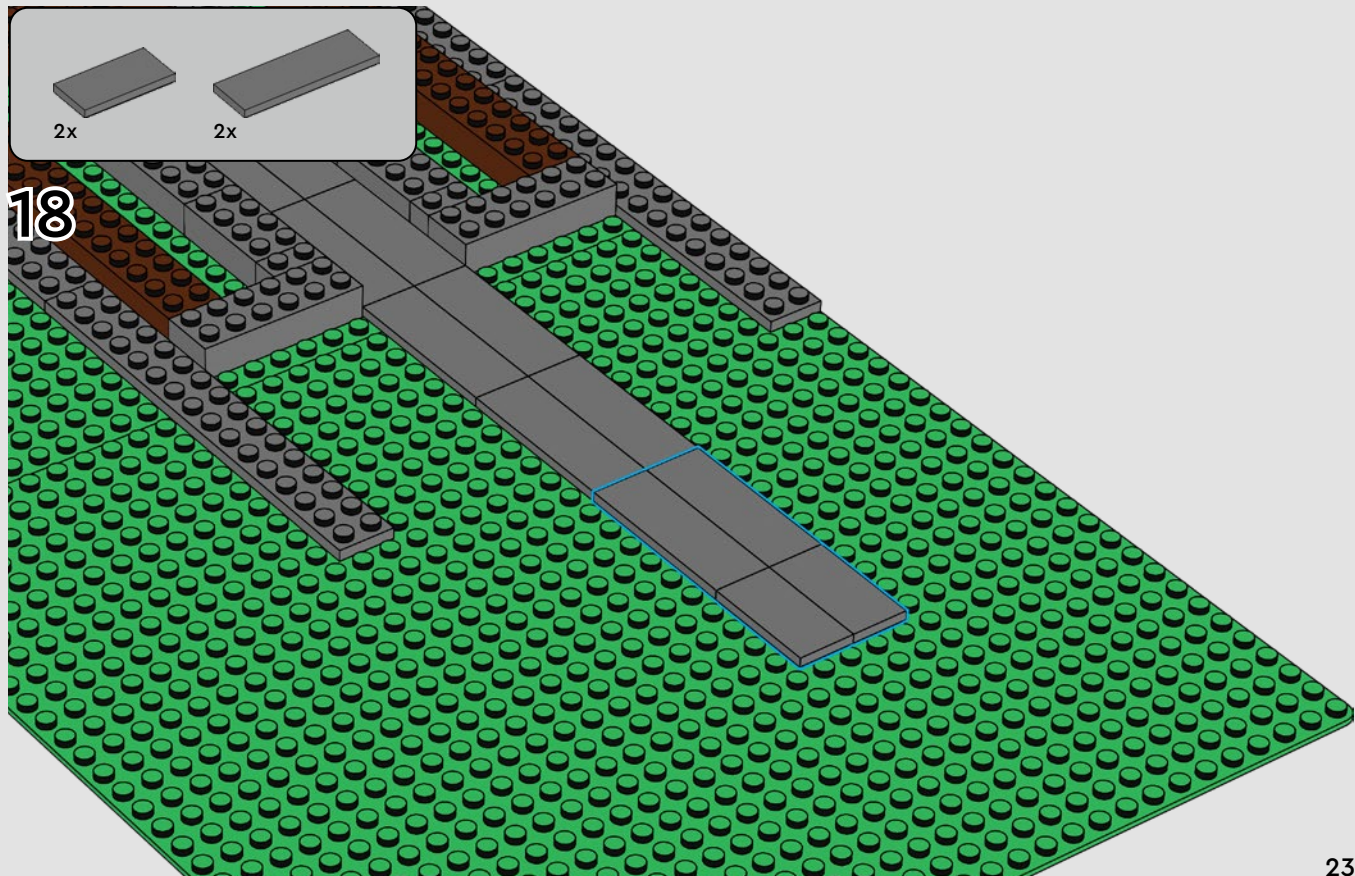

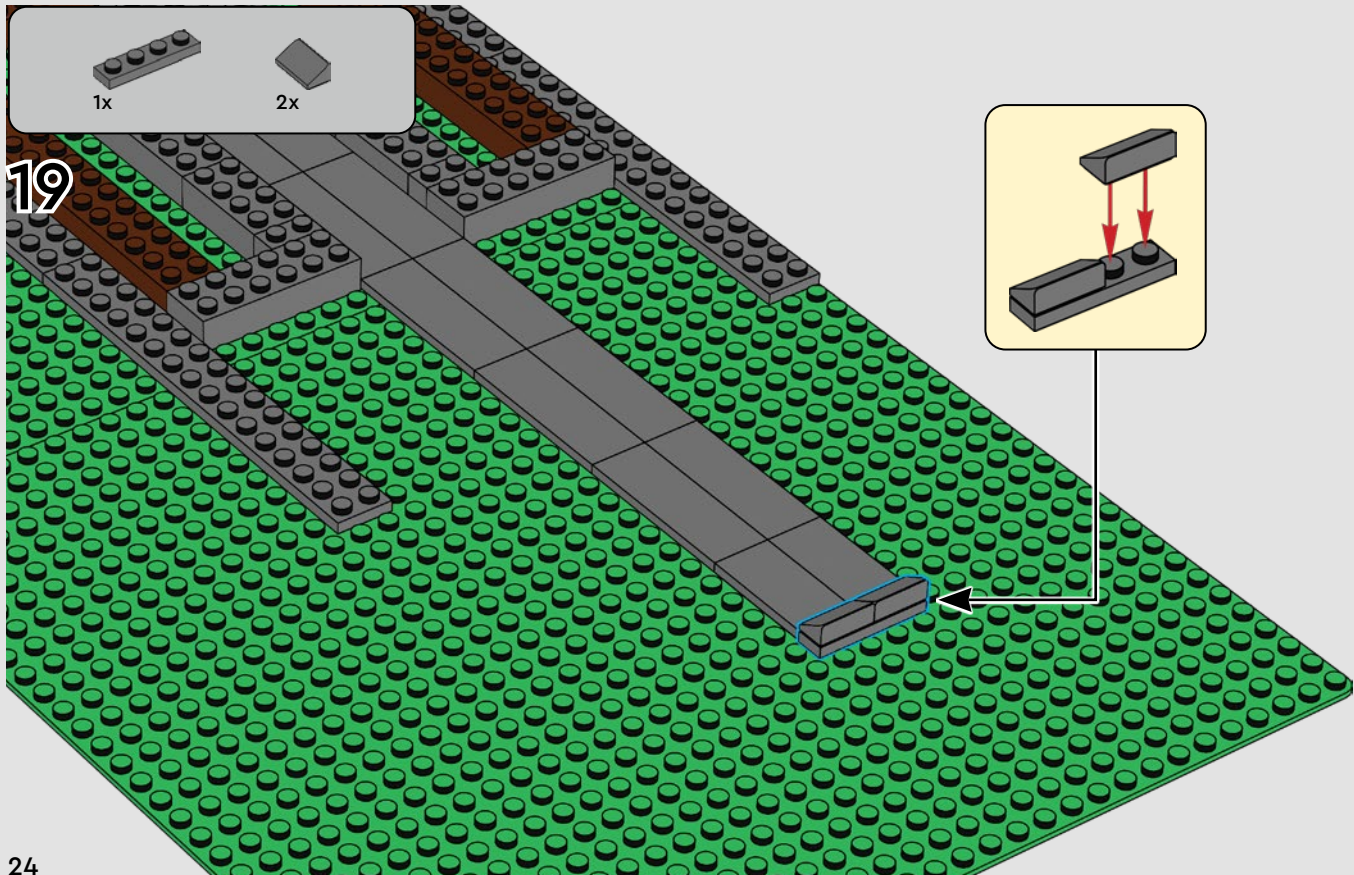

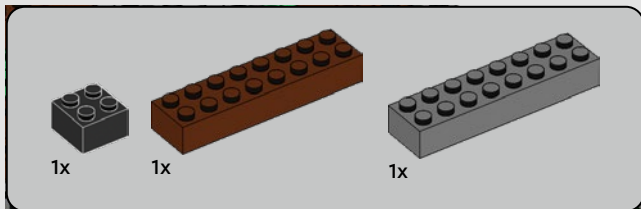

20

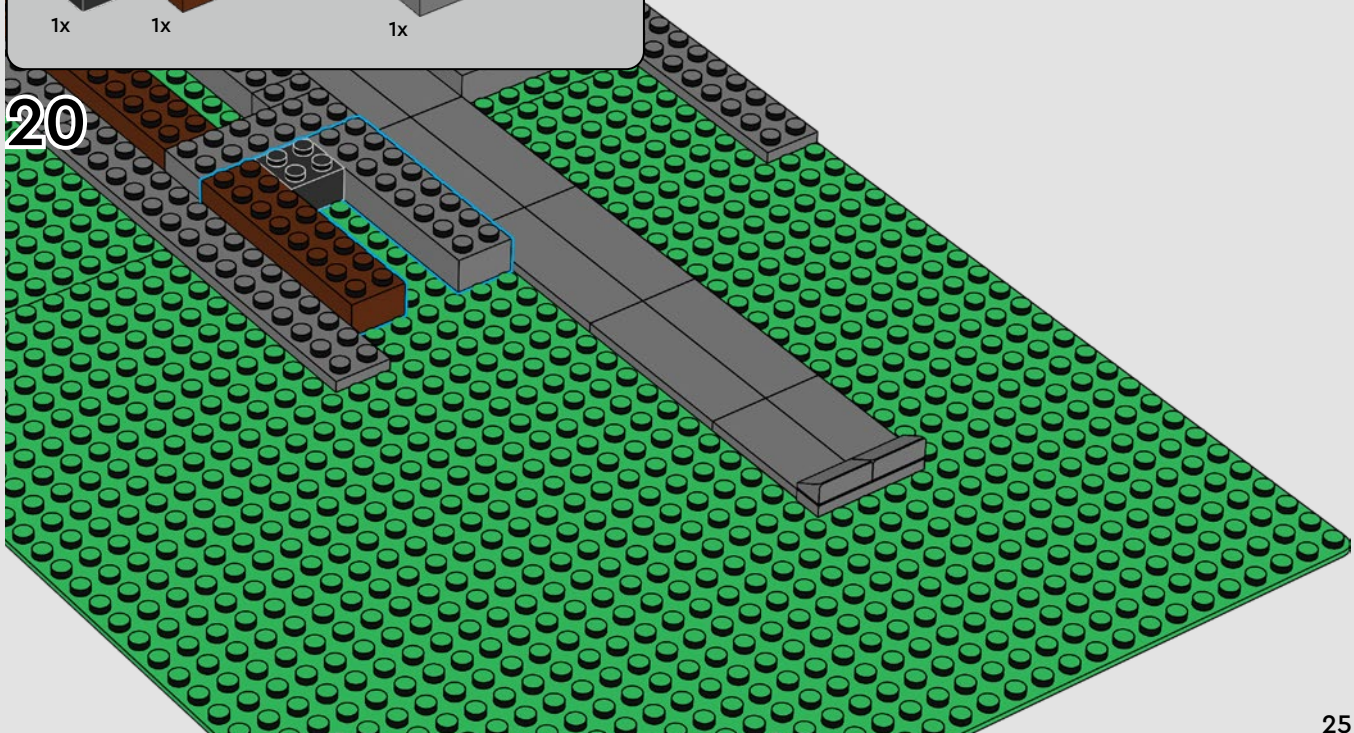

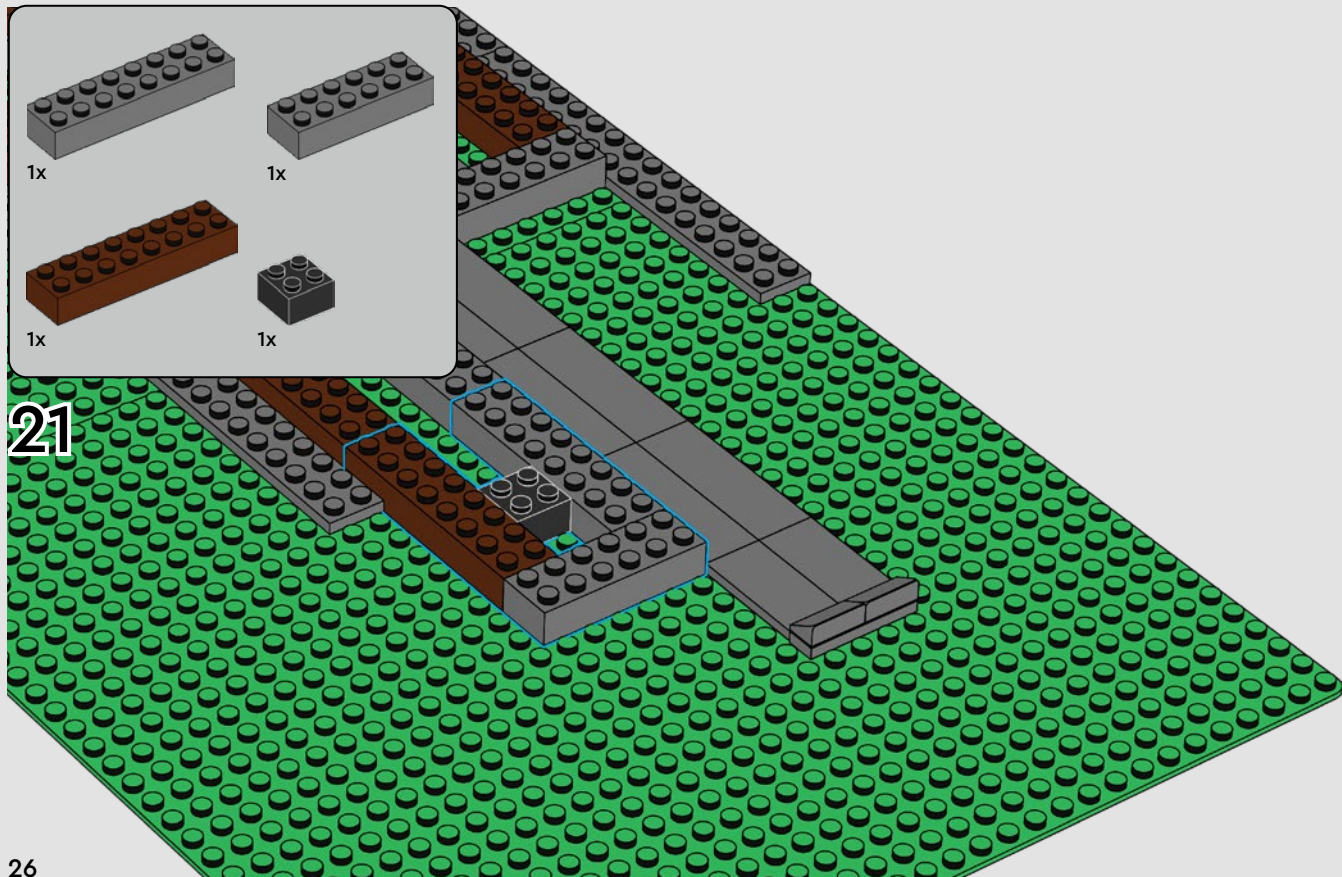

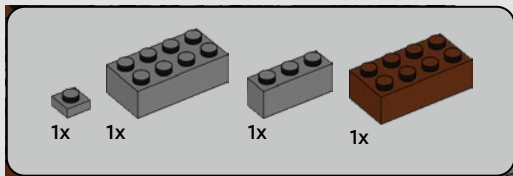

22

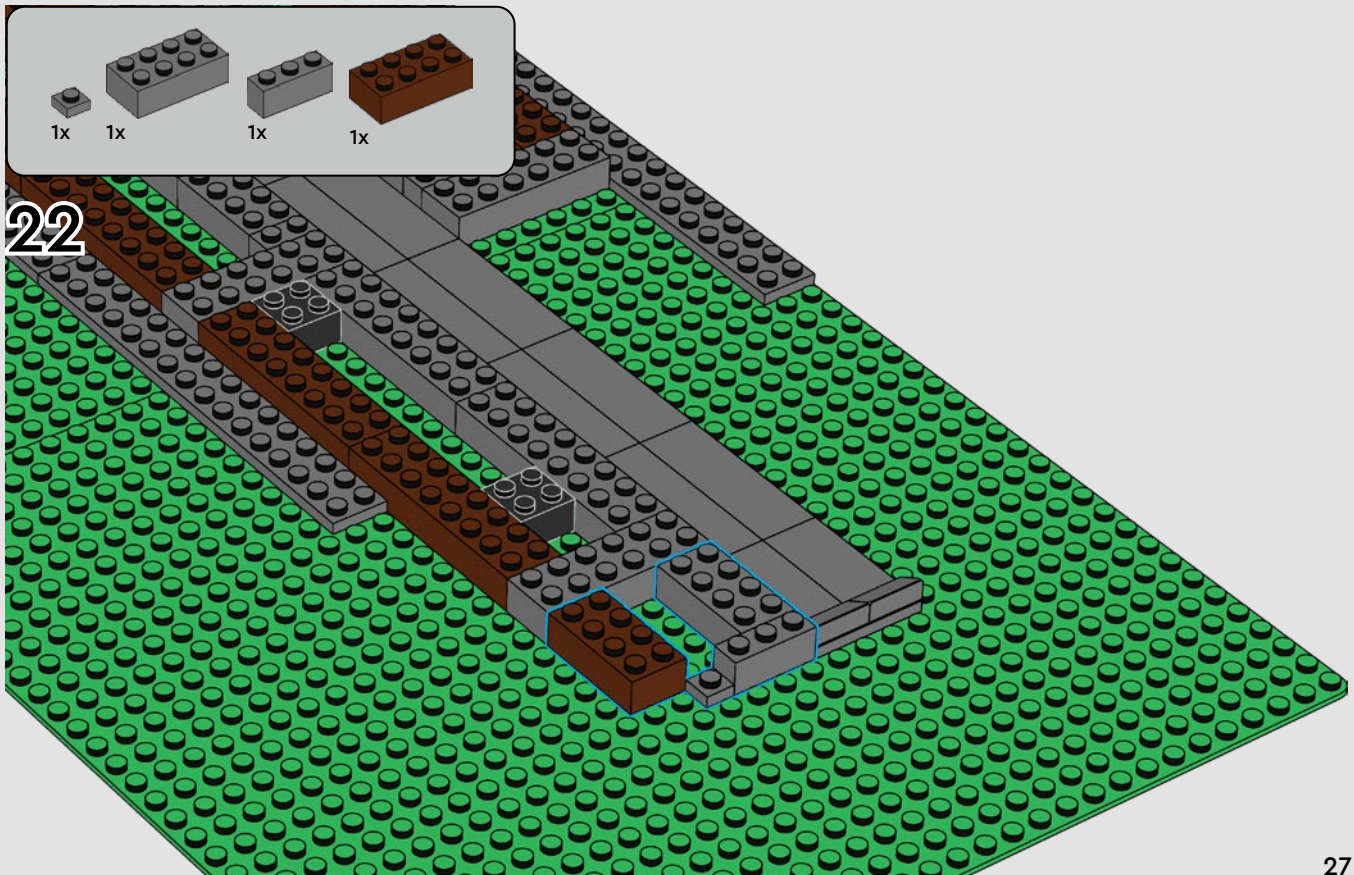

23

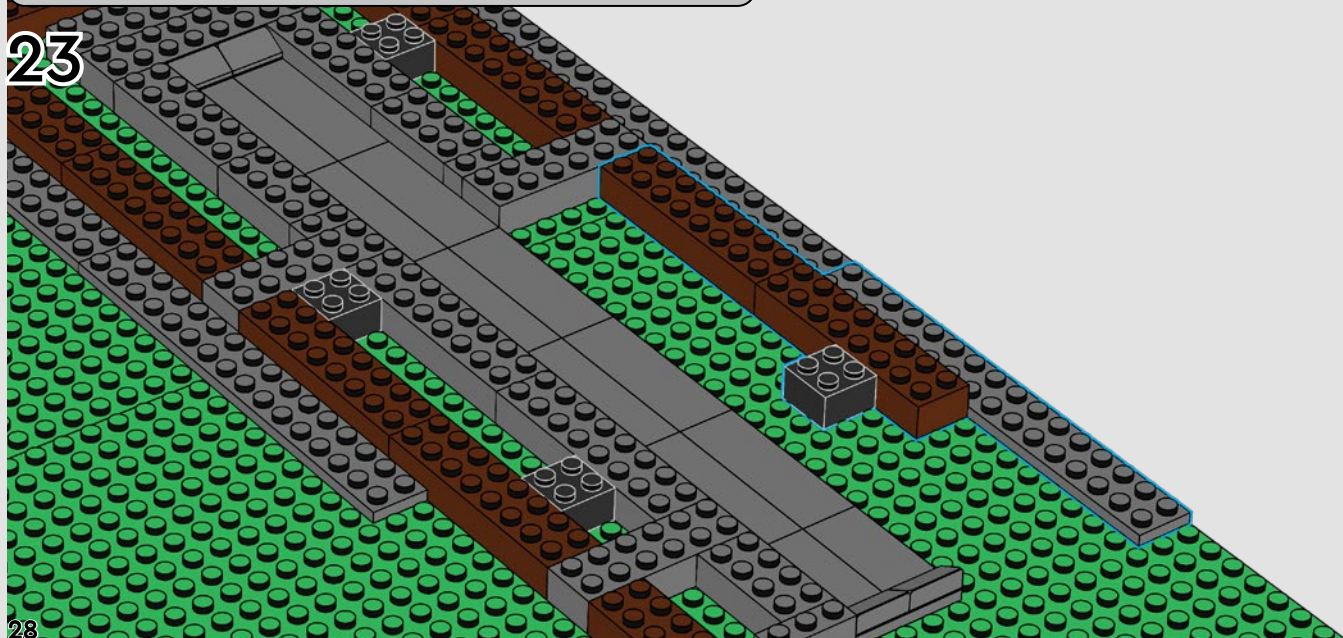

28

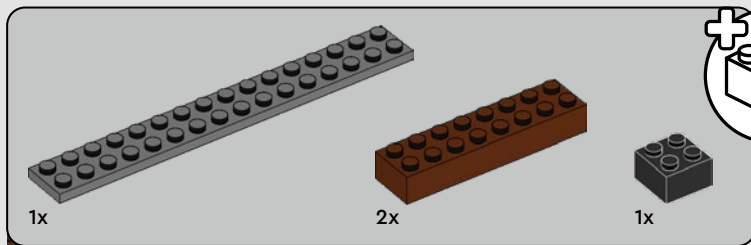

1x

2x

1x



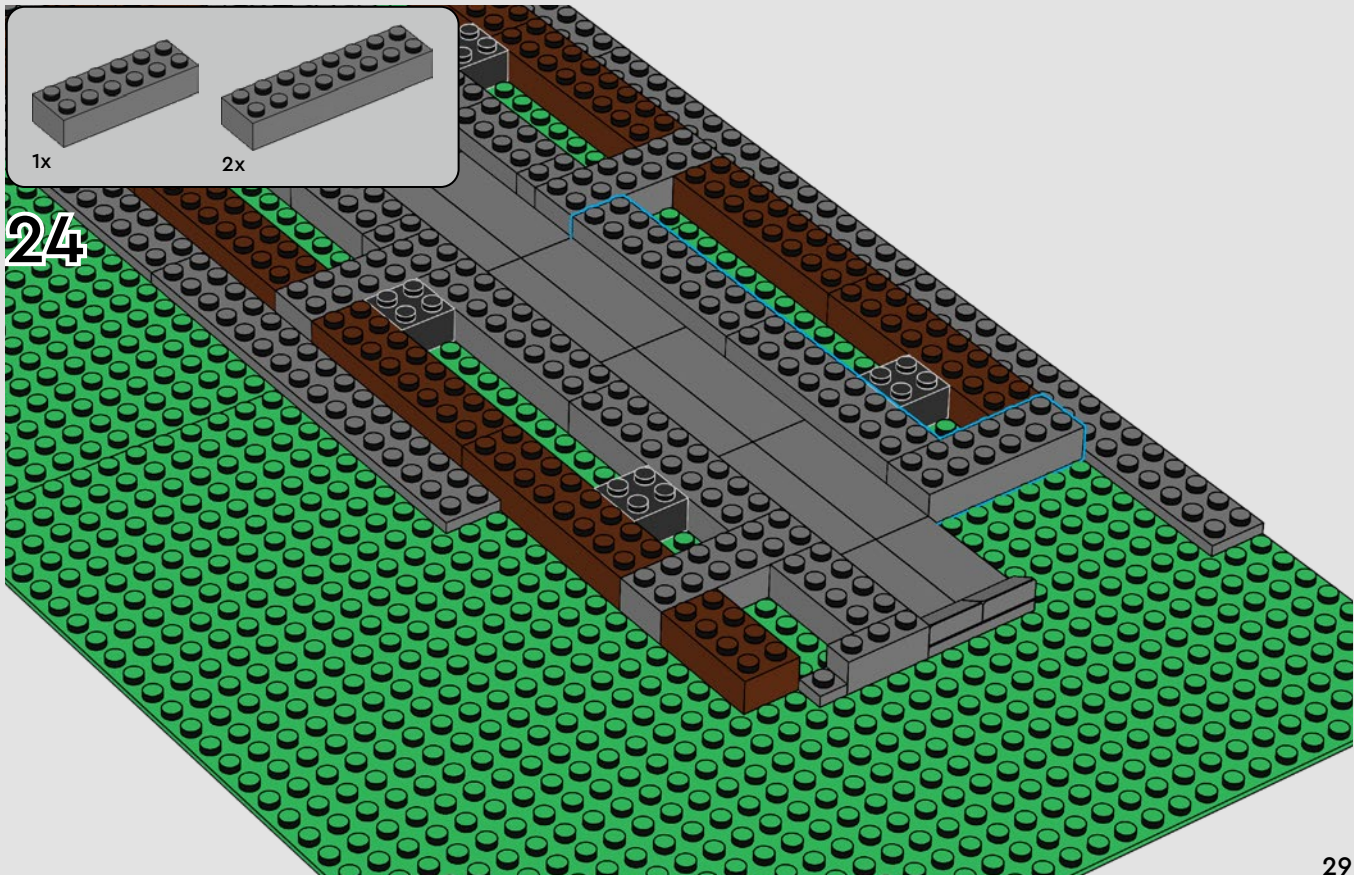

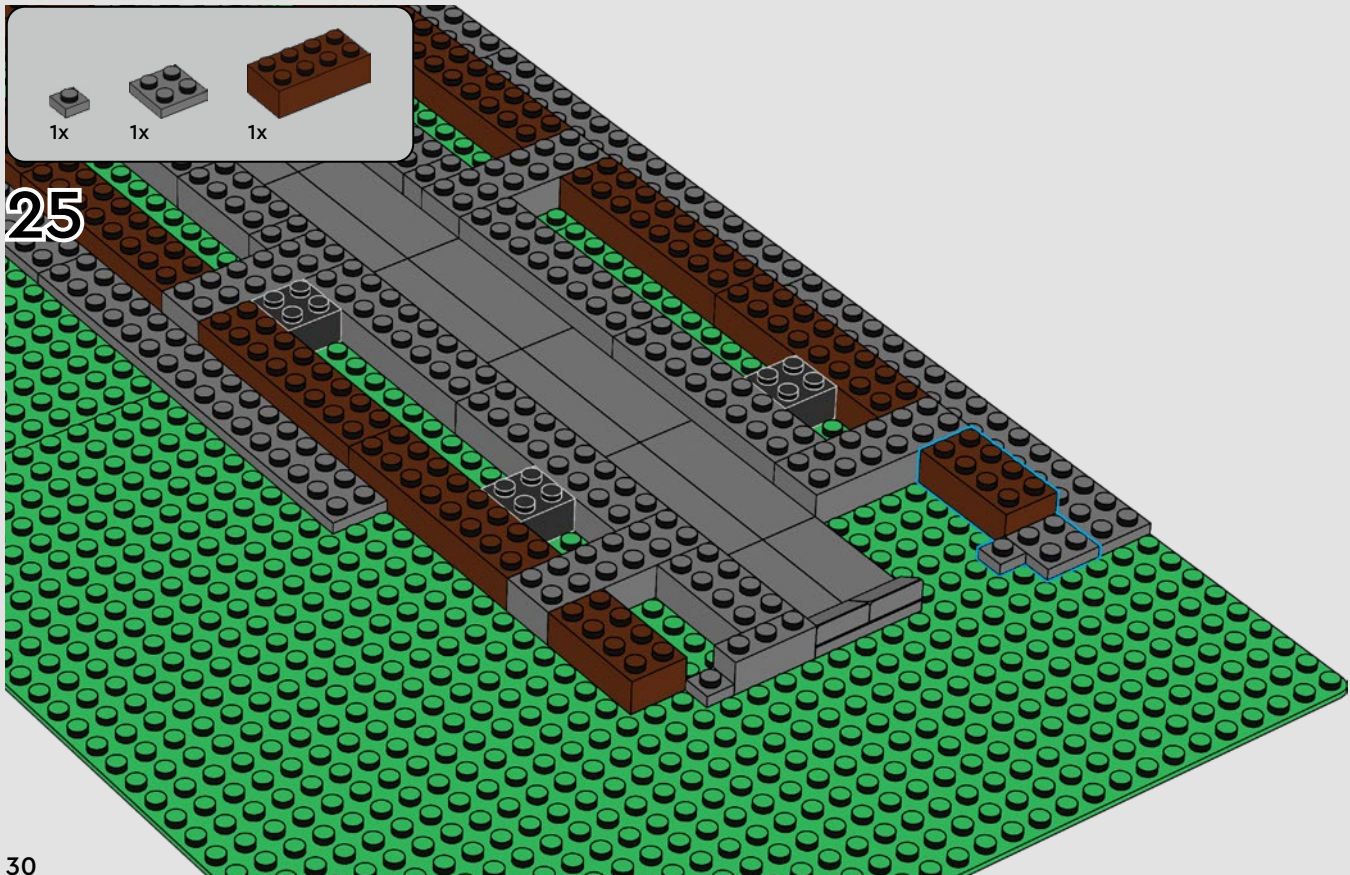

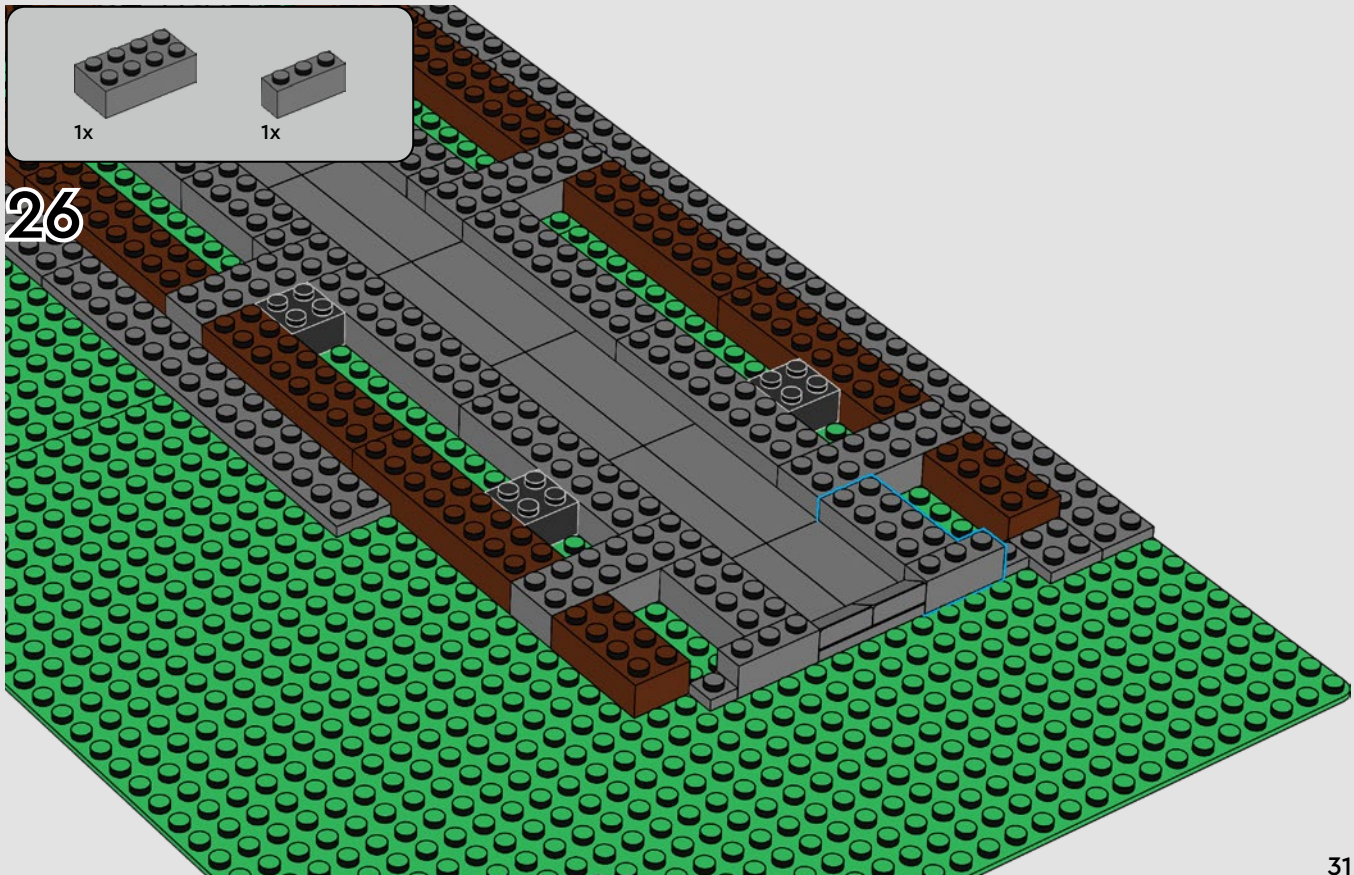

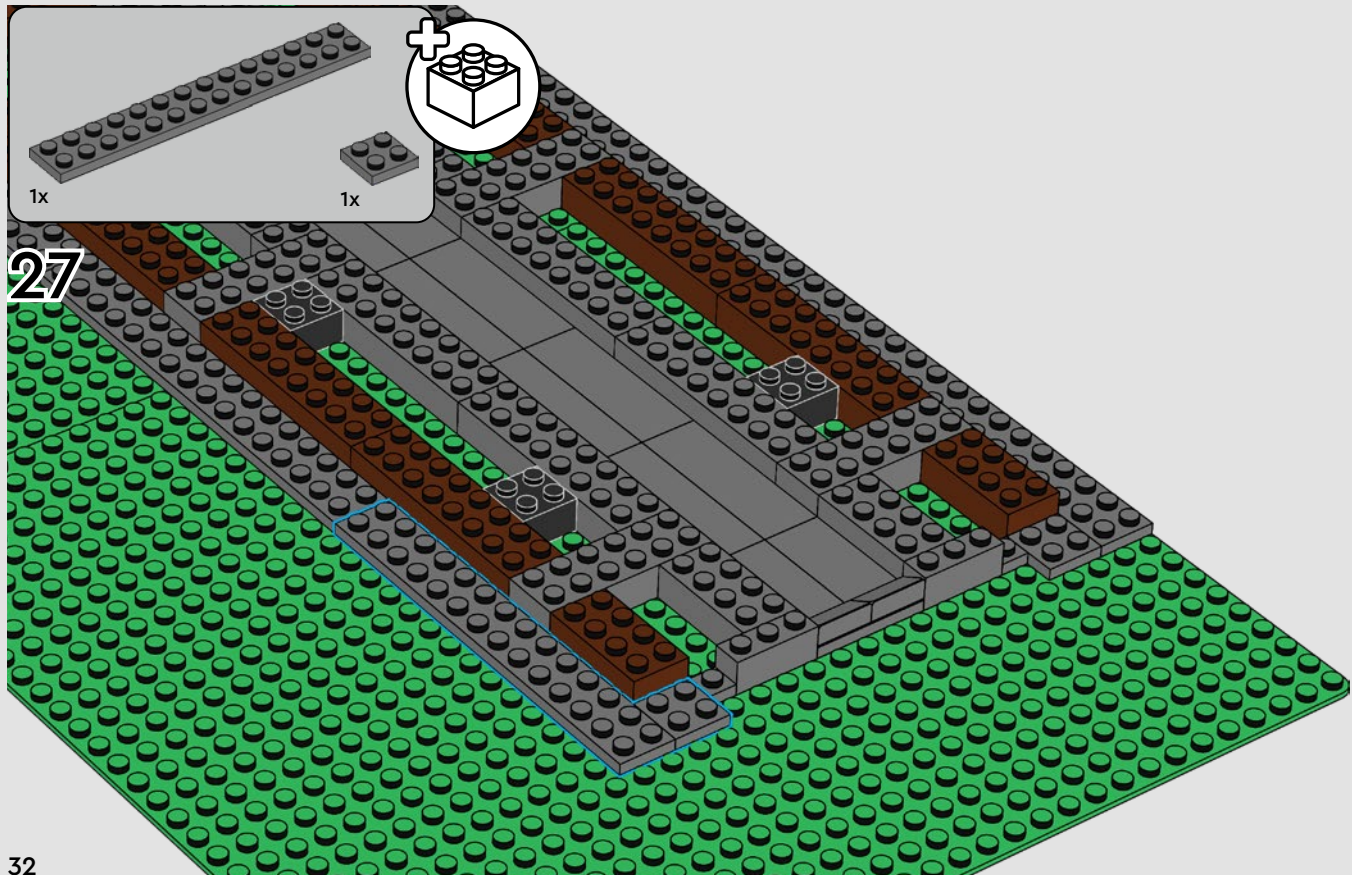

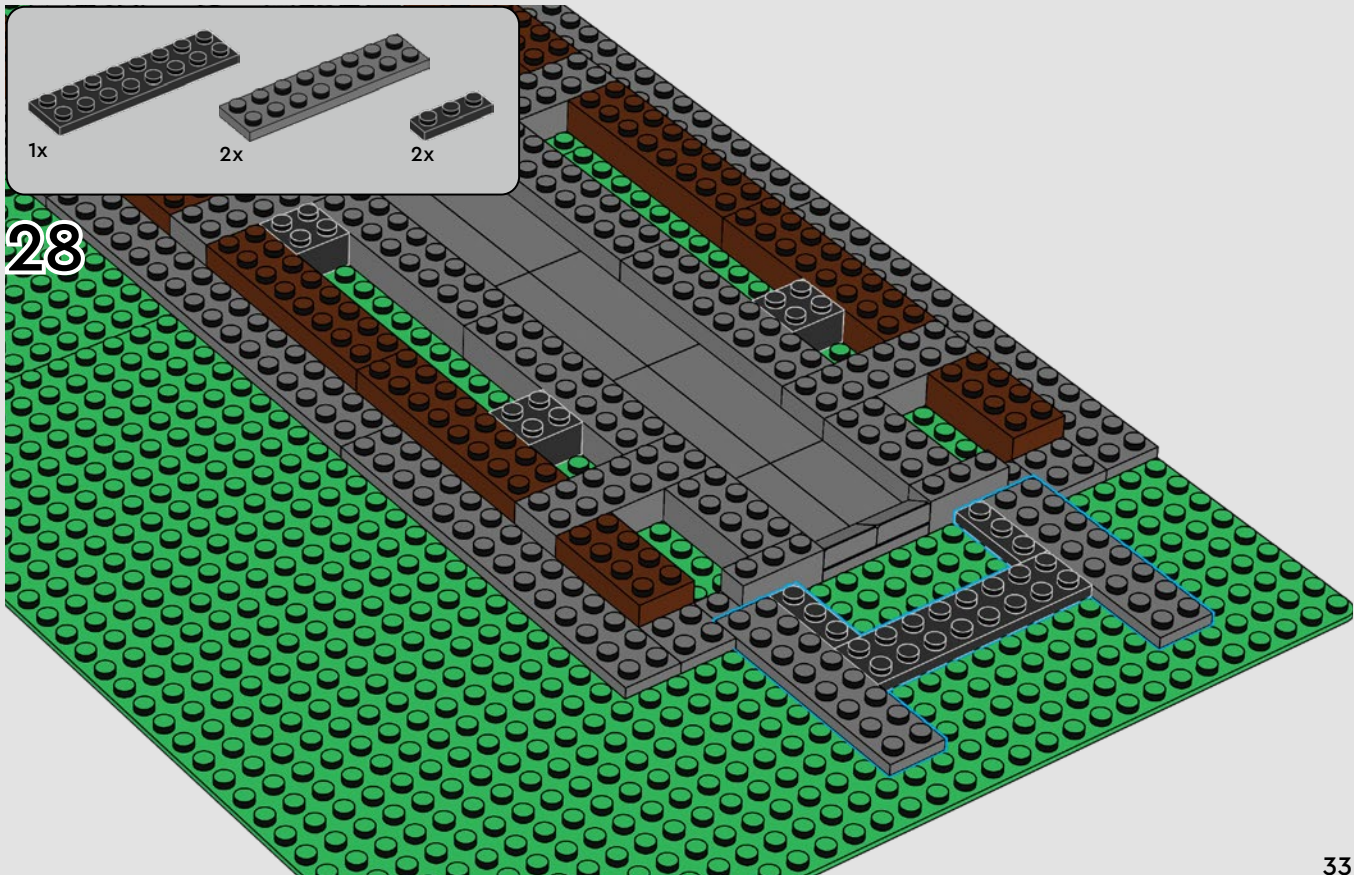

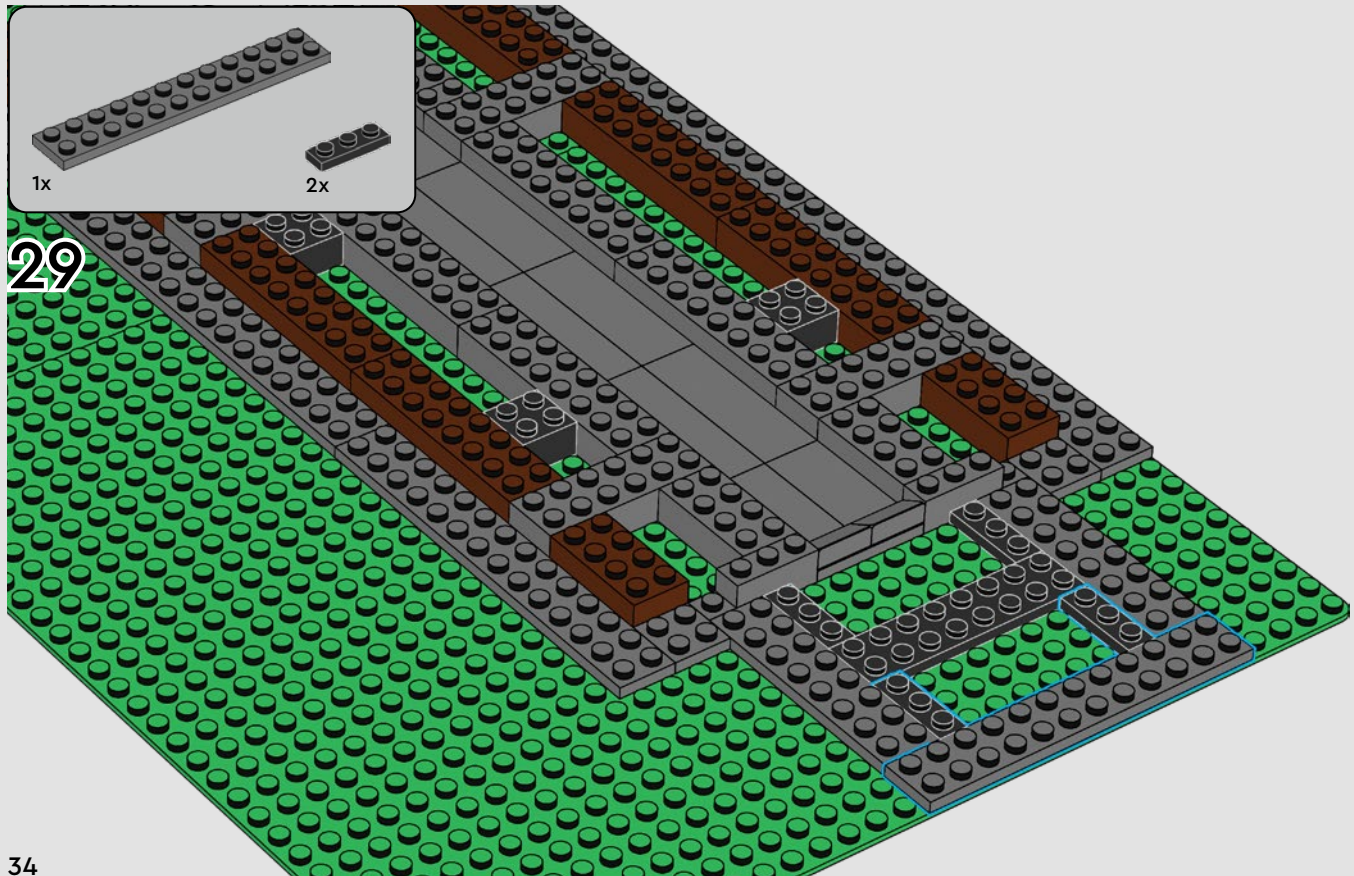

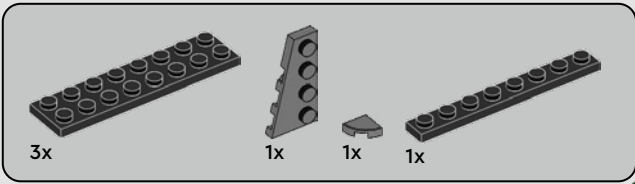

30

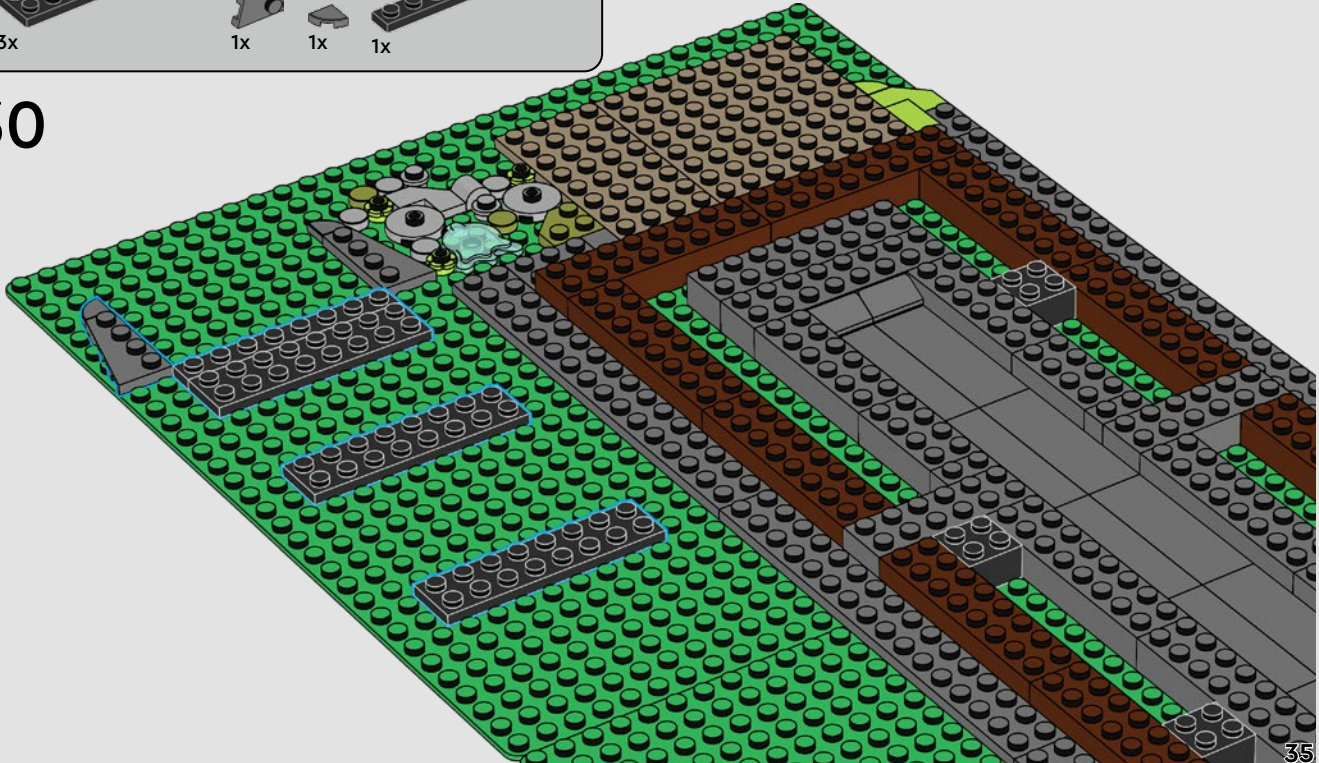

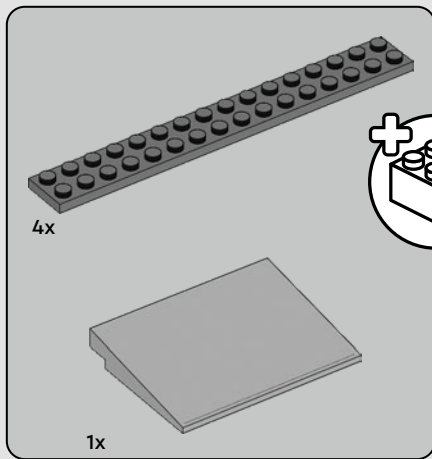

31

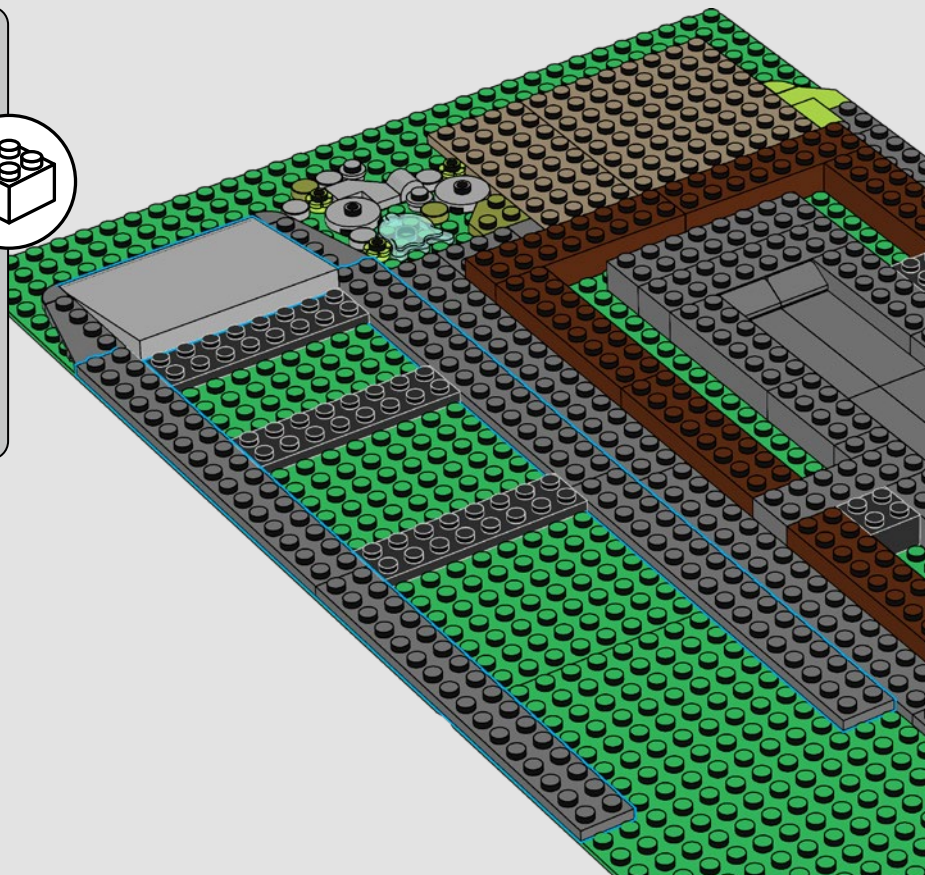

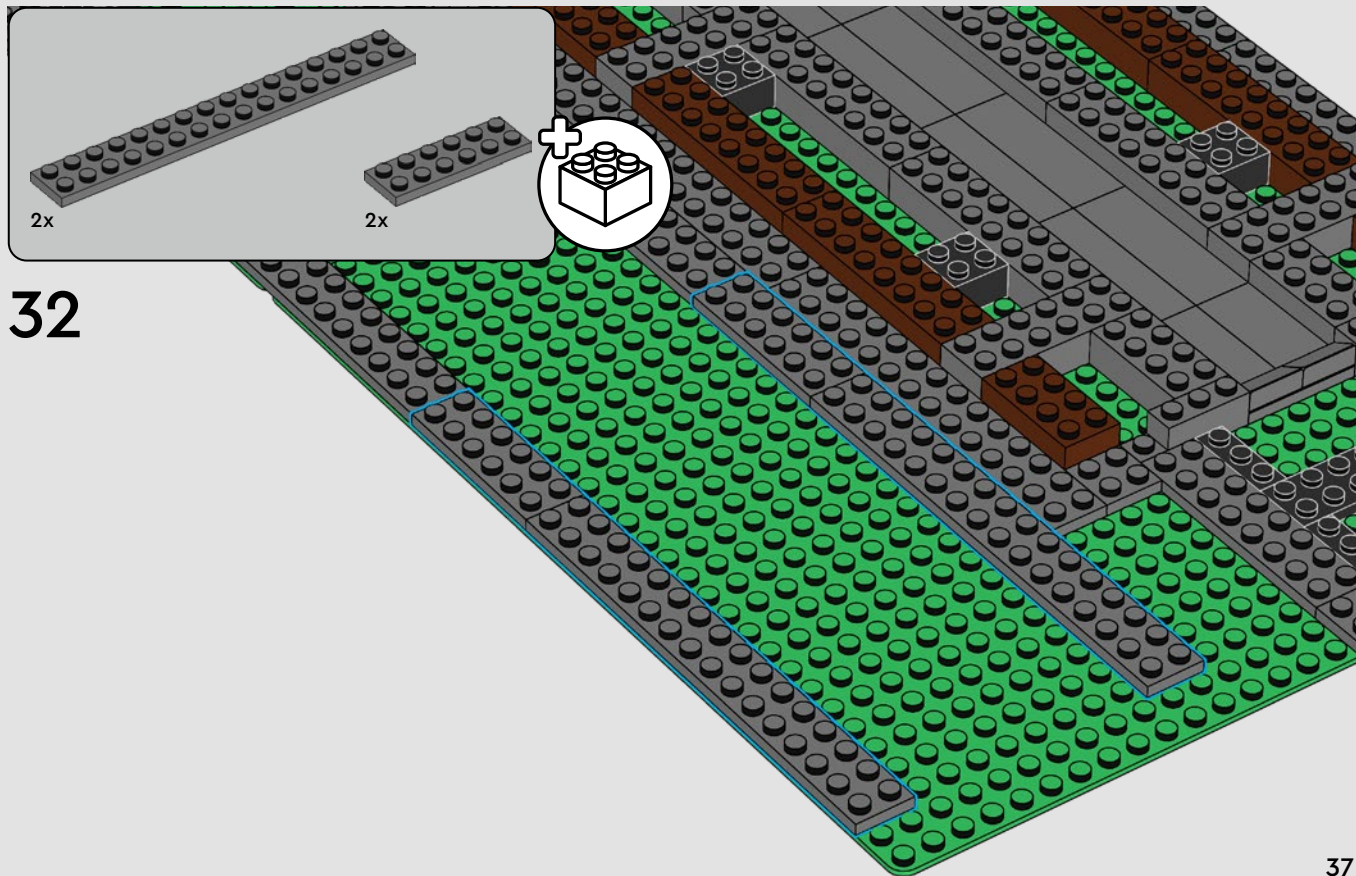

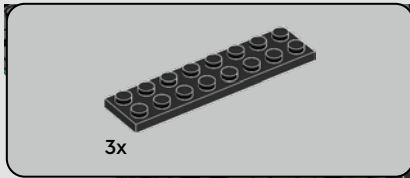



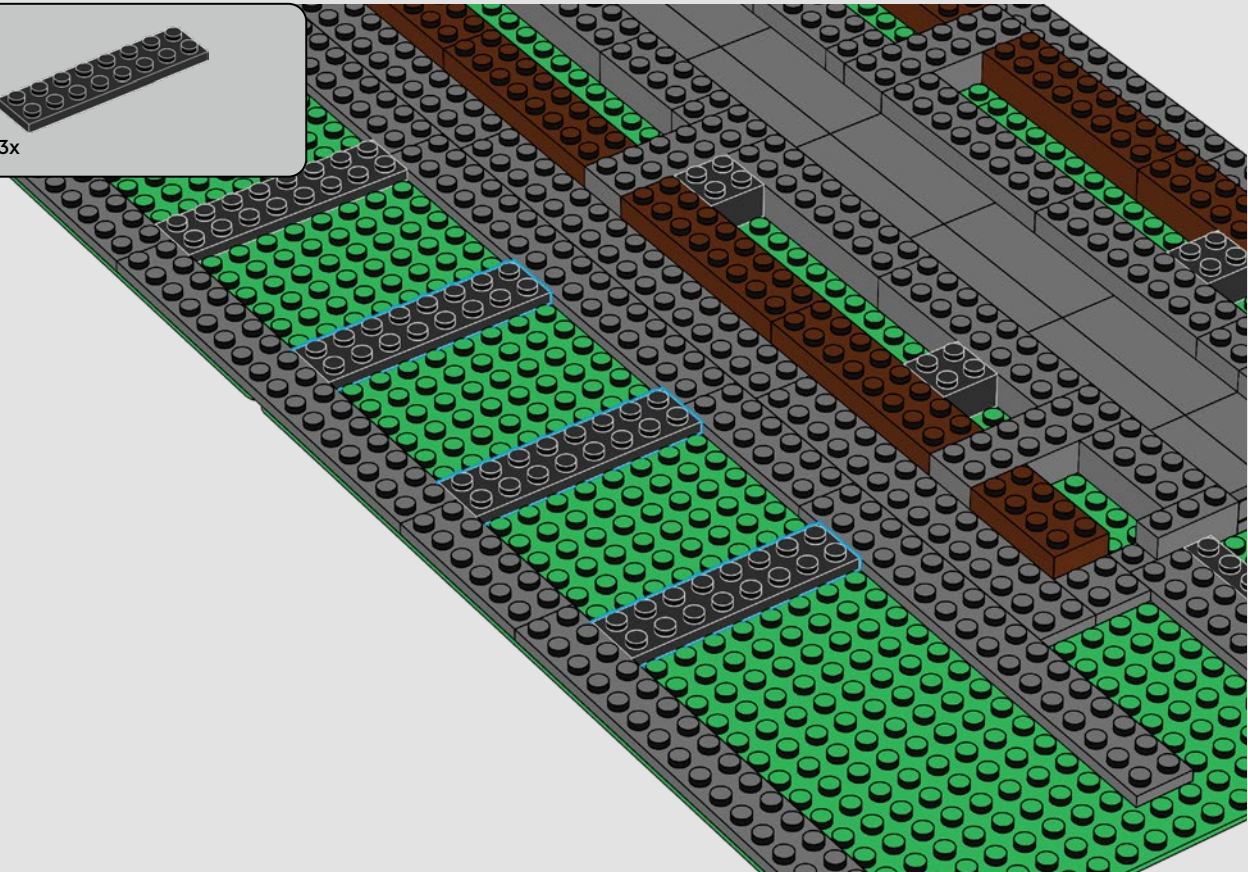

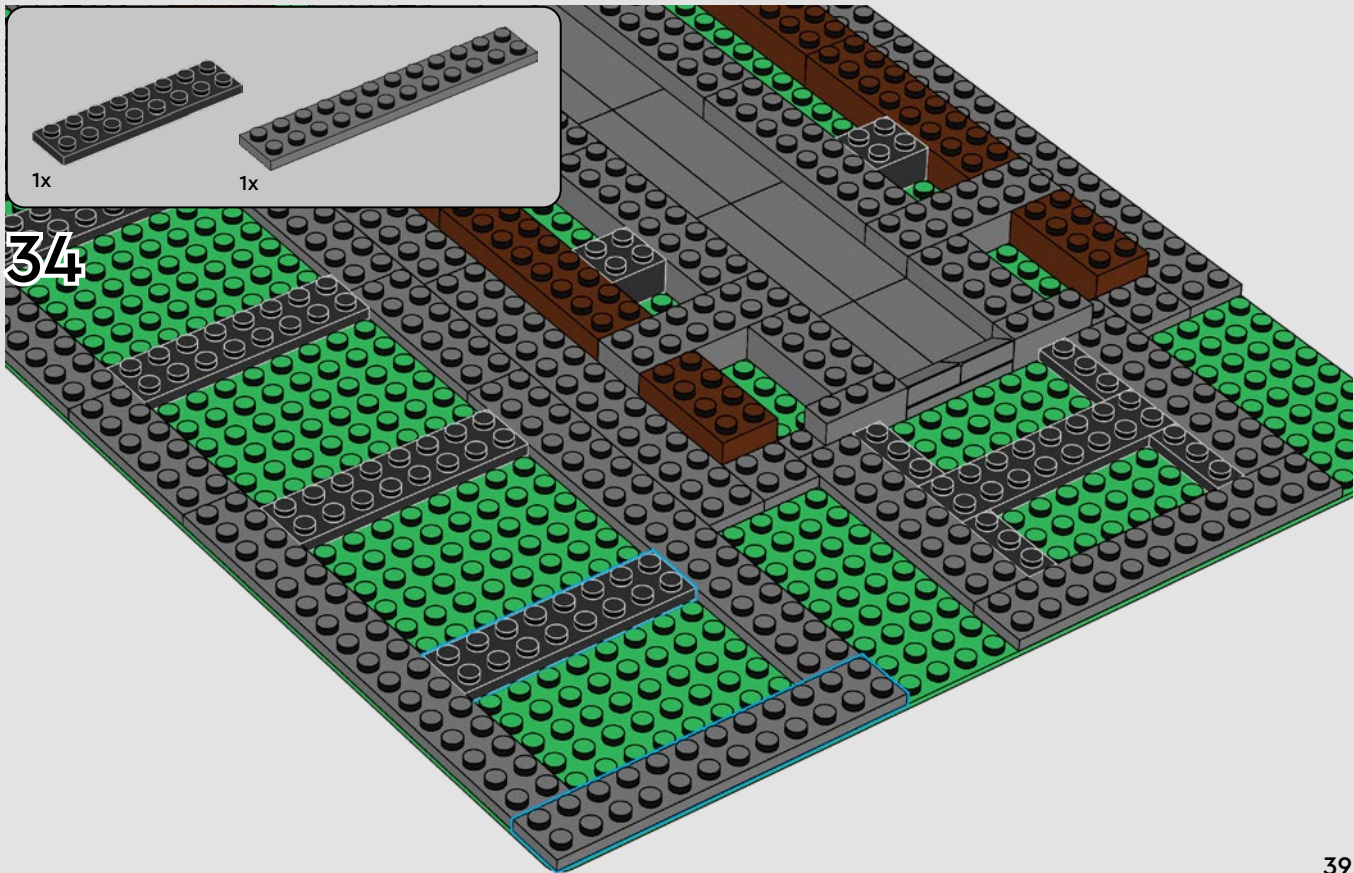
33

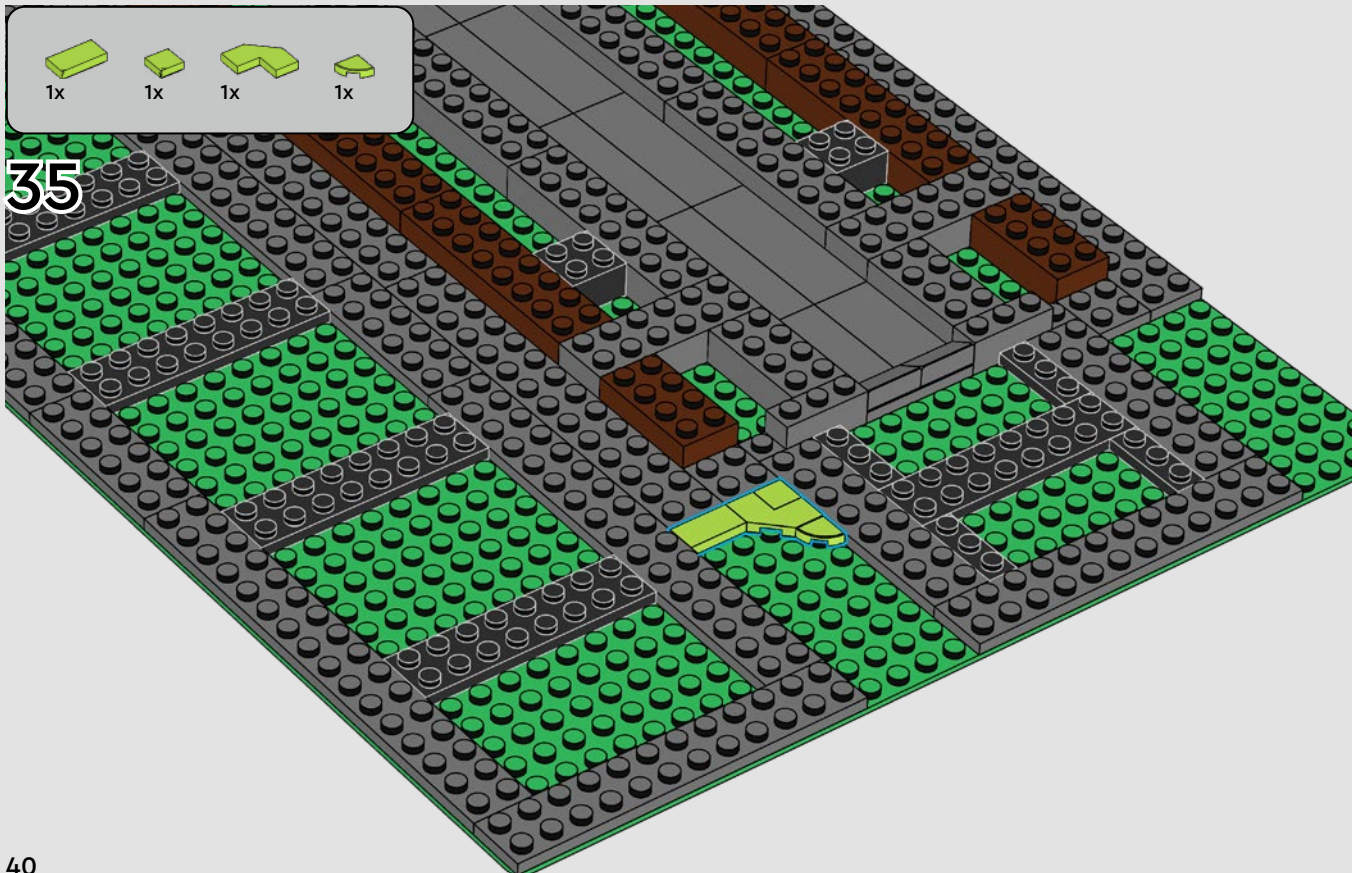





1x  1x  1x  2x 

36

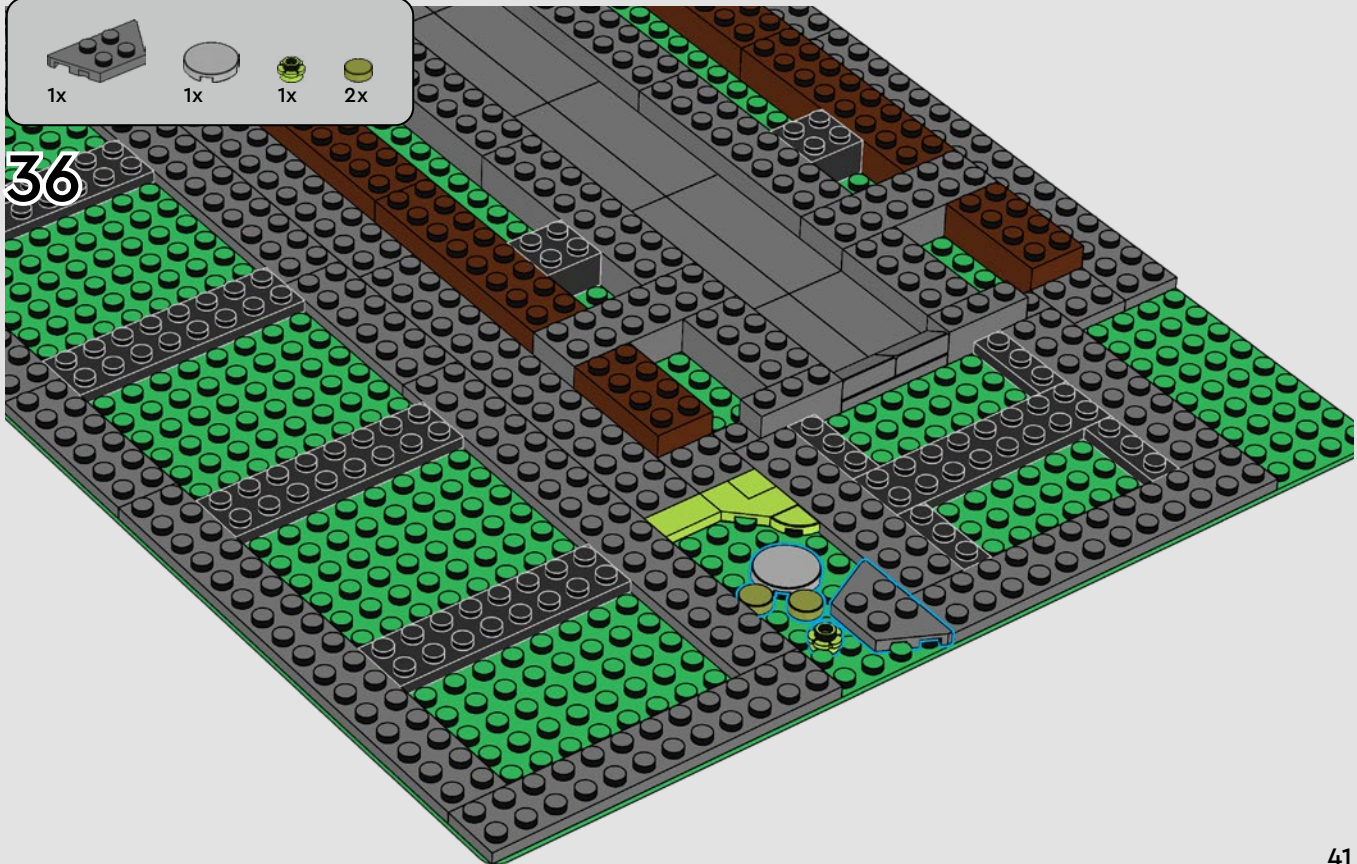

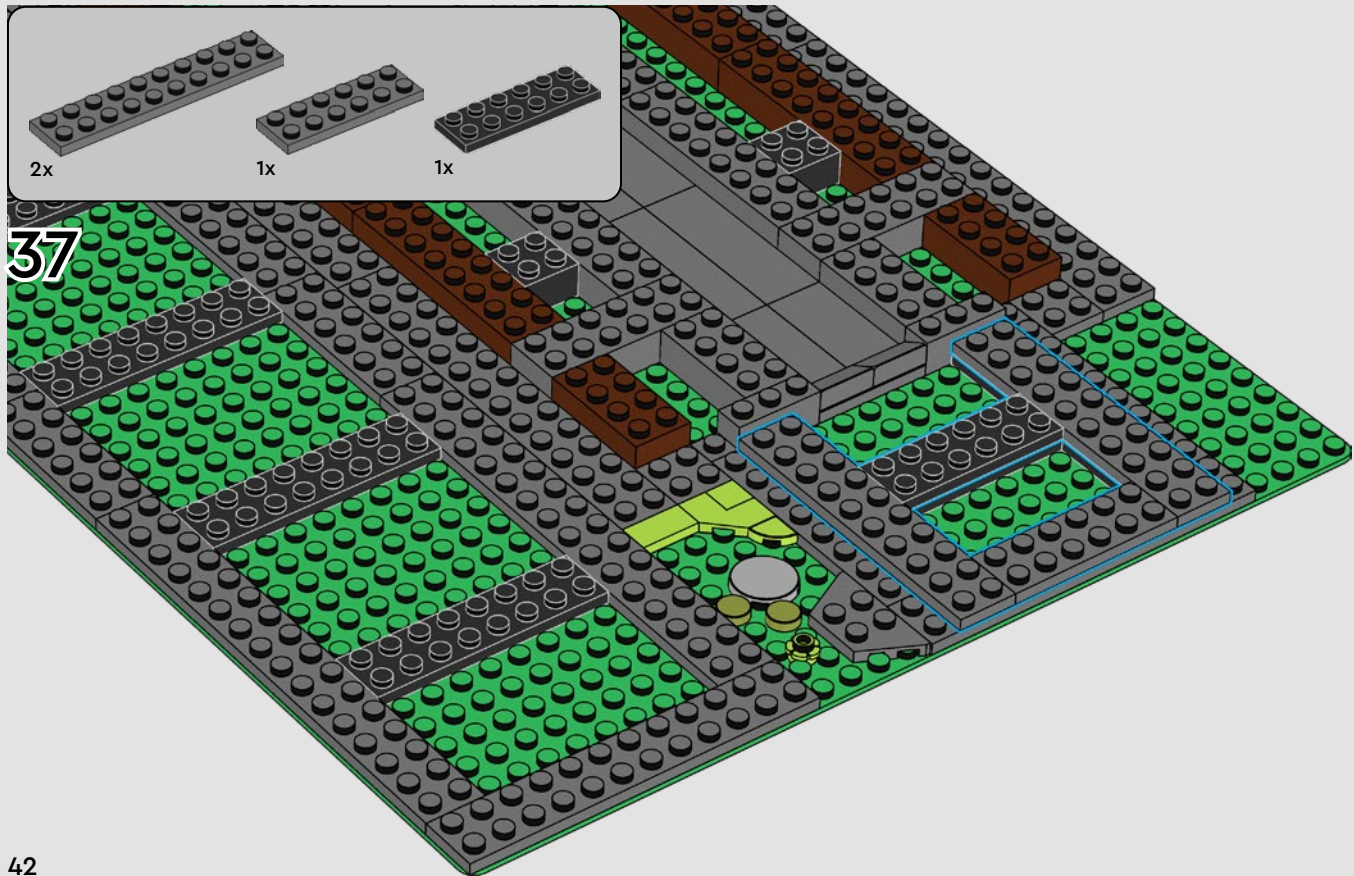

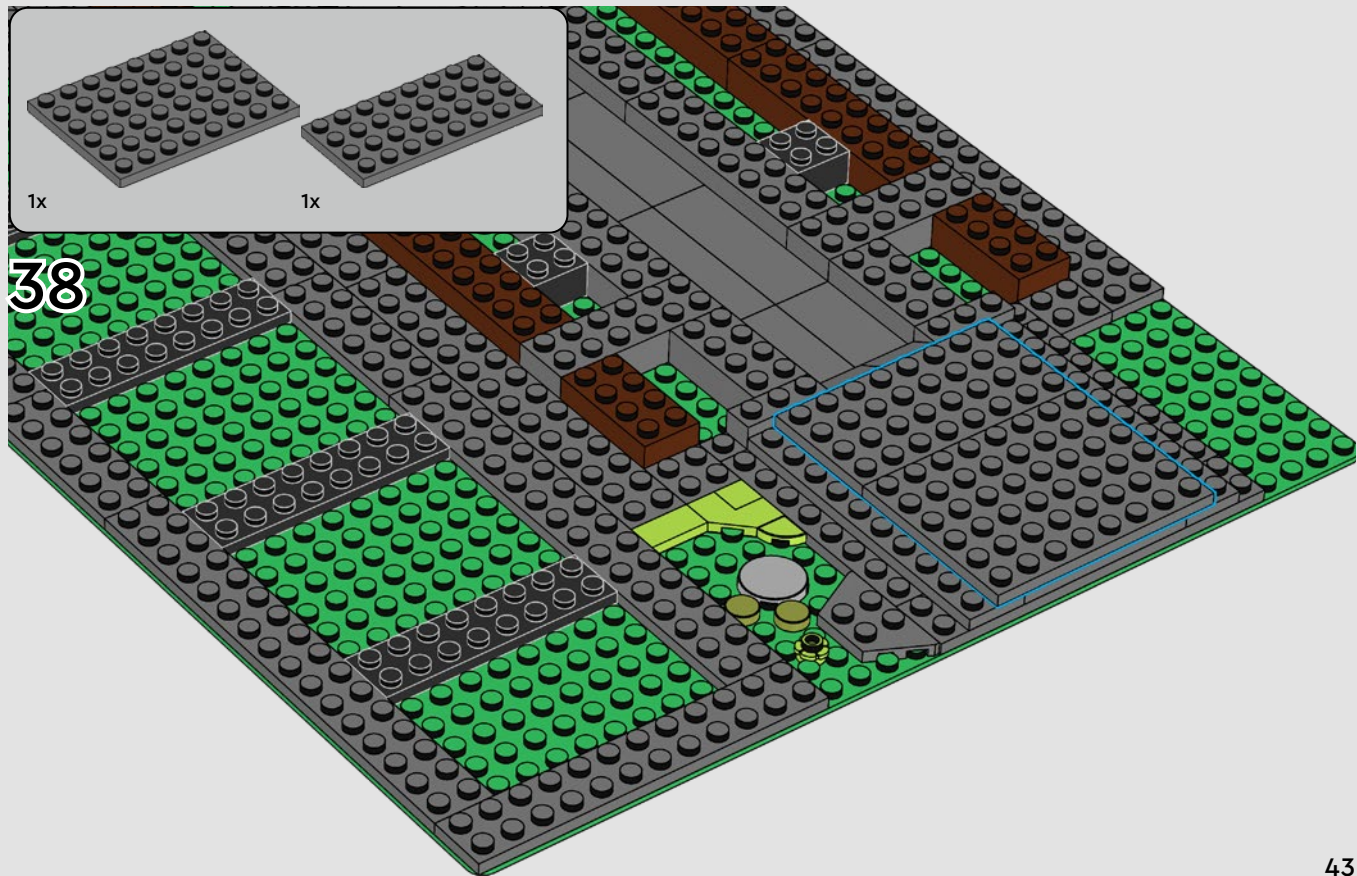

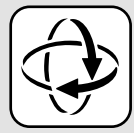
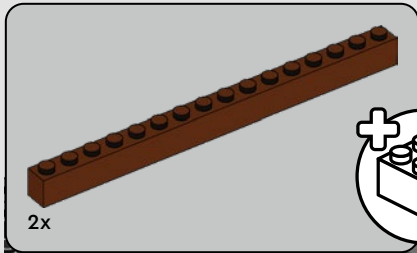

39

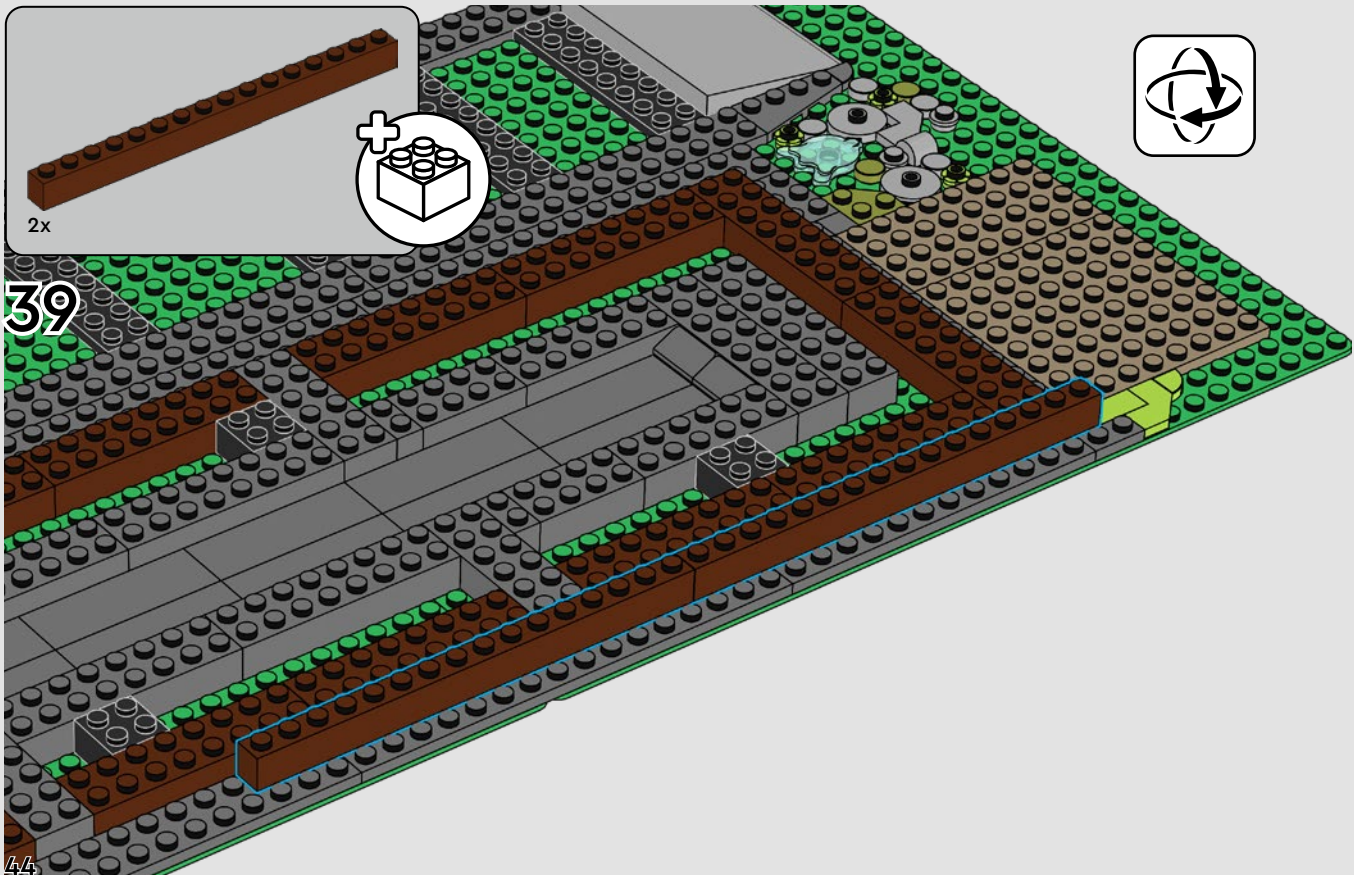

44

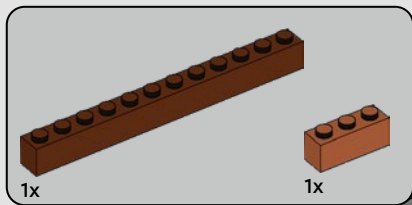

40

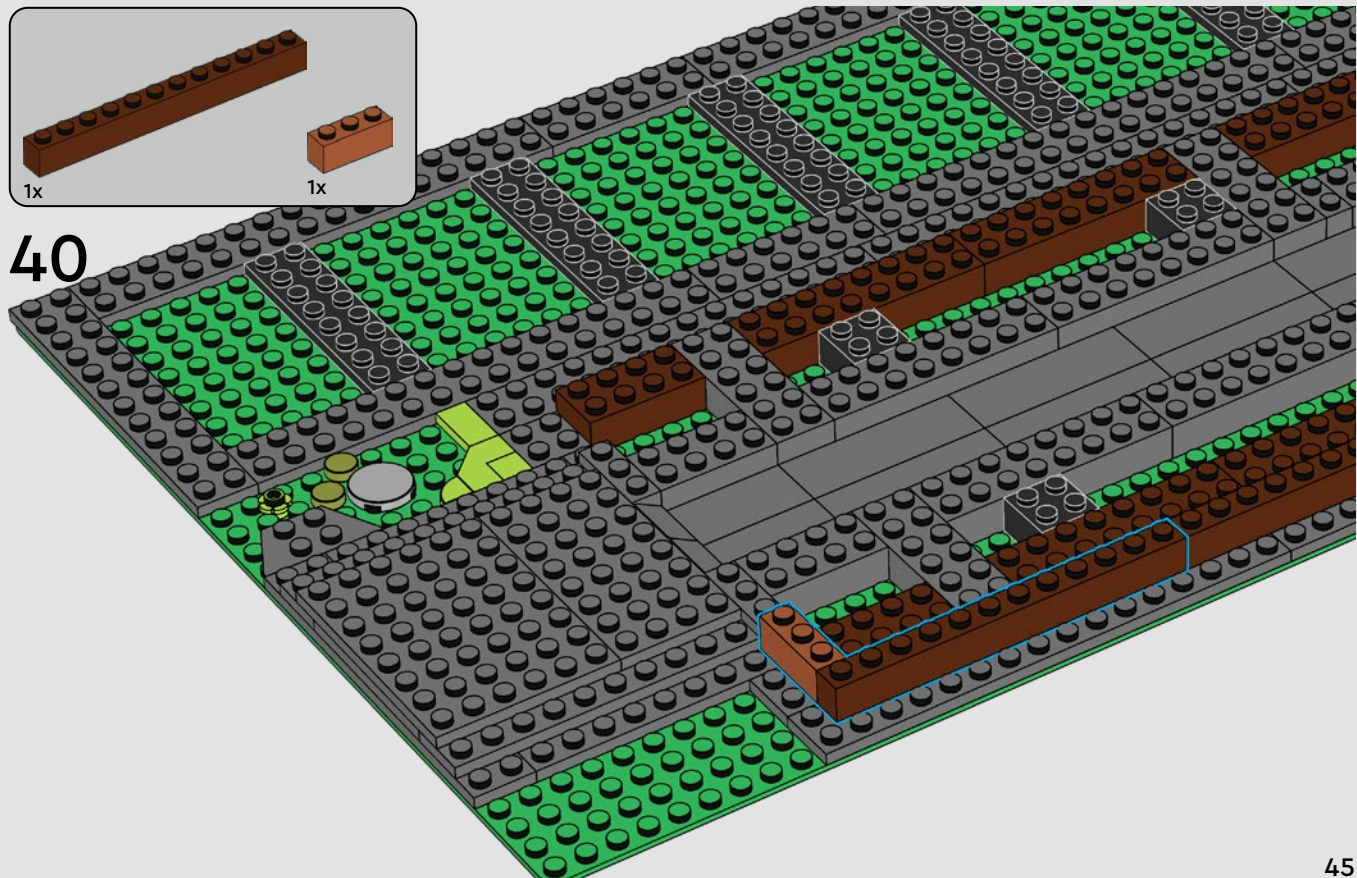



1x

41

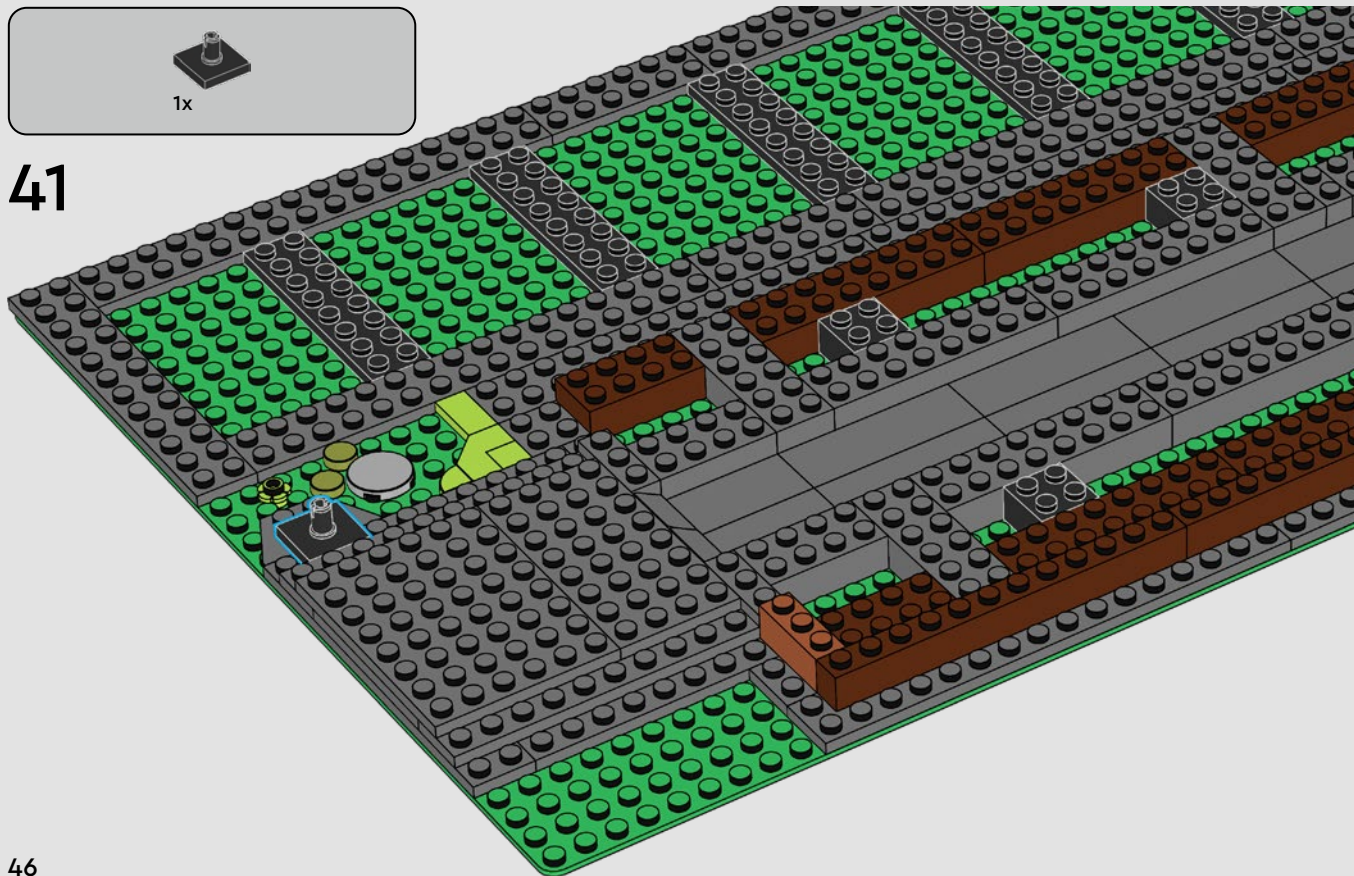

46

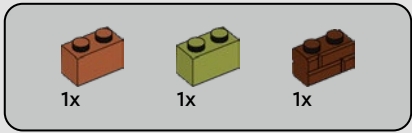

42

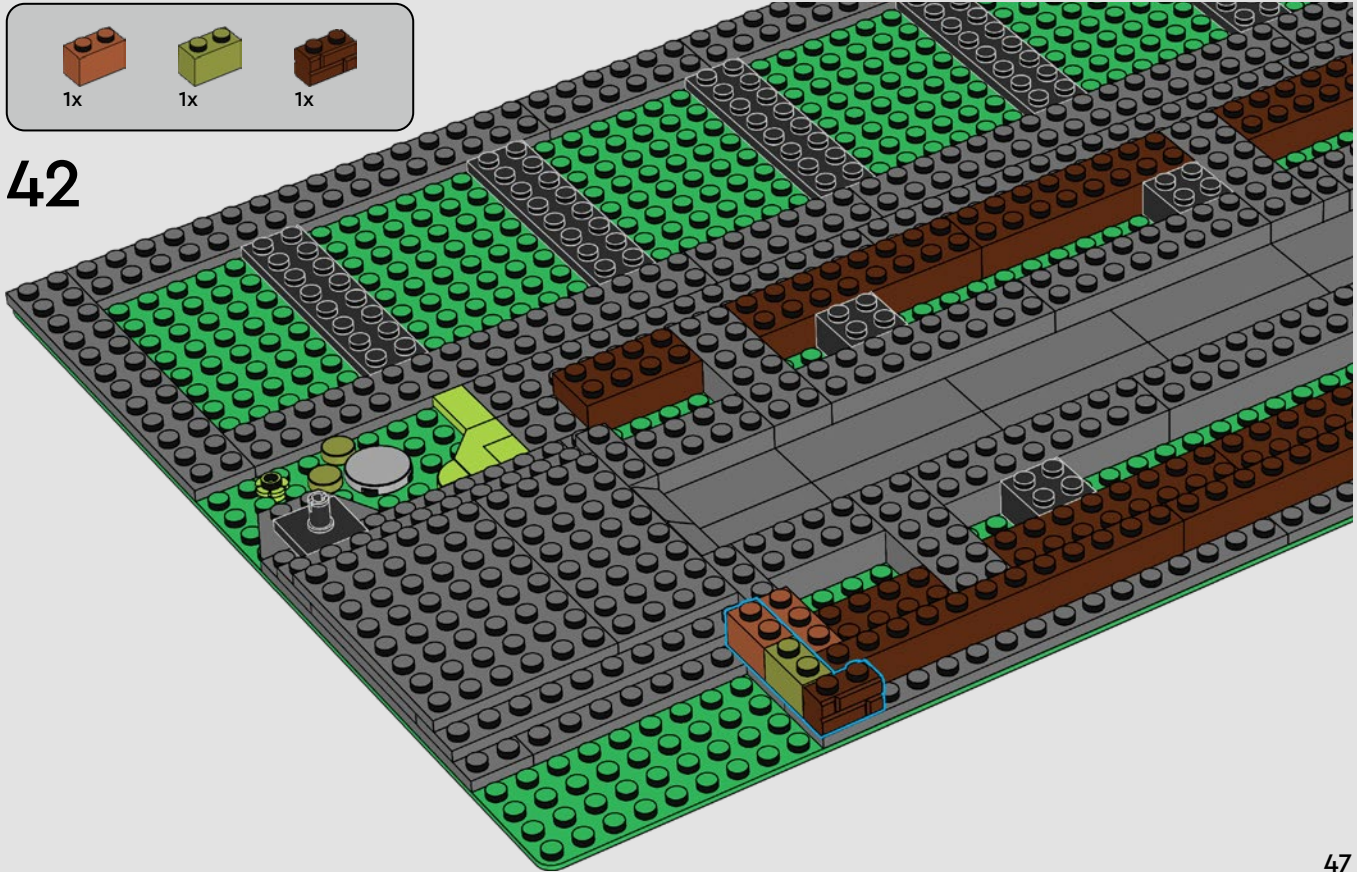

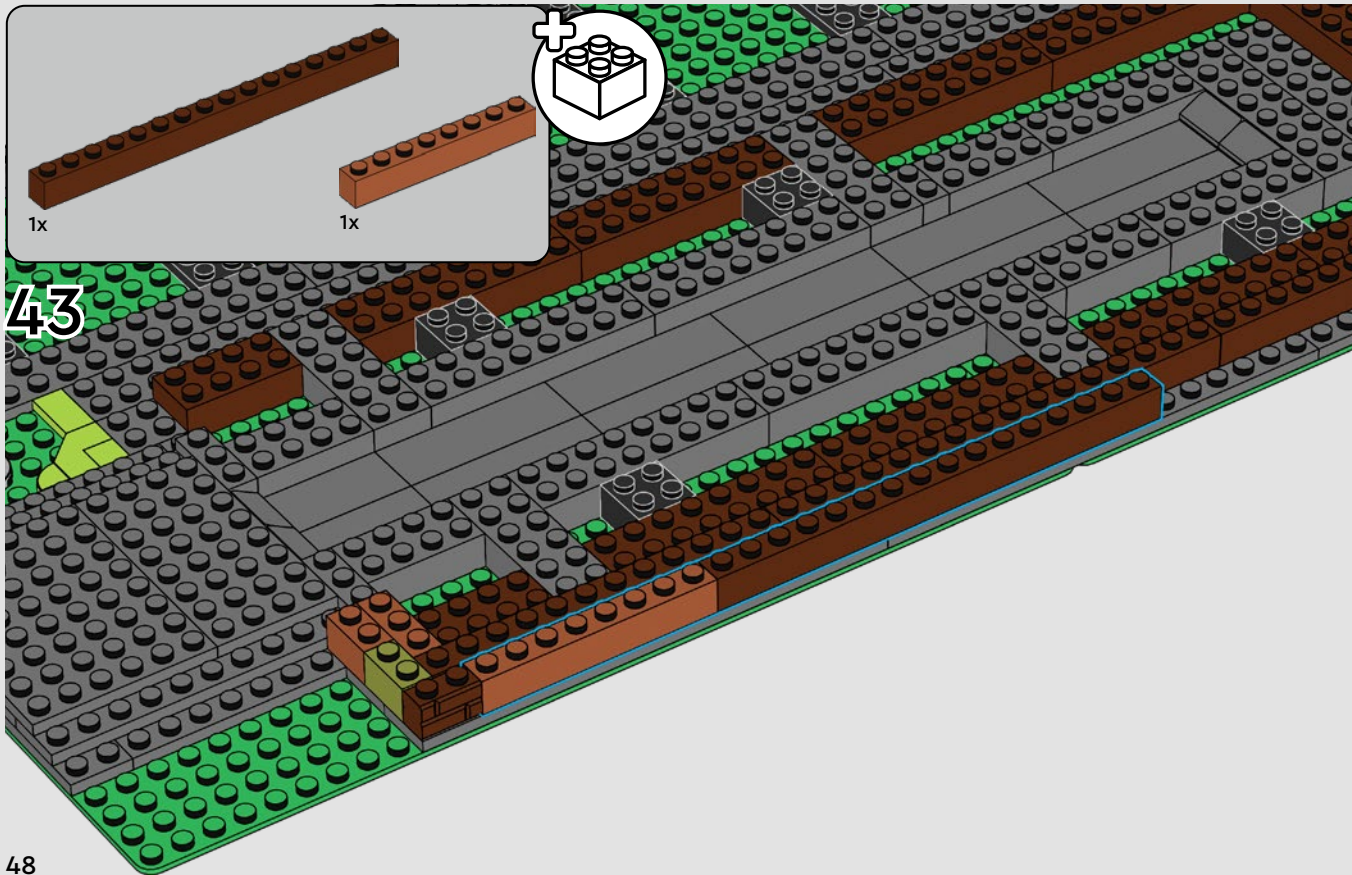

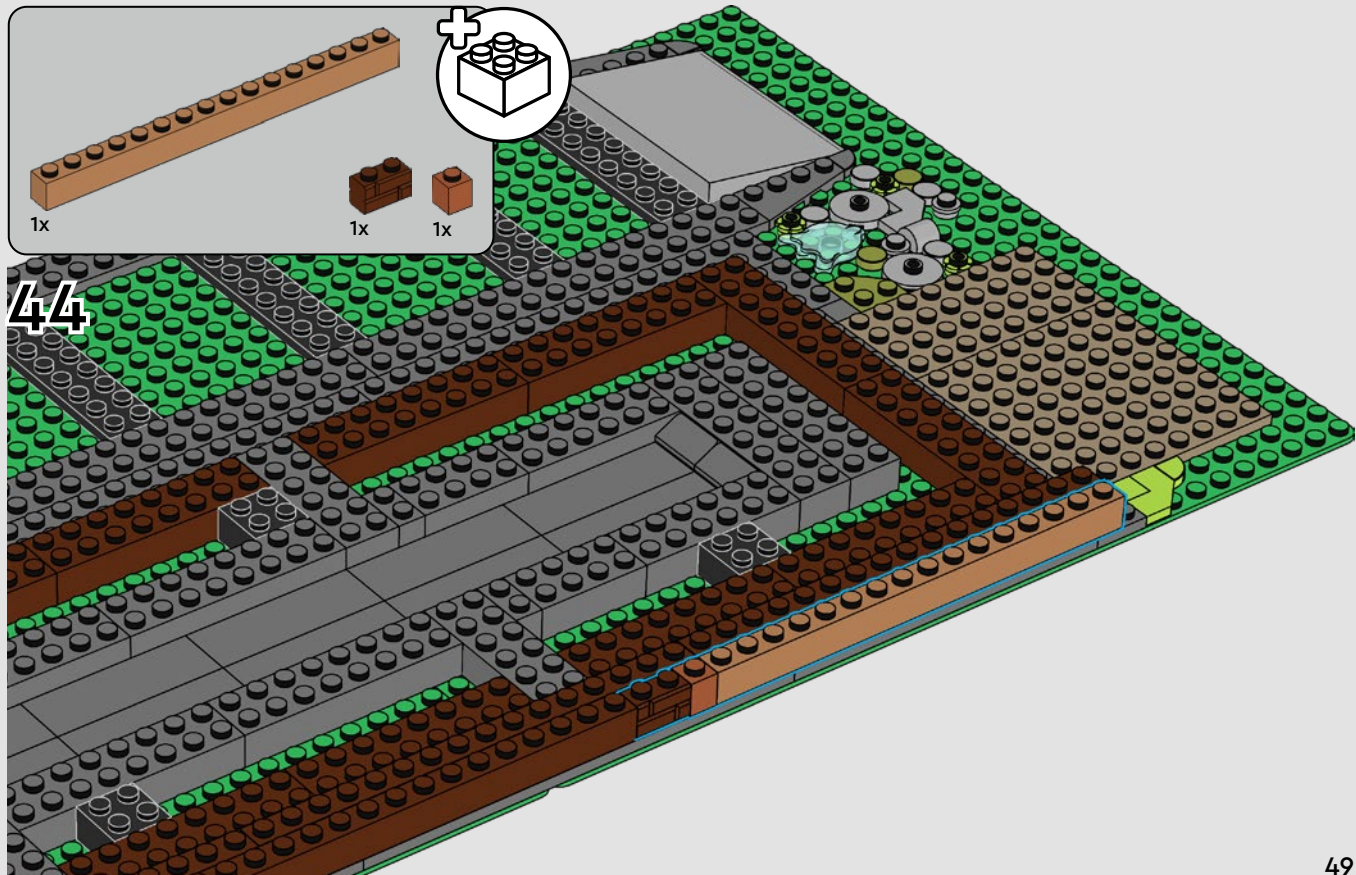

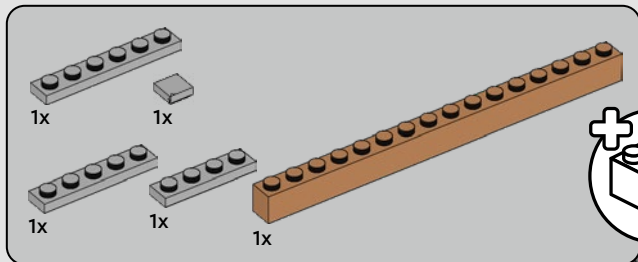

45

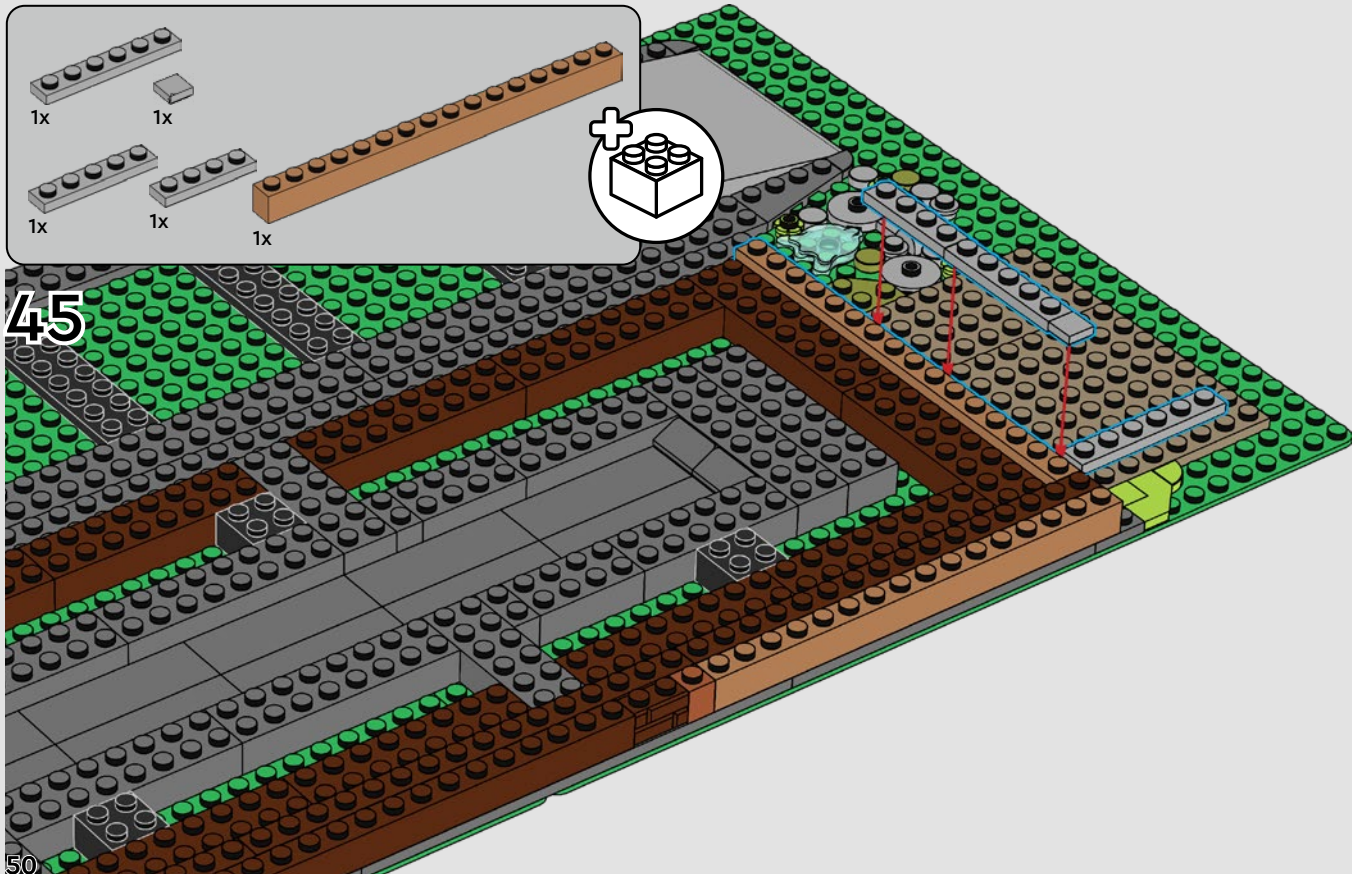

50

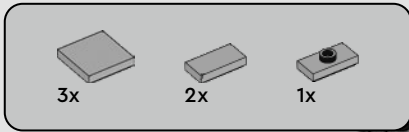

46

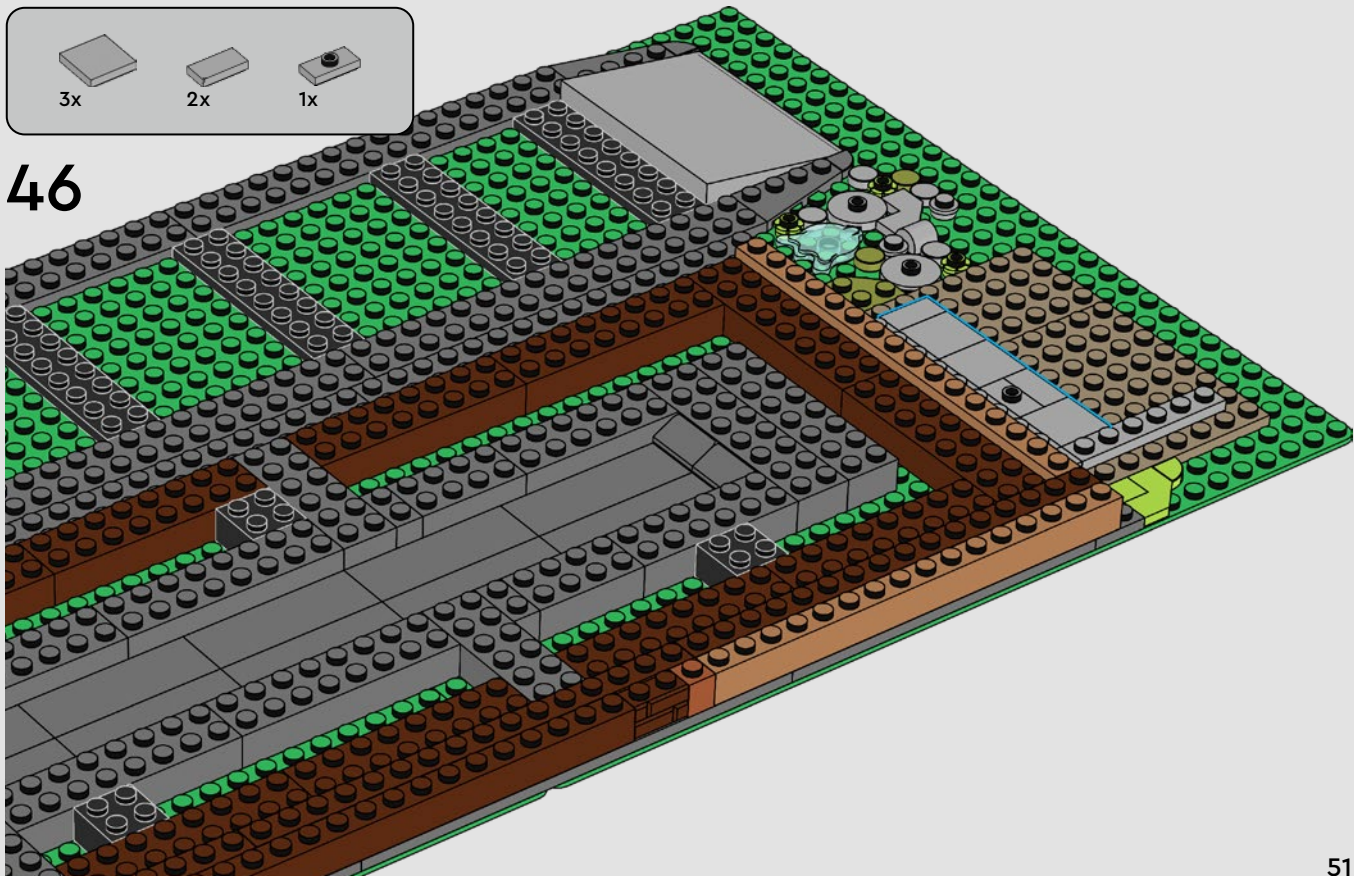

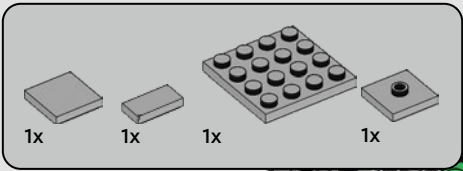

47

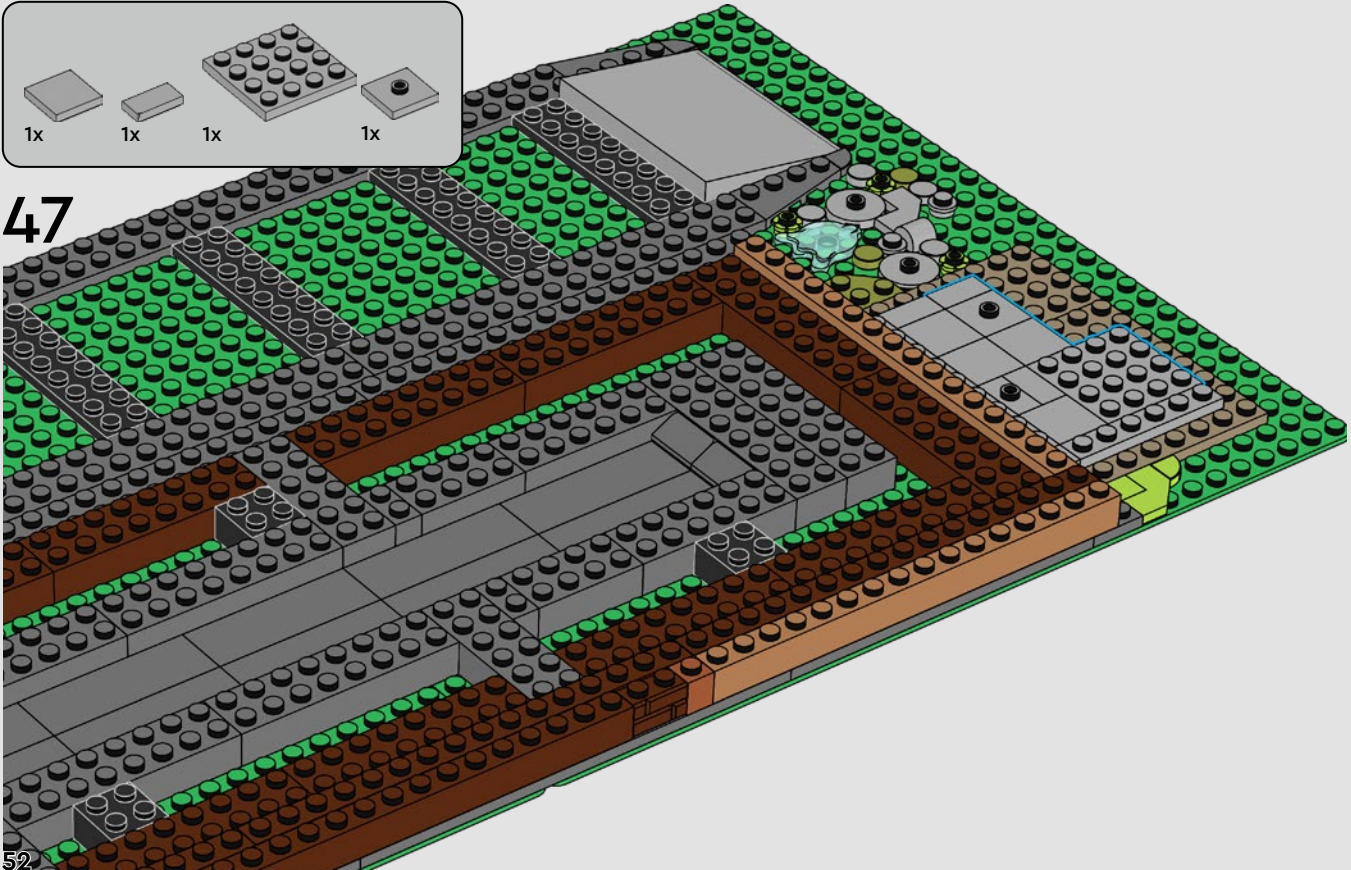

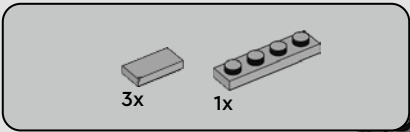

48

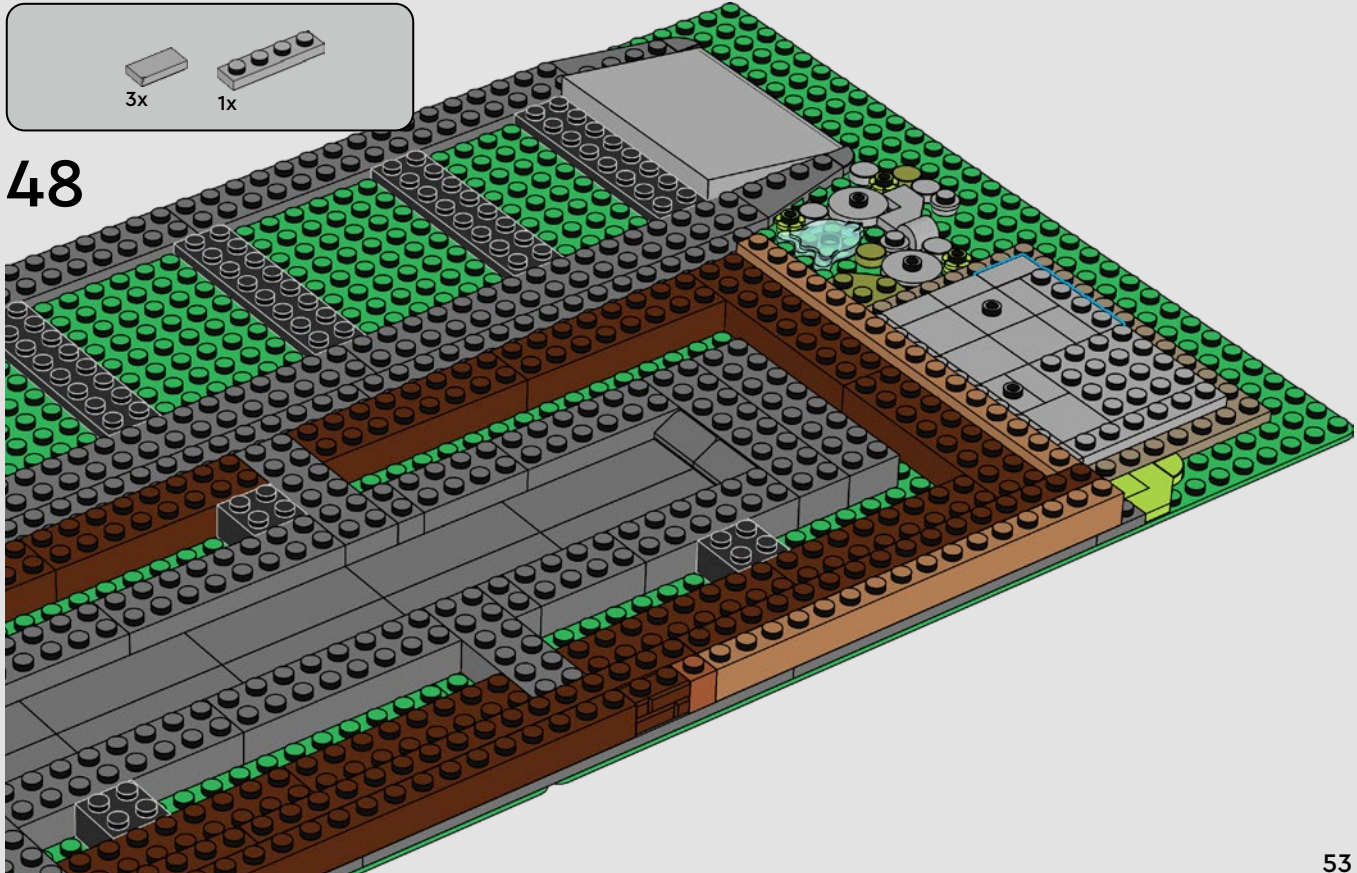

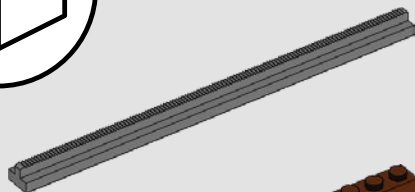
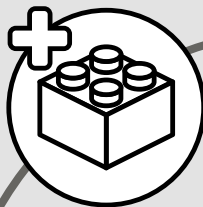

6x

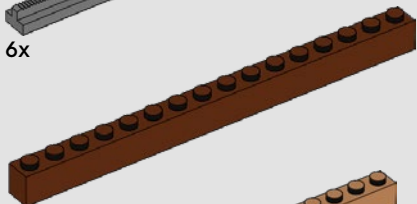

3x

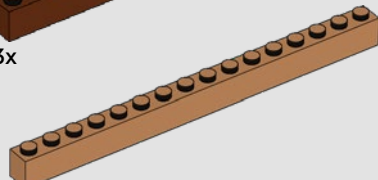

1x

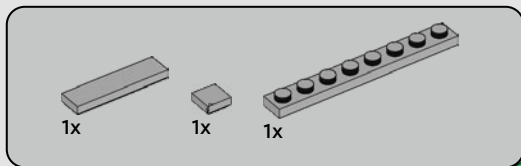

49

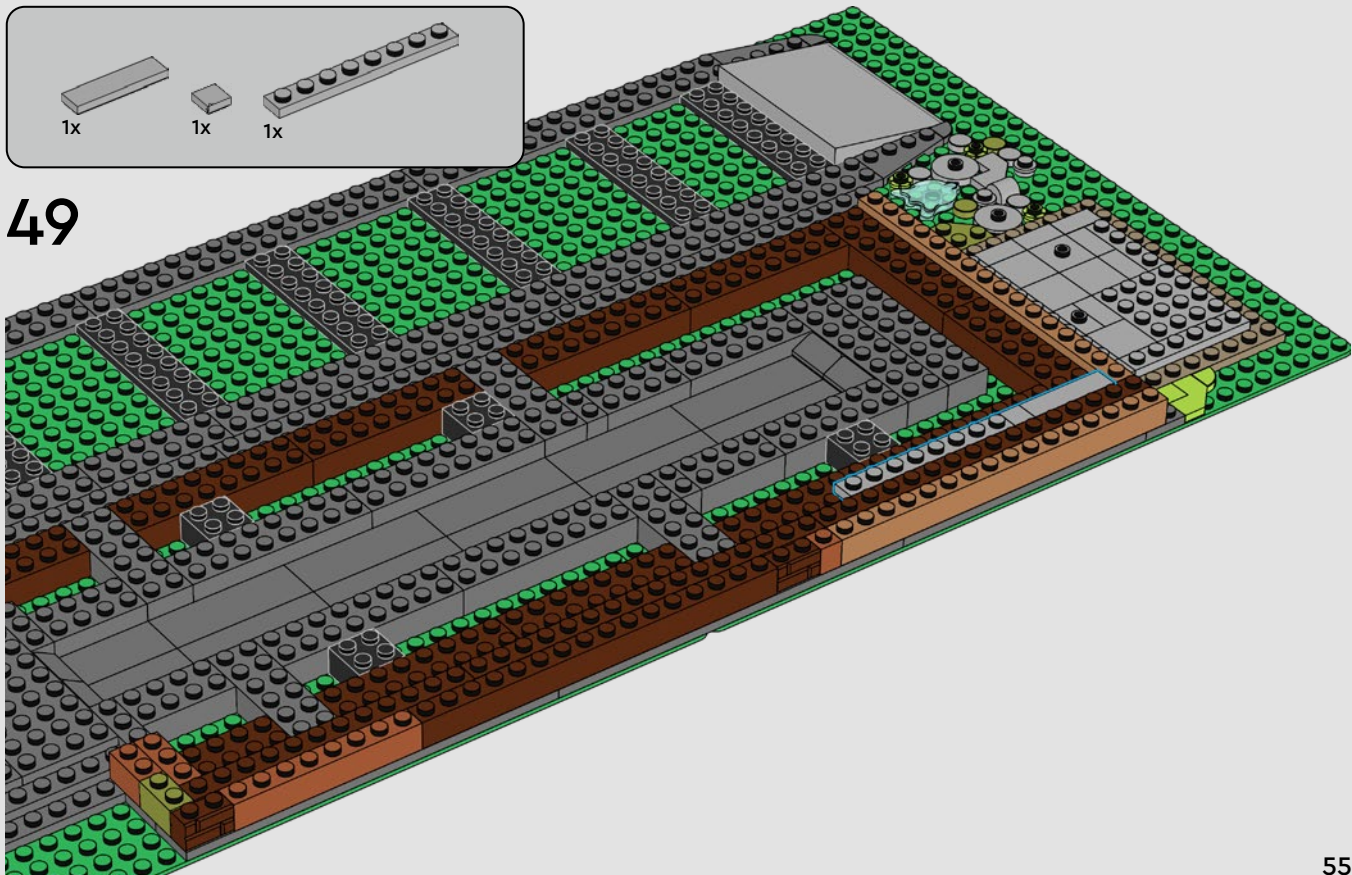

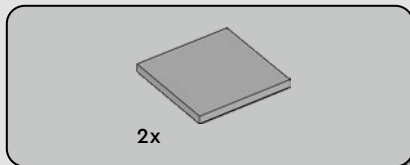

50

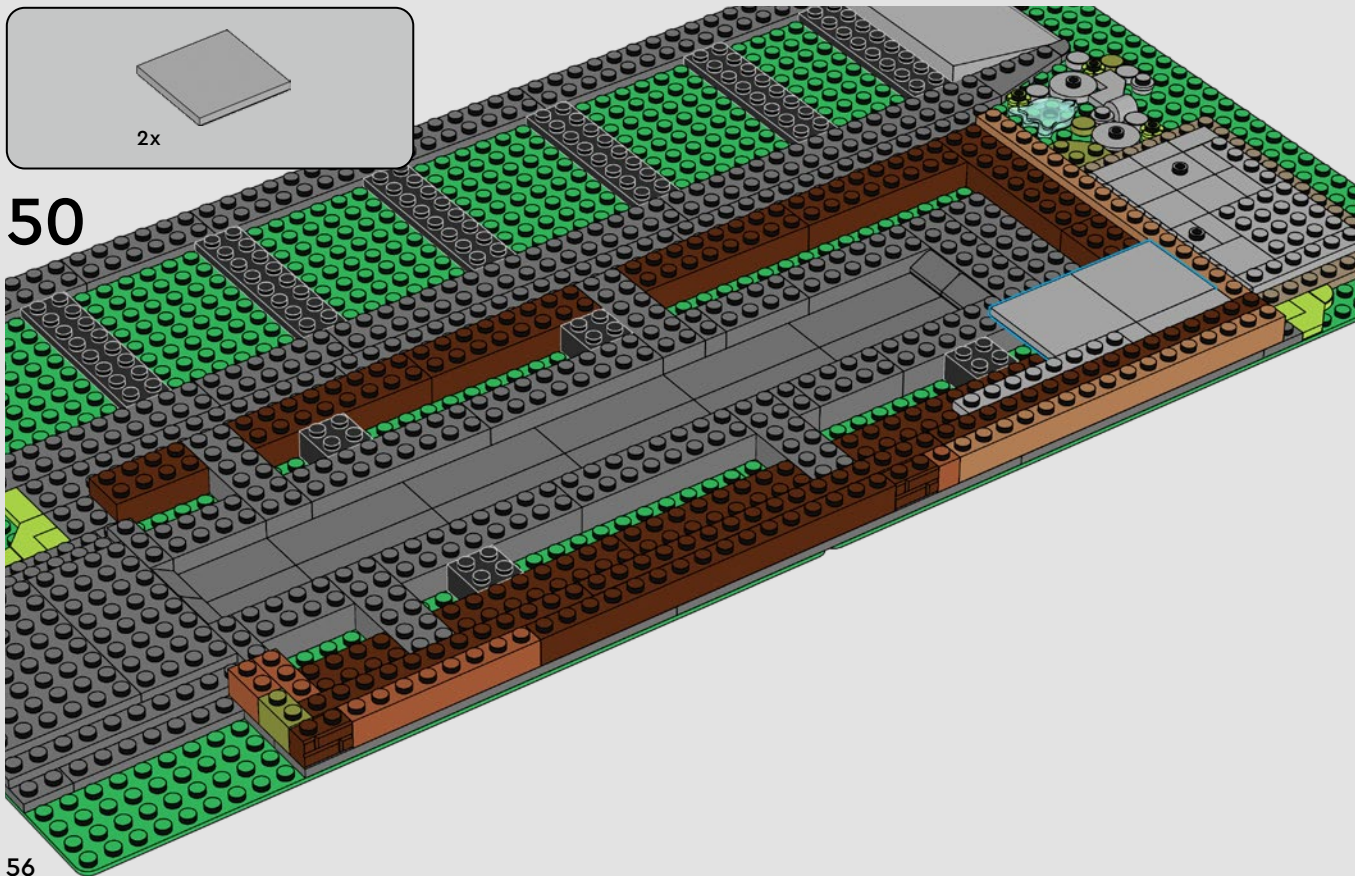

56

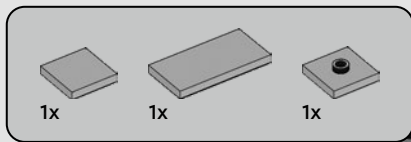

51

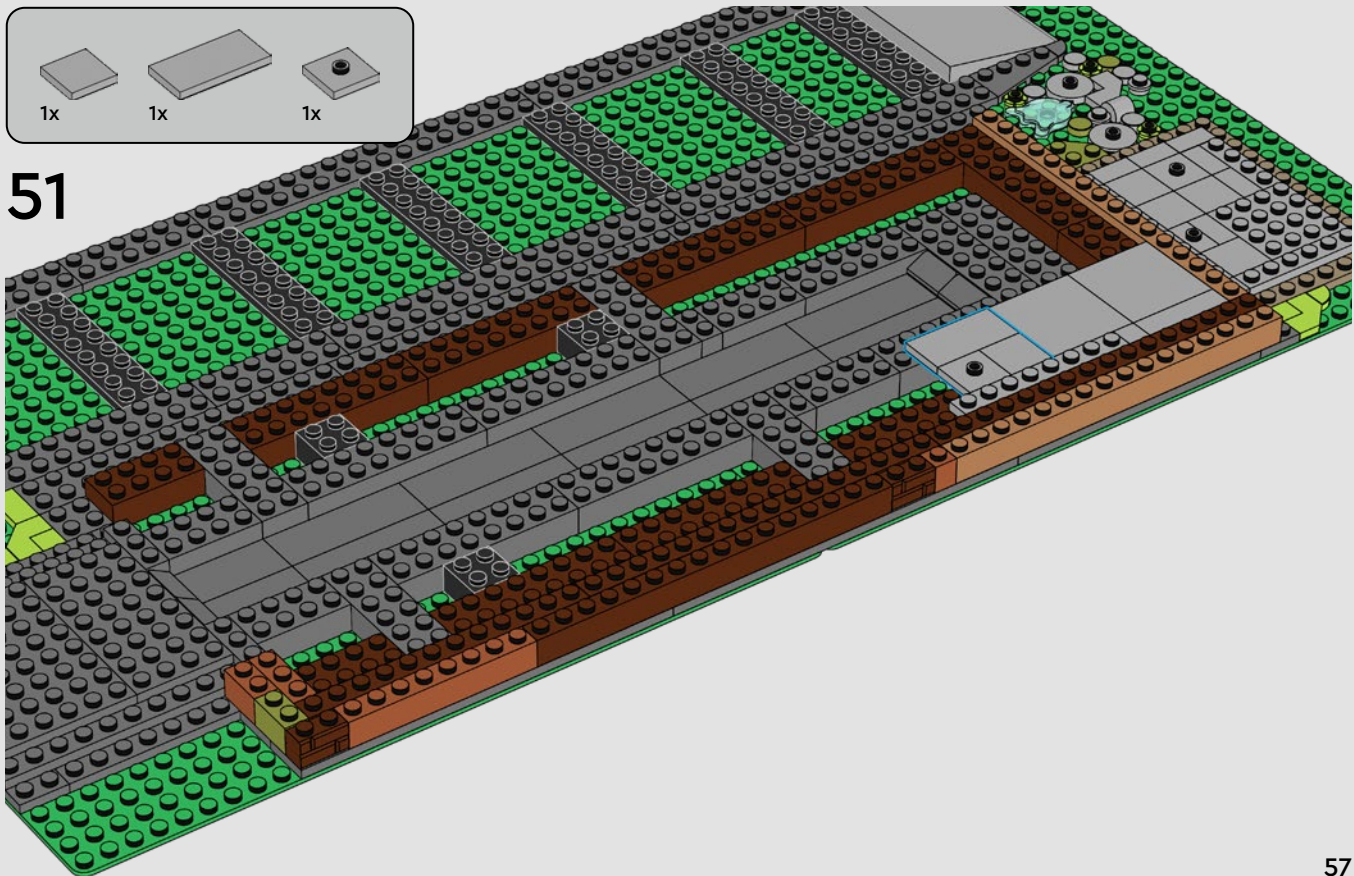

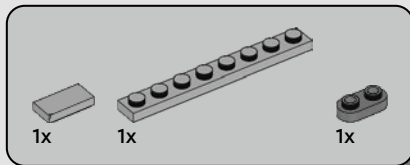

52

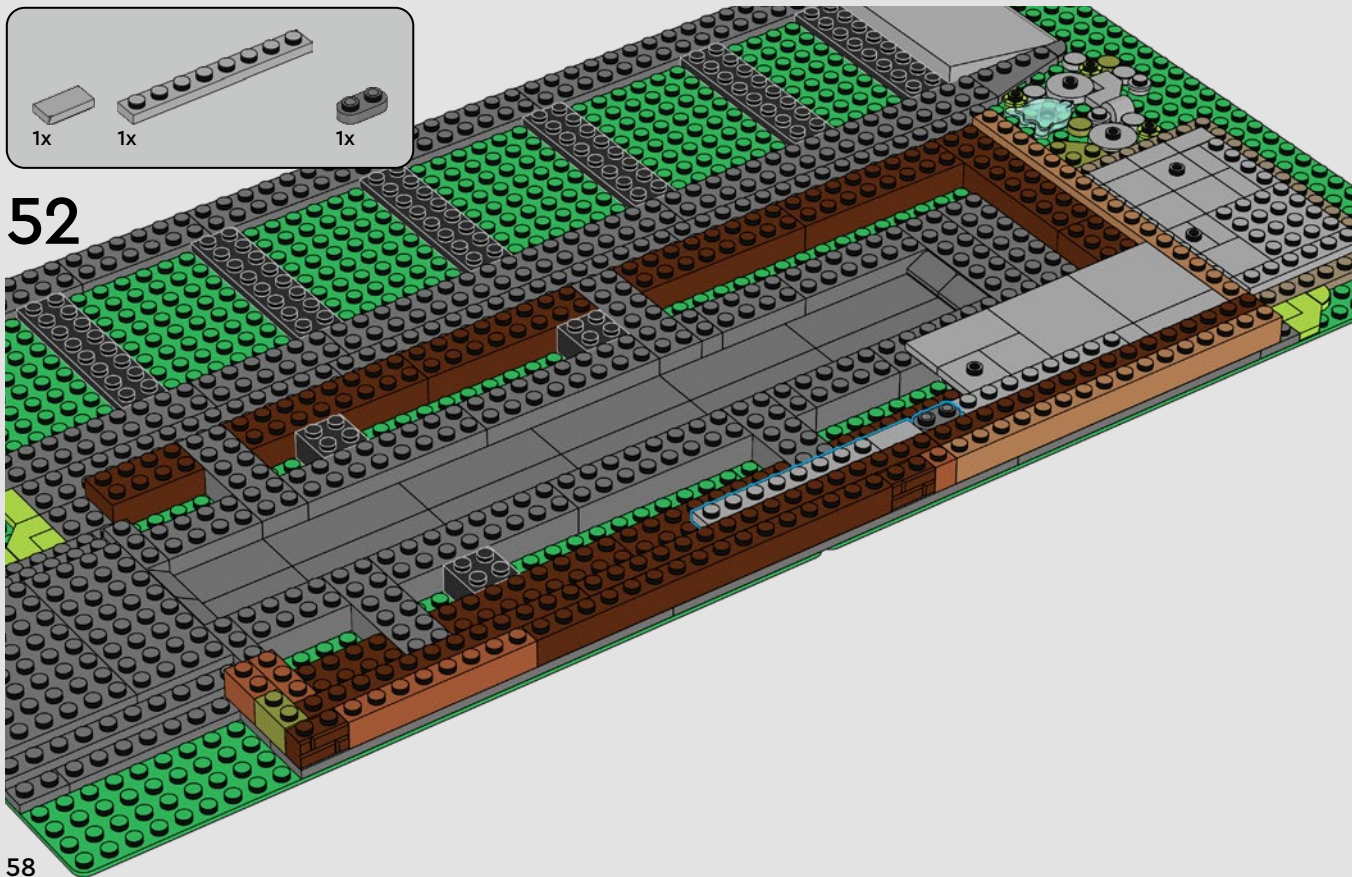

58

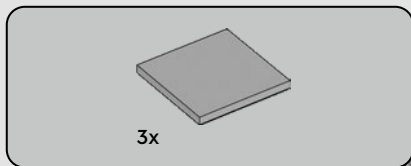

53

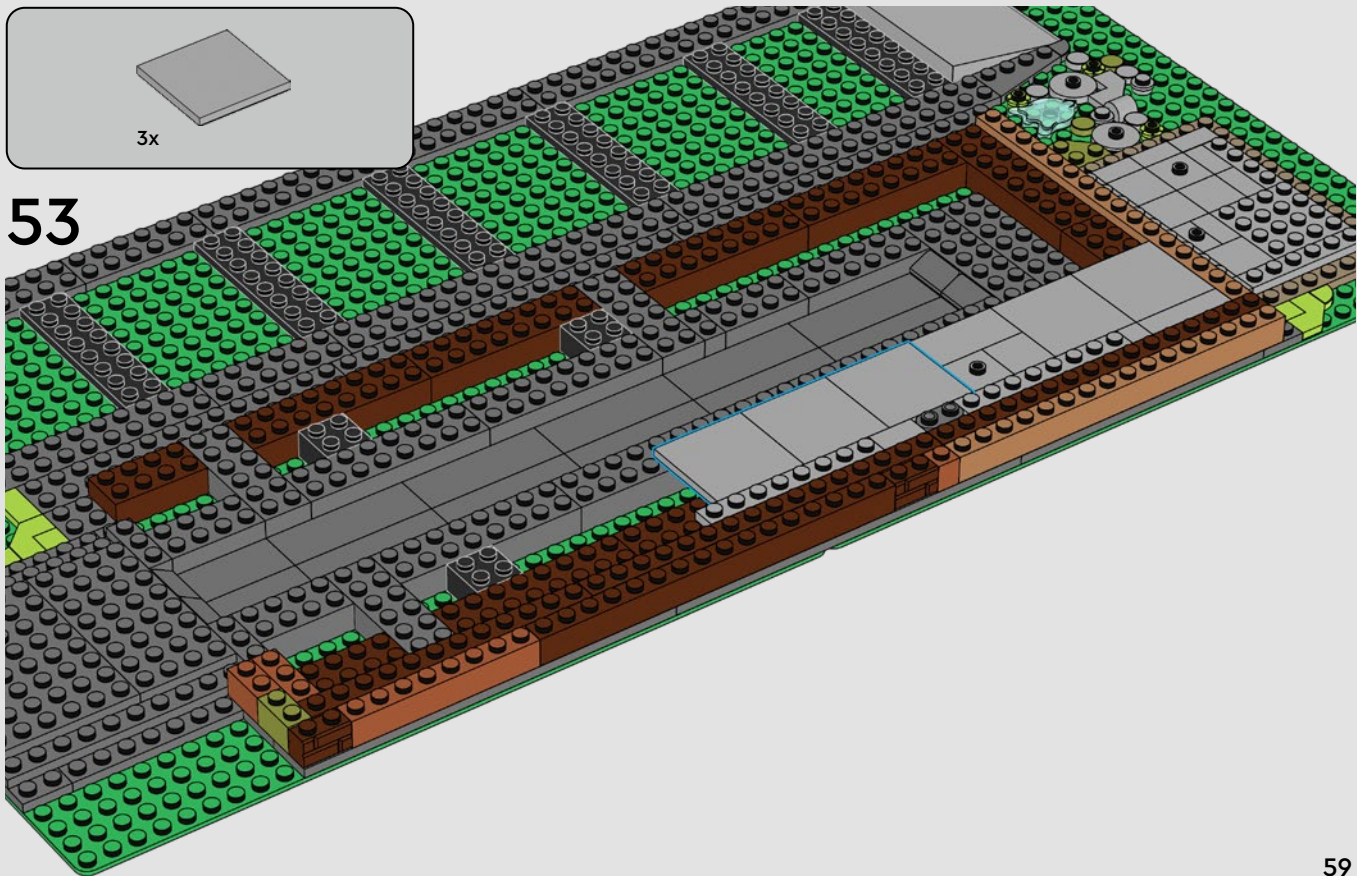

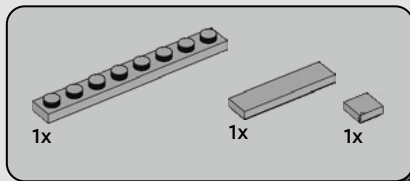

54

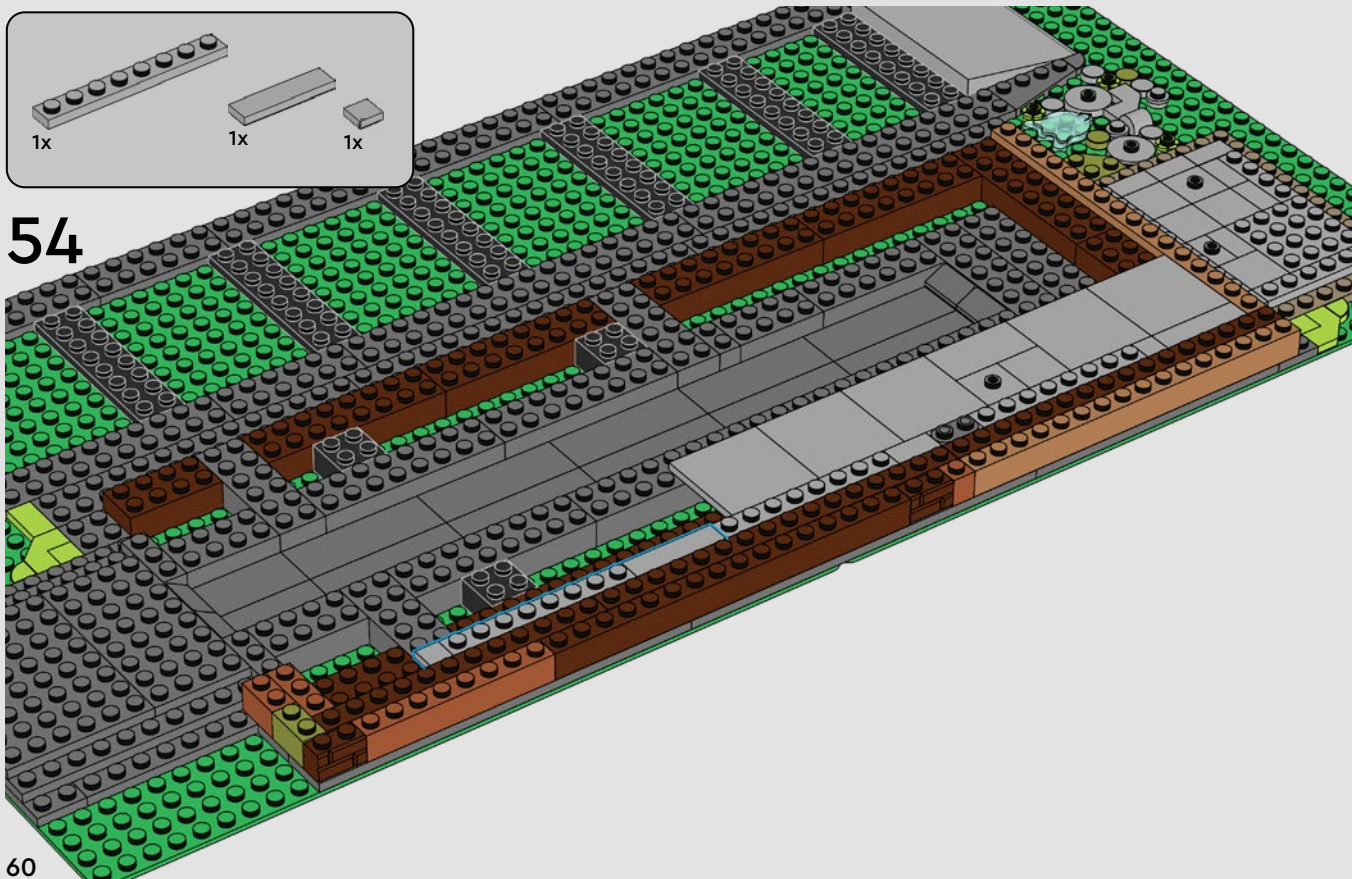

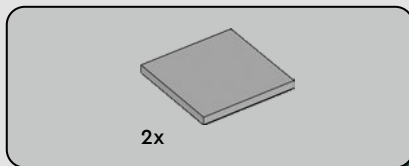

55

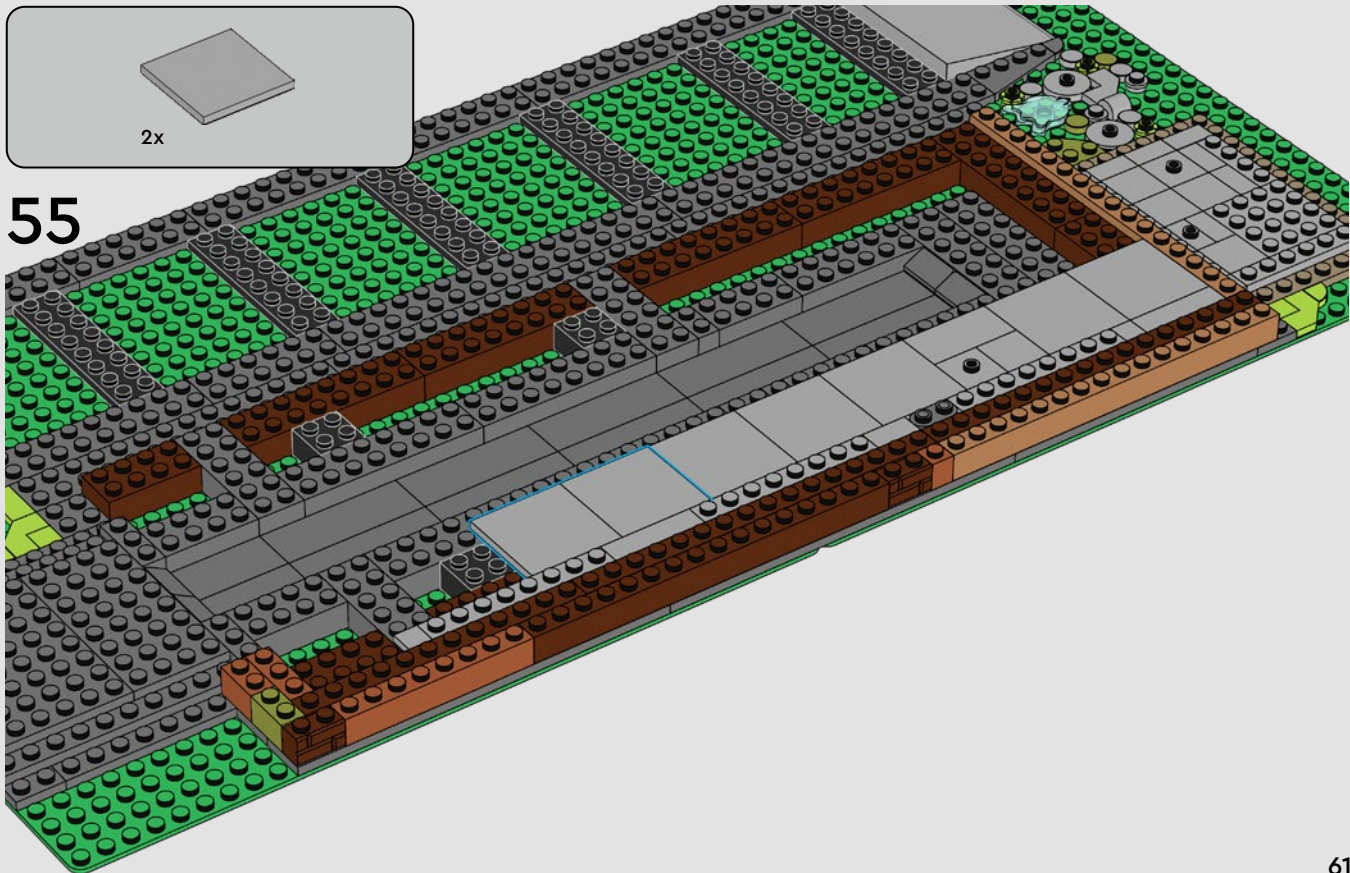

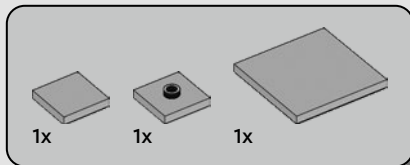

56

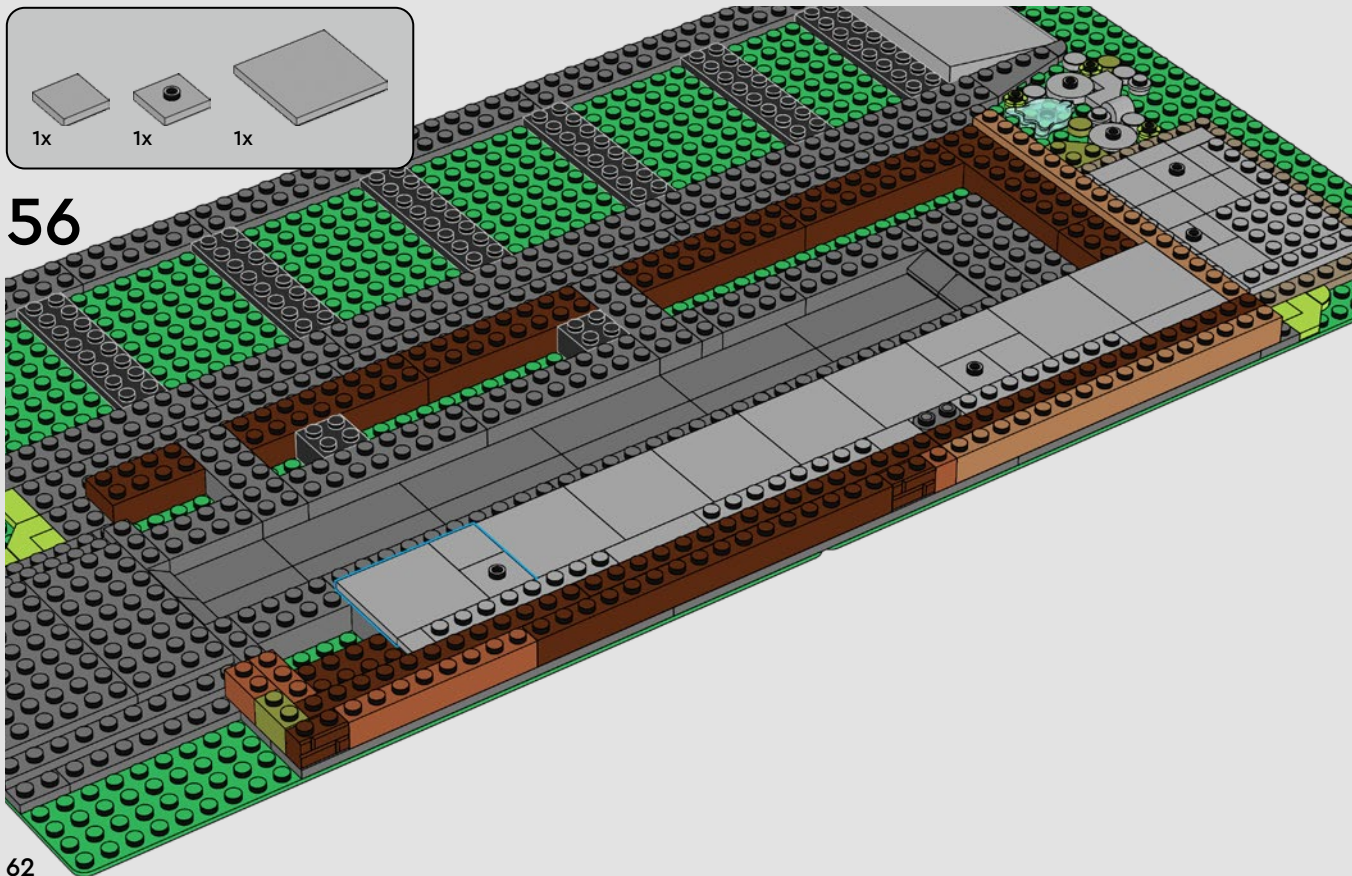

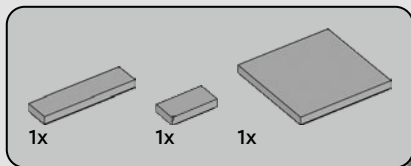

57

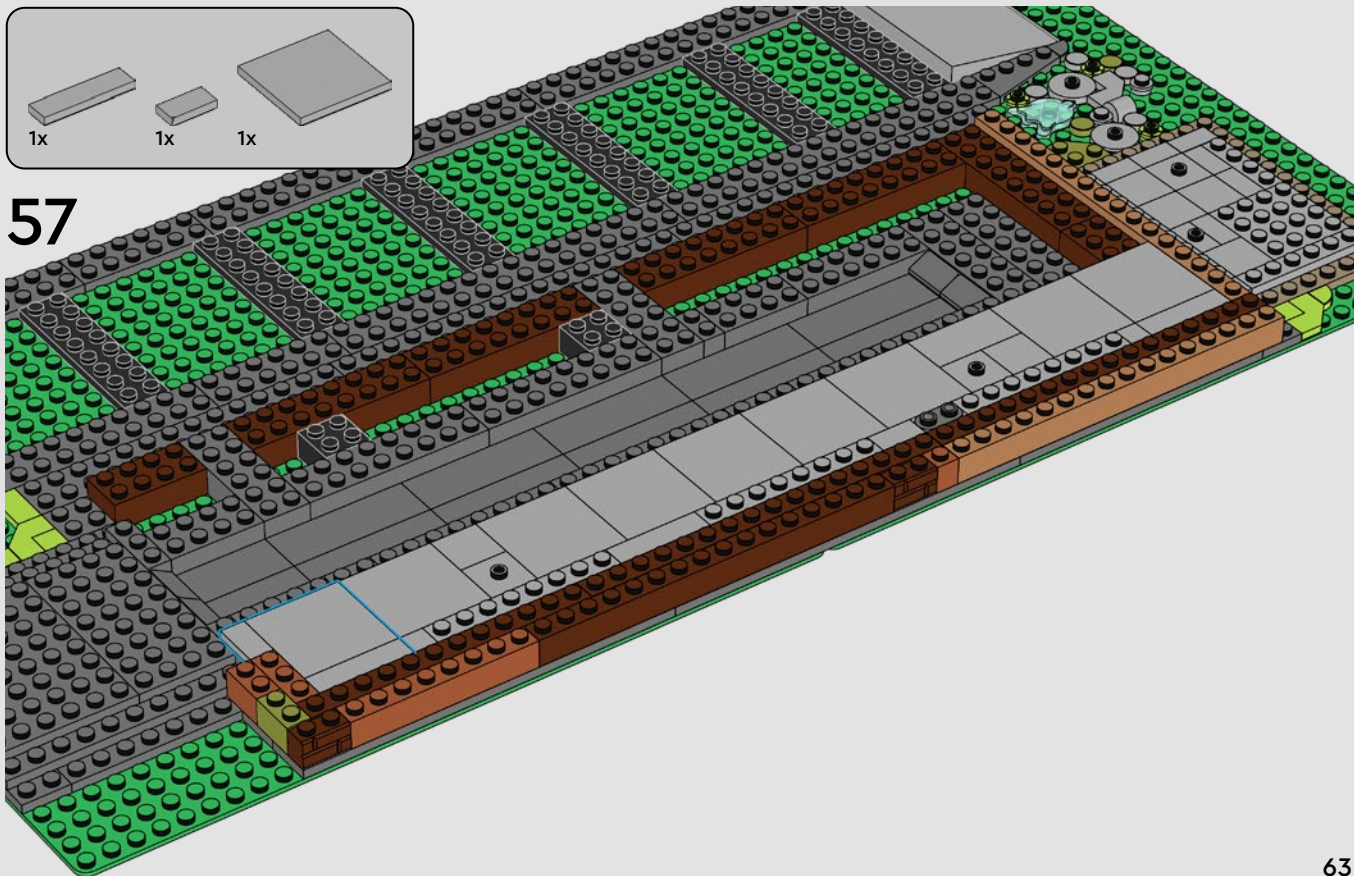

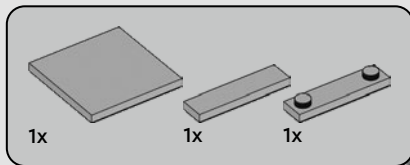

58

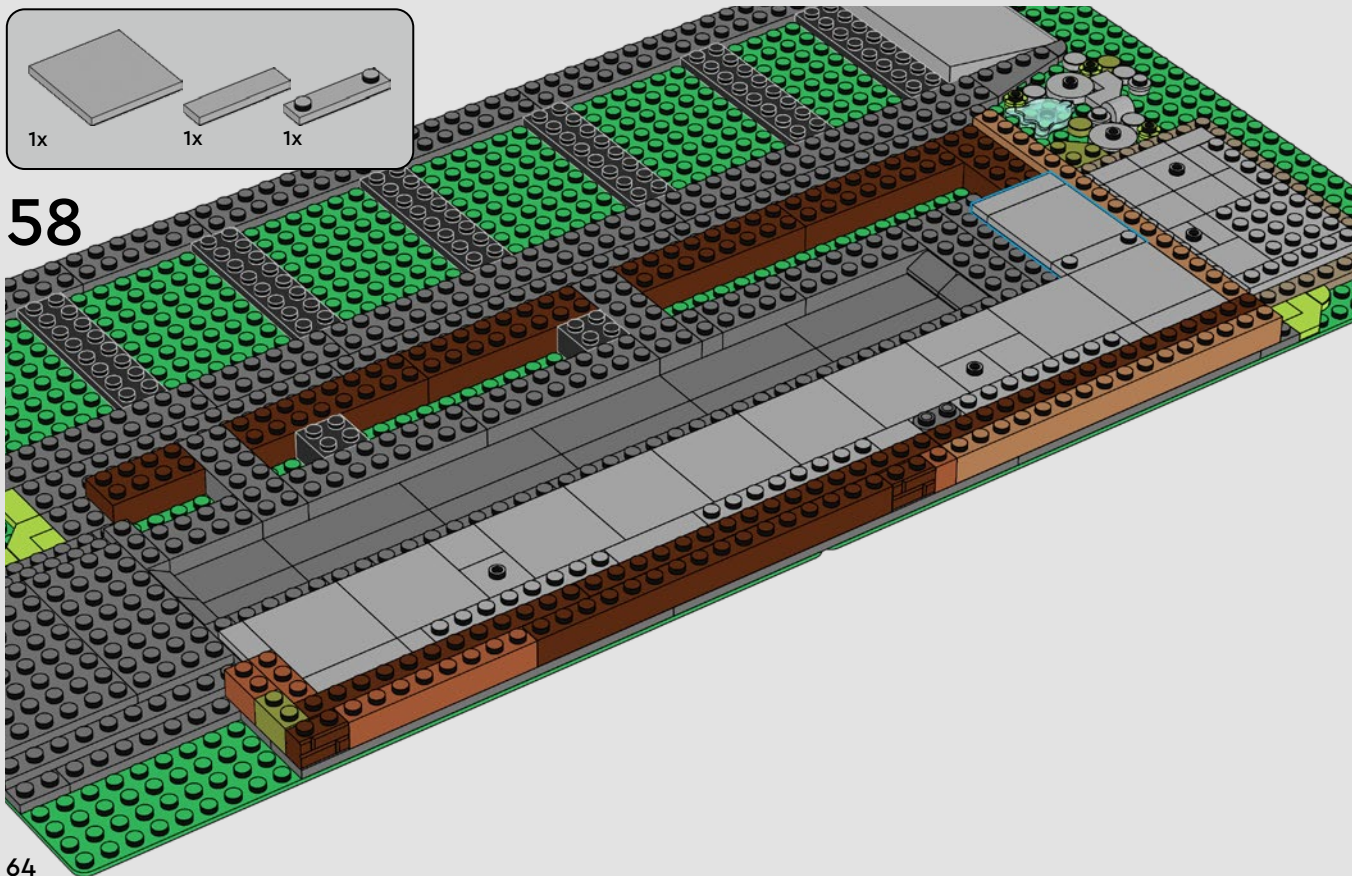

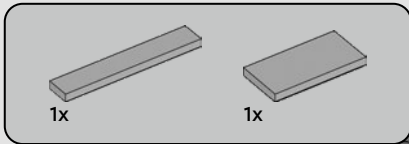

59

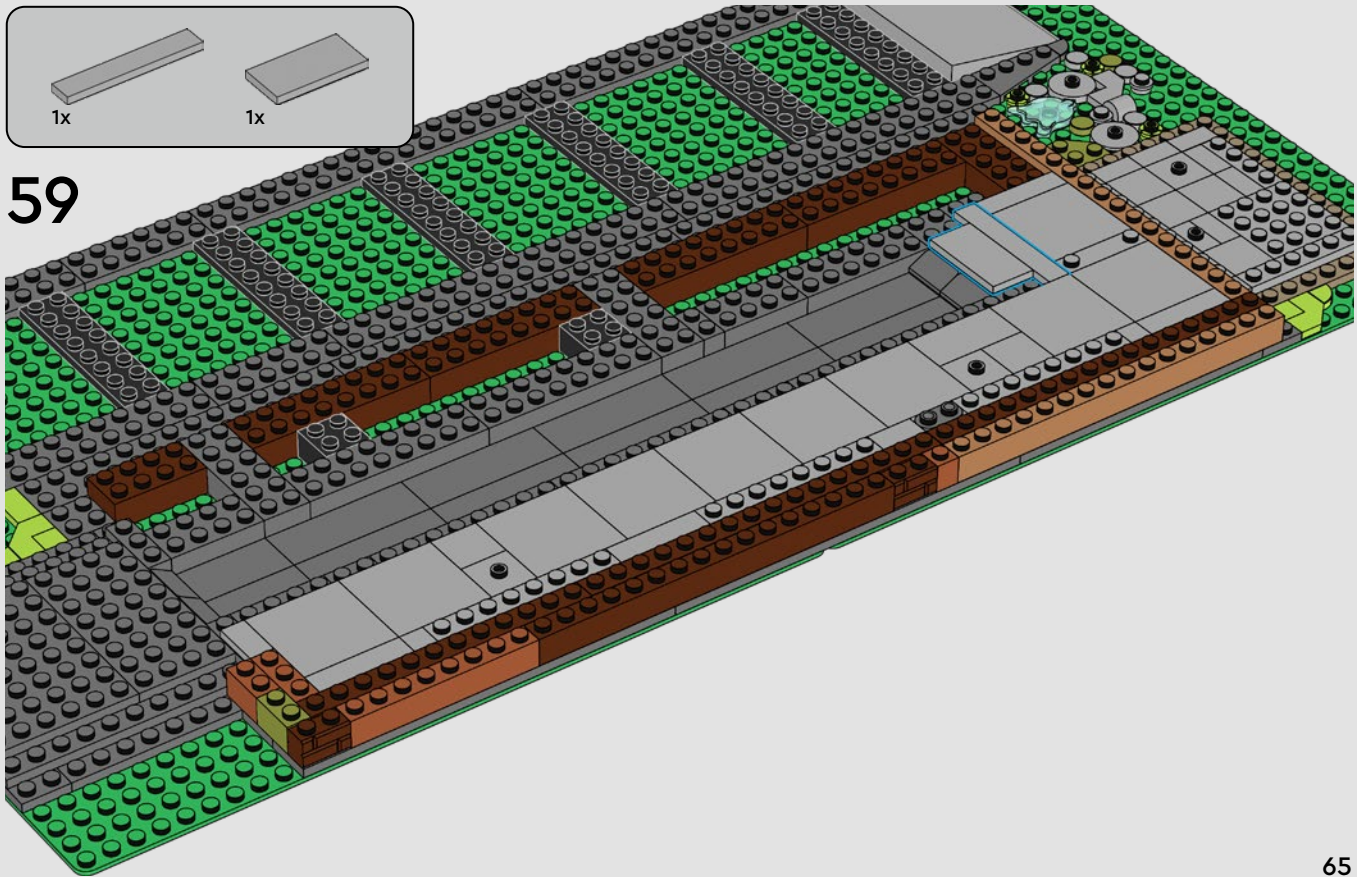

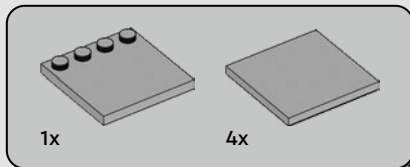

60

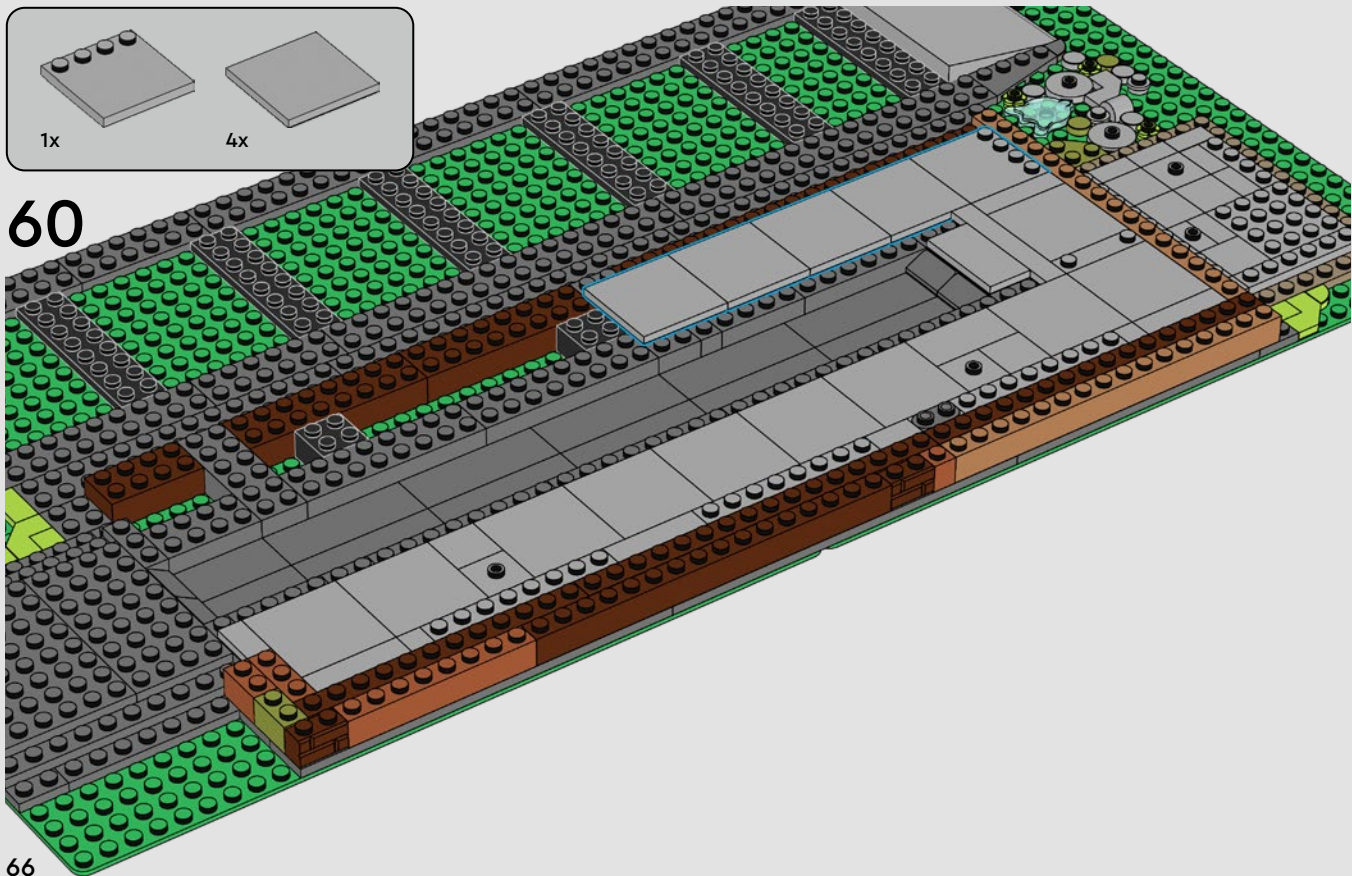

66

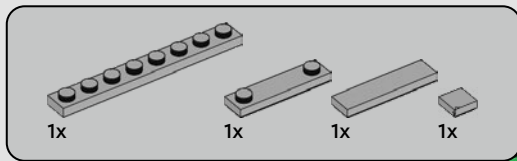

61

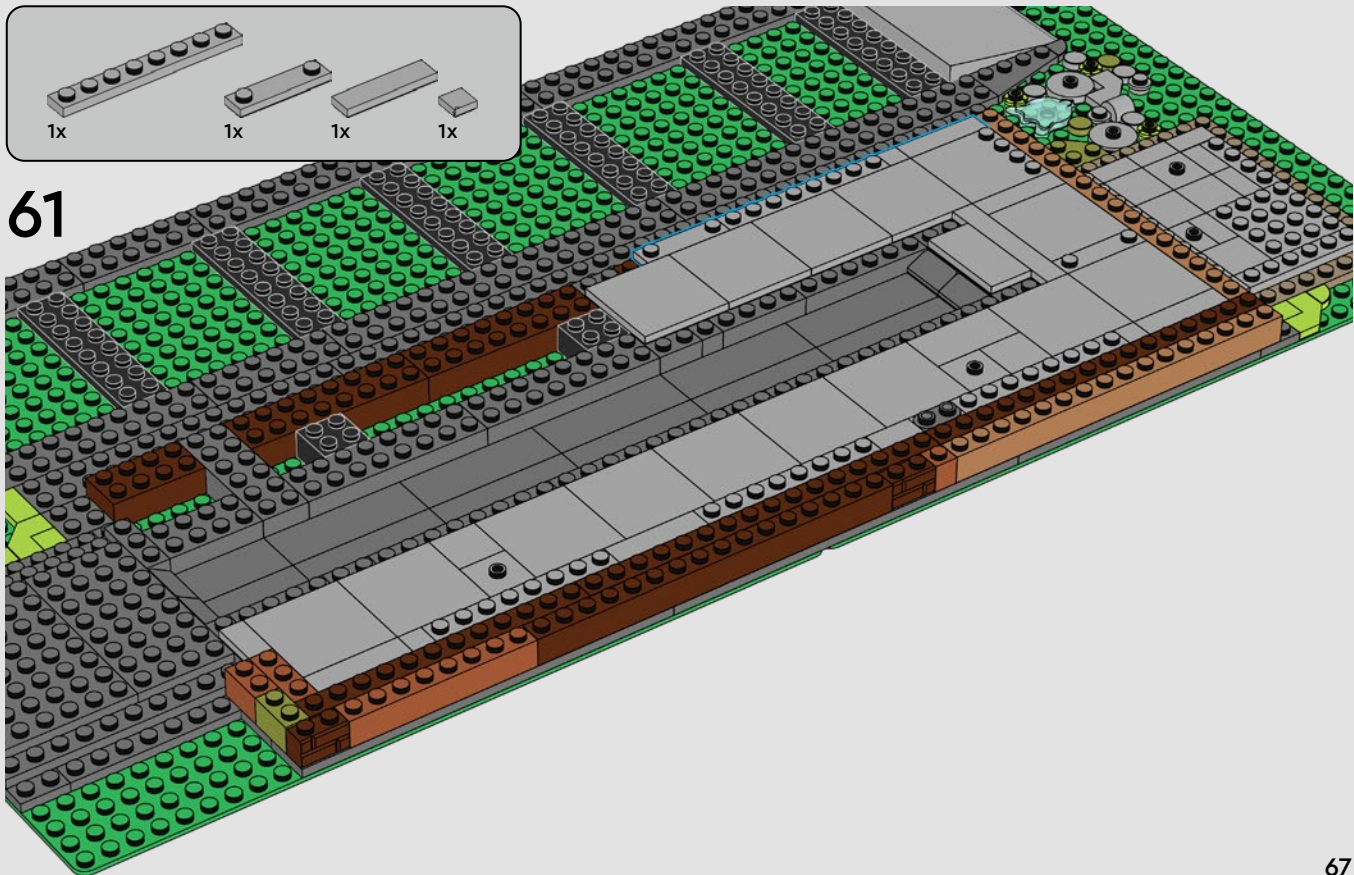

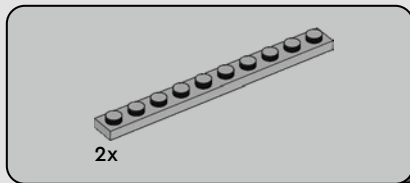

62

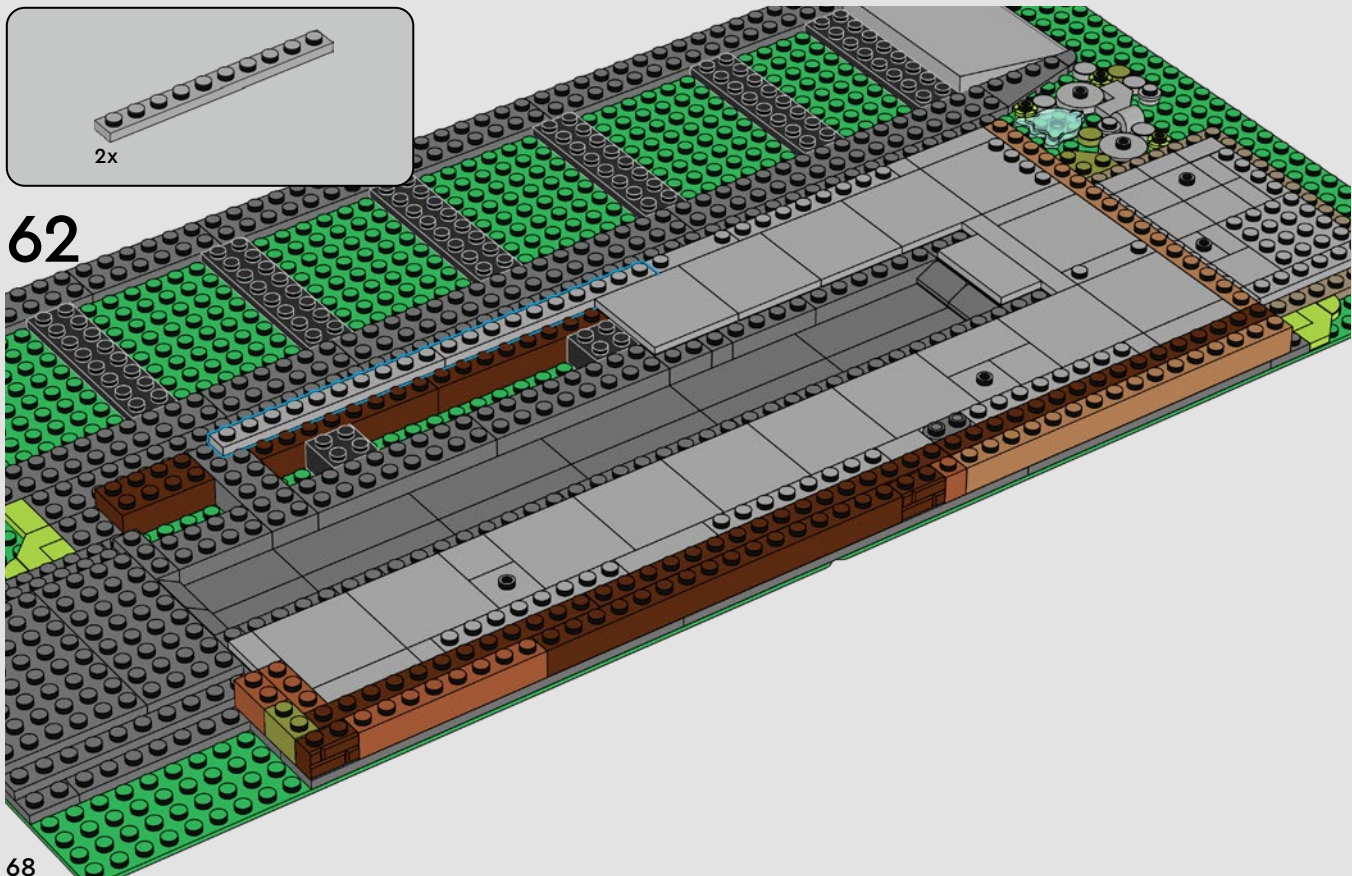

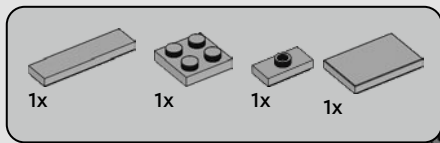

63

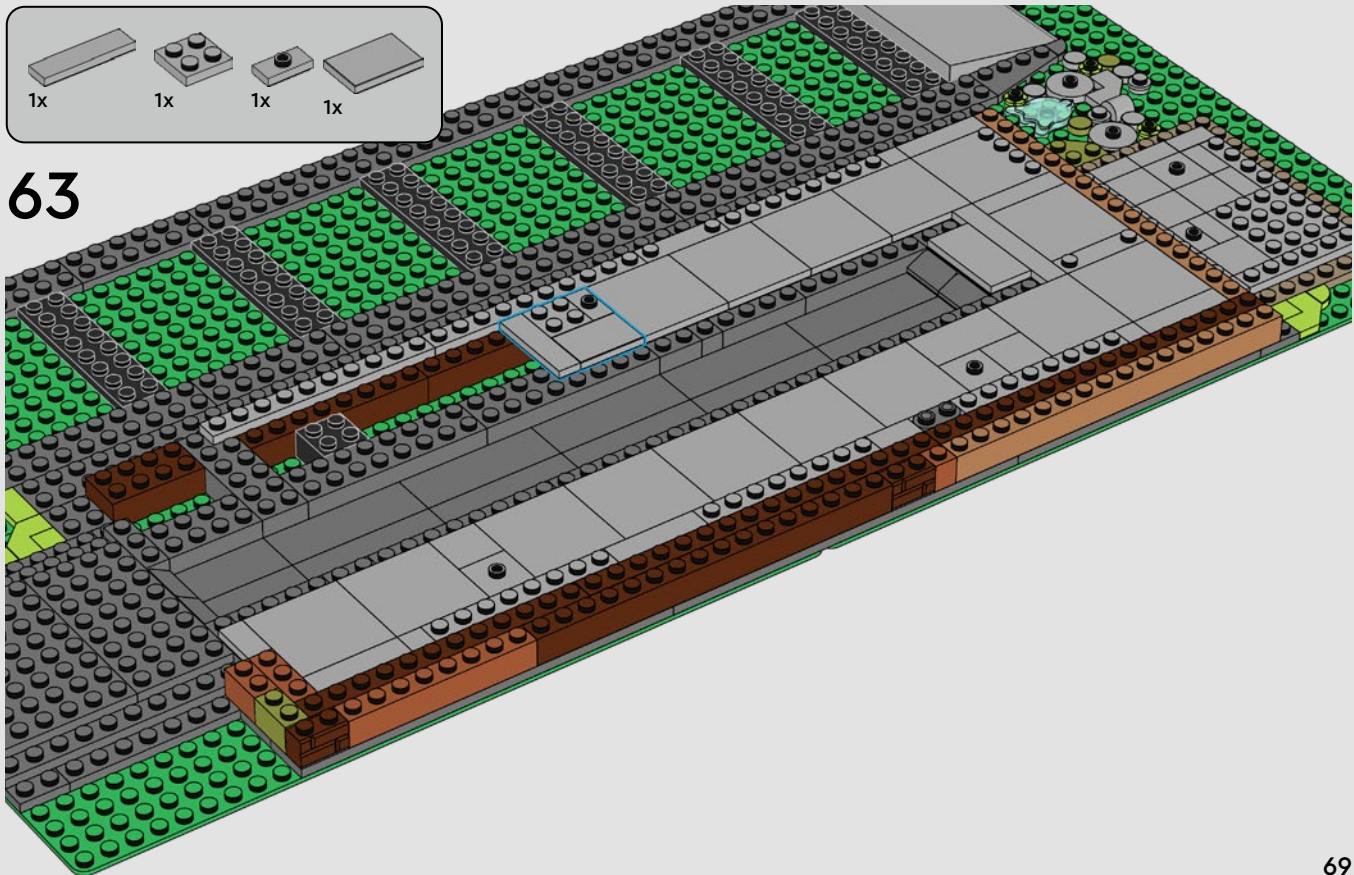

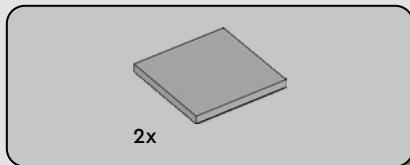

64

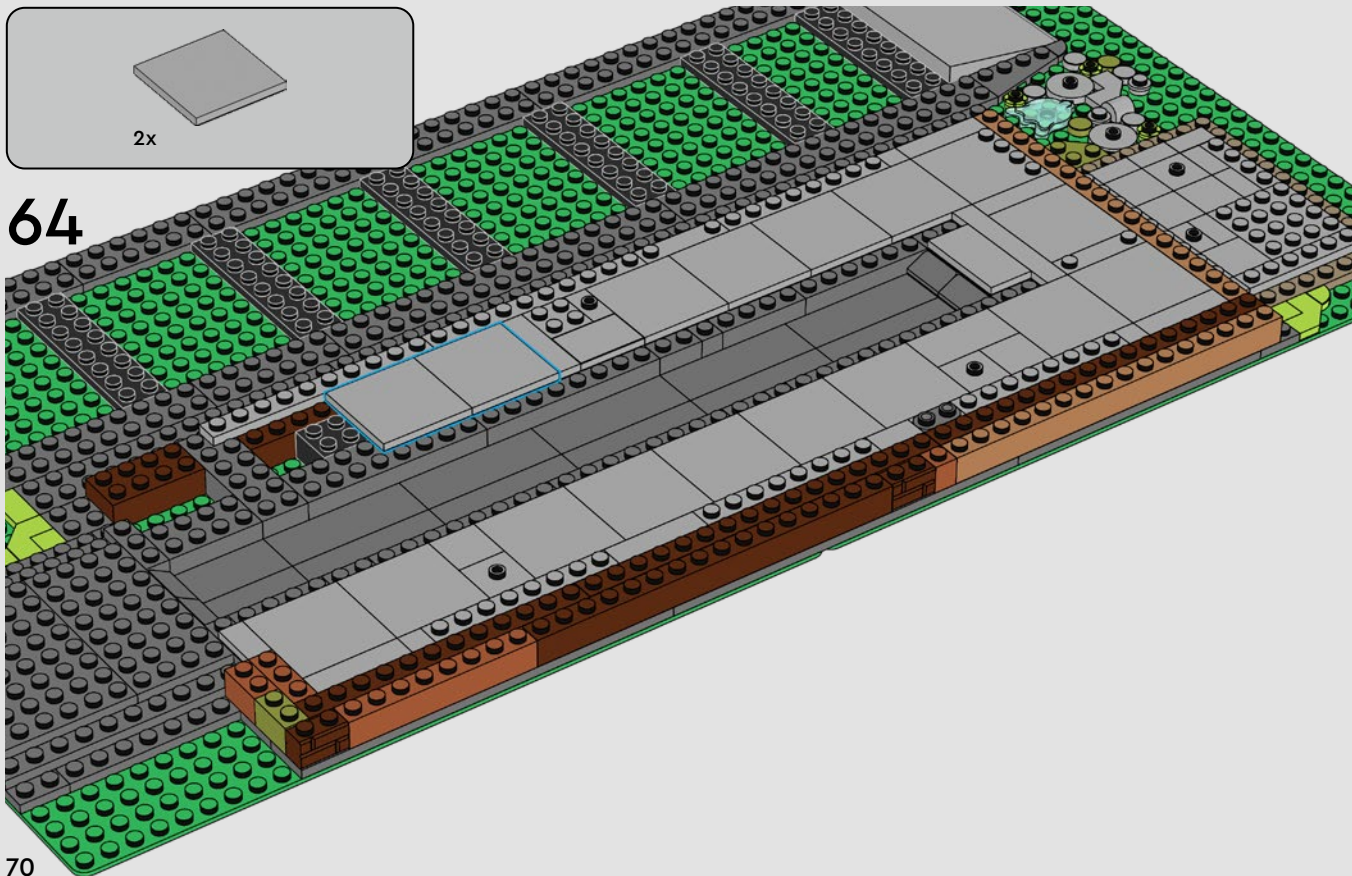

70

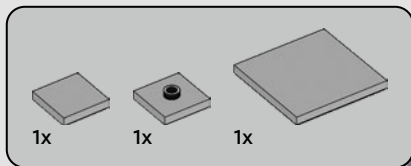

65

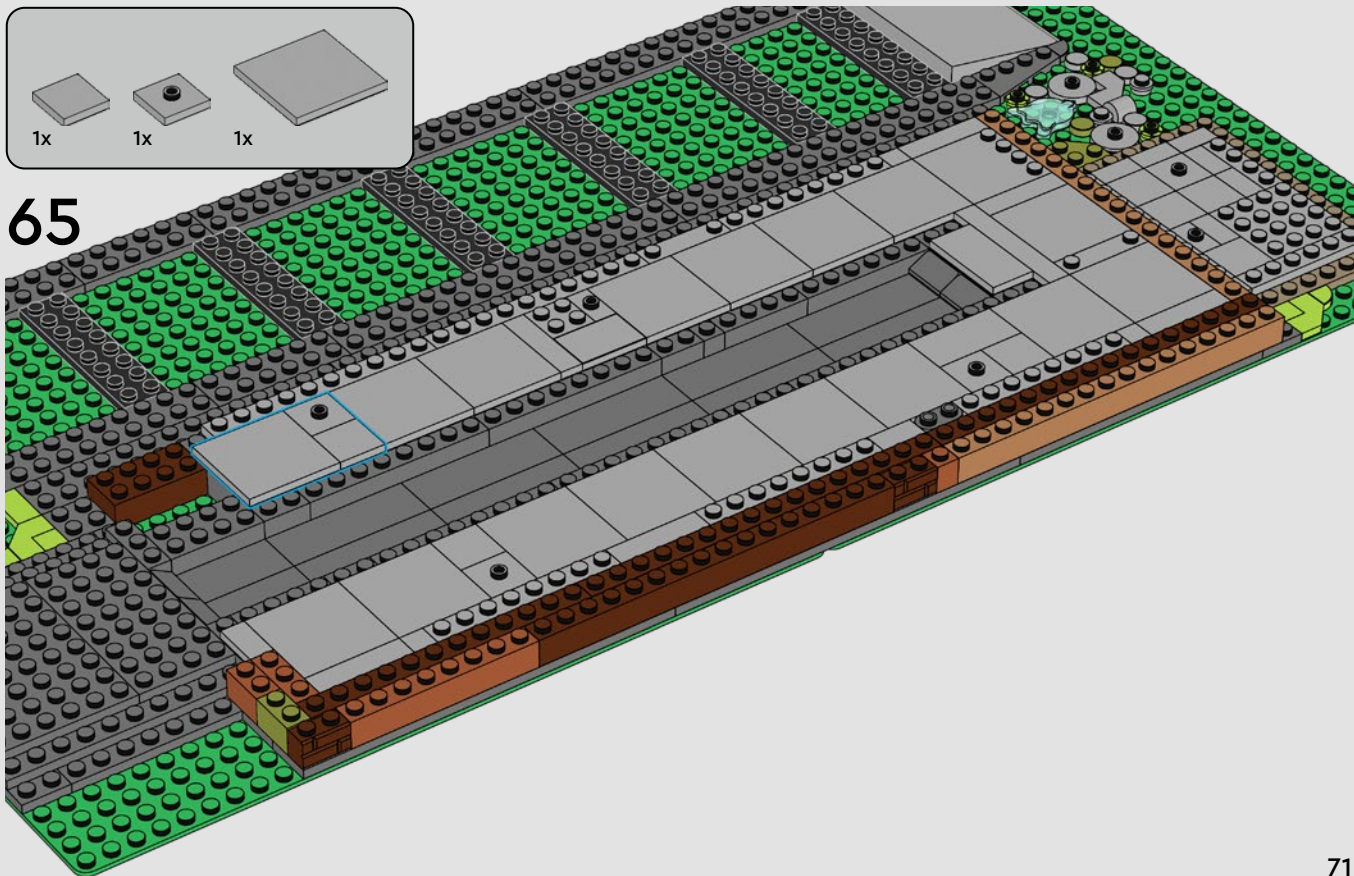

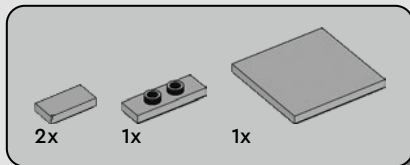

66

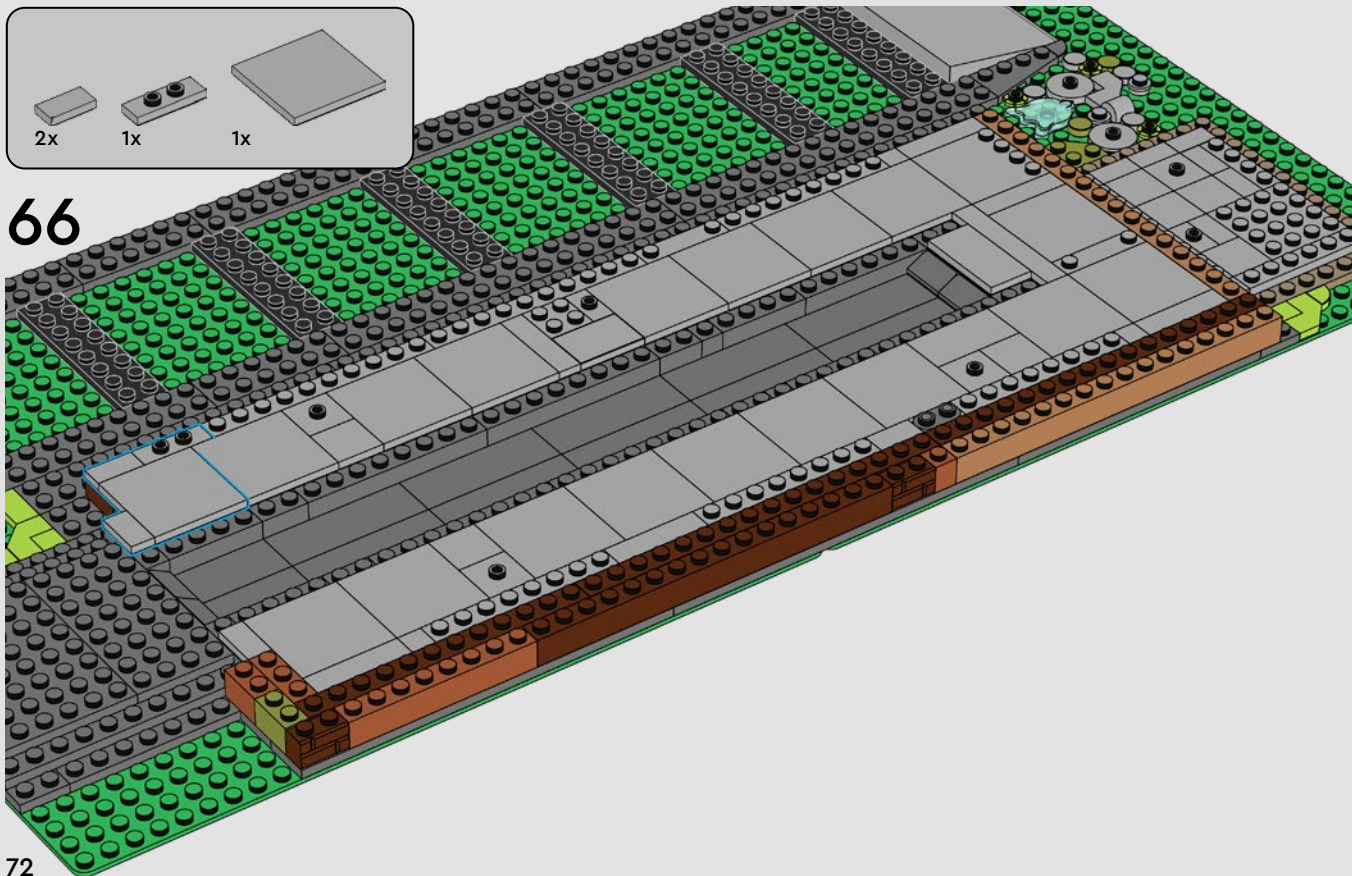

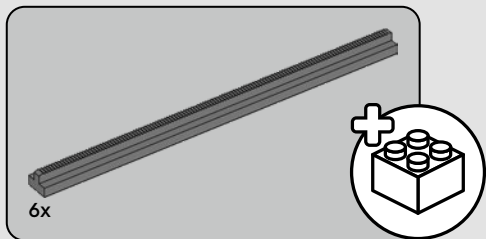

67

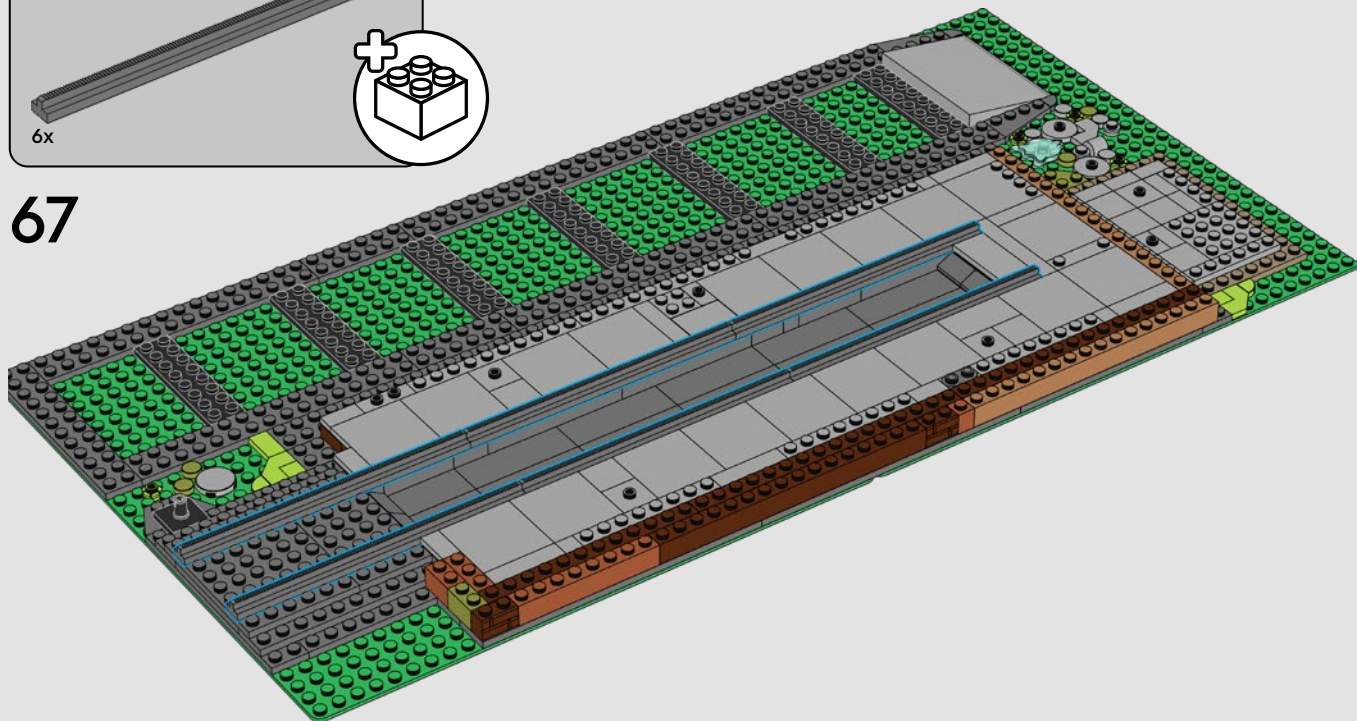



5x

68

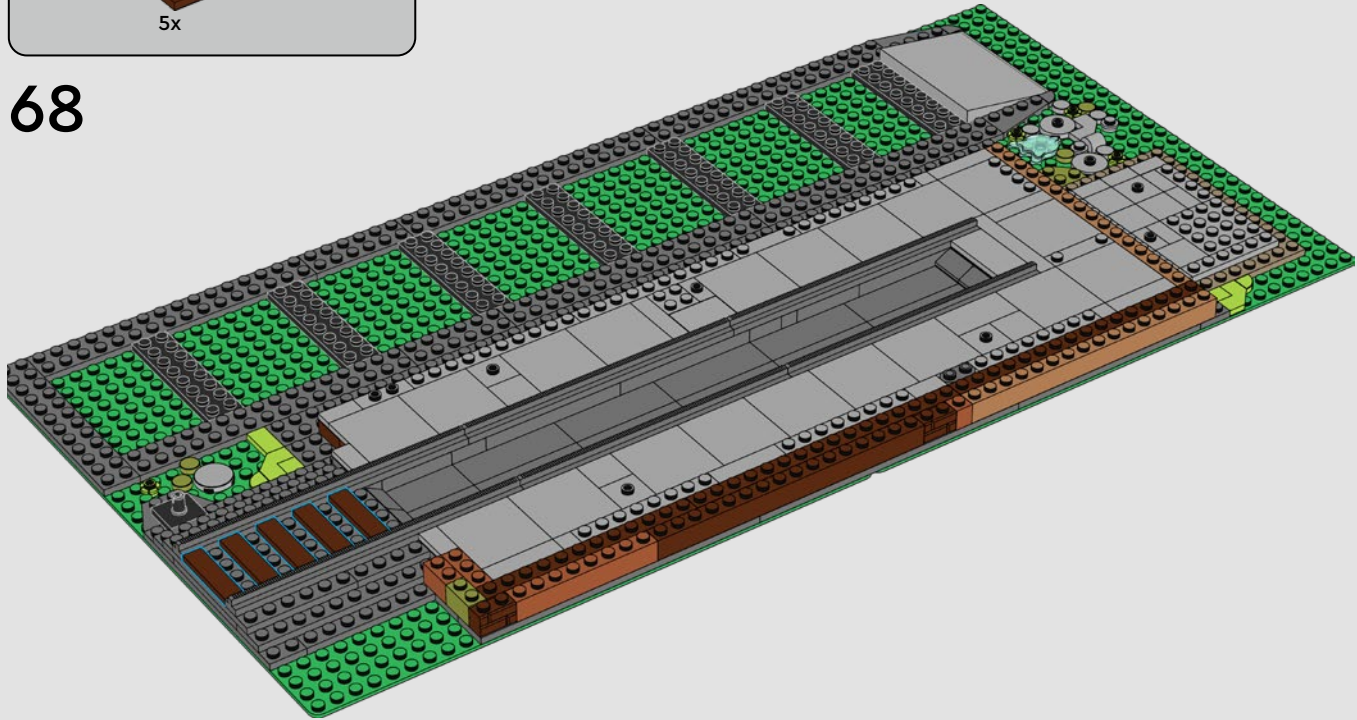



10x

69

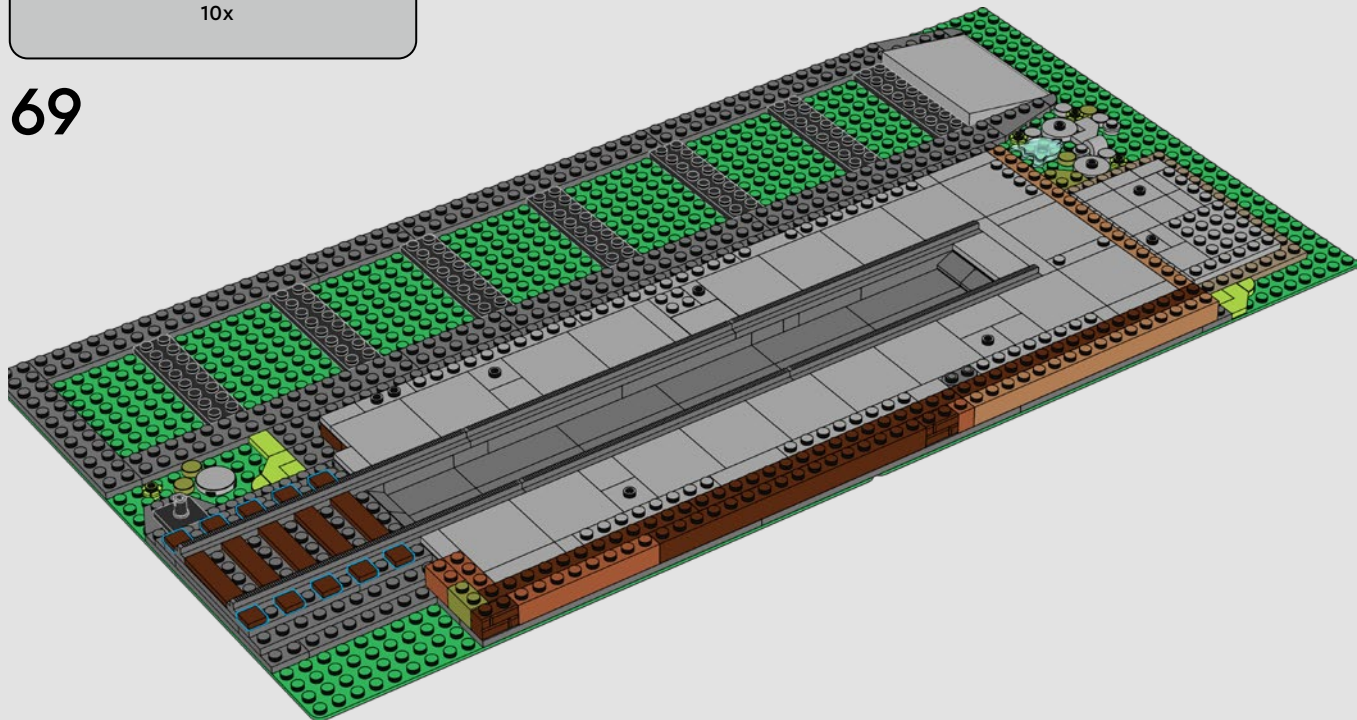

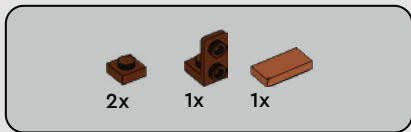

70

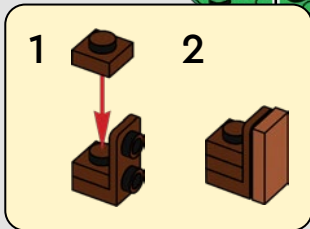
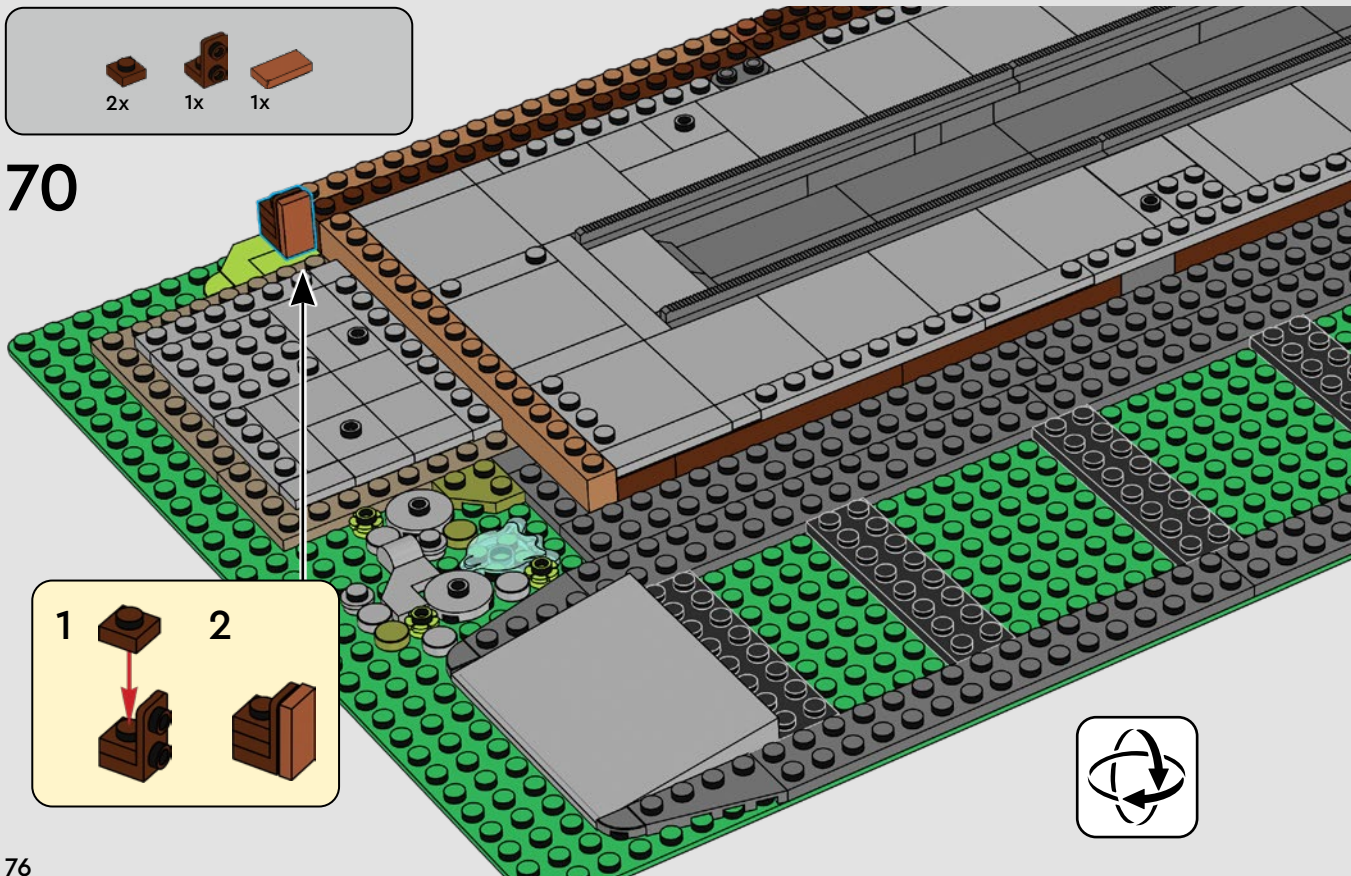

76

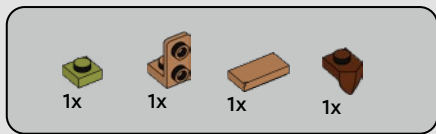

71

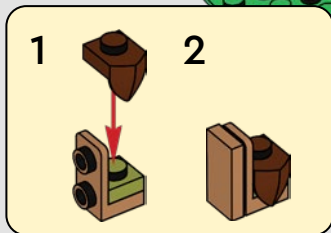
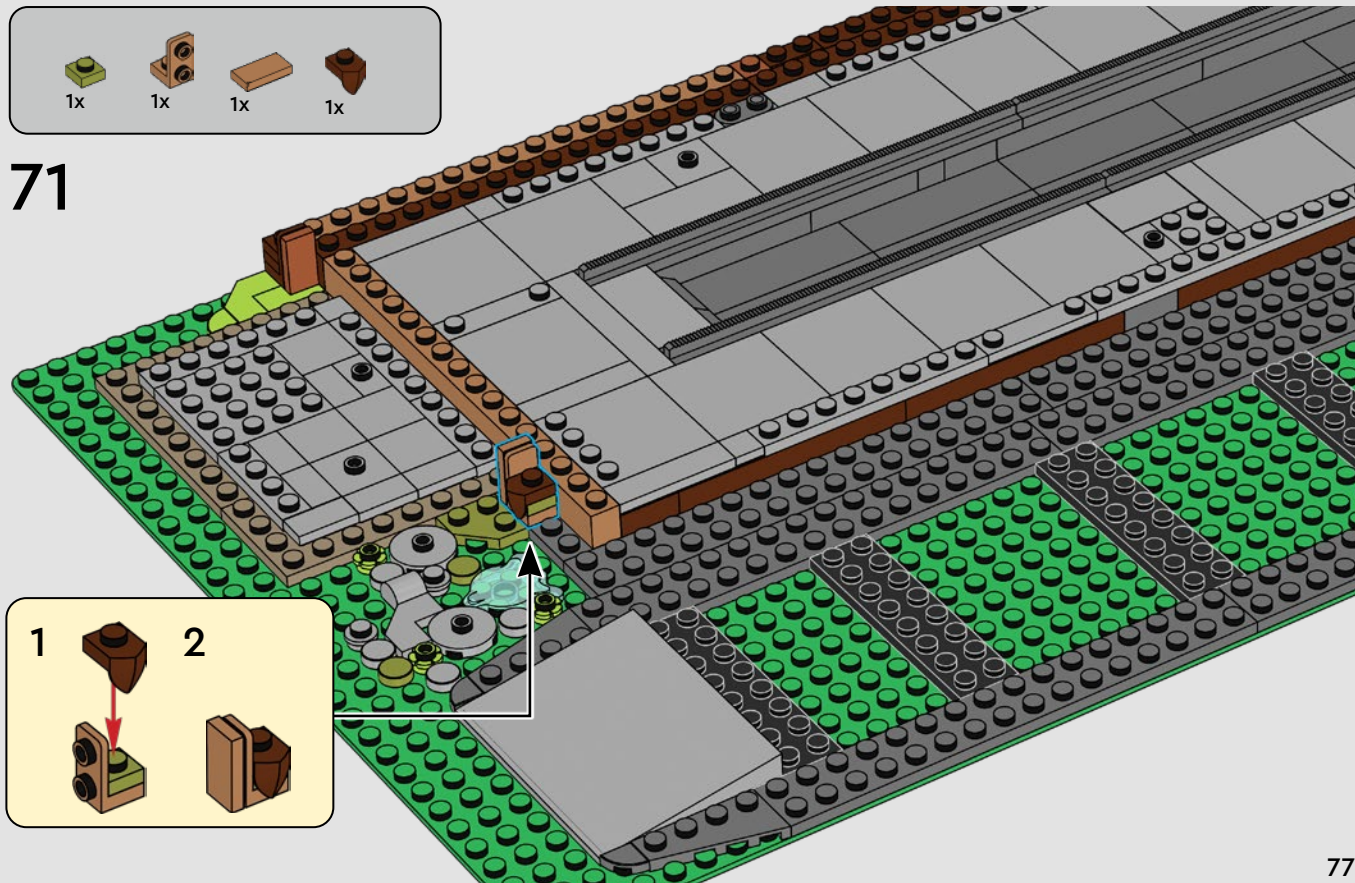

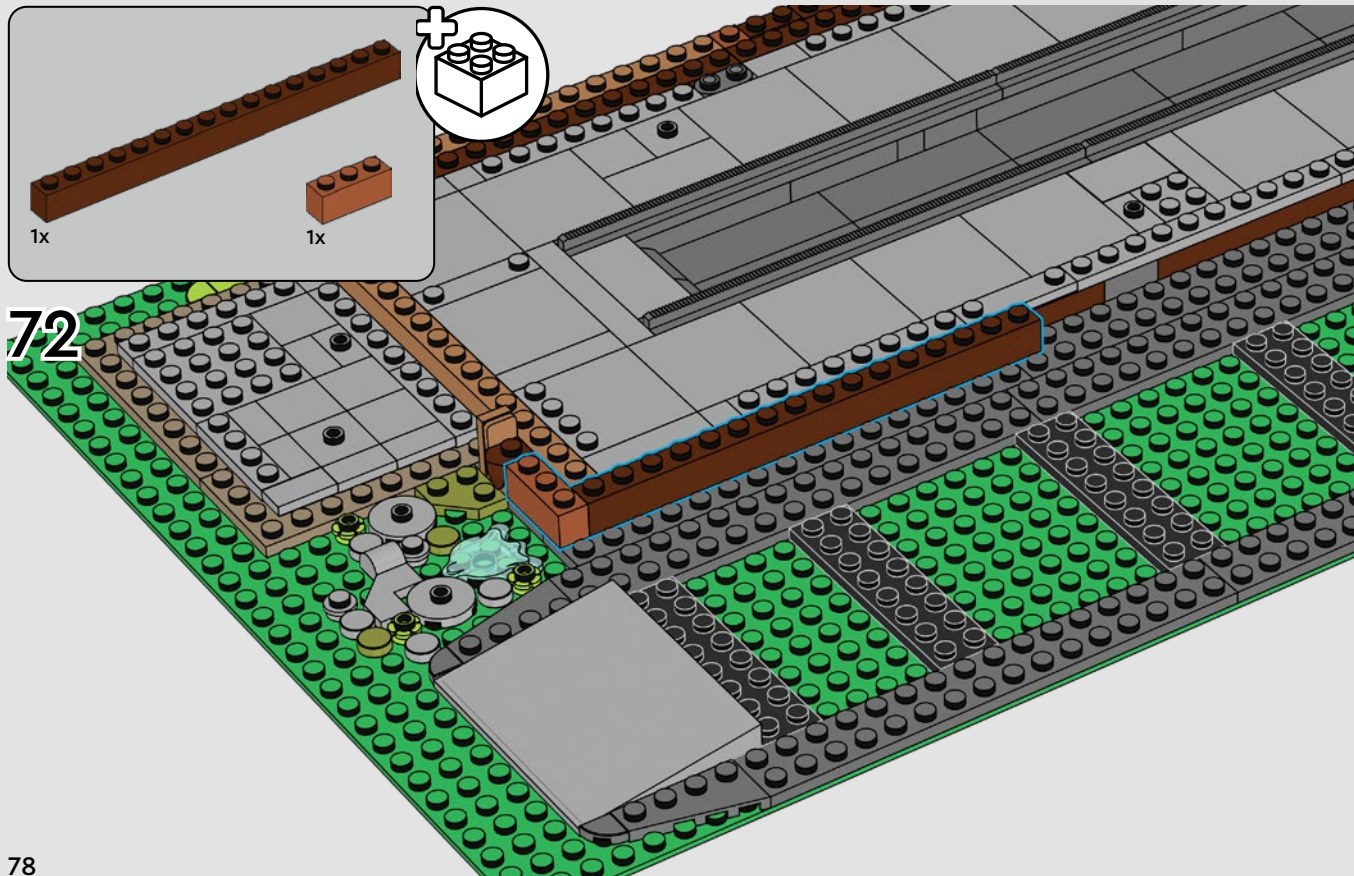

73

1x

1x

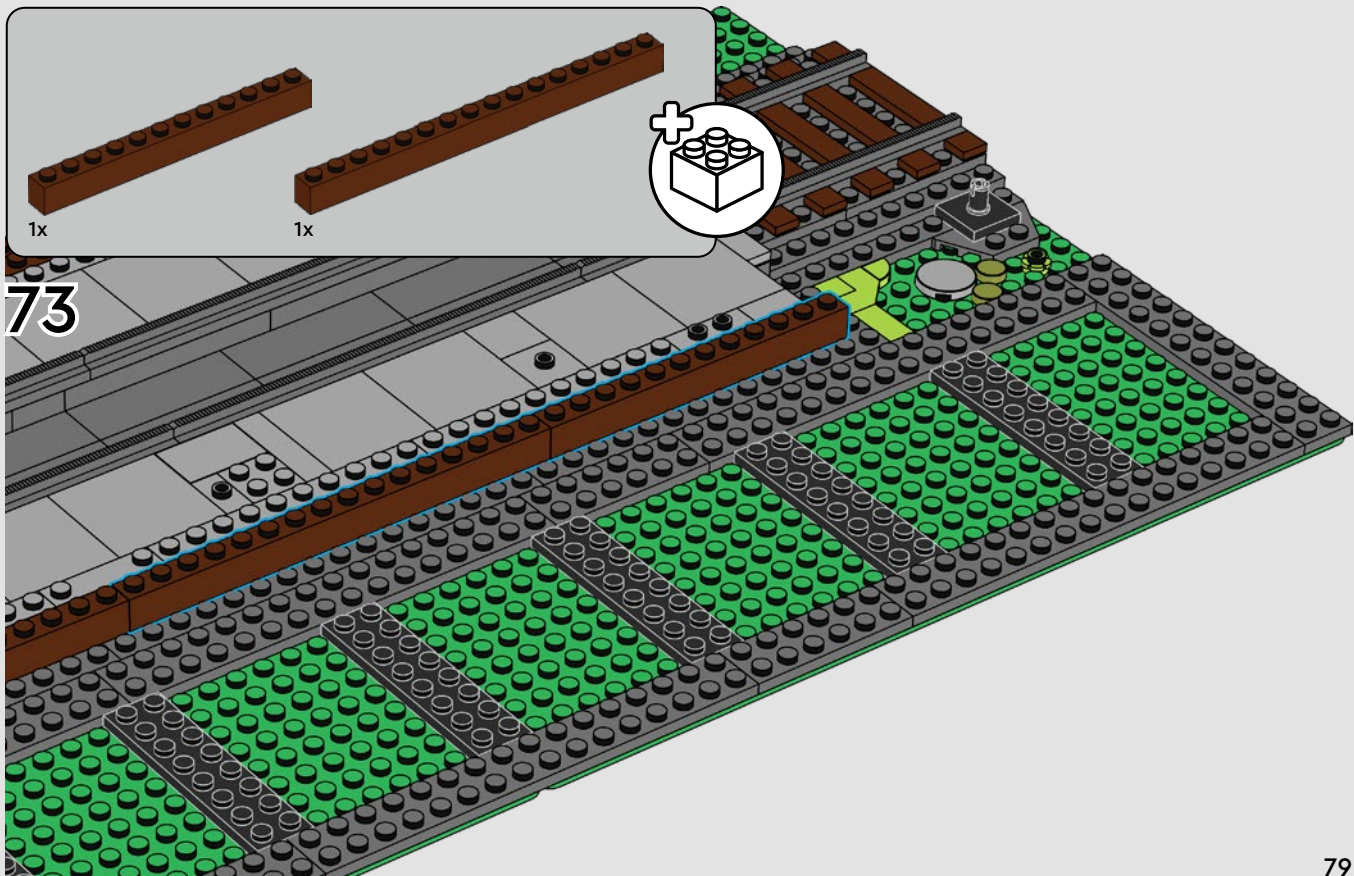

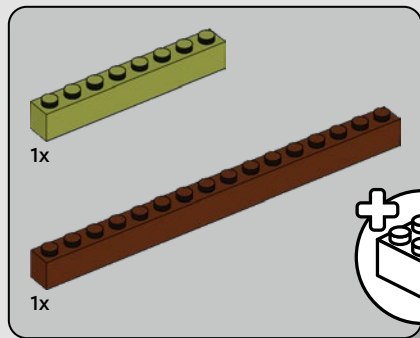

74

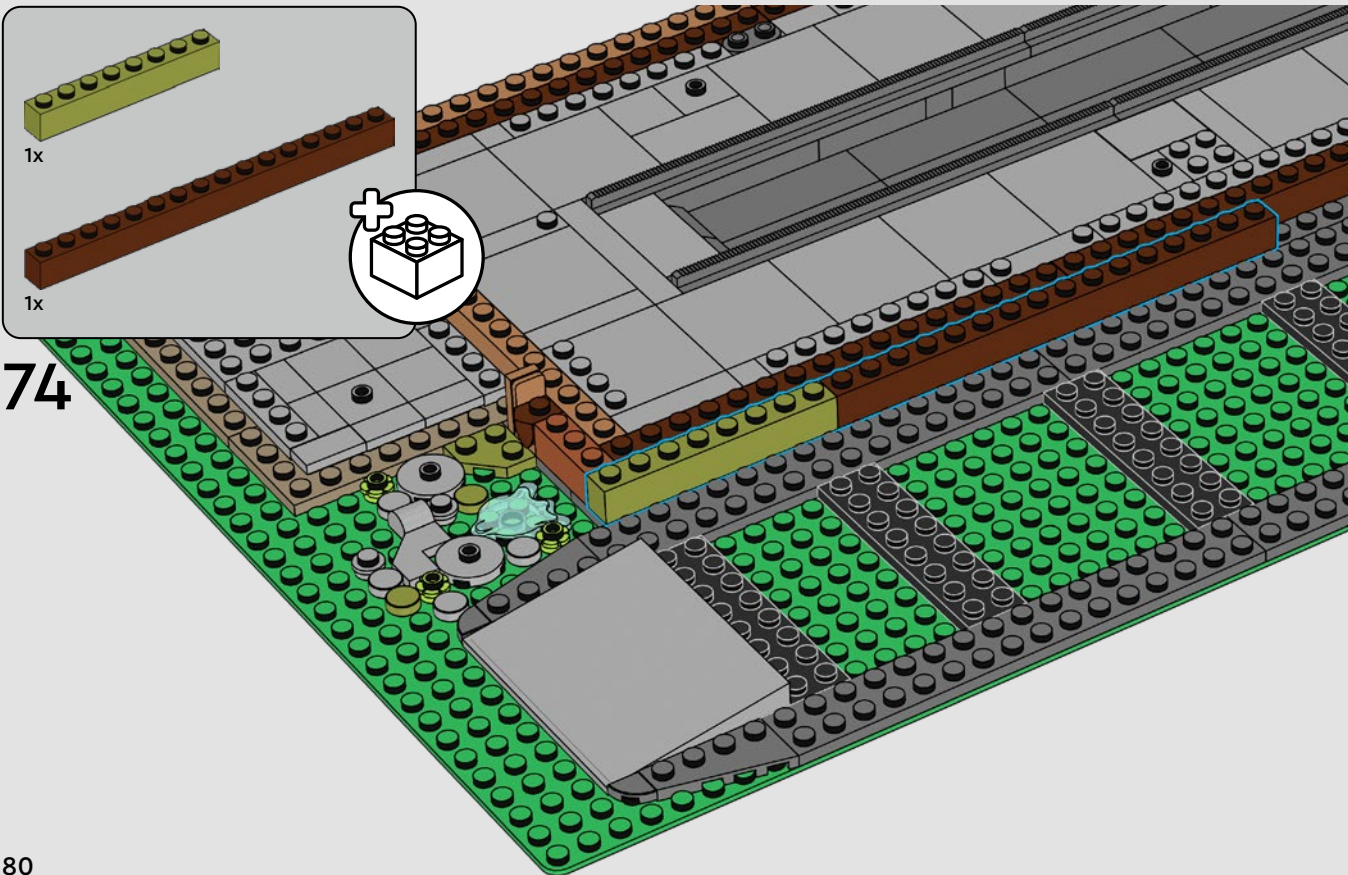

75

1x

1x

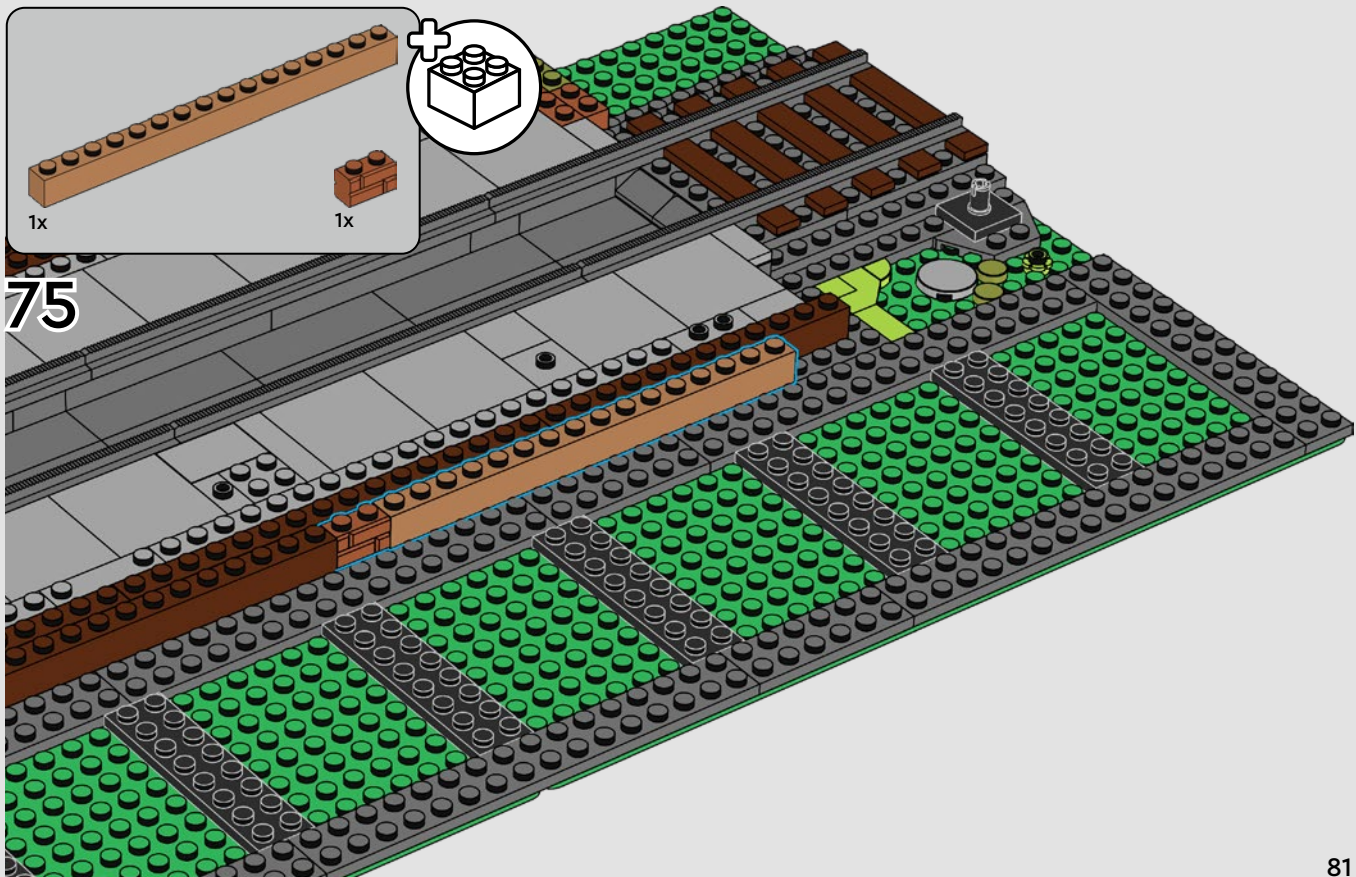

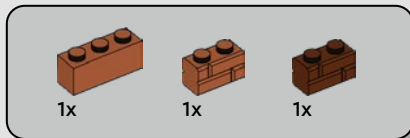

76

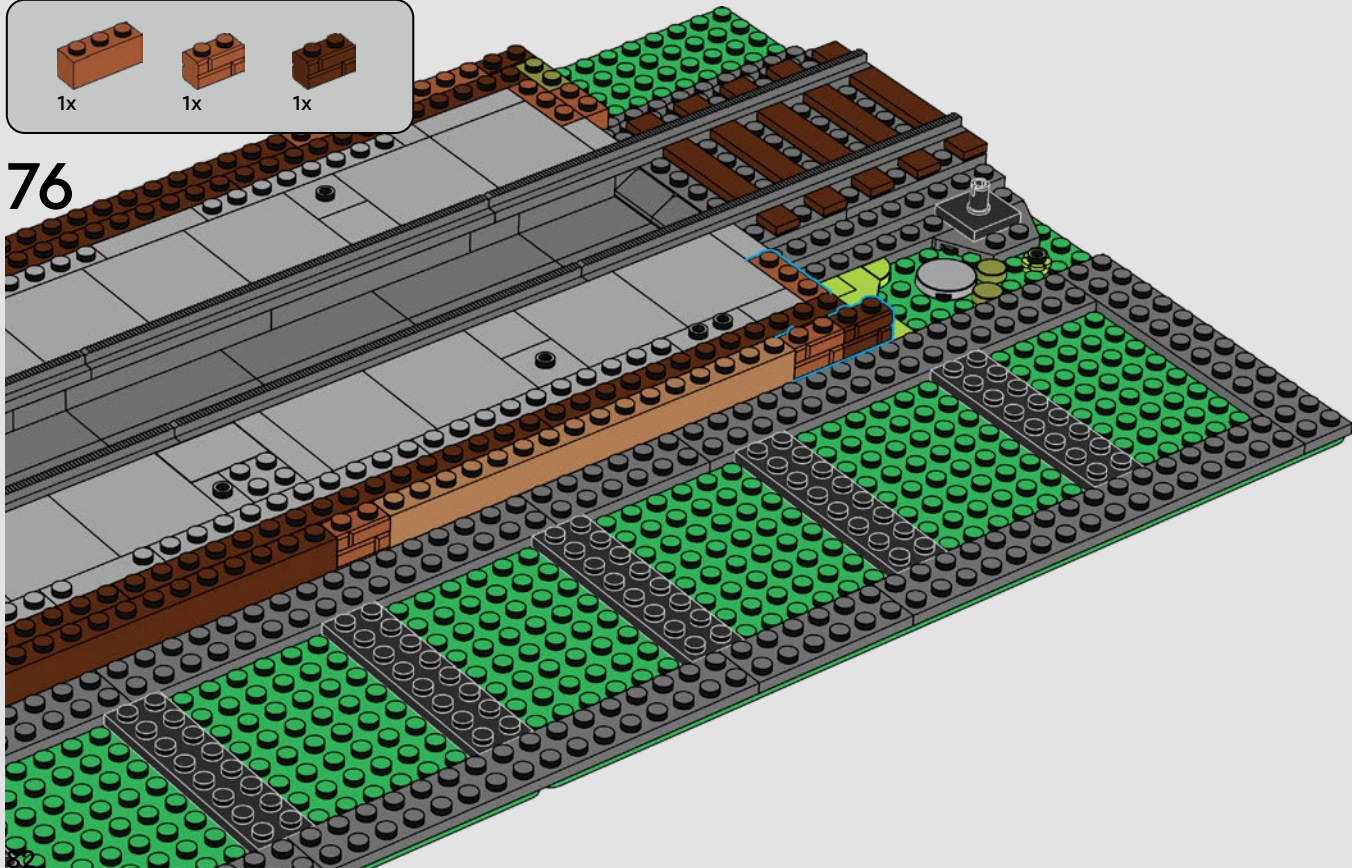



1x



1x

77

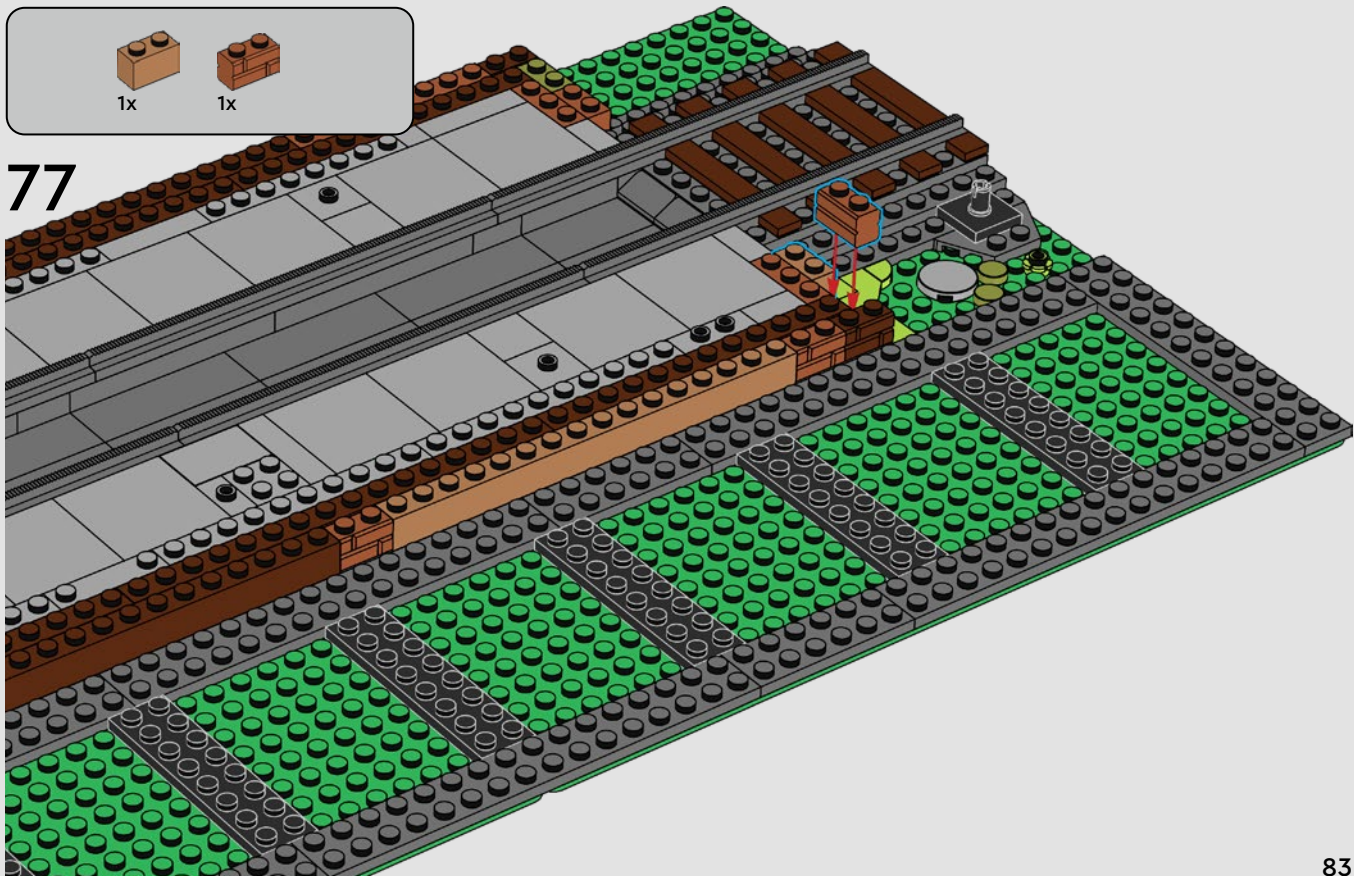

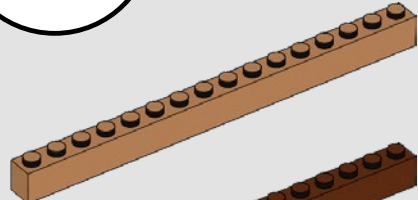
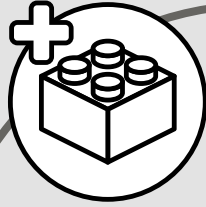

3x

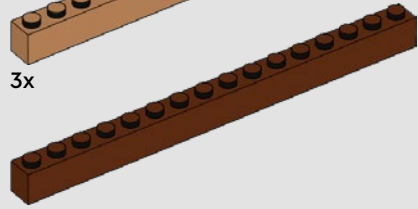

1x



78

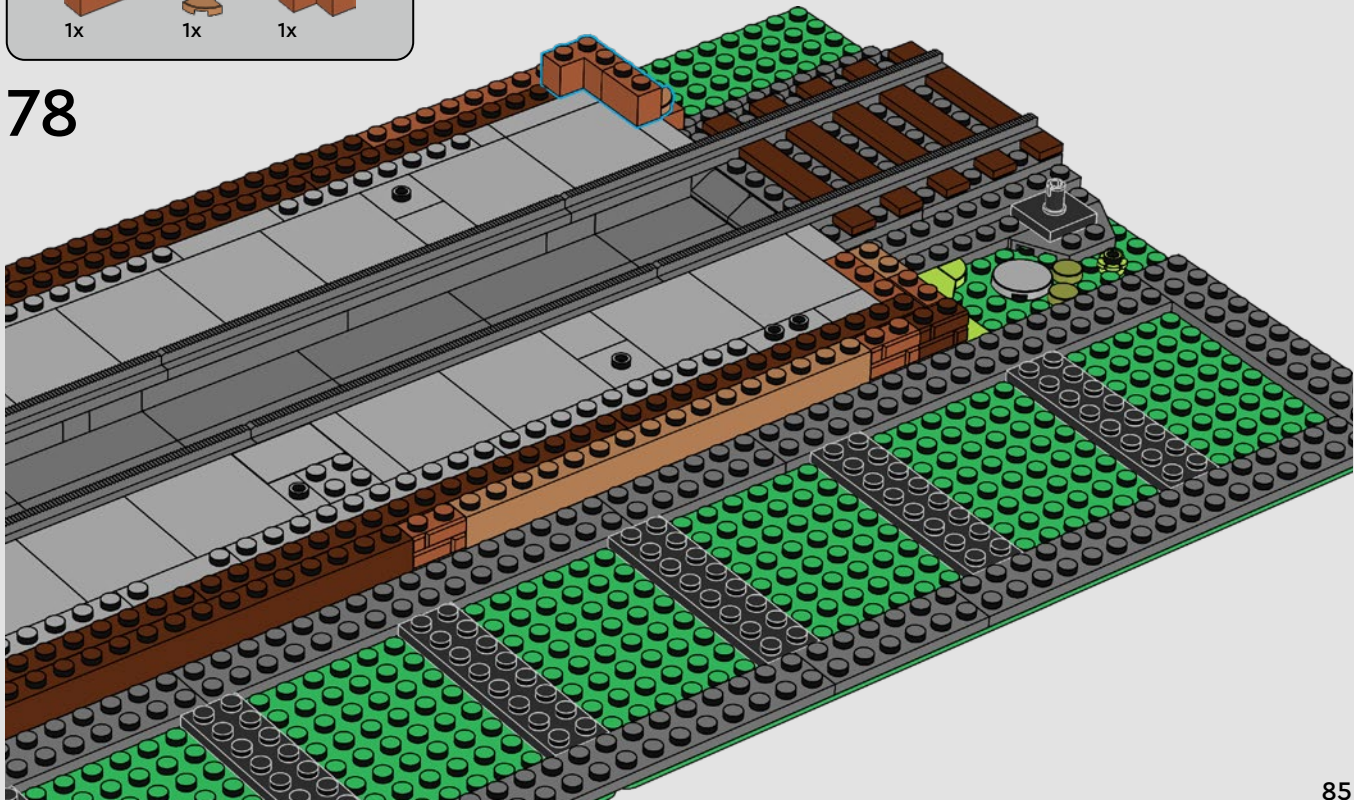

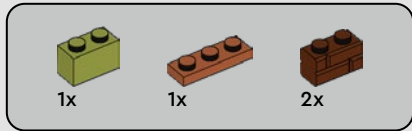

79

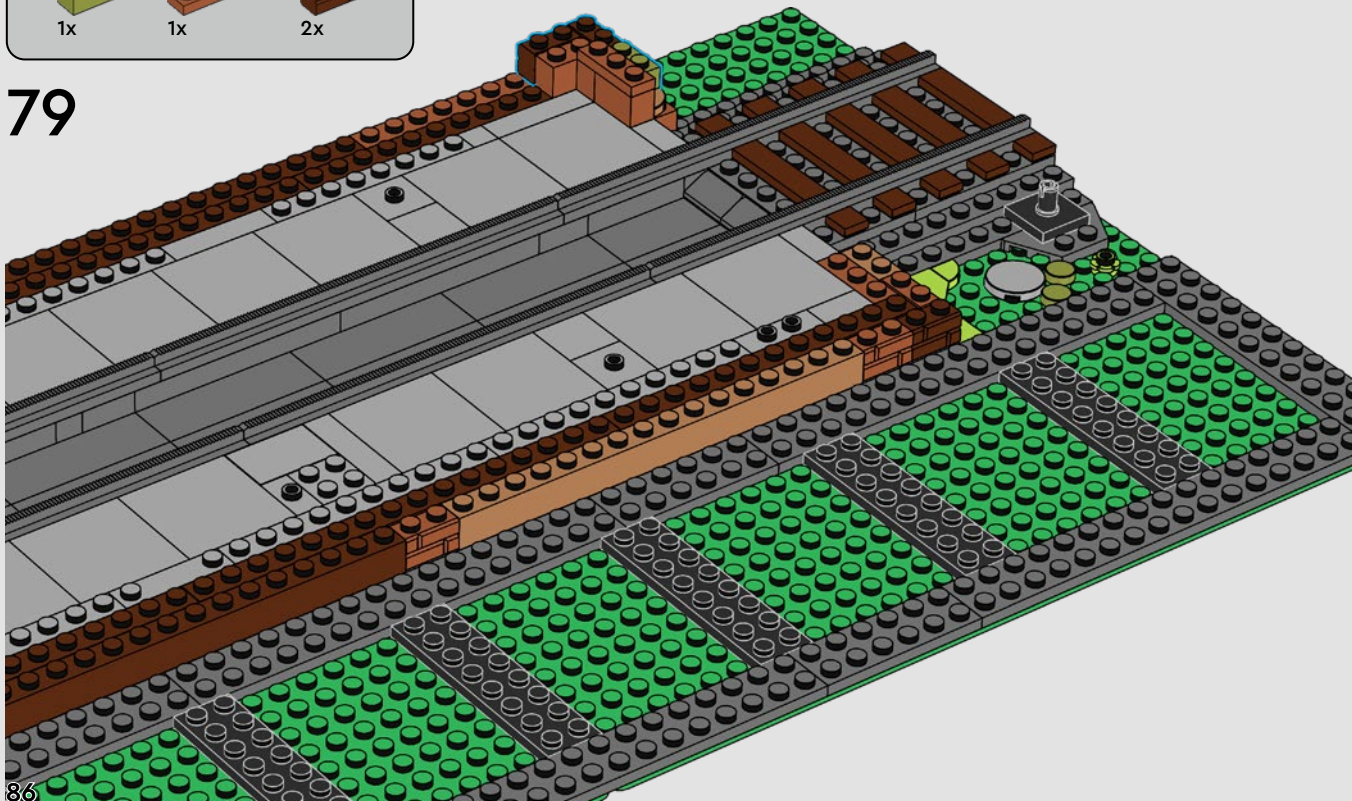

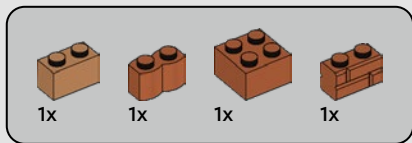

80

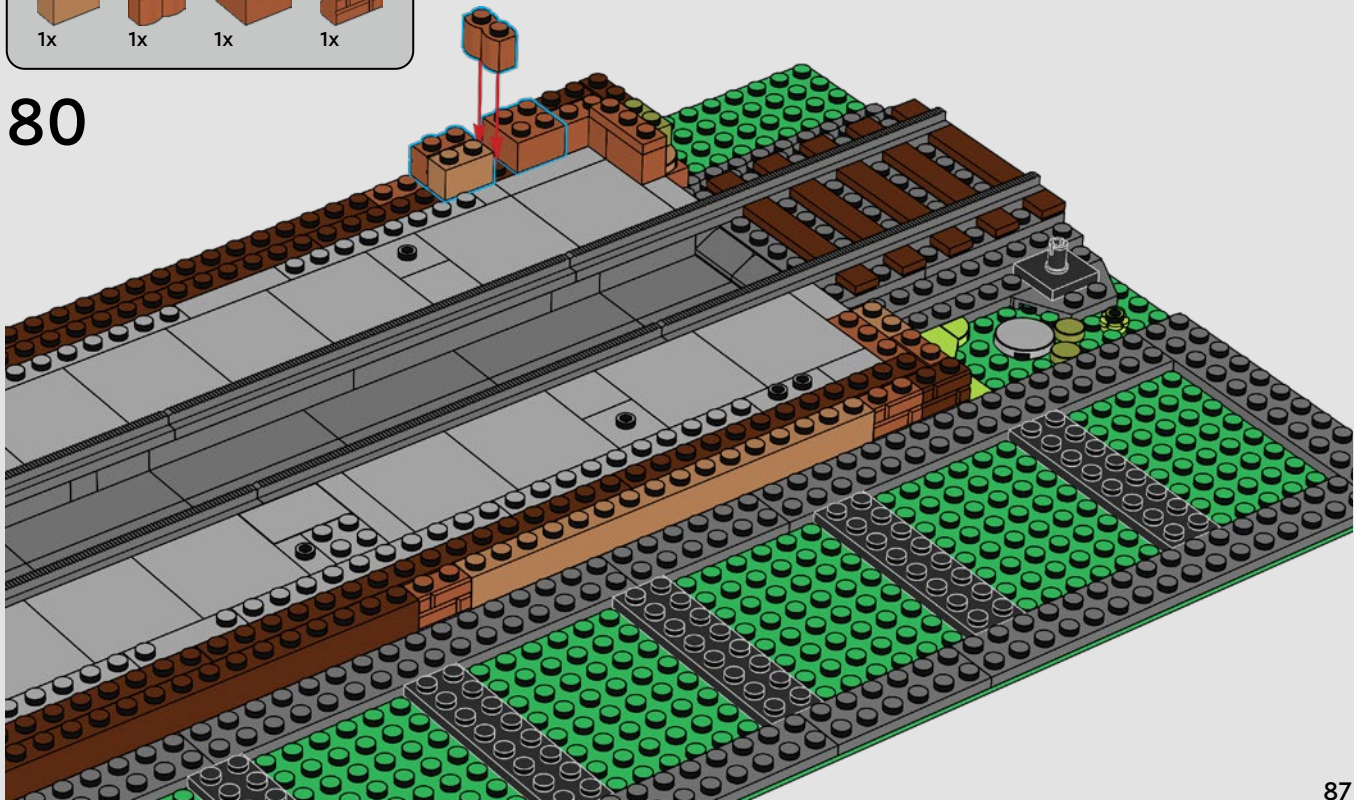

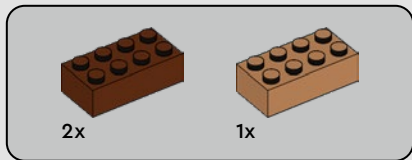

81

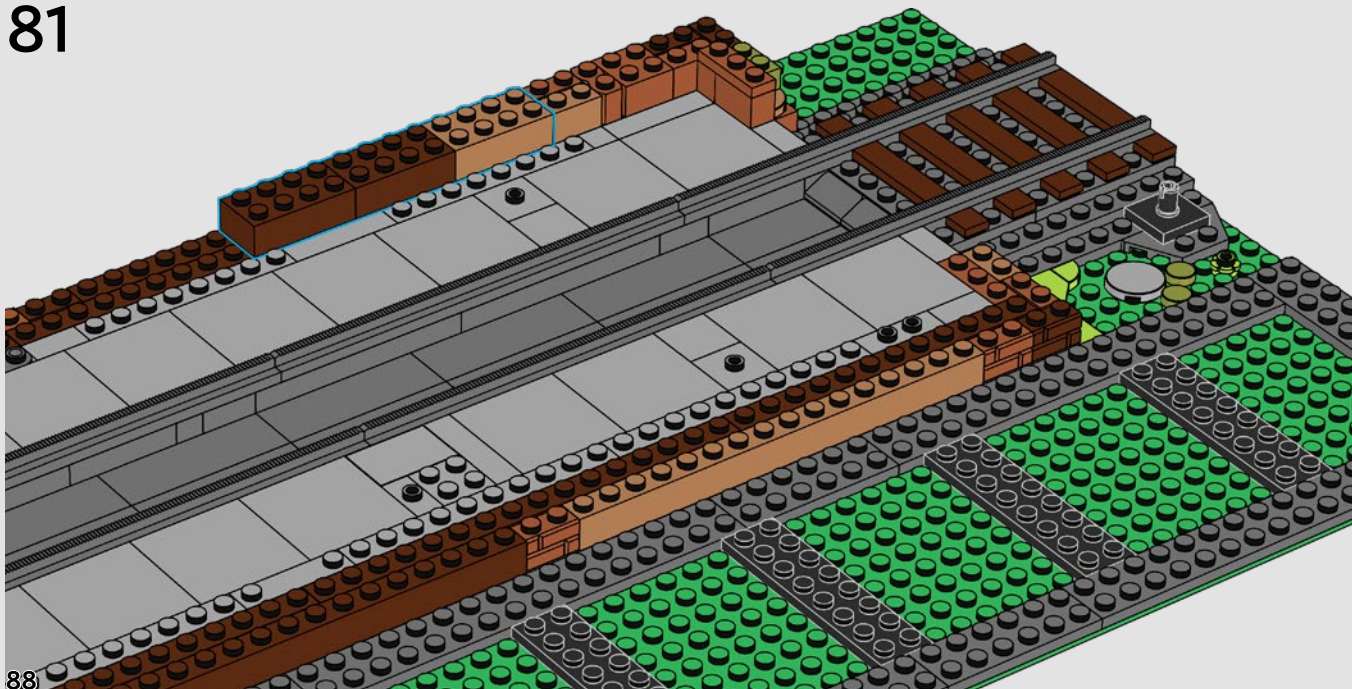

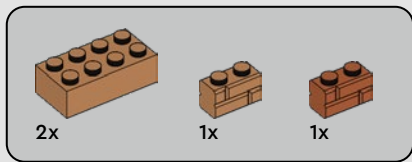

82

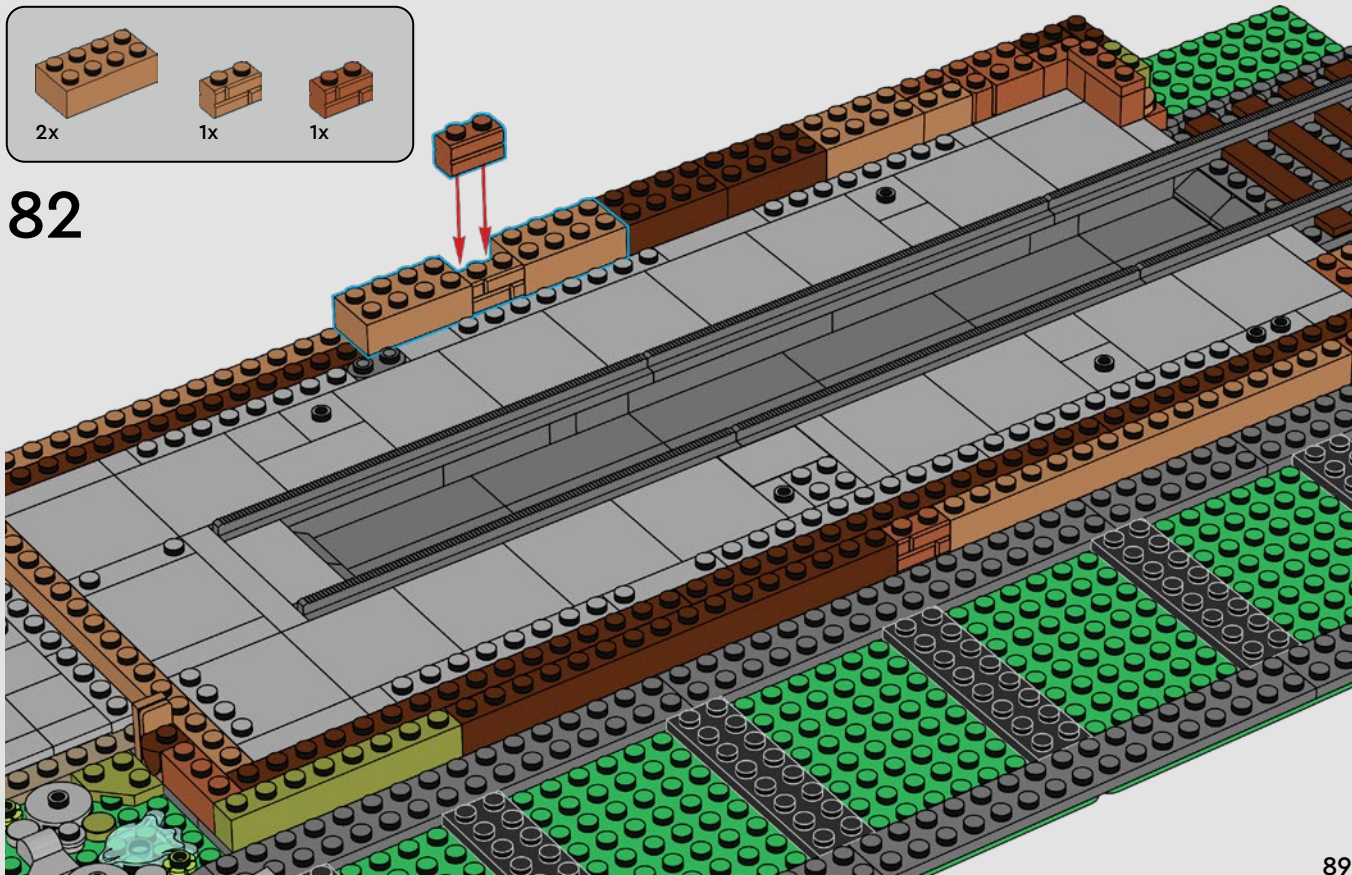

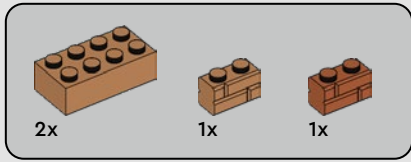

83

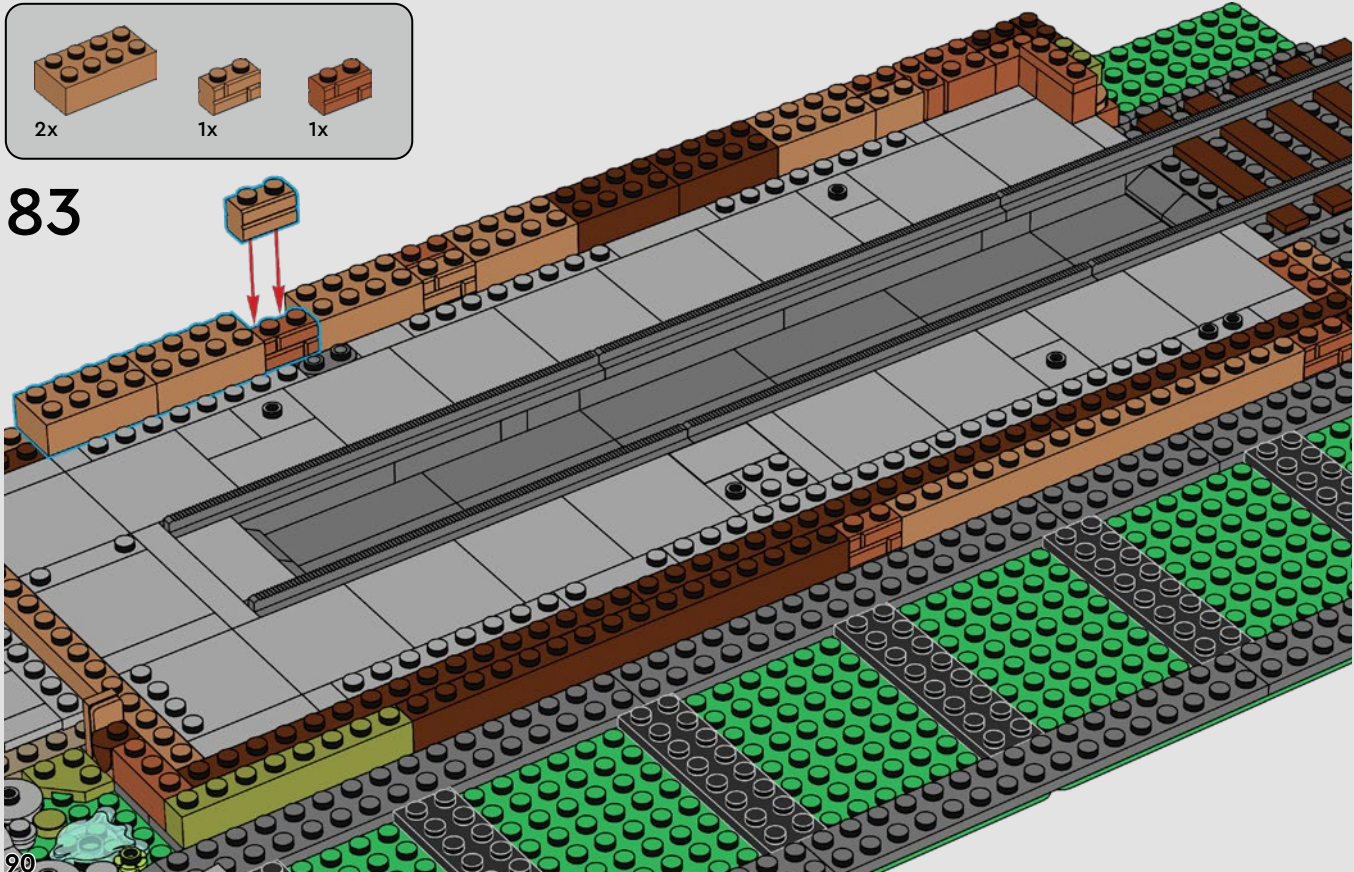

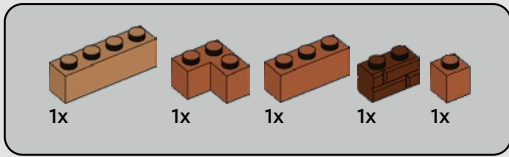

84

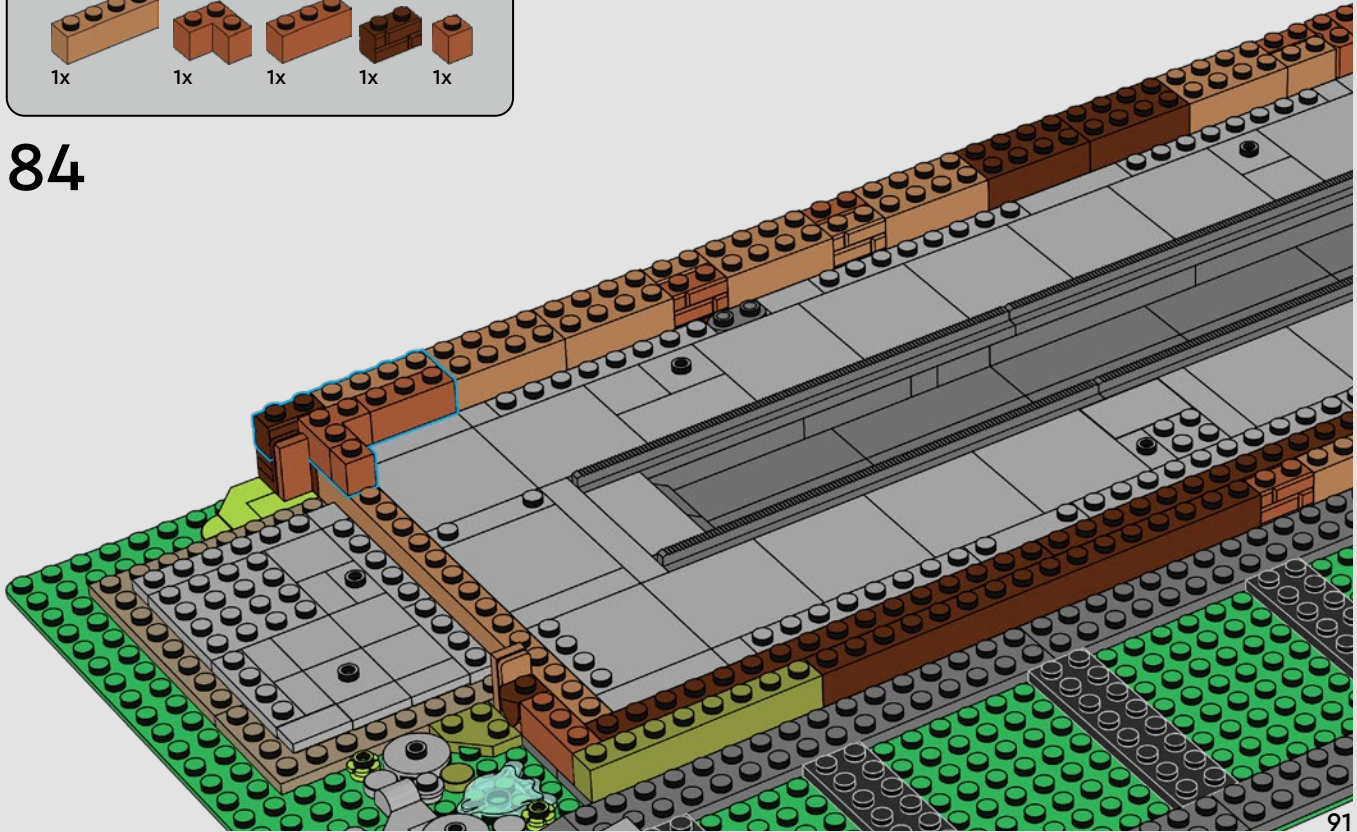

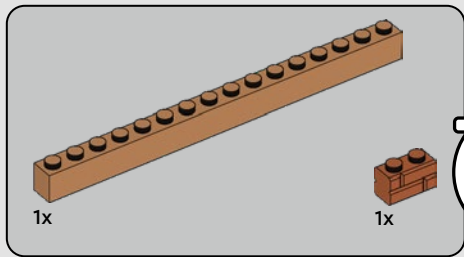

85

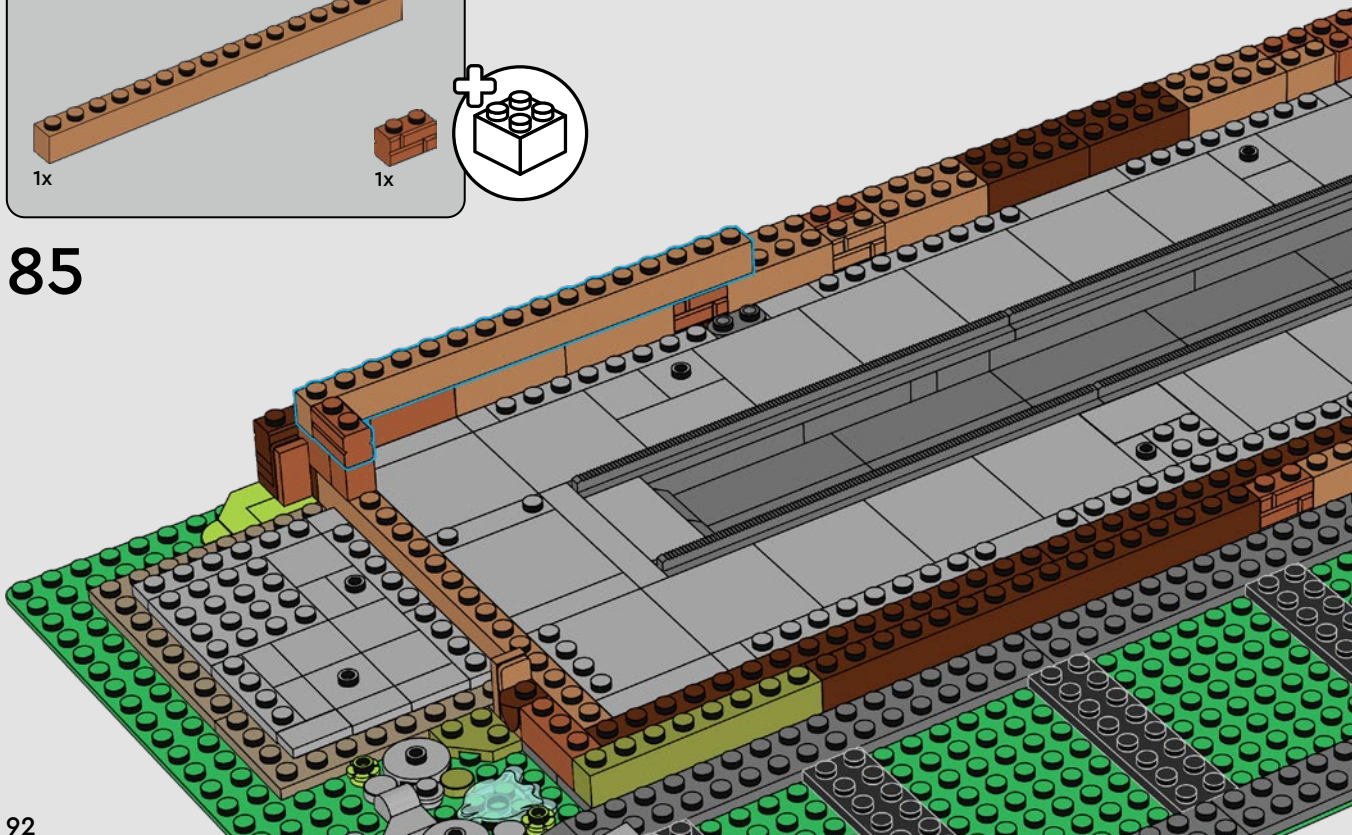

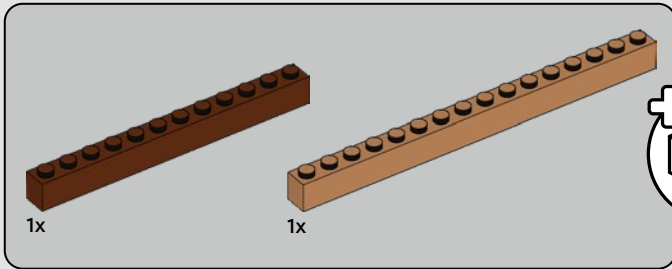

86

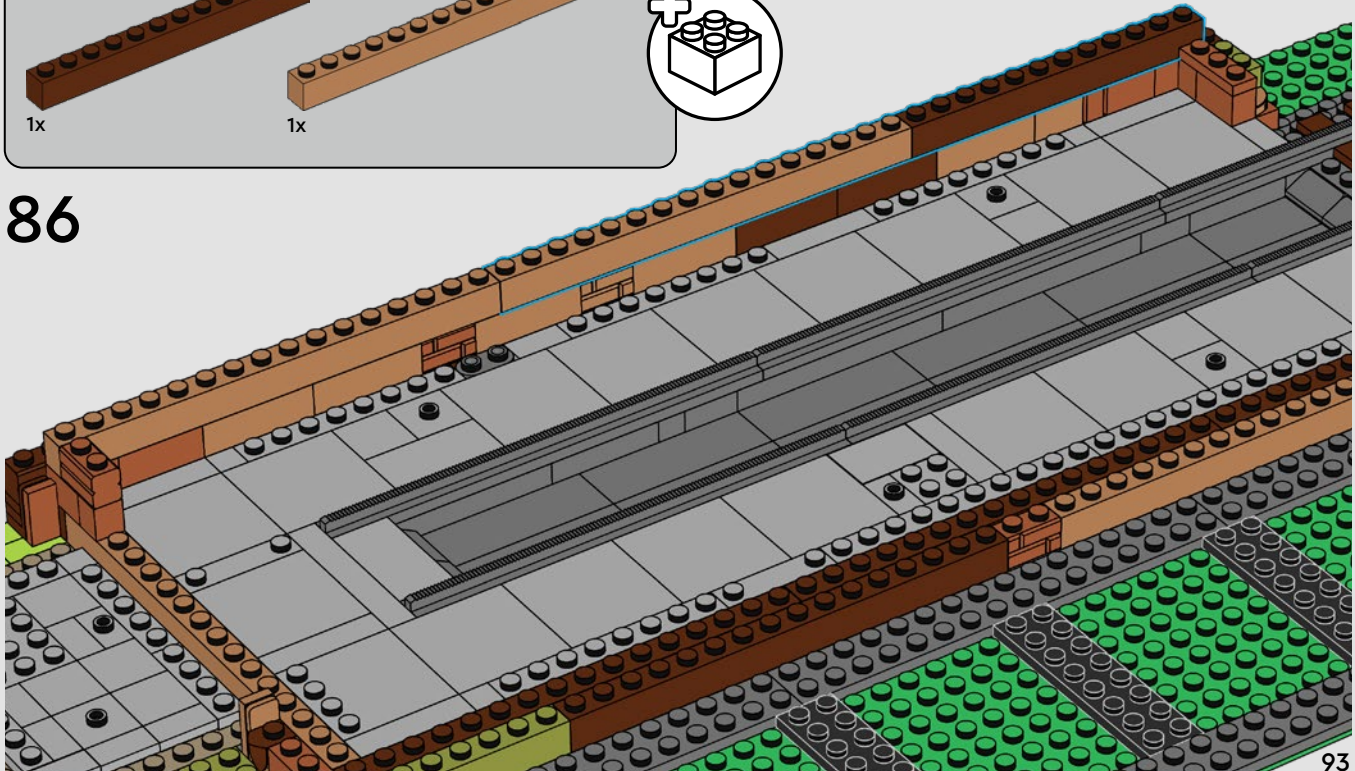

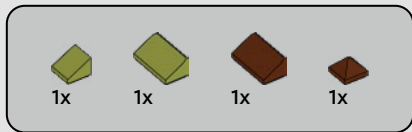

87

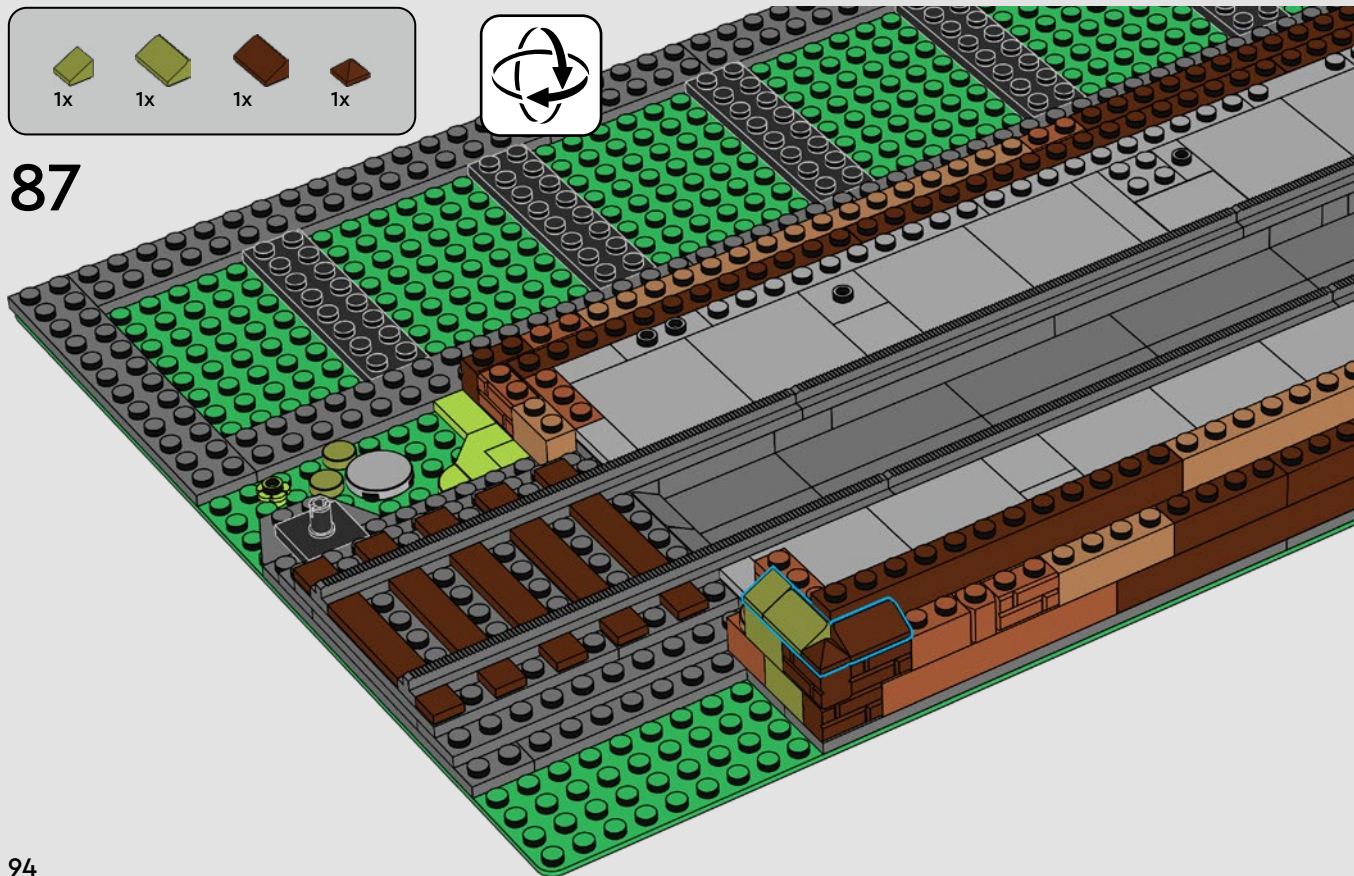



2x

88

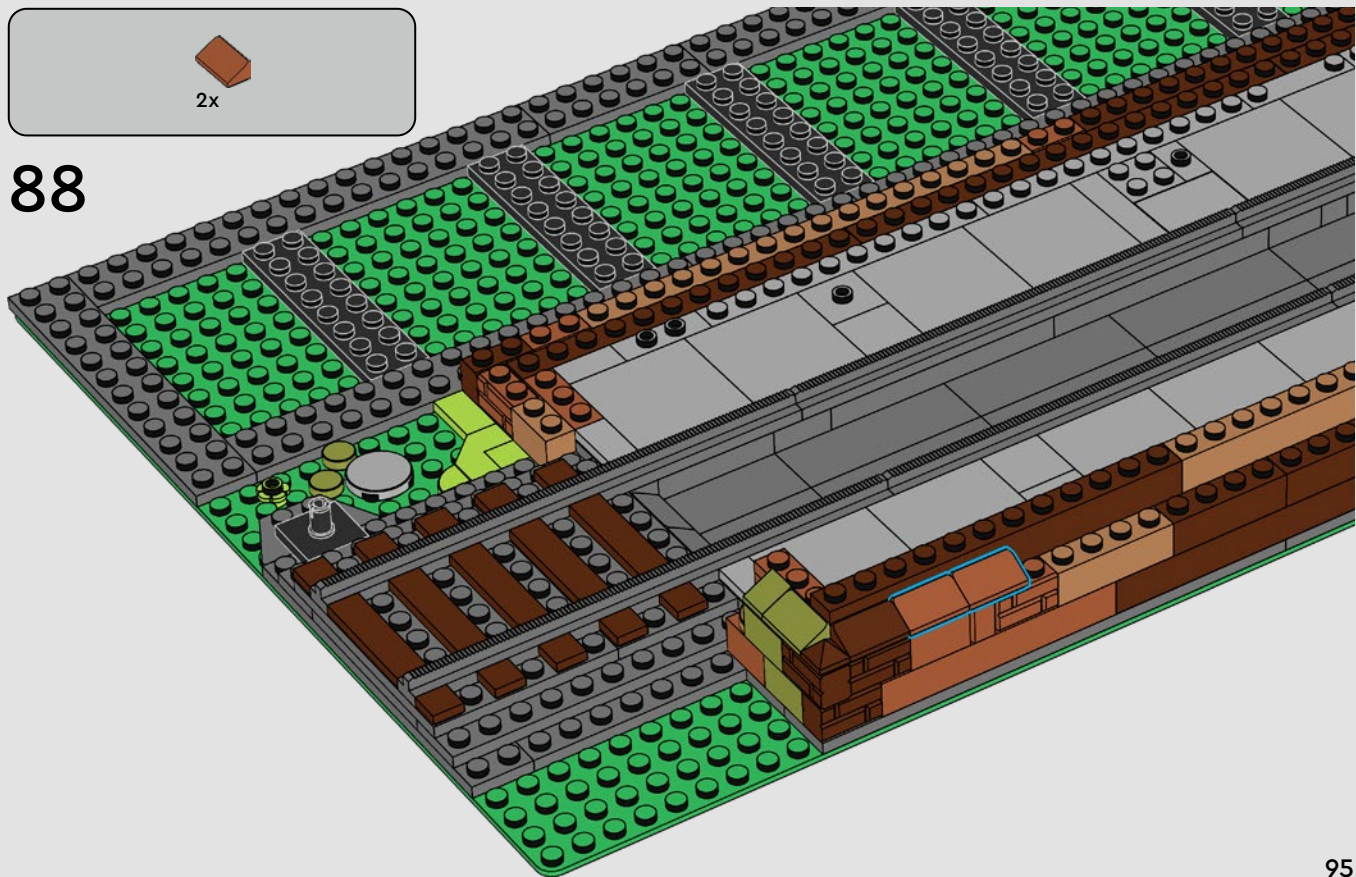

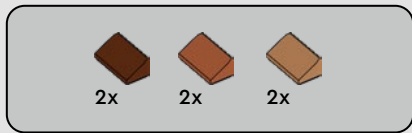

89

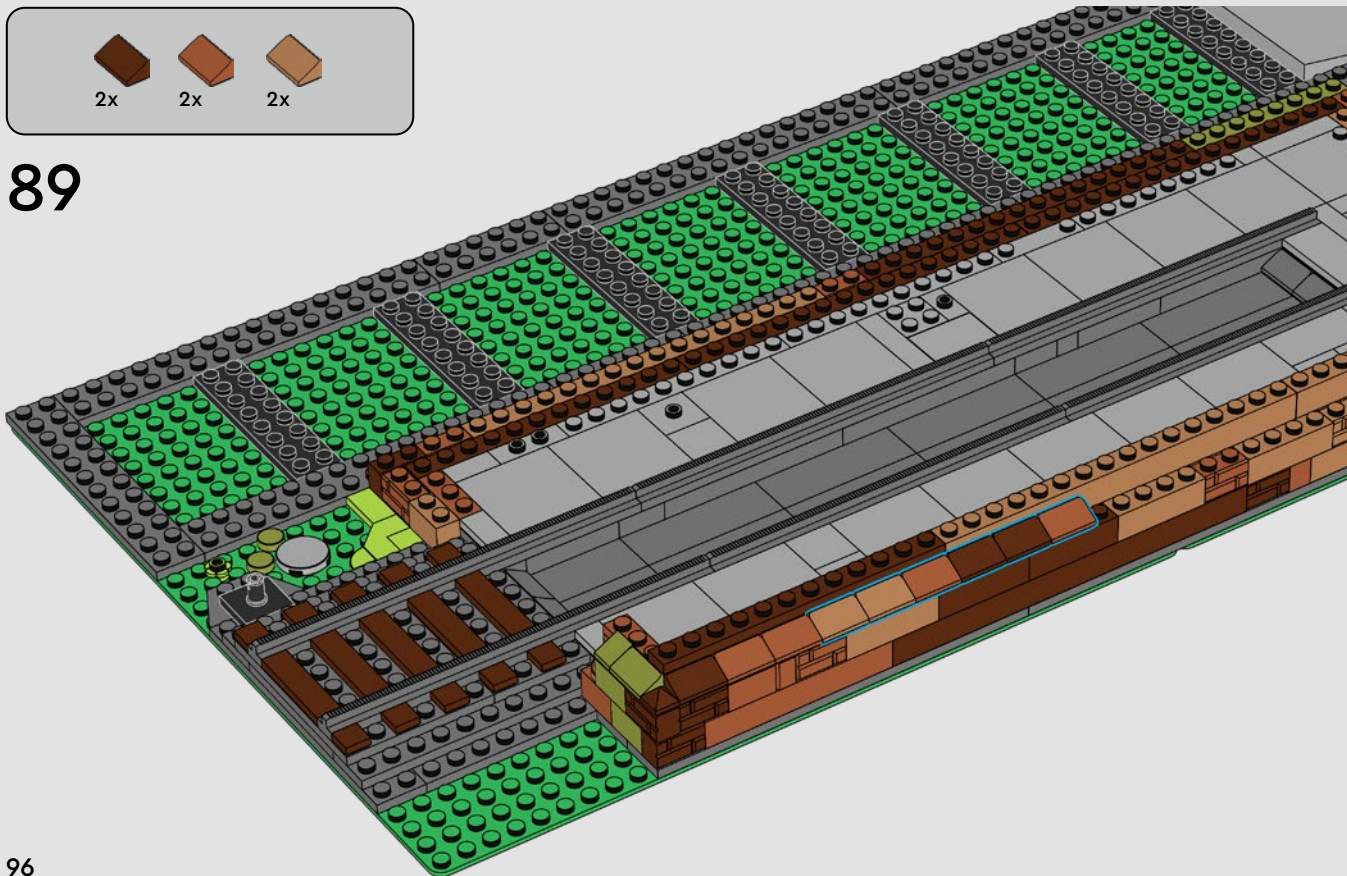

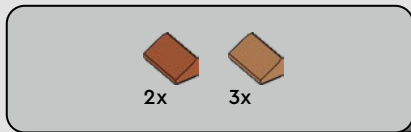

90

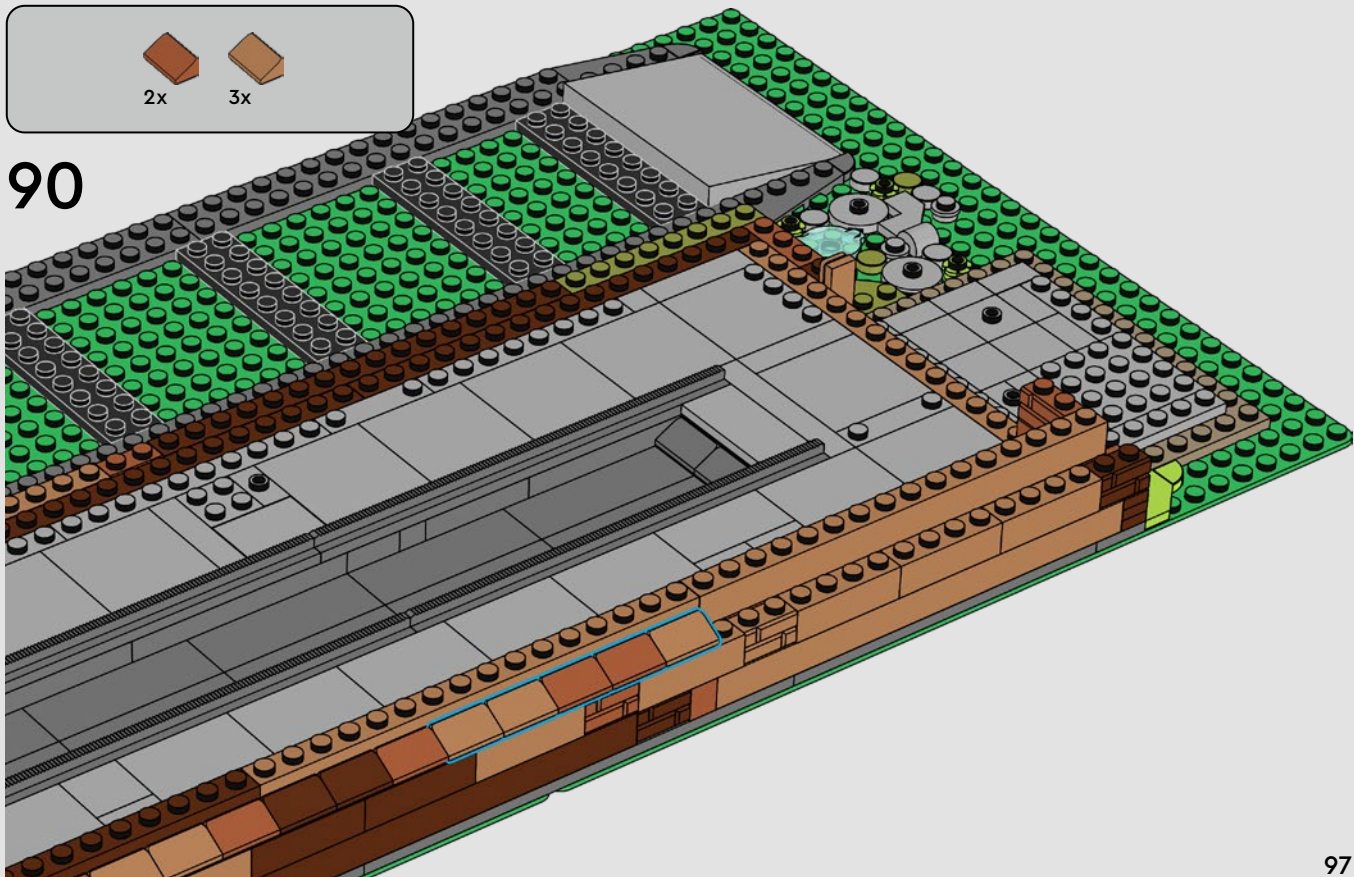



5x

91

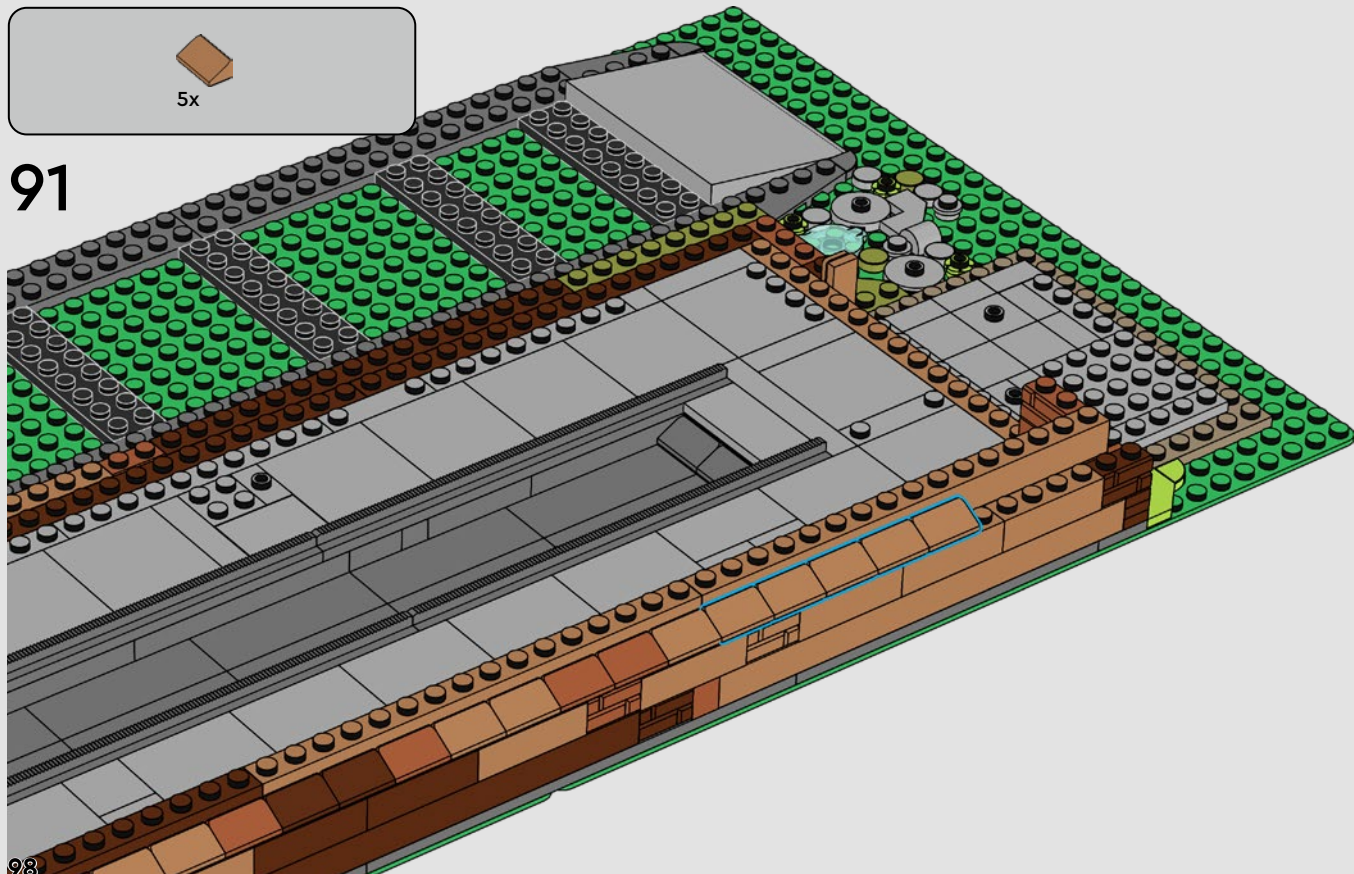

98

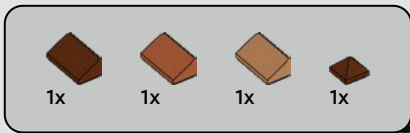

92

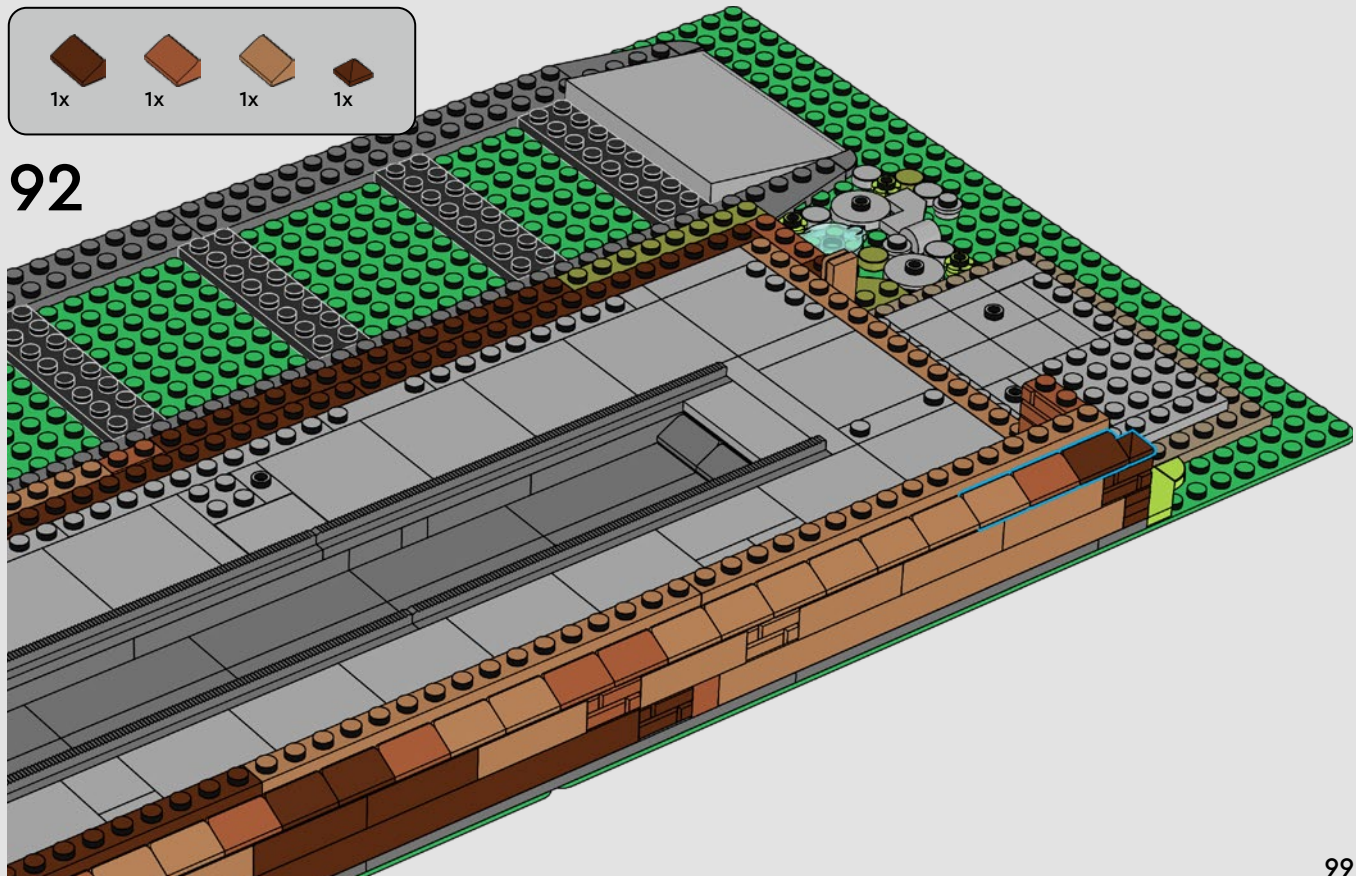



93

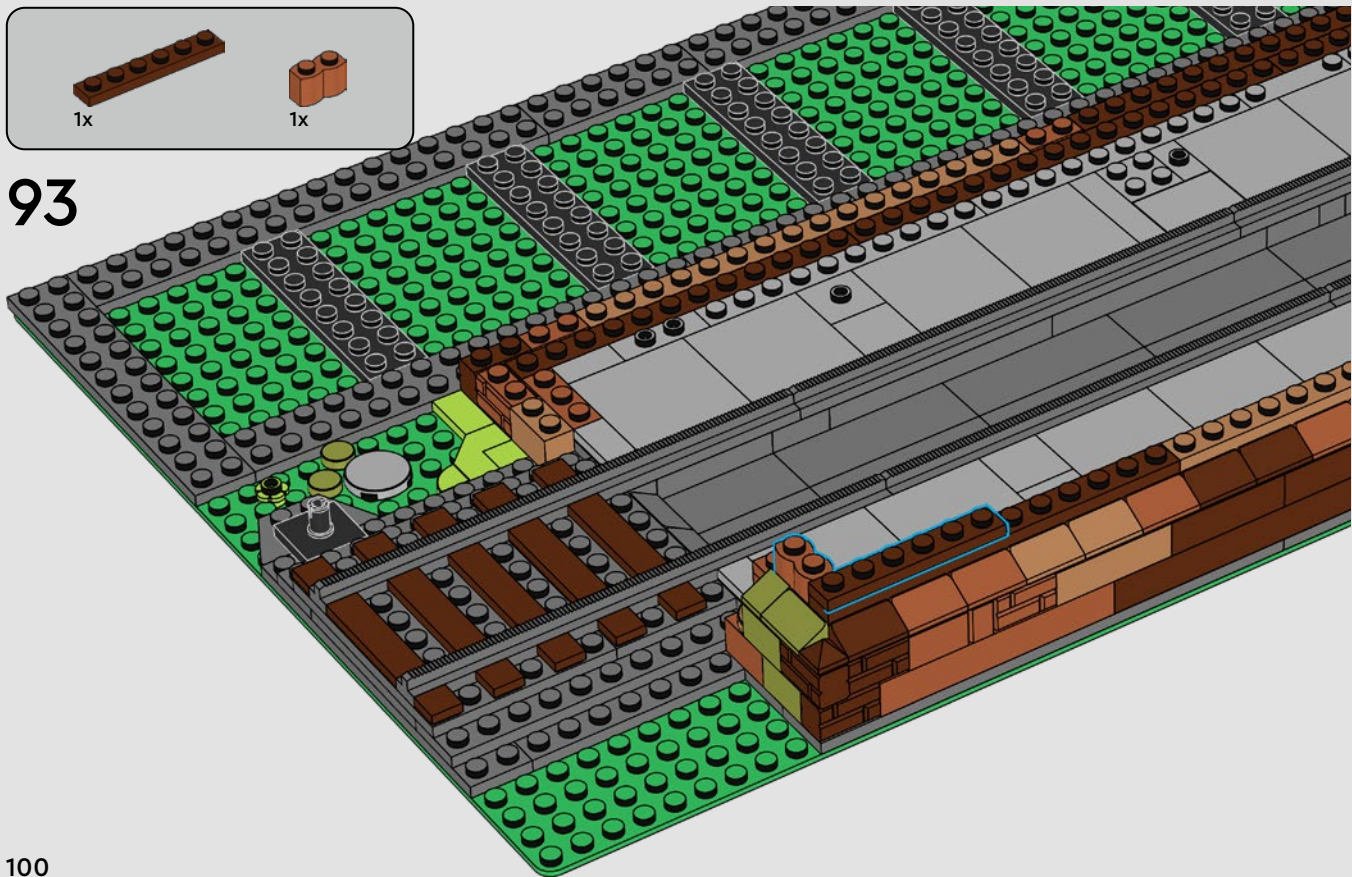



1x



1x

94

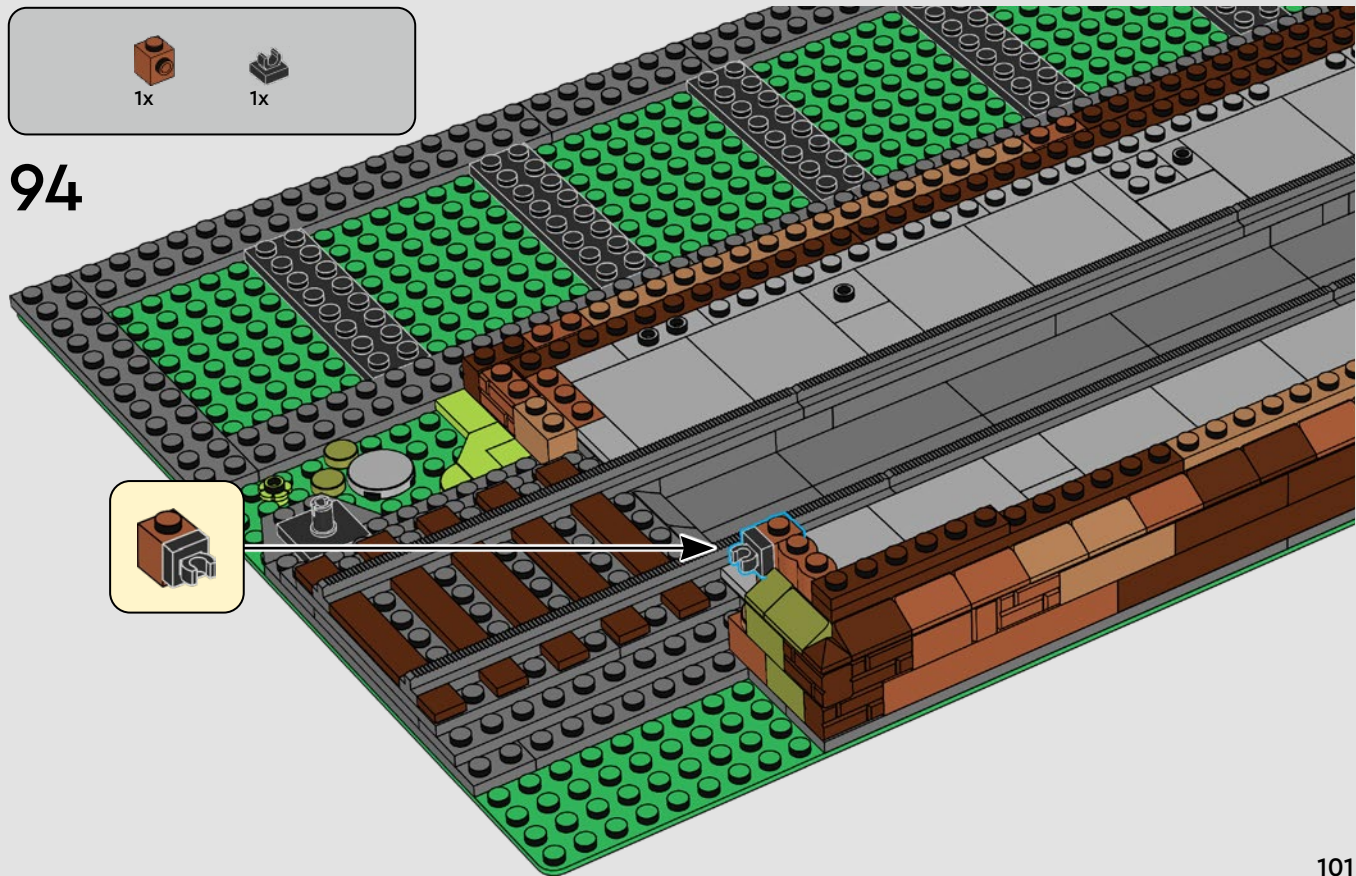

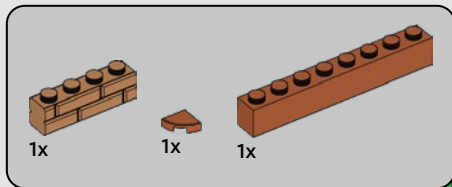

95

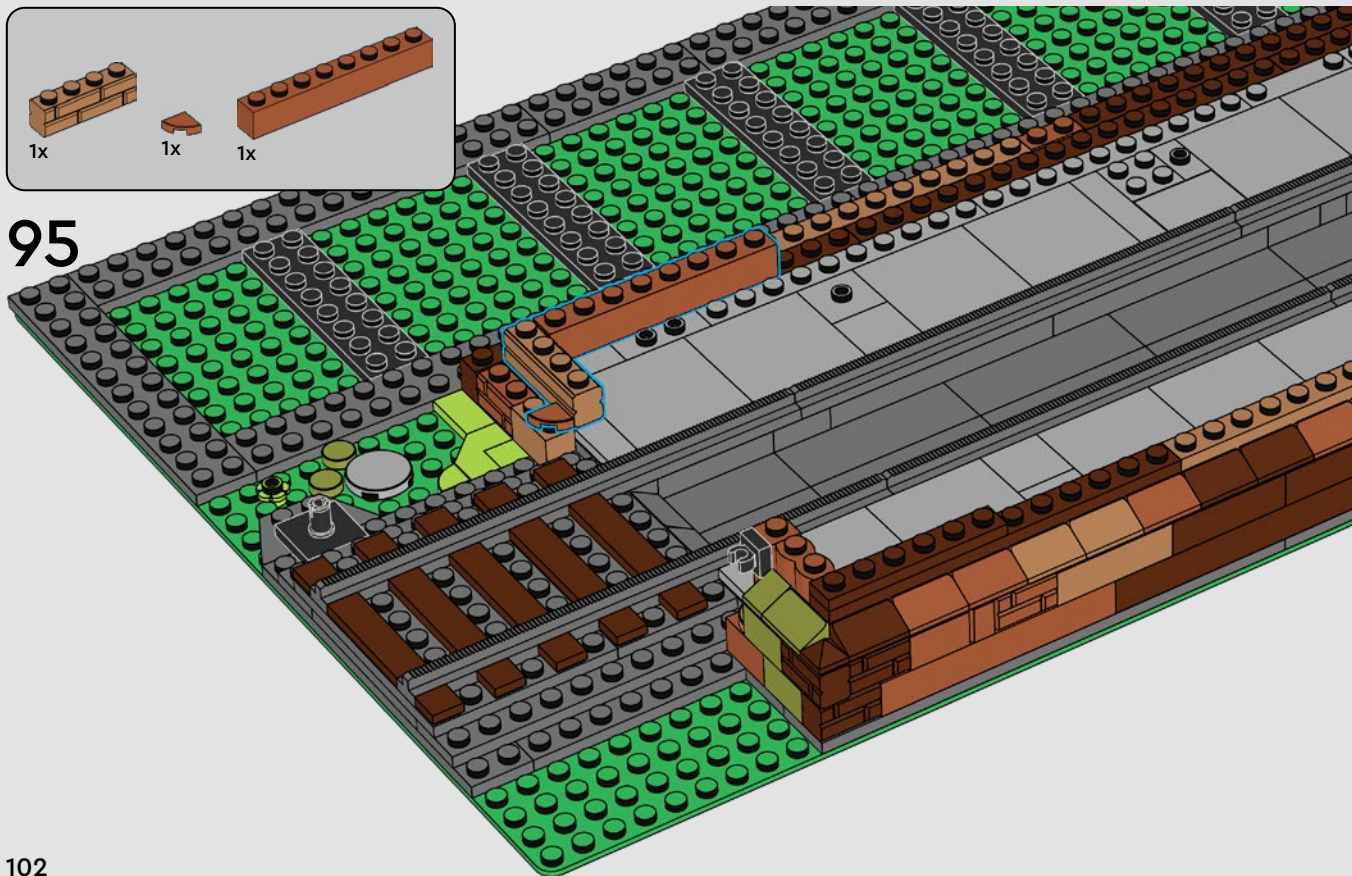

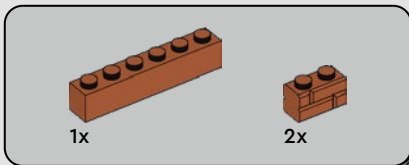

96

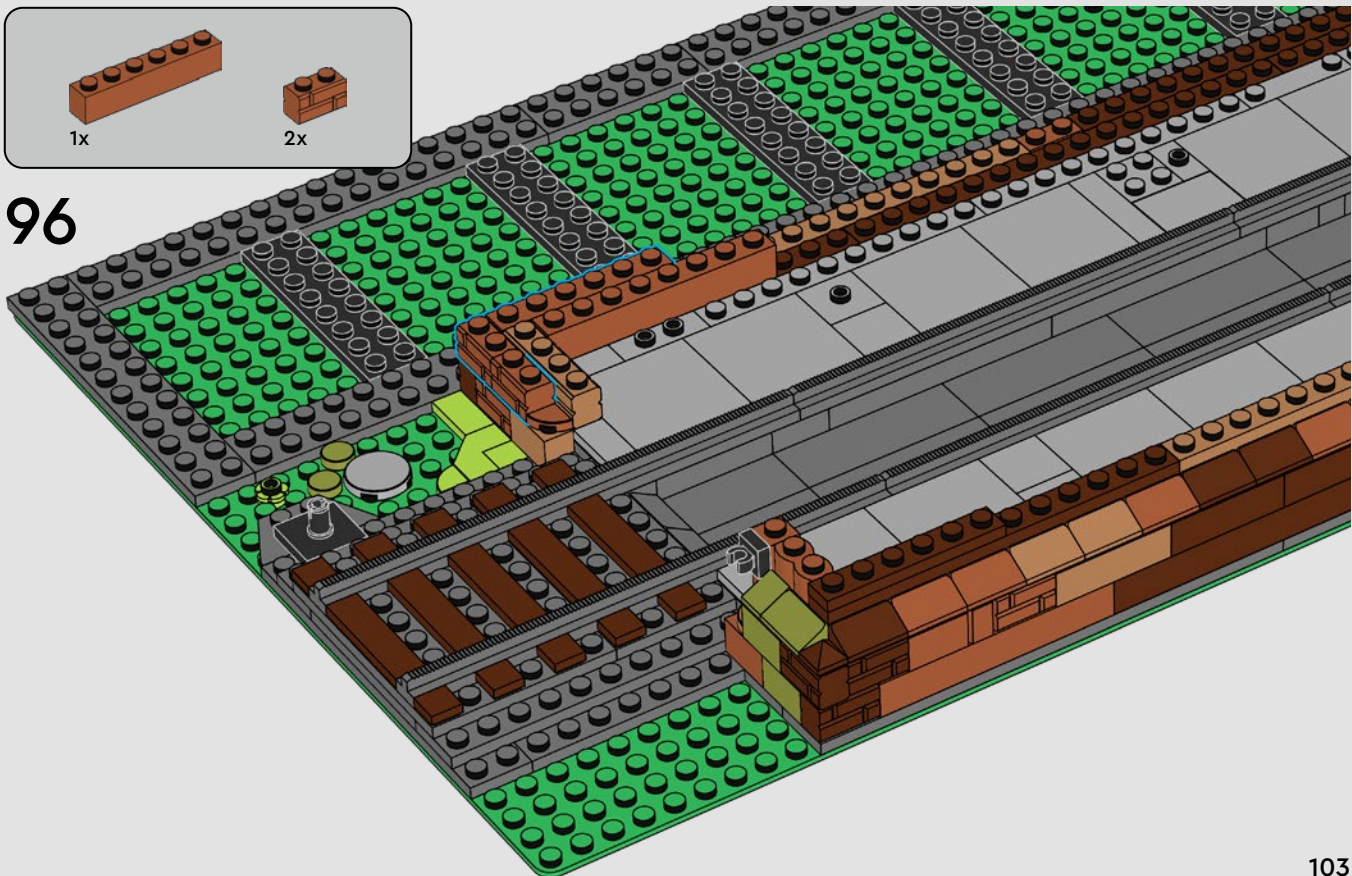

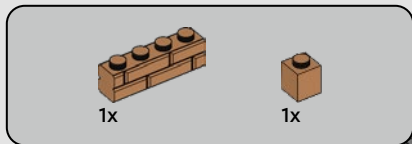

97

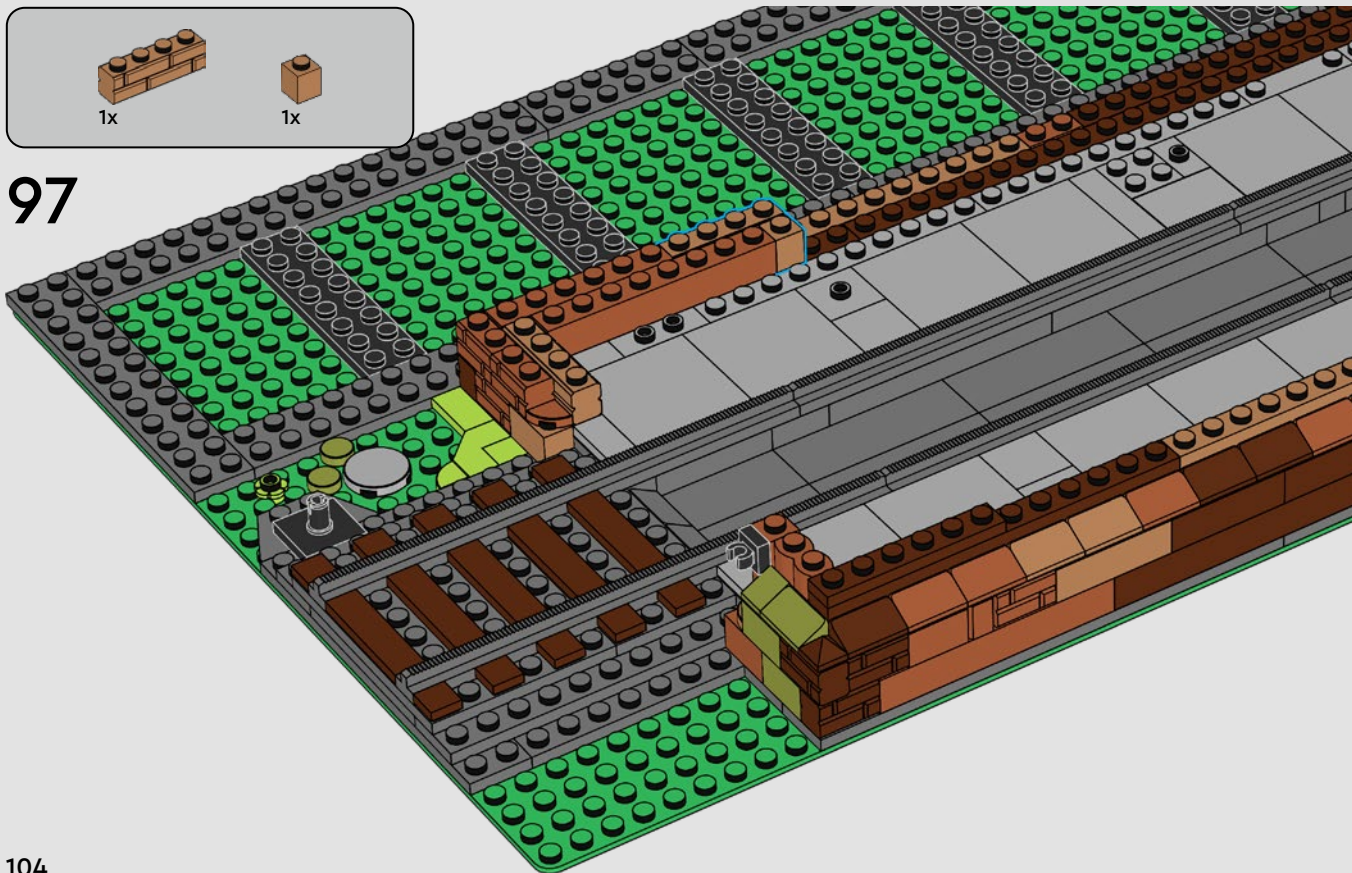



2x

98

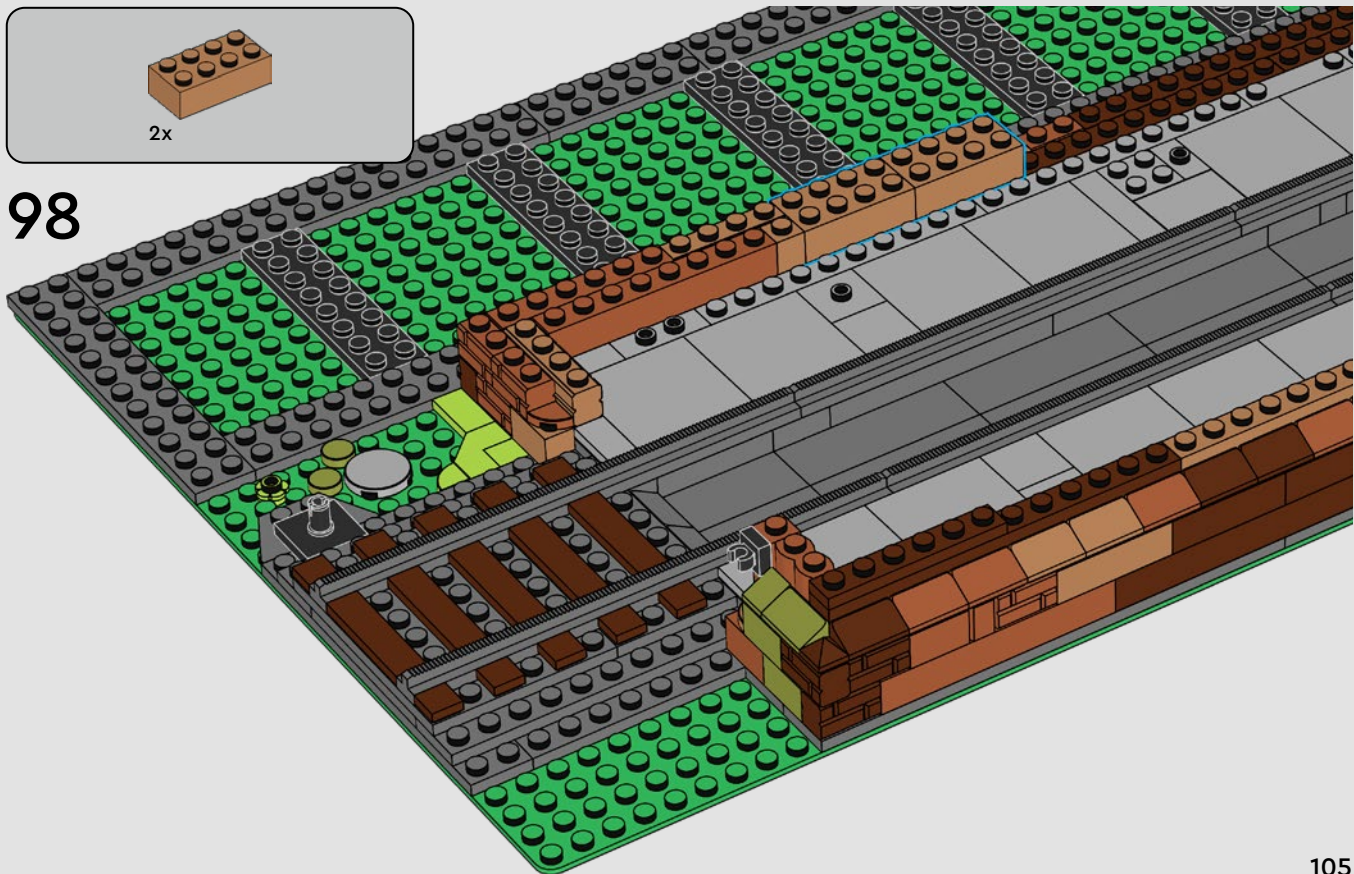

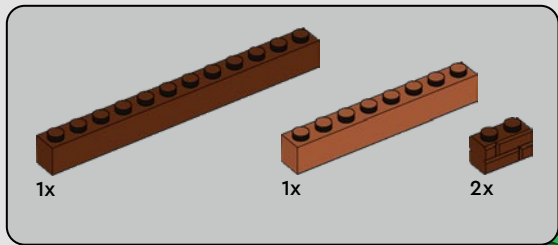

99

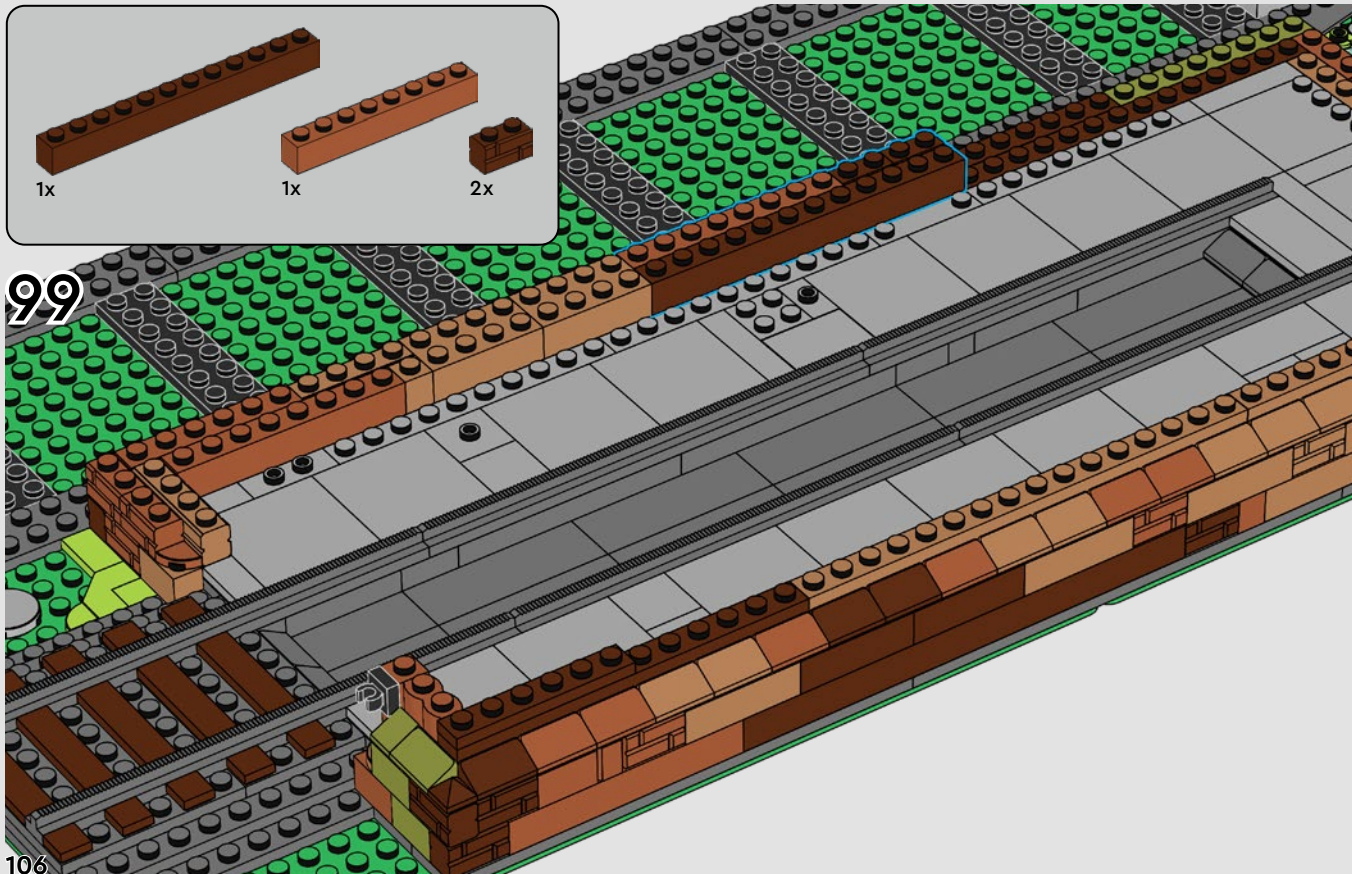

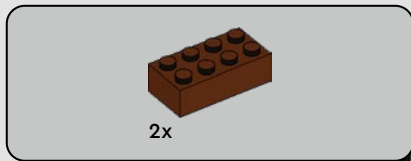

100

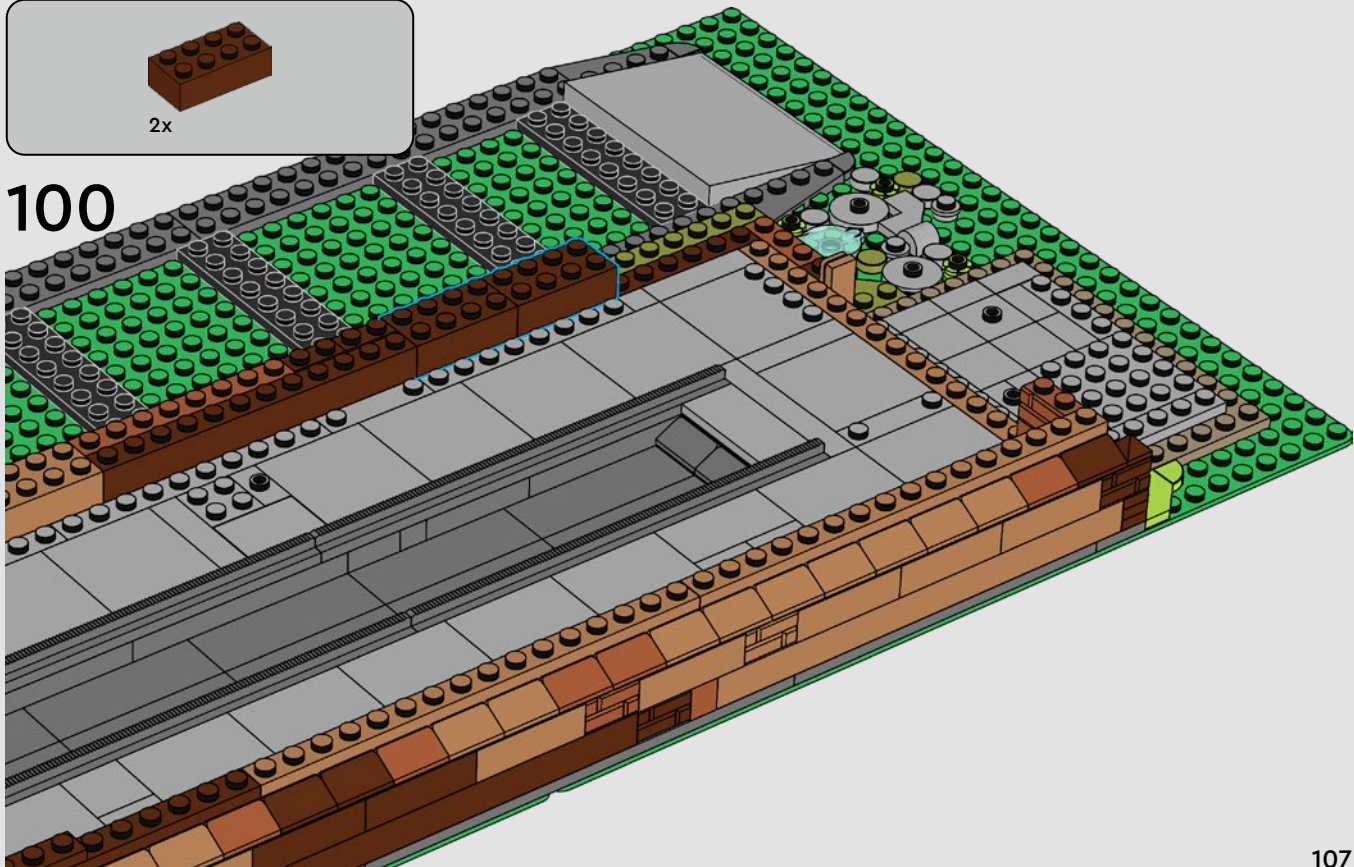

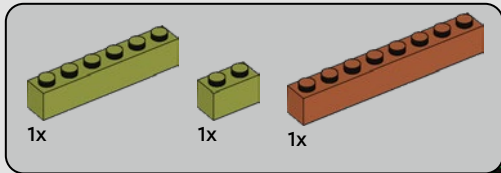

101

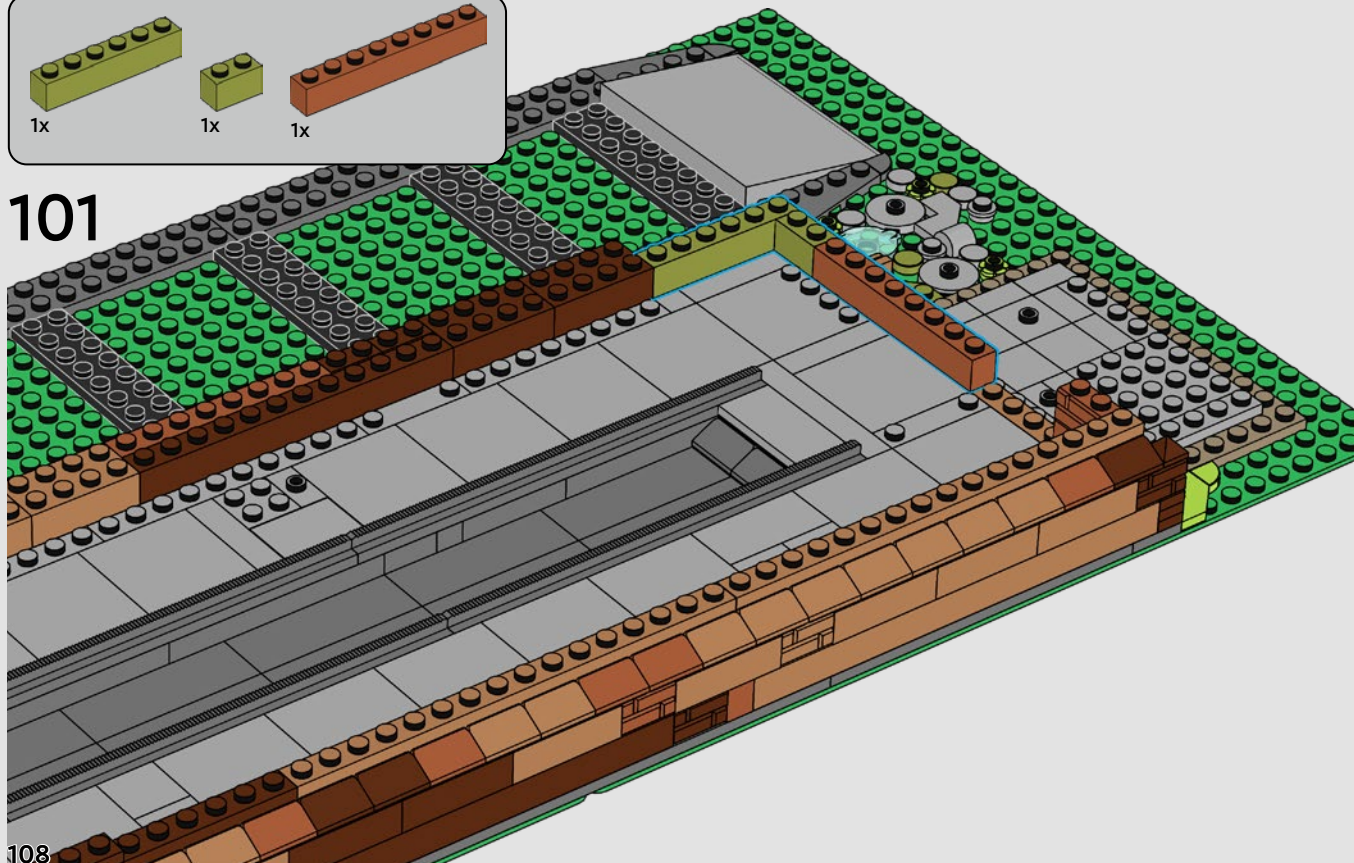

108

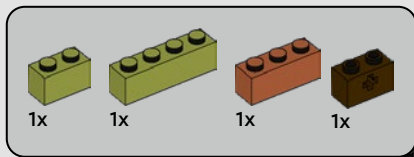

102

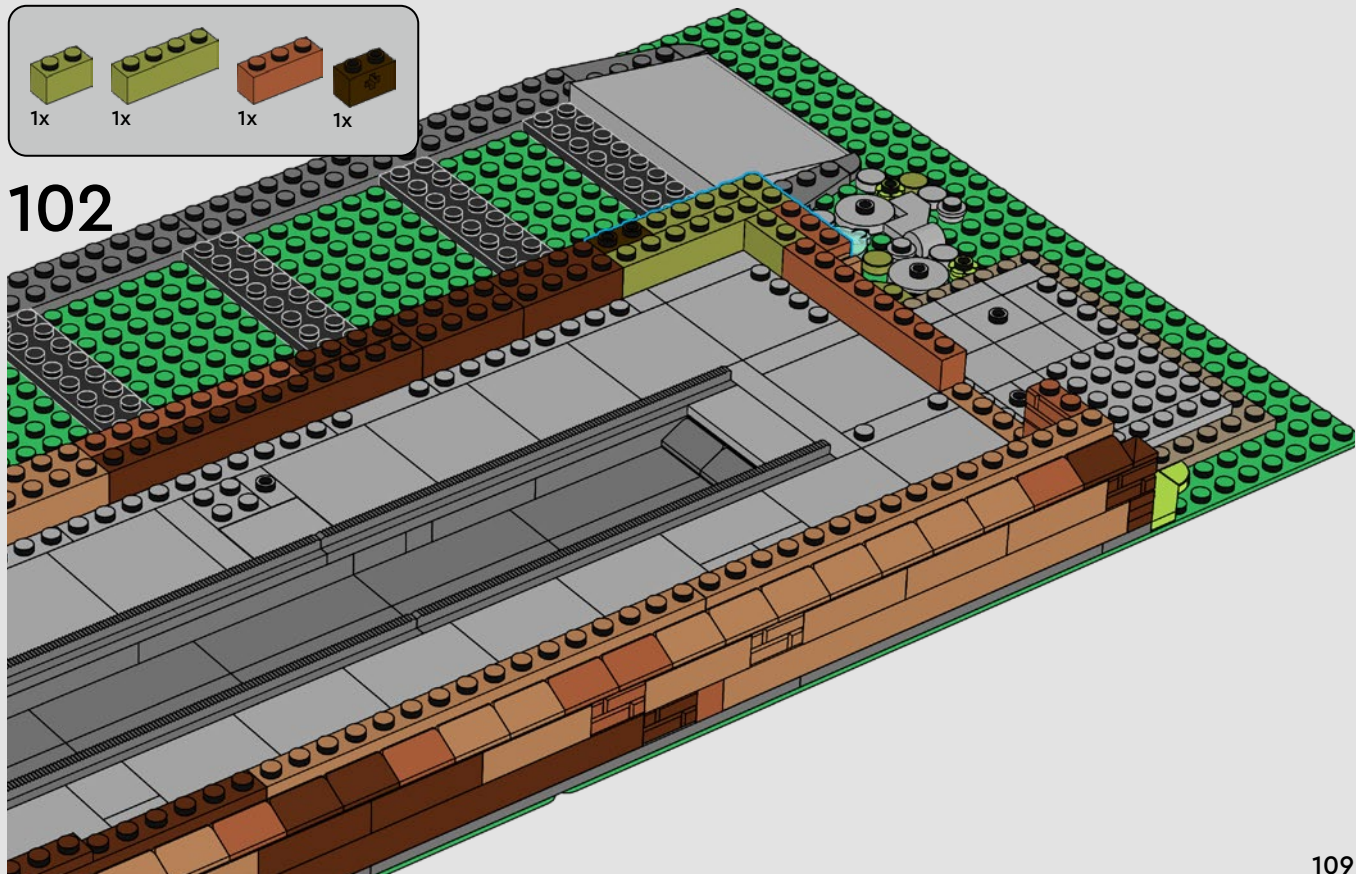

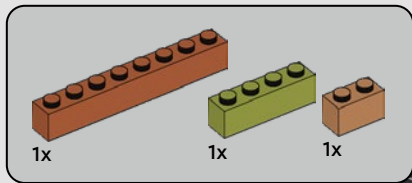

103

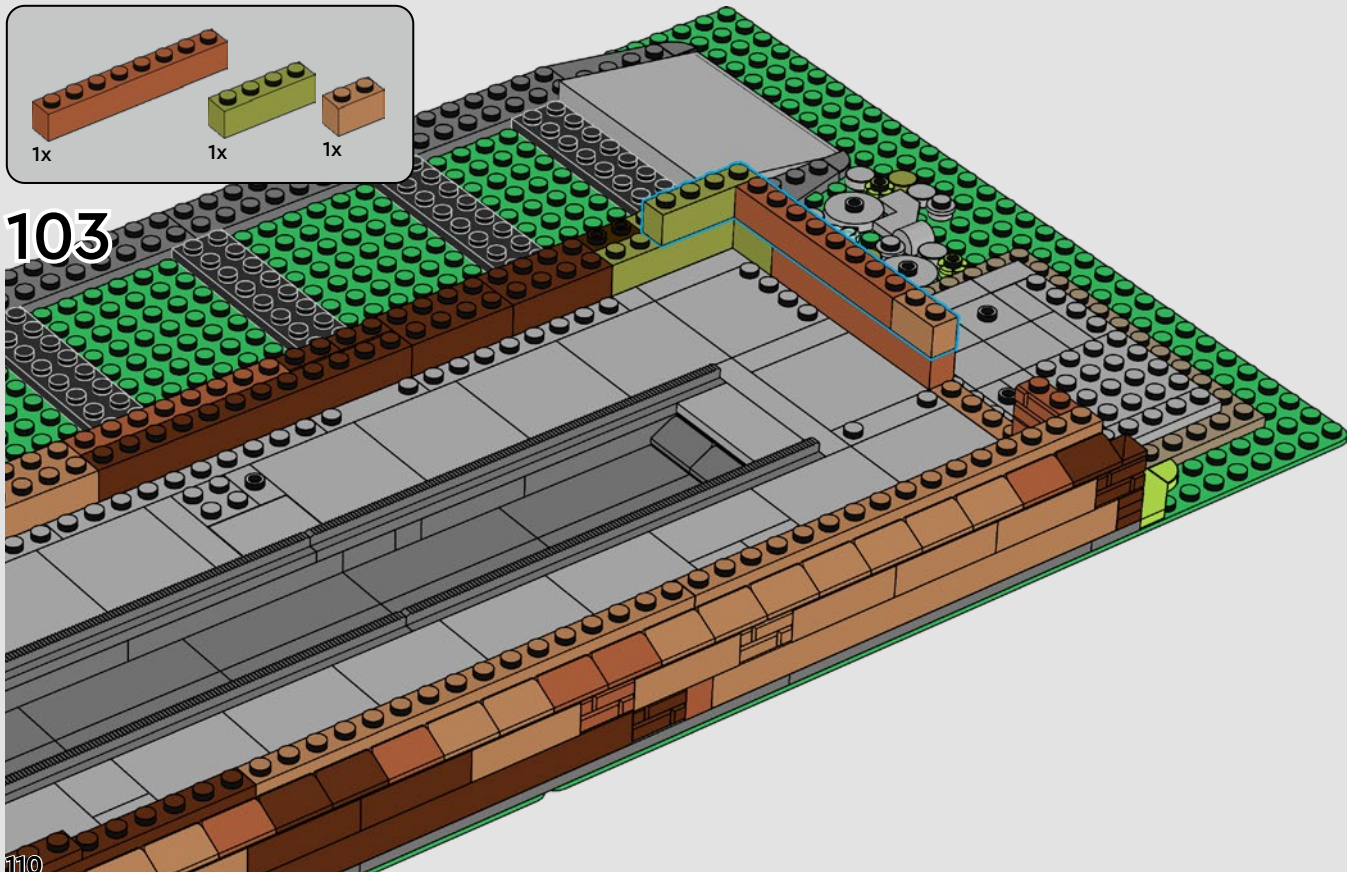

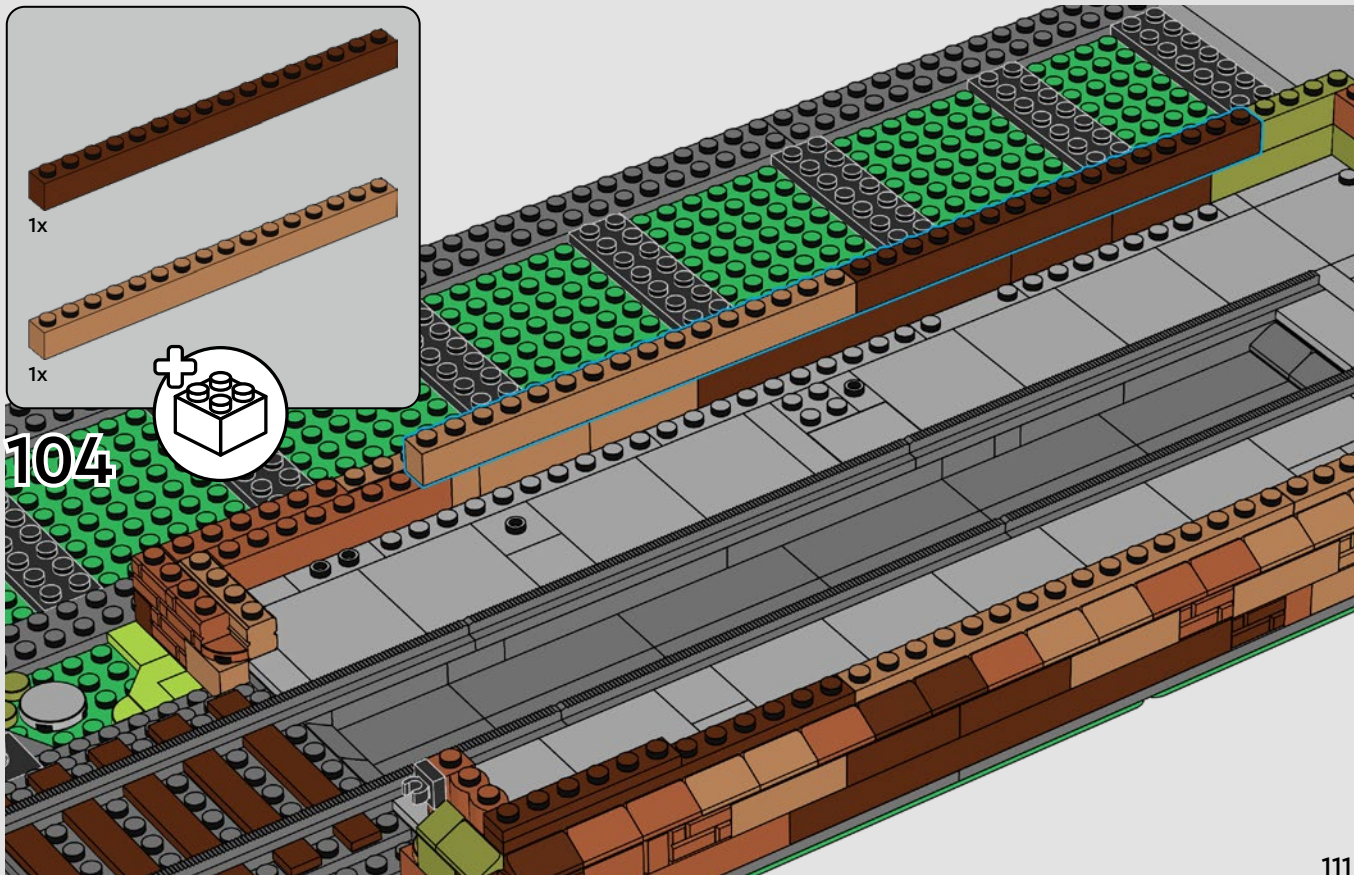

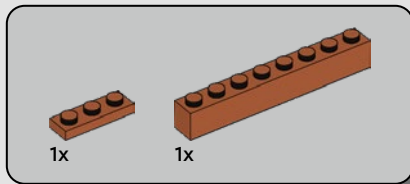

105

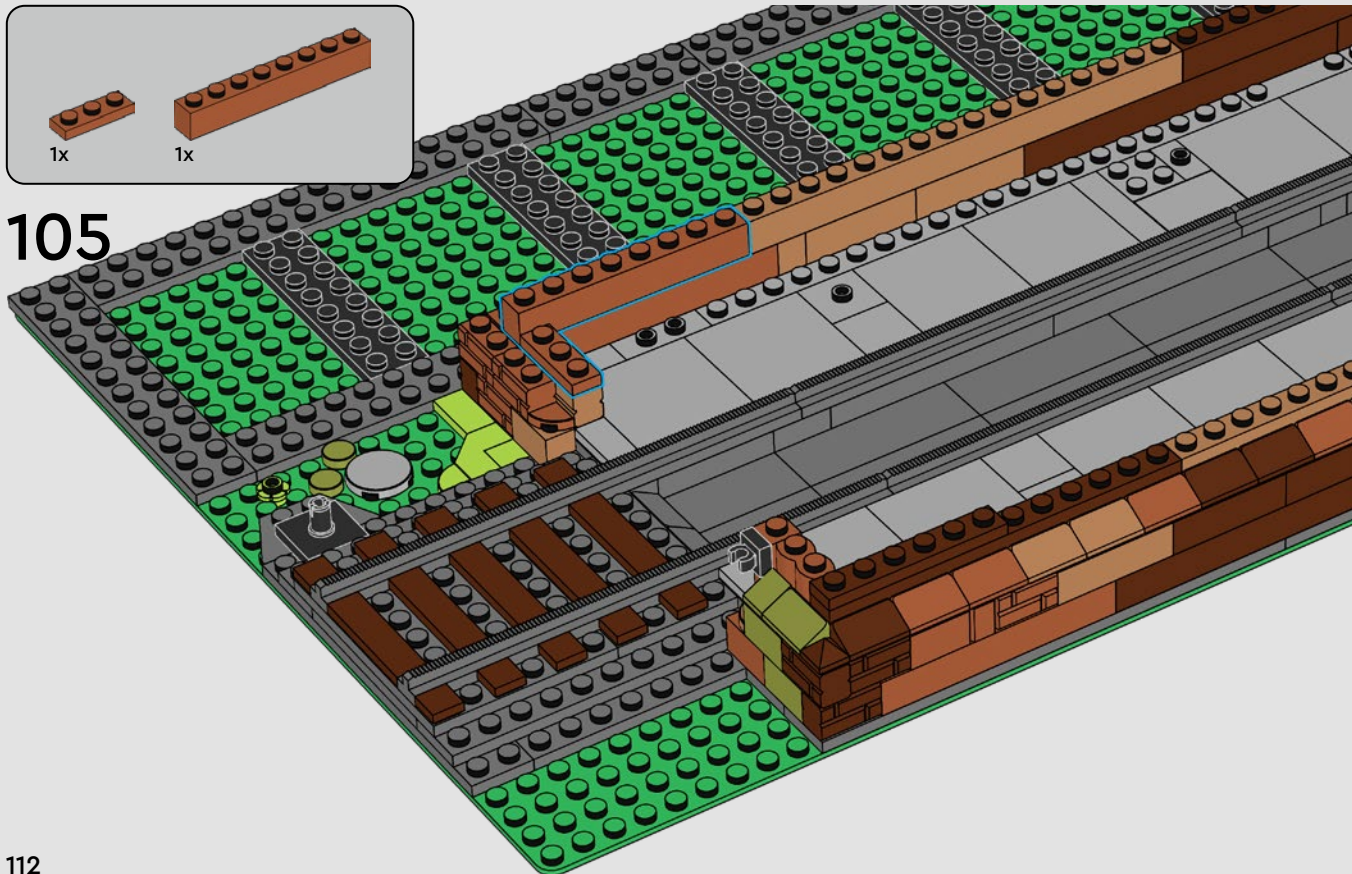

3x
1x
1x

106

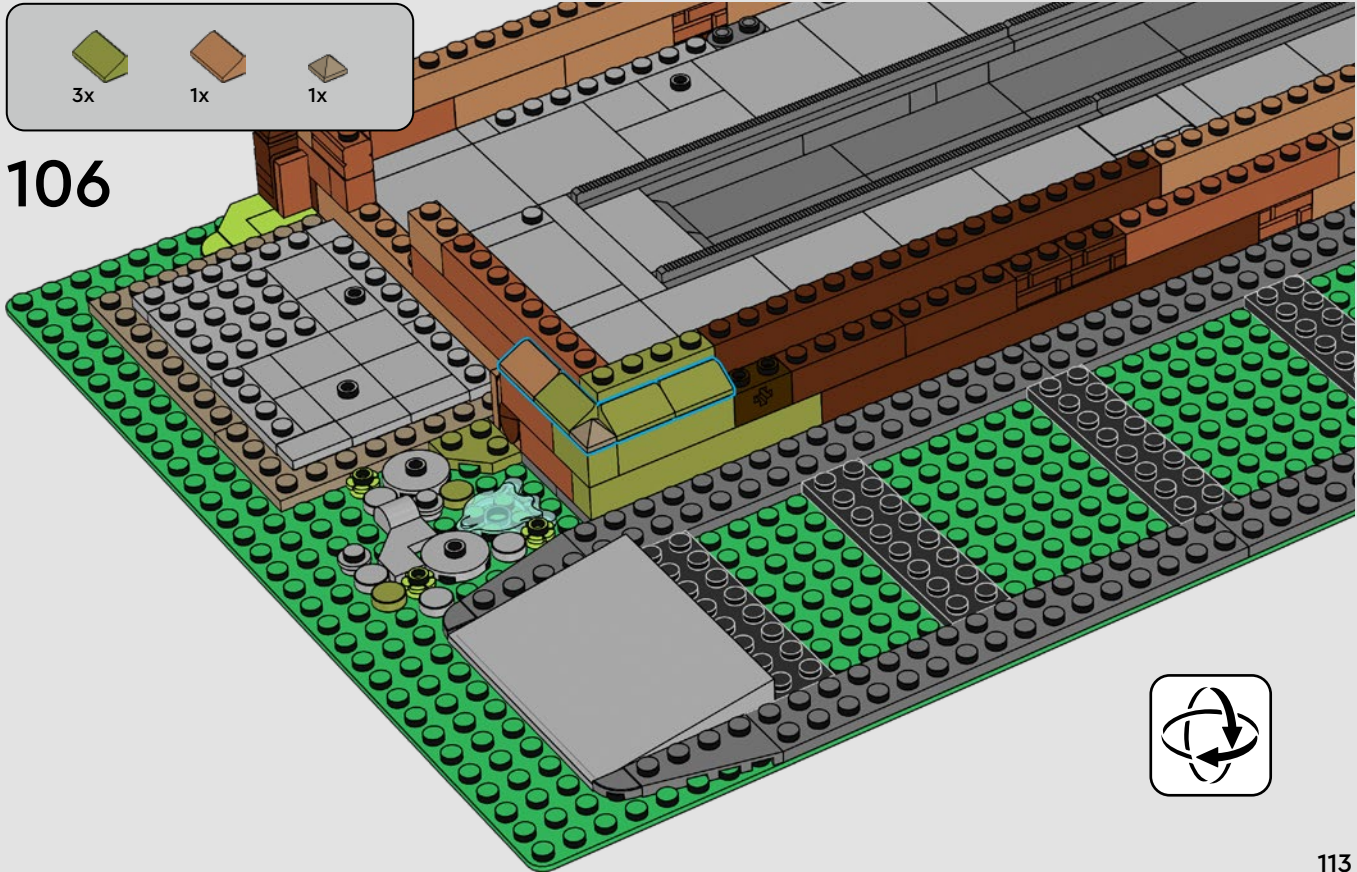



6x

107

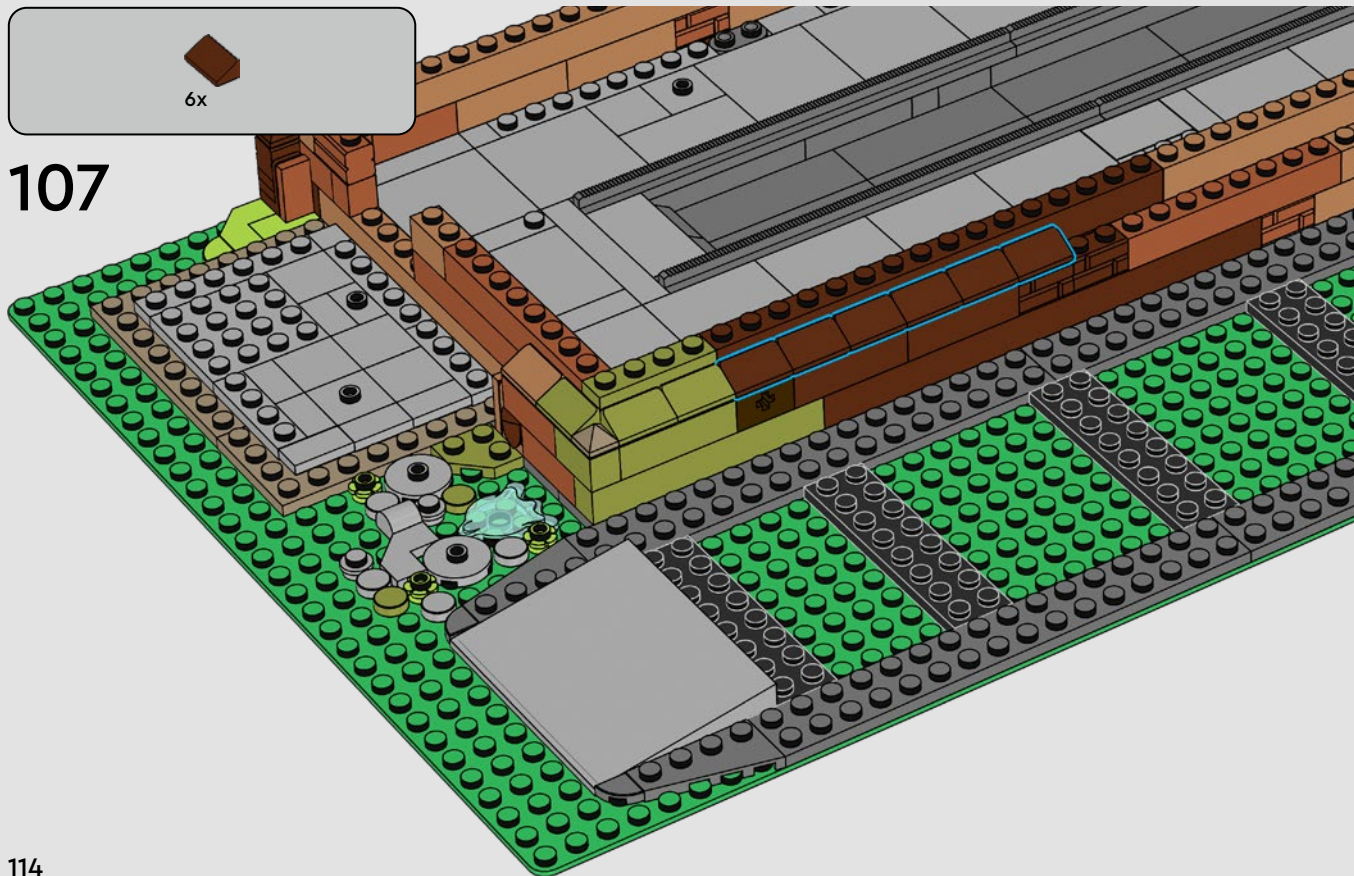

2x 2x 1x

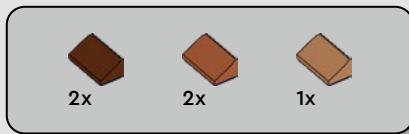

108

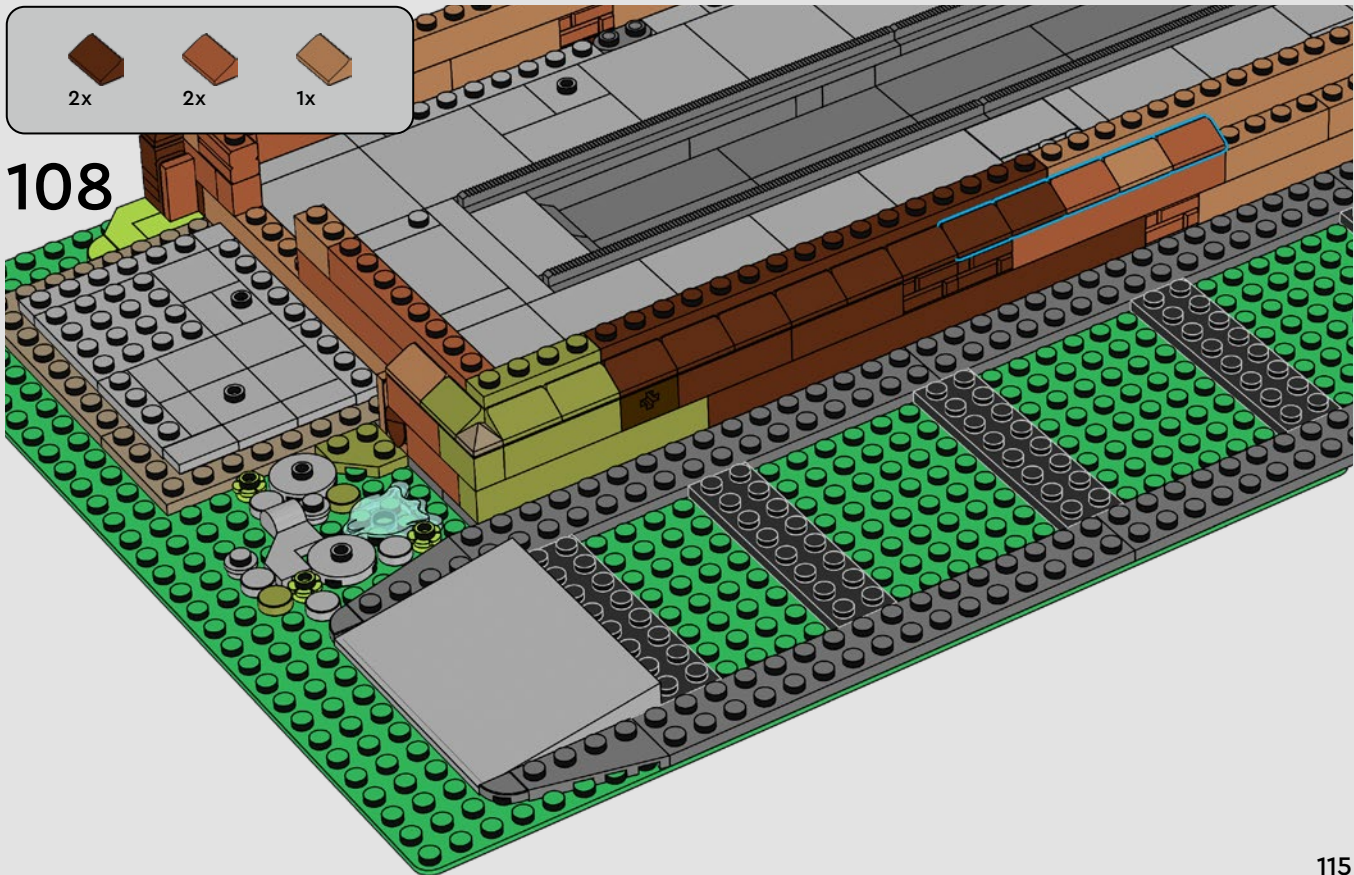

1x 4x

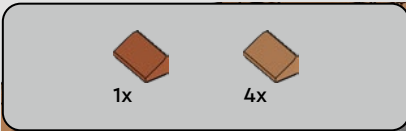

109

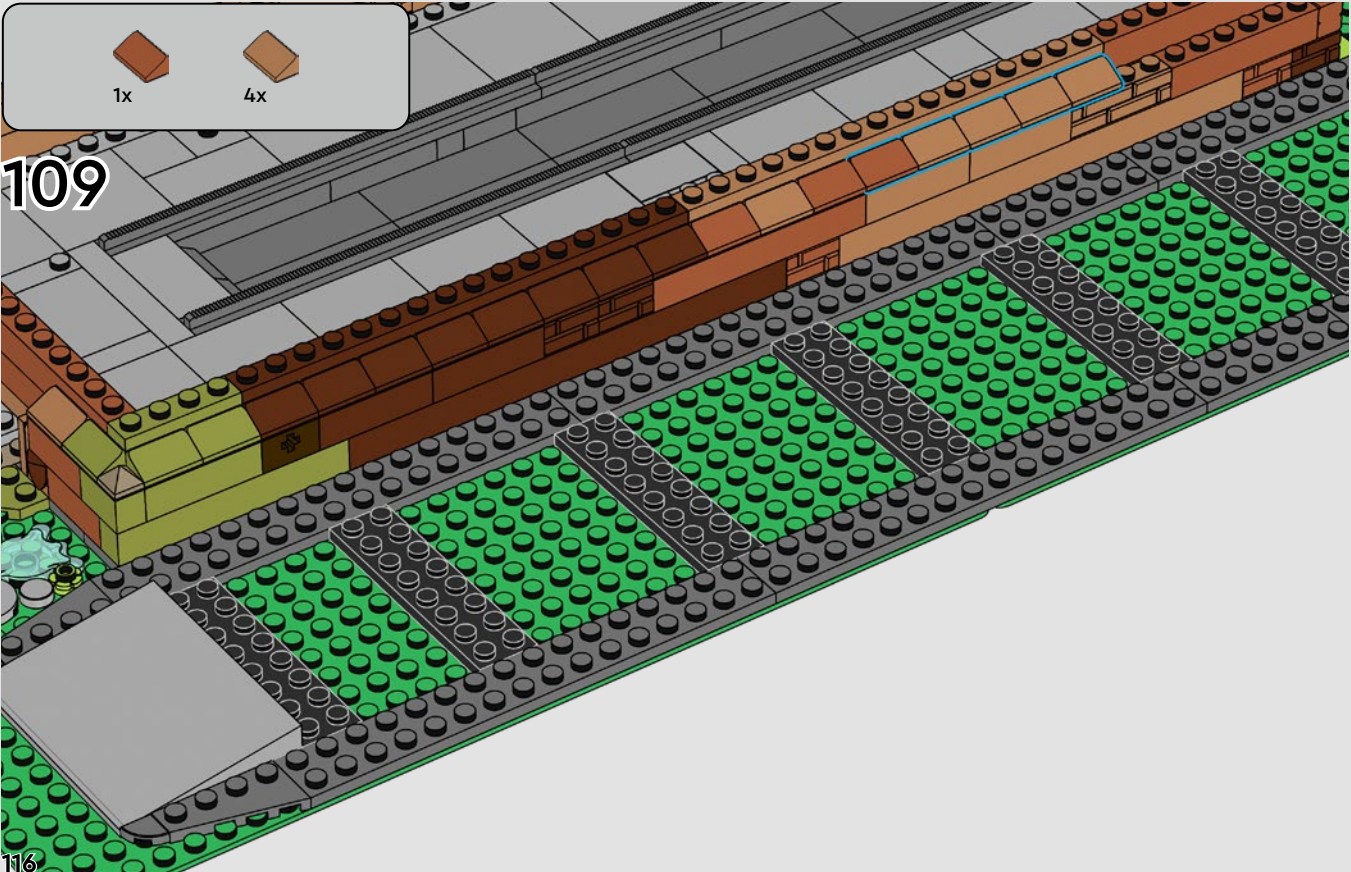



1x



1x



4x



1x

110

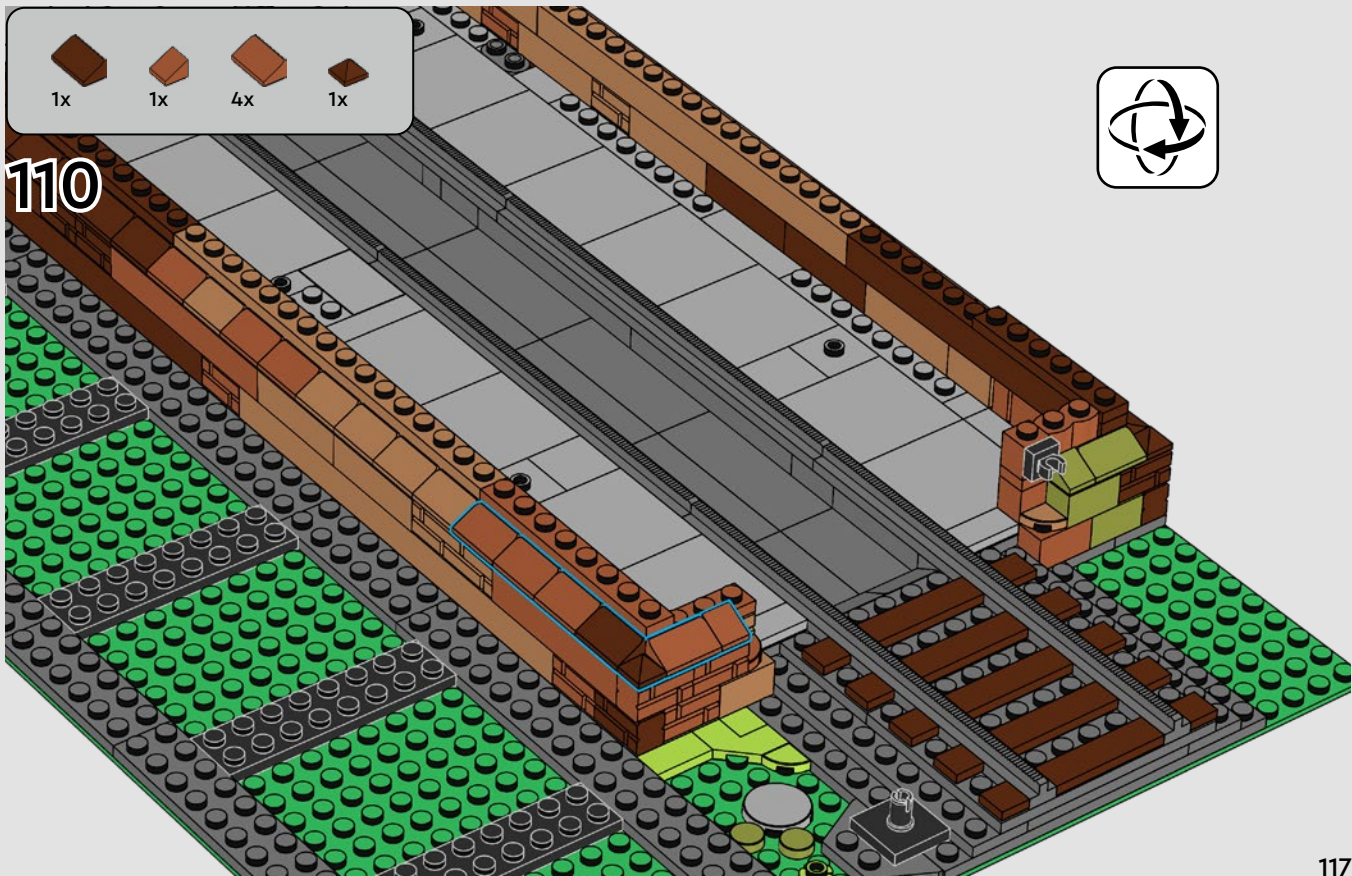
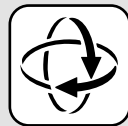

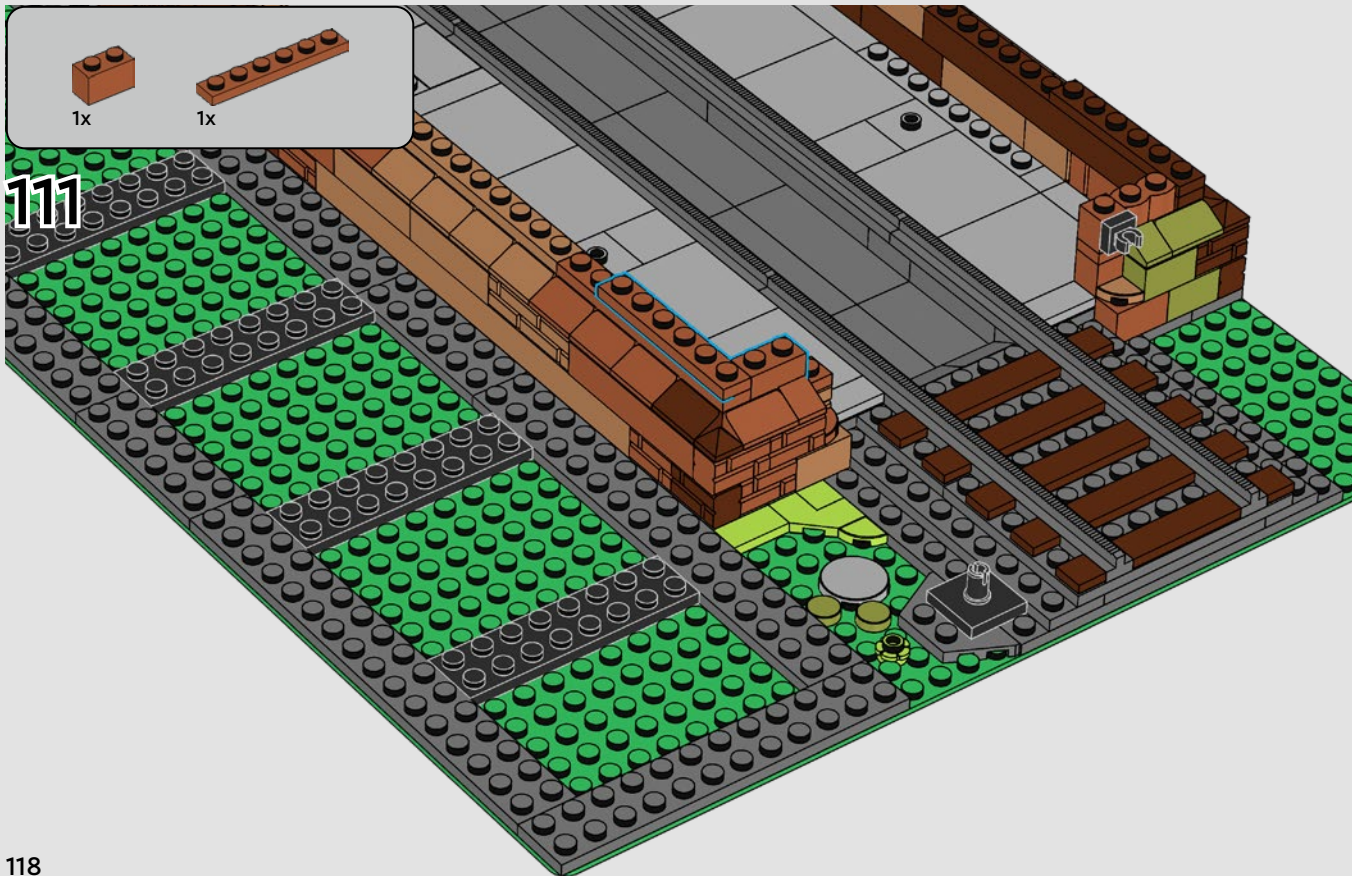

1x  1x 

112

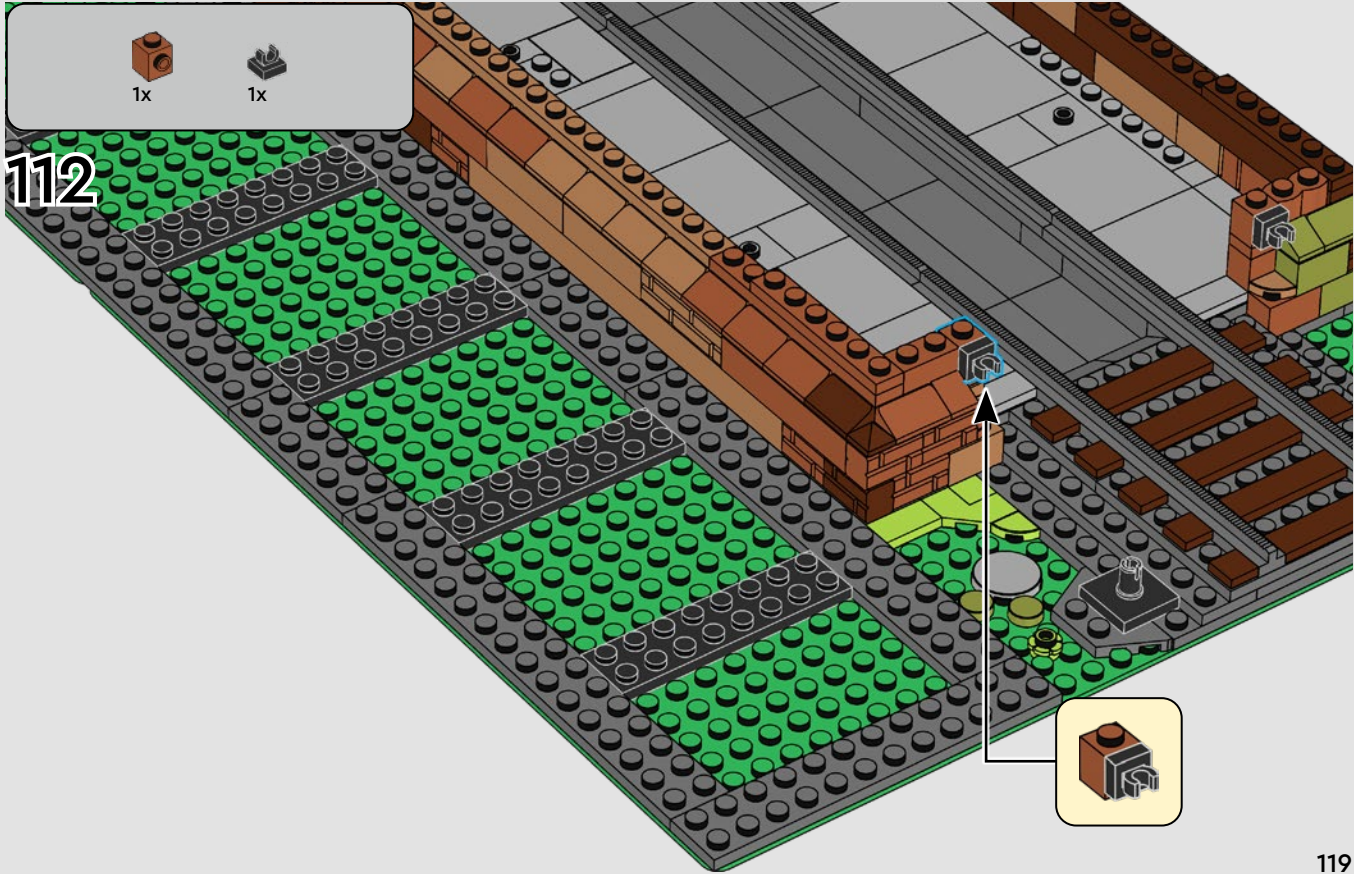

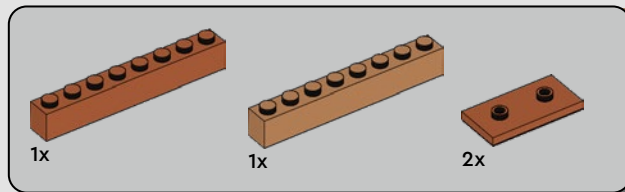

113

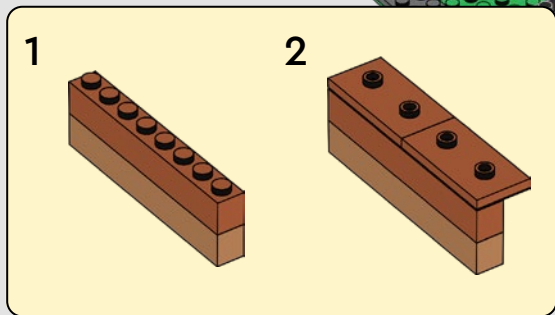

120

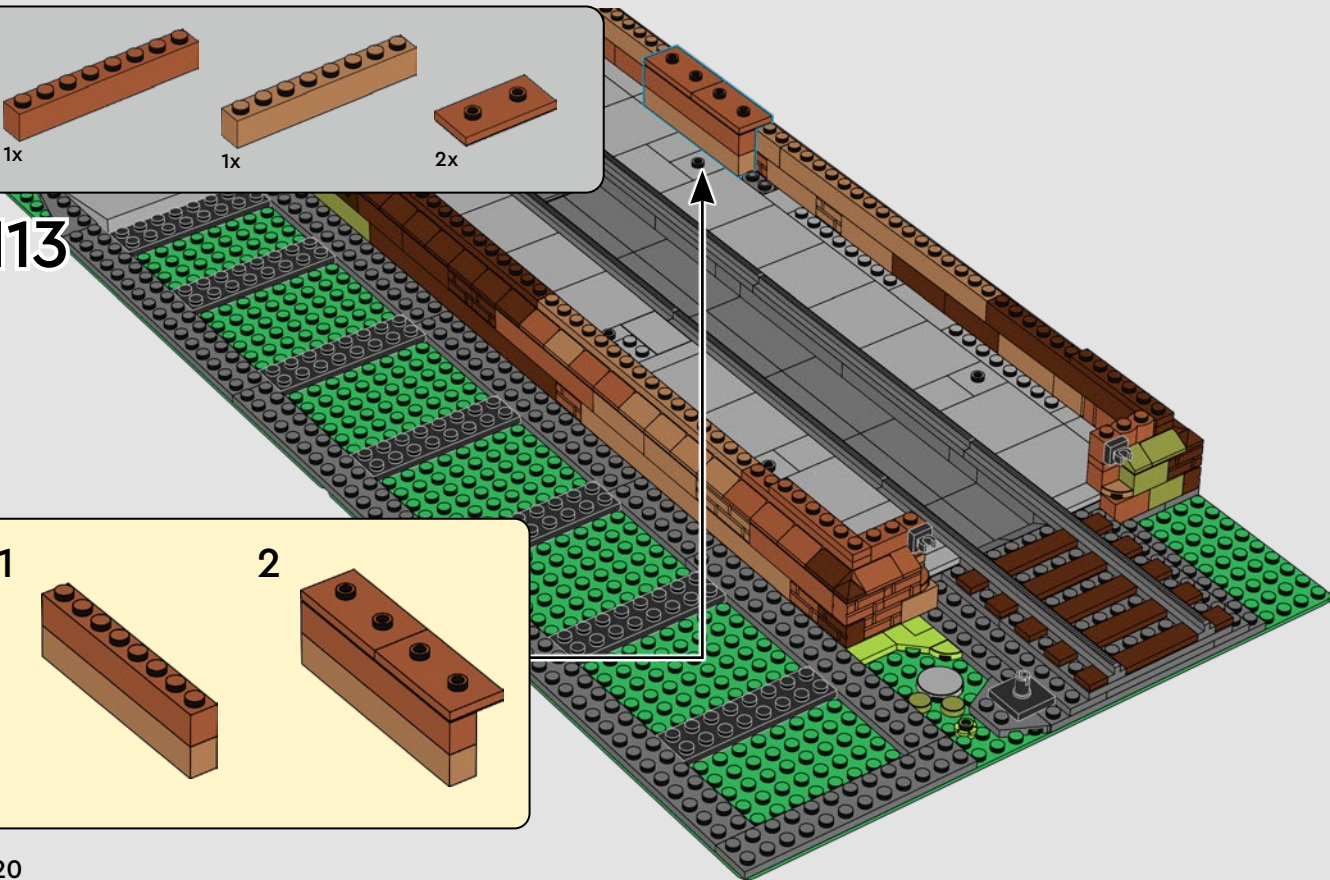

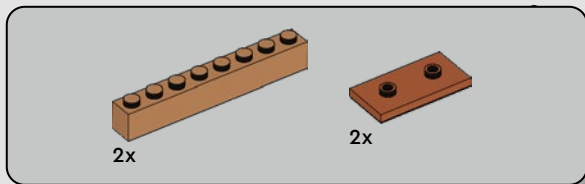

114

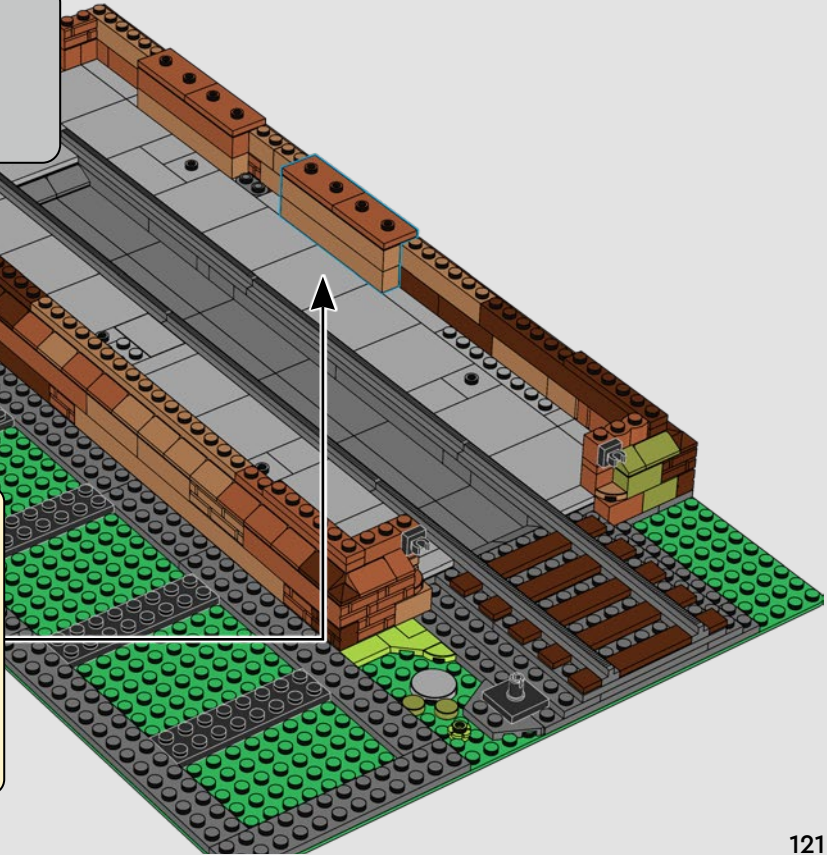
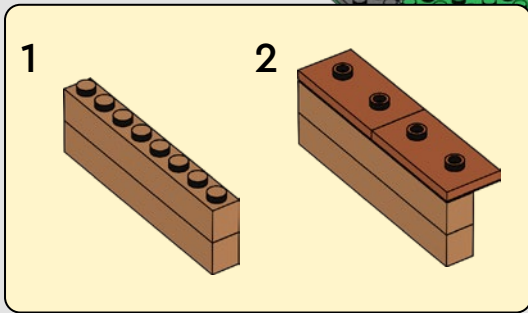

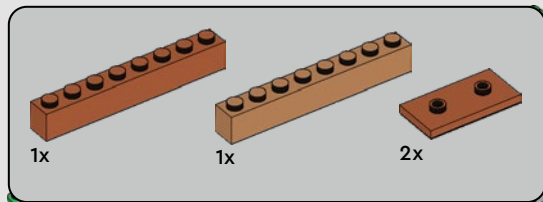

115

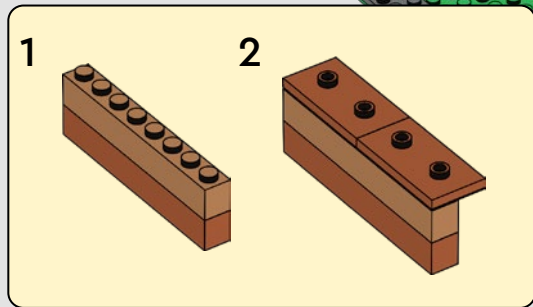

122

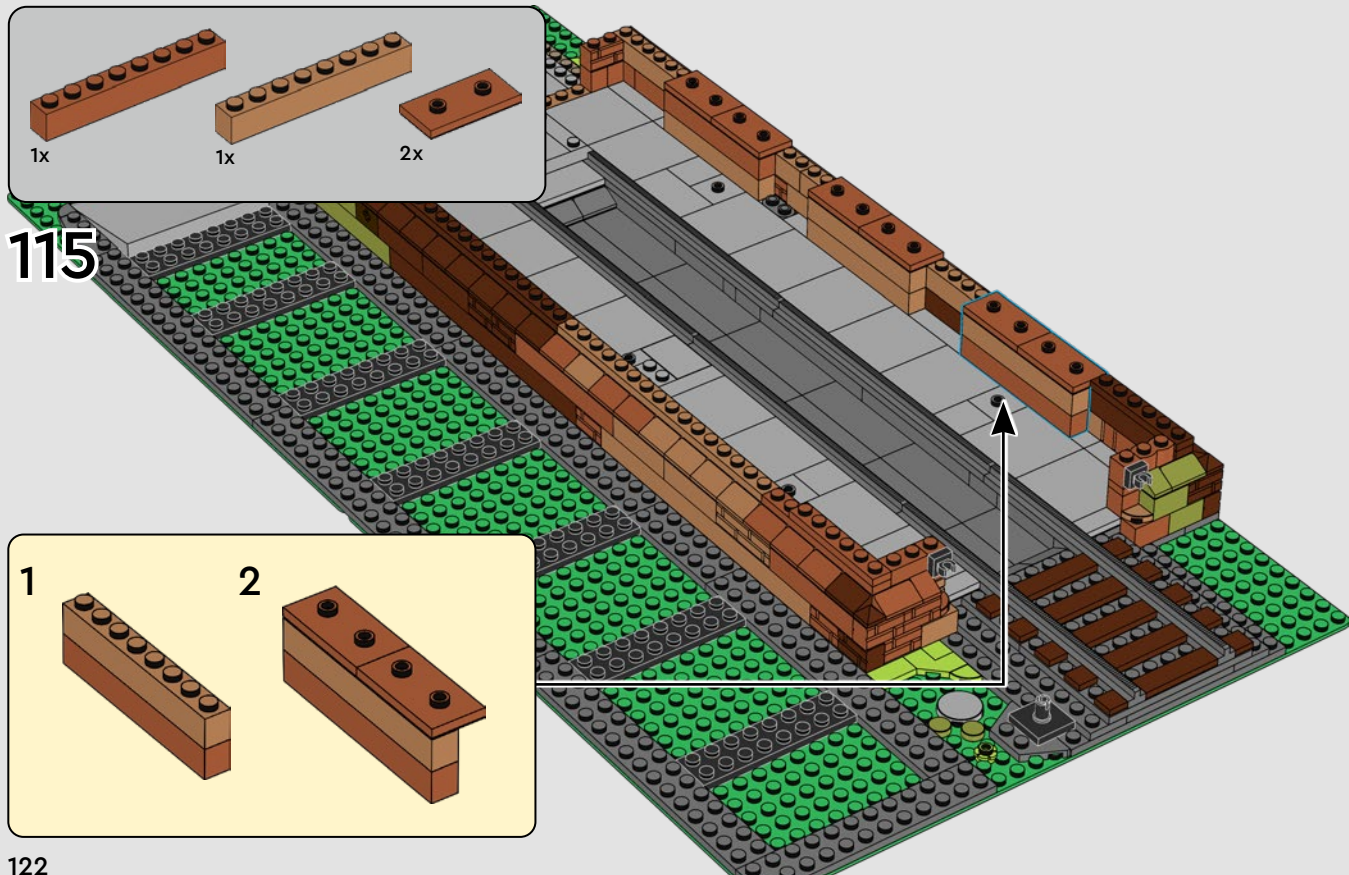

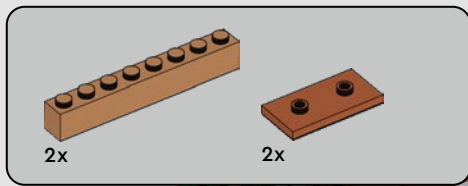

116

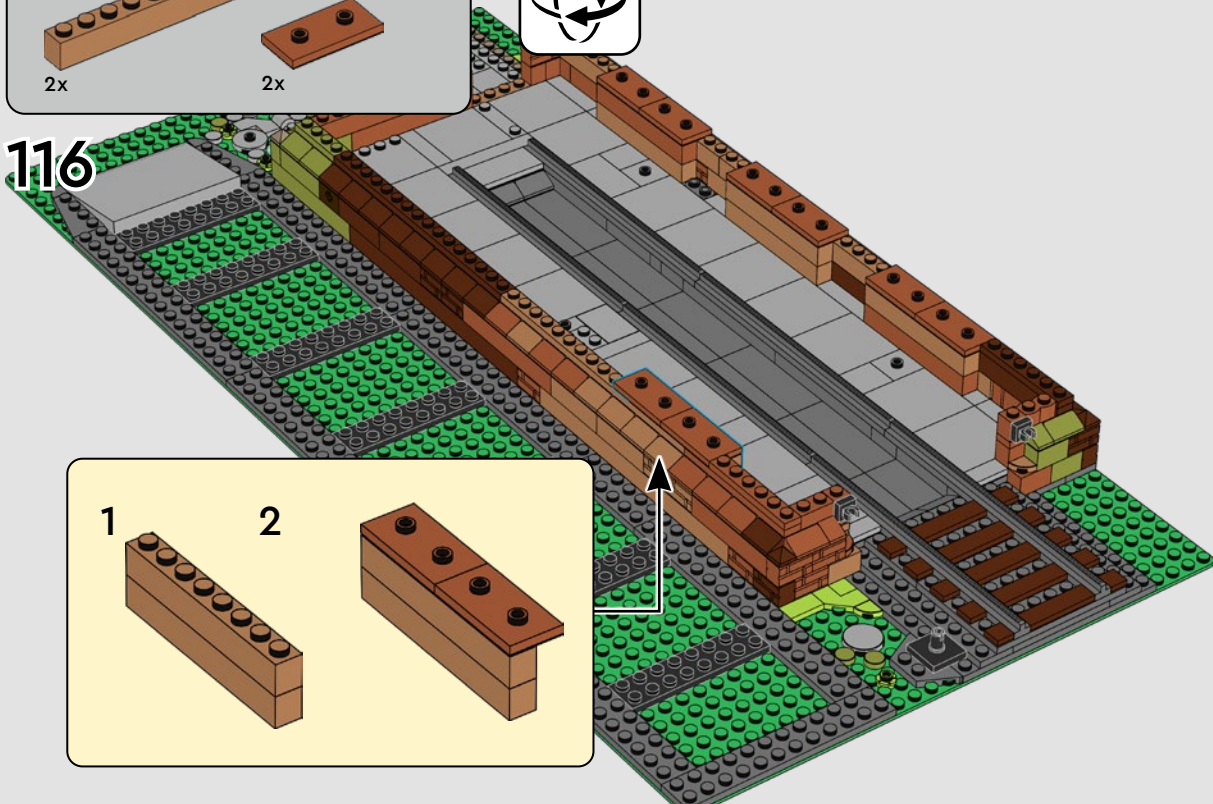
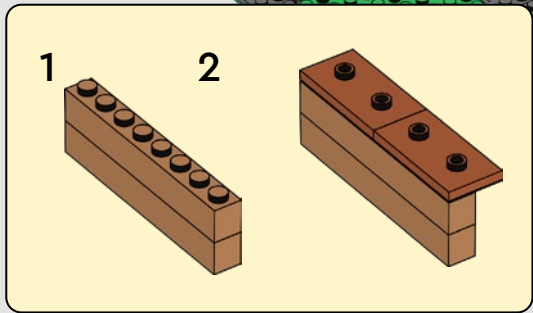

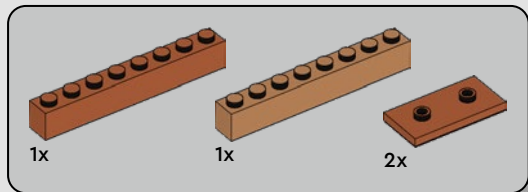

117

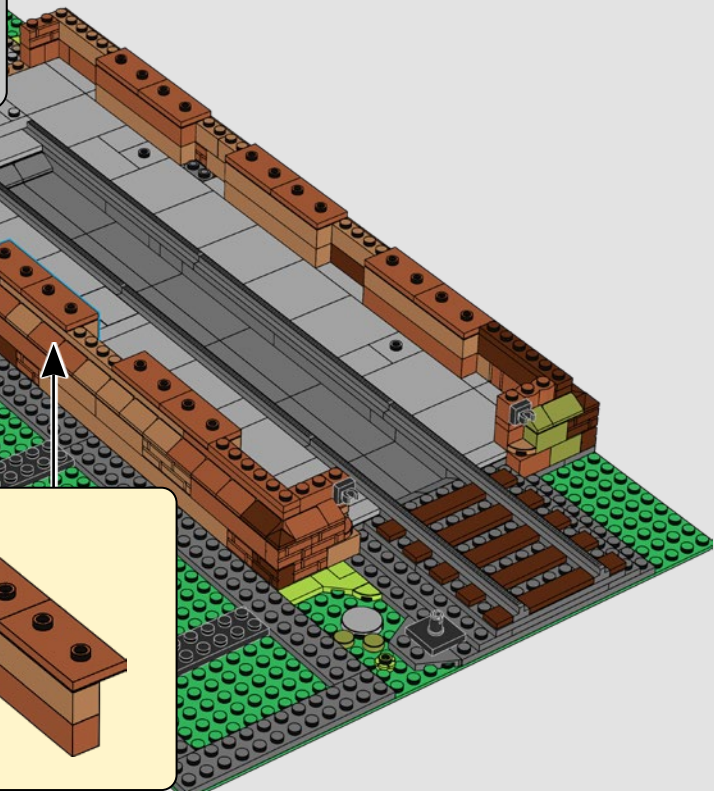
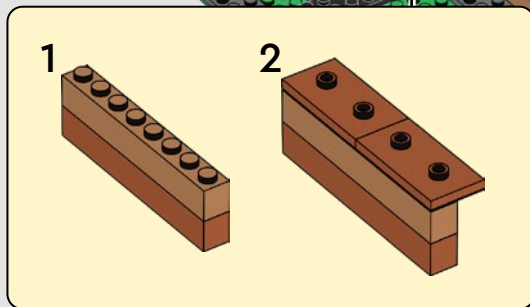

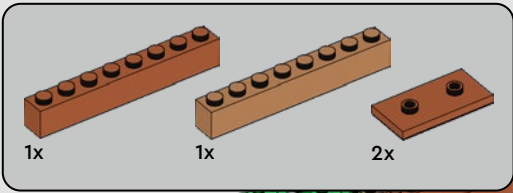

118

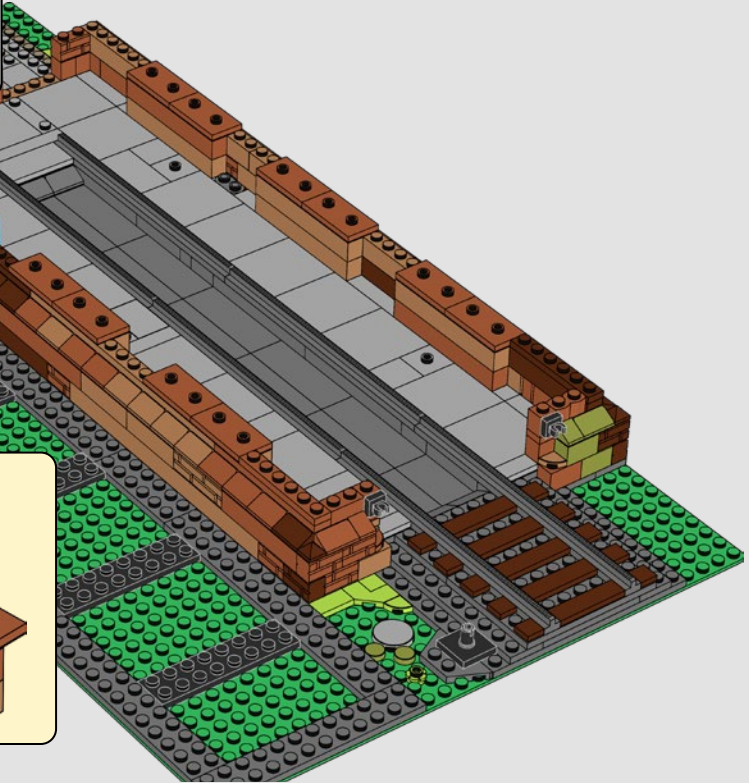
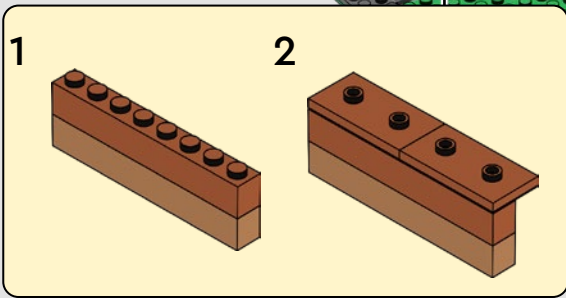

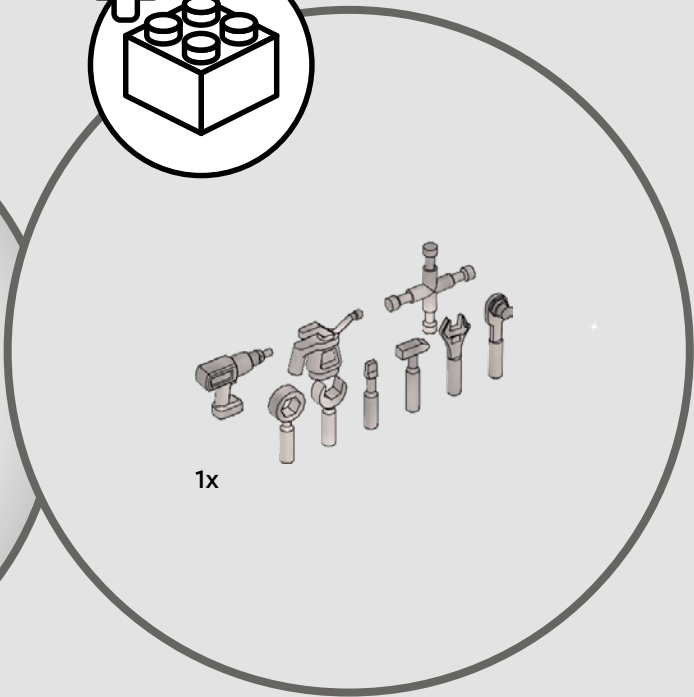
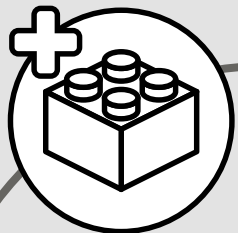

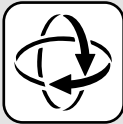
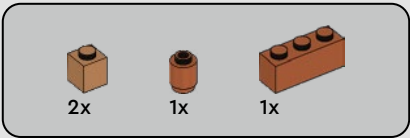

119

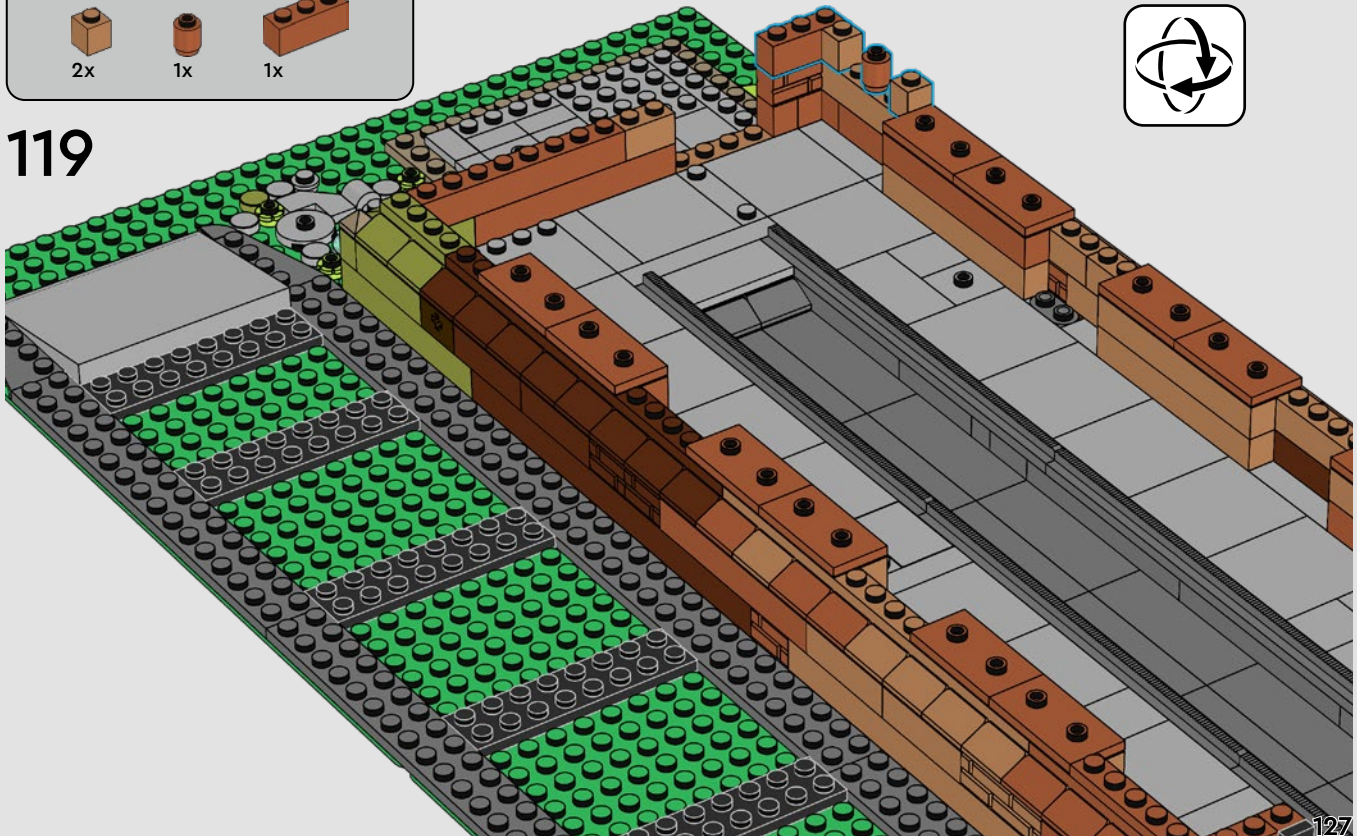



120

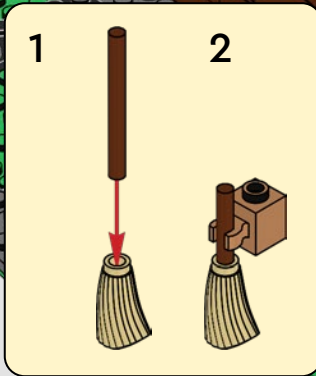
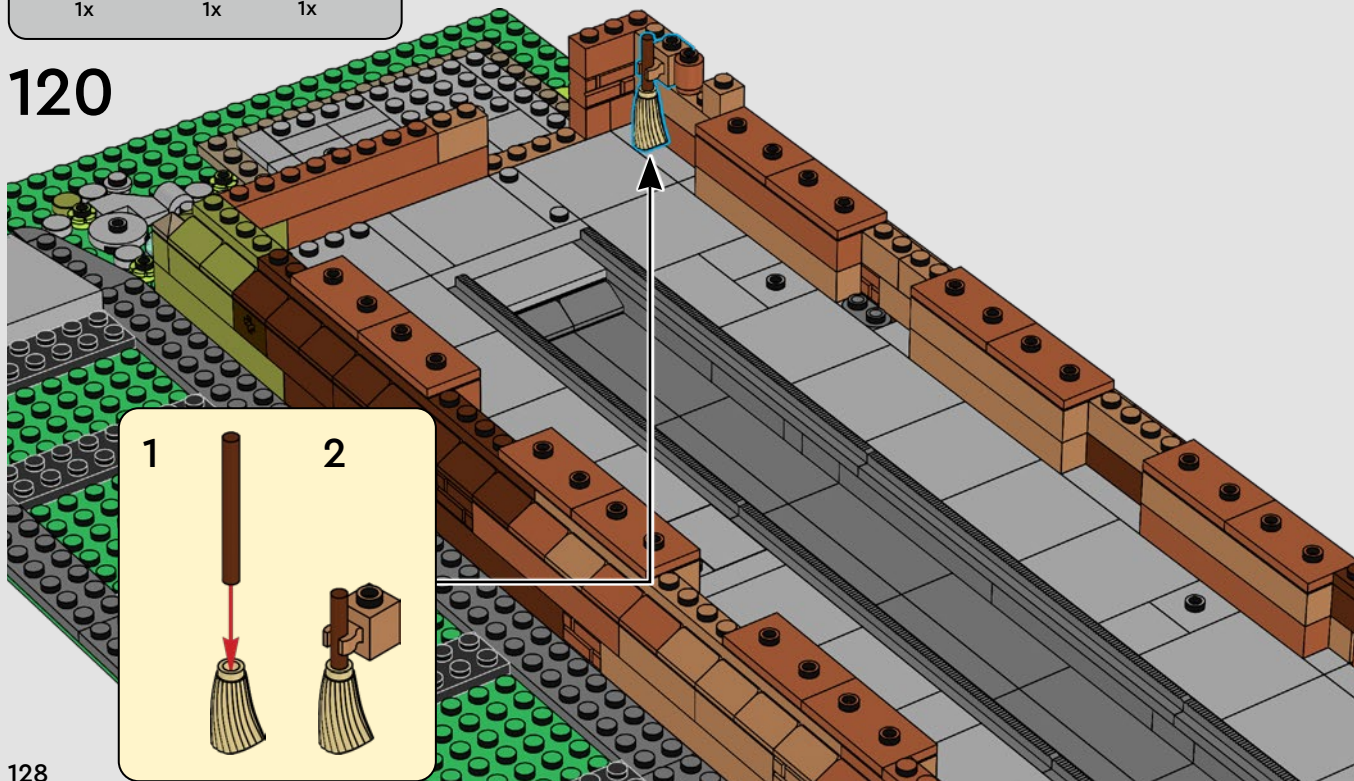

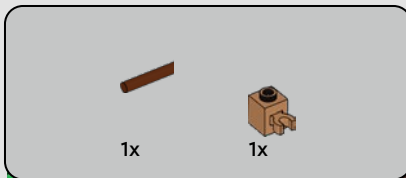

121

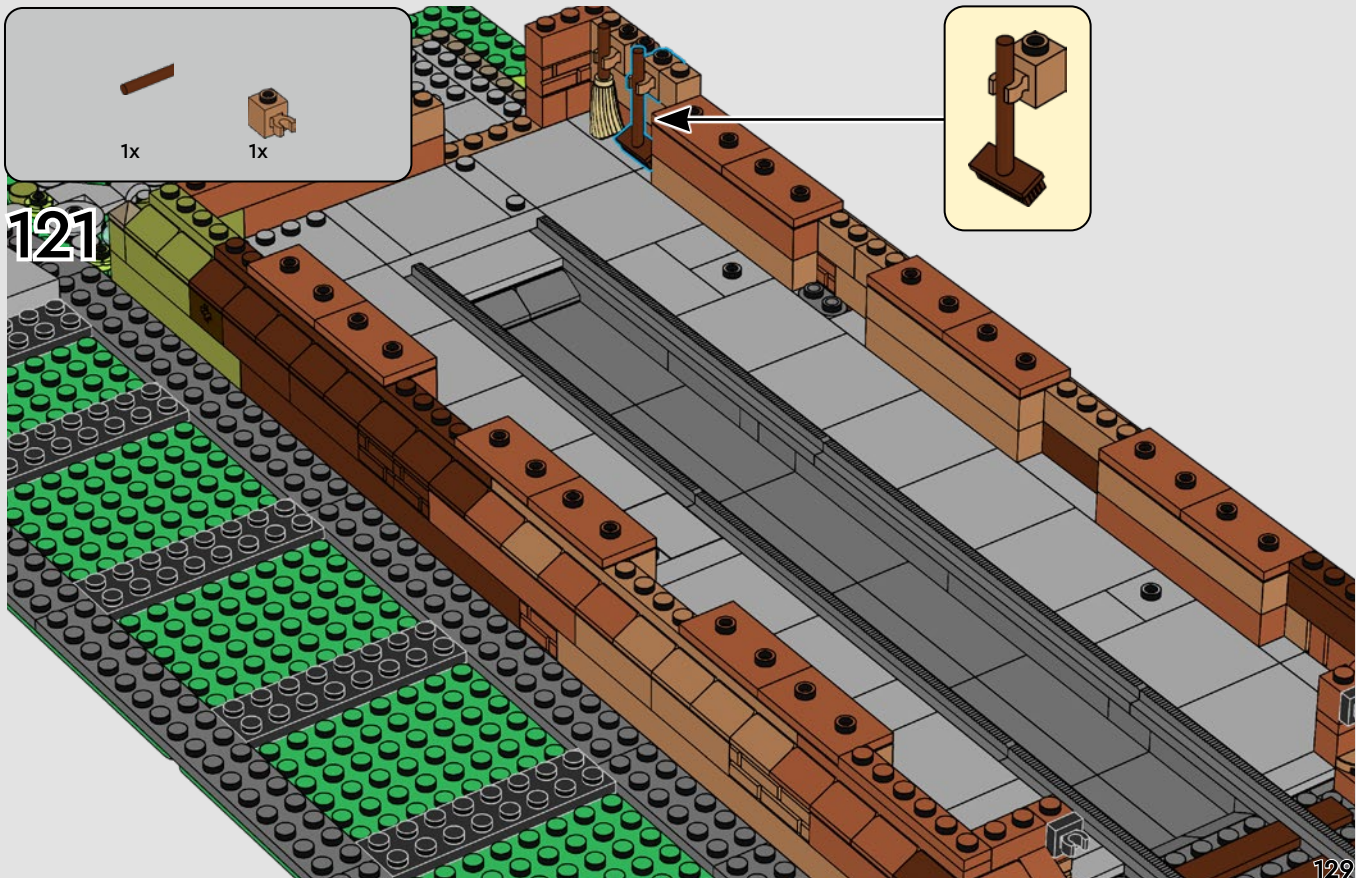

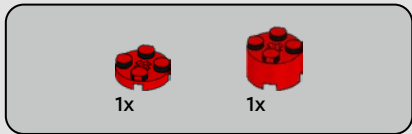

122

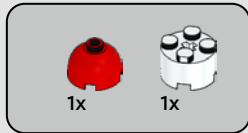
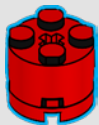

123



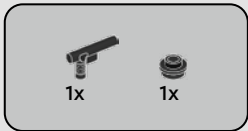

124

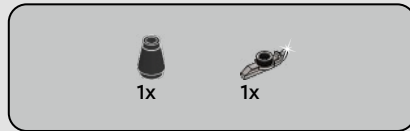
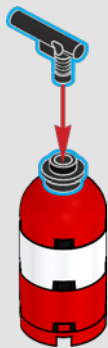

125



126

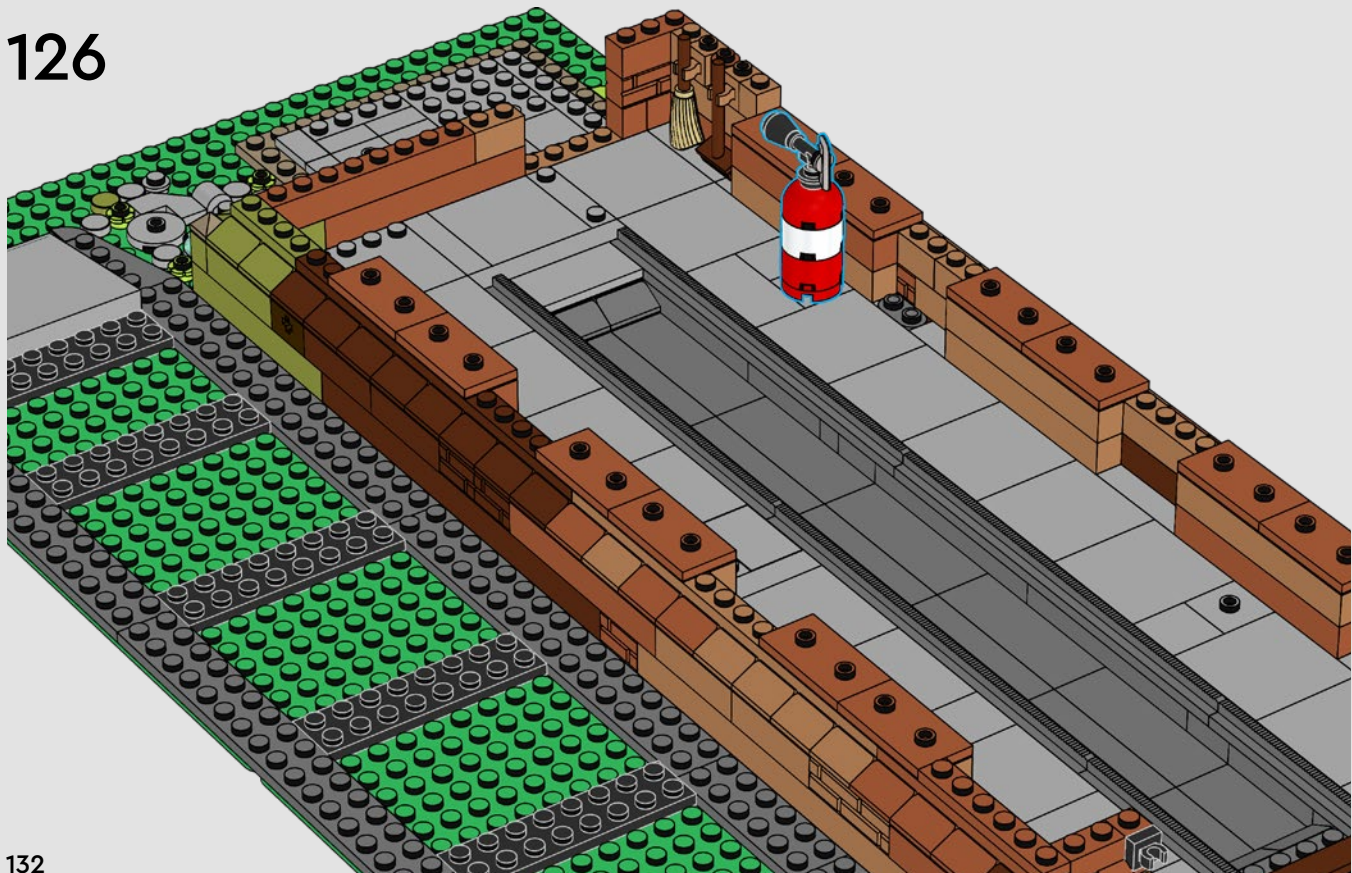

132

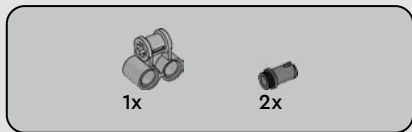
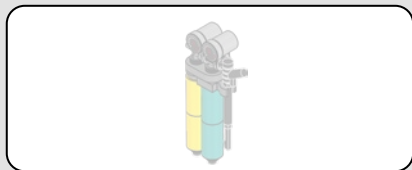

1x

2x

127

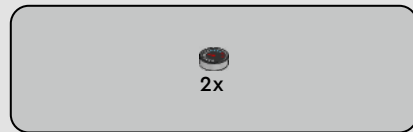
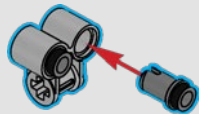

2x

128

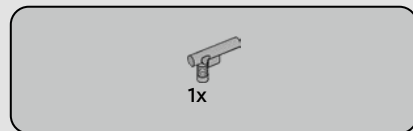
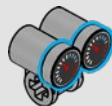

1x

129

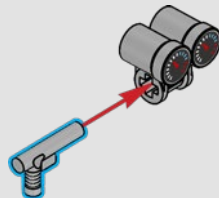



1x

130



1x



1x

131

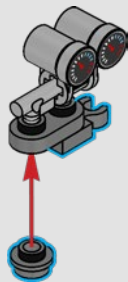

134



2x

132

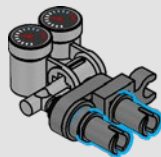

1x



1x

133

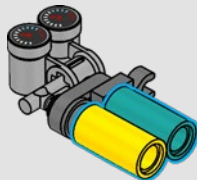



2x

134

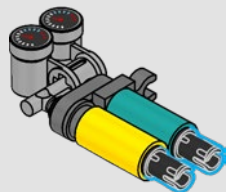

1x



1x

135

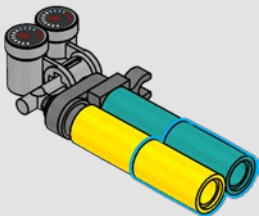

2x

136

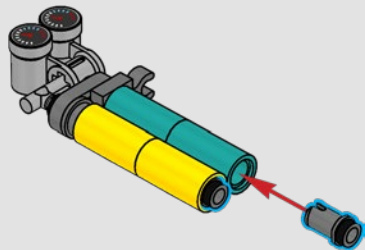

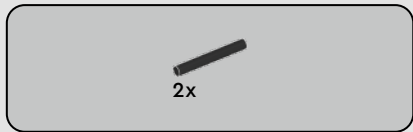

137

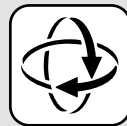
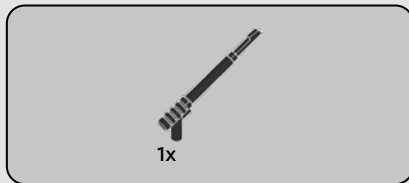
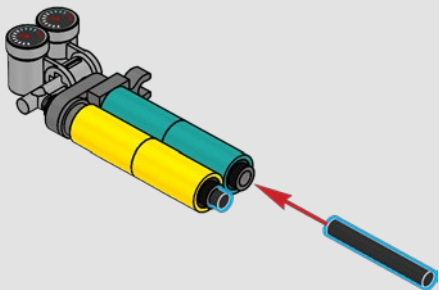

138

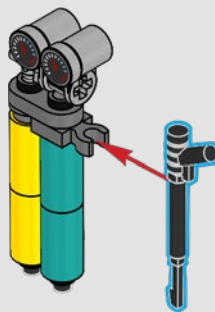

139

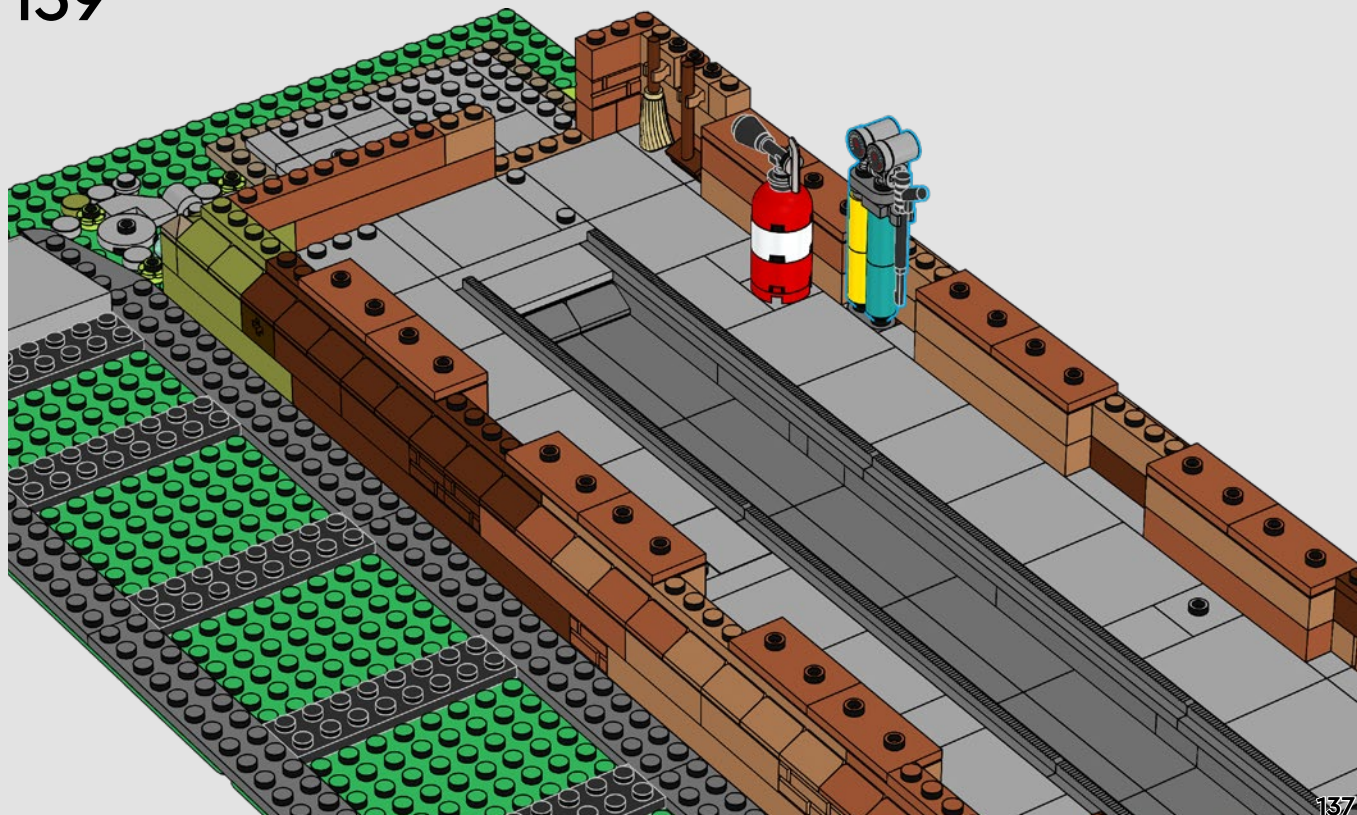

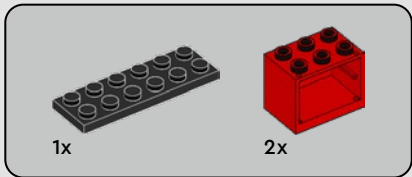
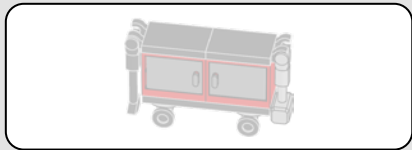

140

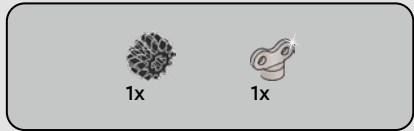
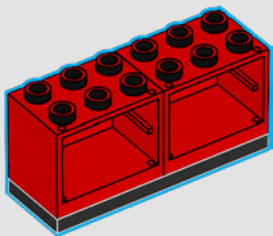

141

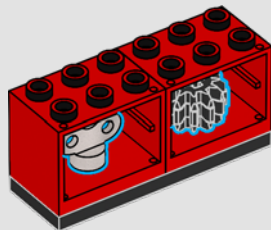

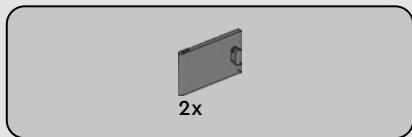

142

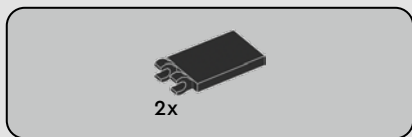
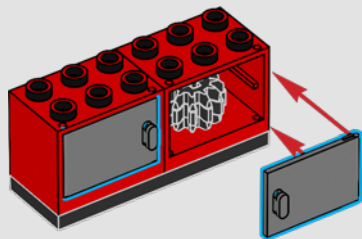

143

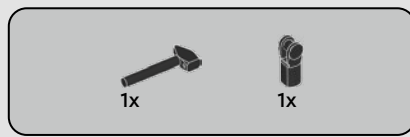
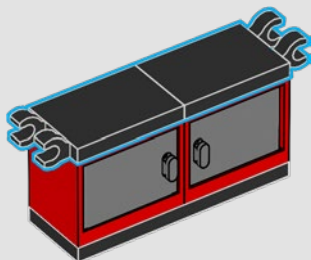

144

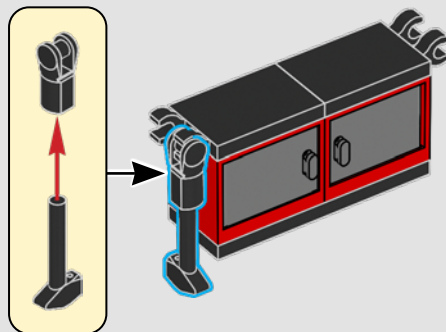

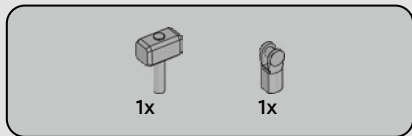

145

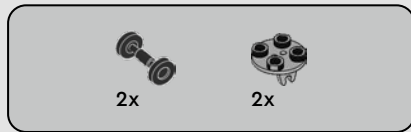
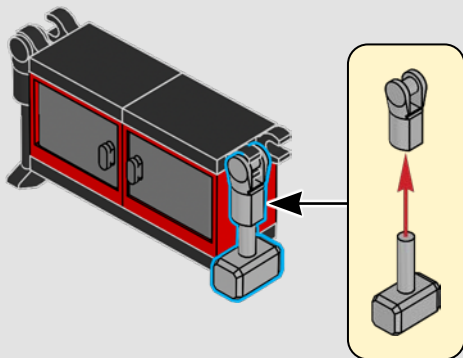

146

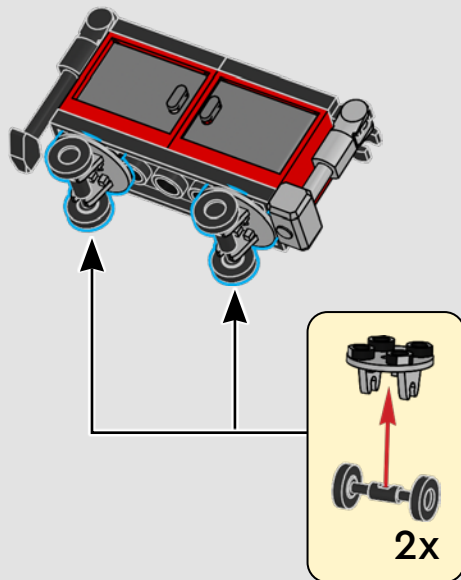

147

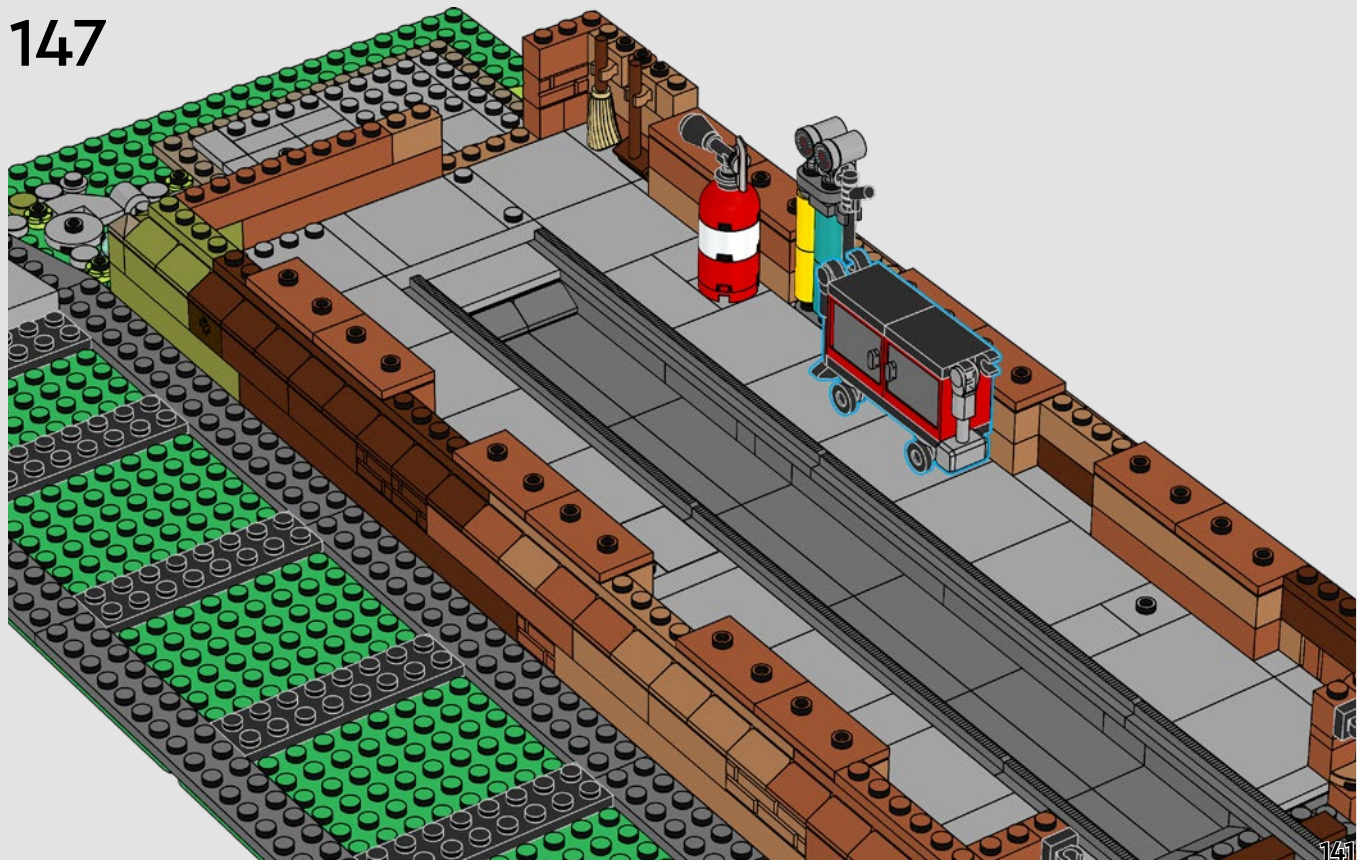

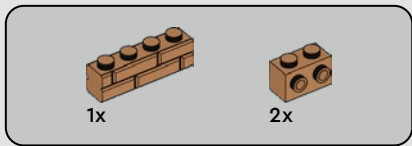
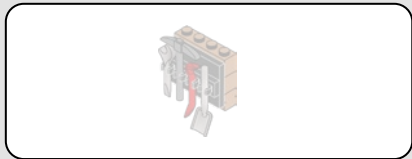

148

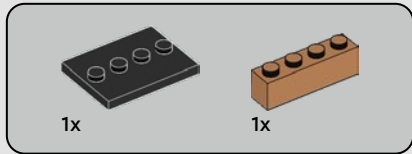
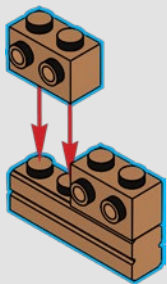

149

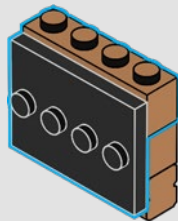



4x

150

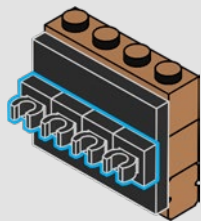

1x



1x



1x



1x



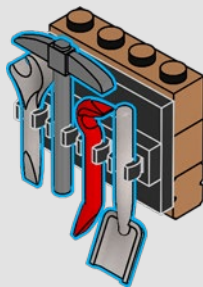

151

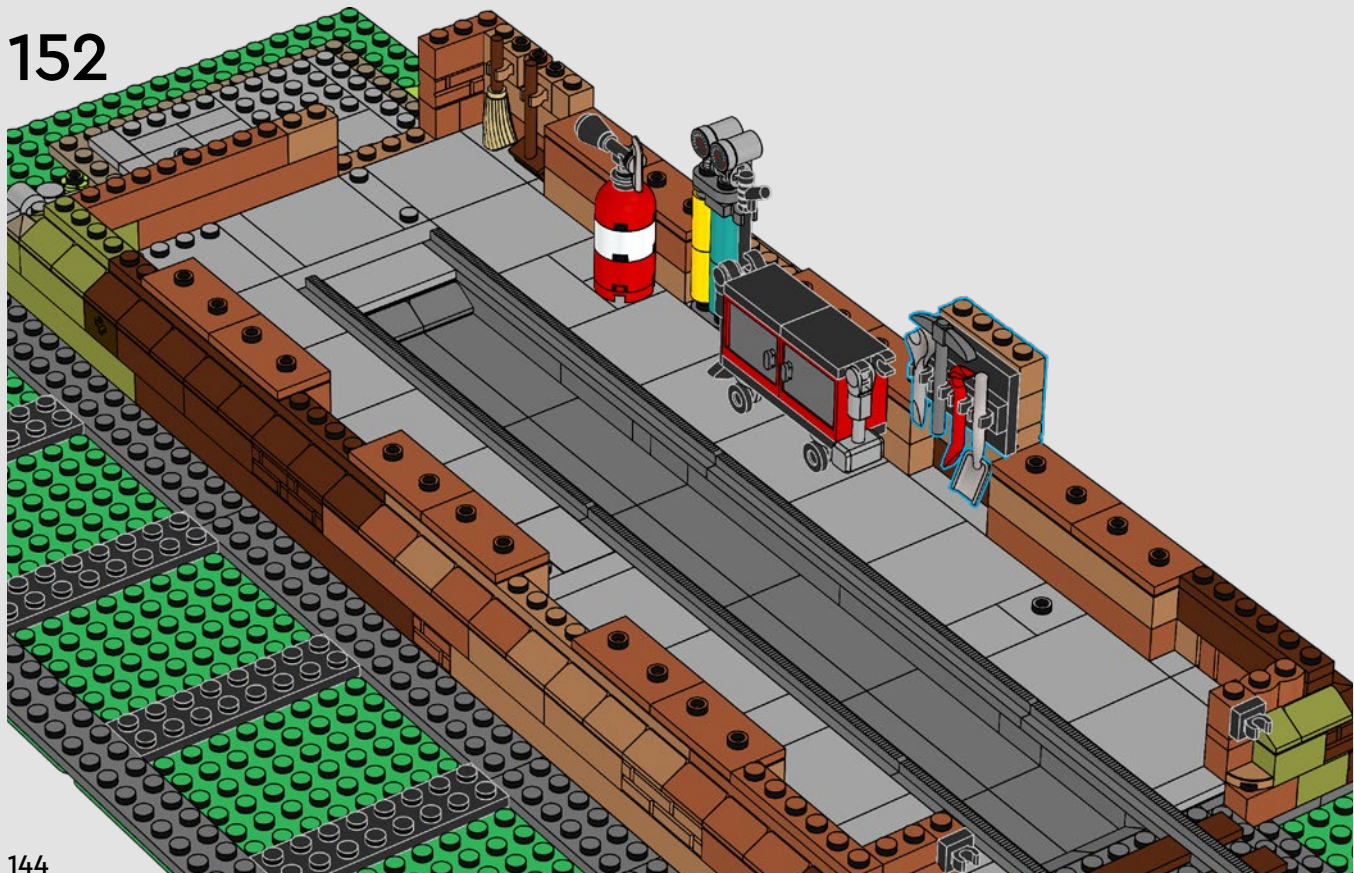

152





144

- 
1x
- 
1x
- 
1x
- 
1x

153

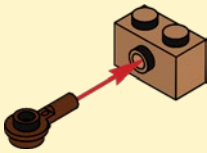

- 1

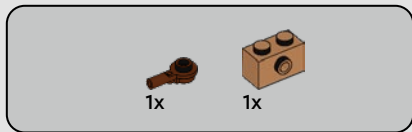
- 2

- 3

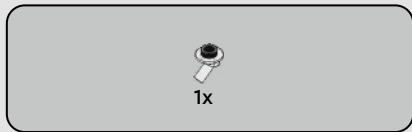
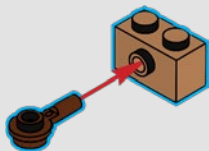

154

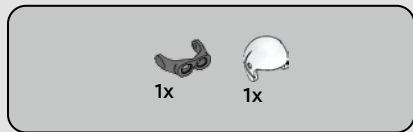
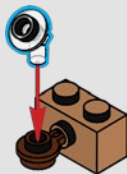

155



156

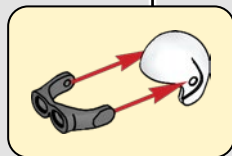

157

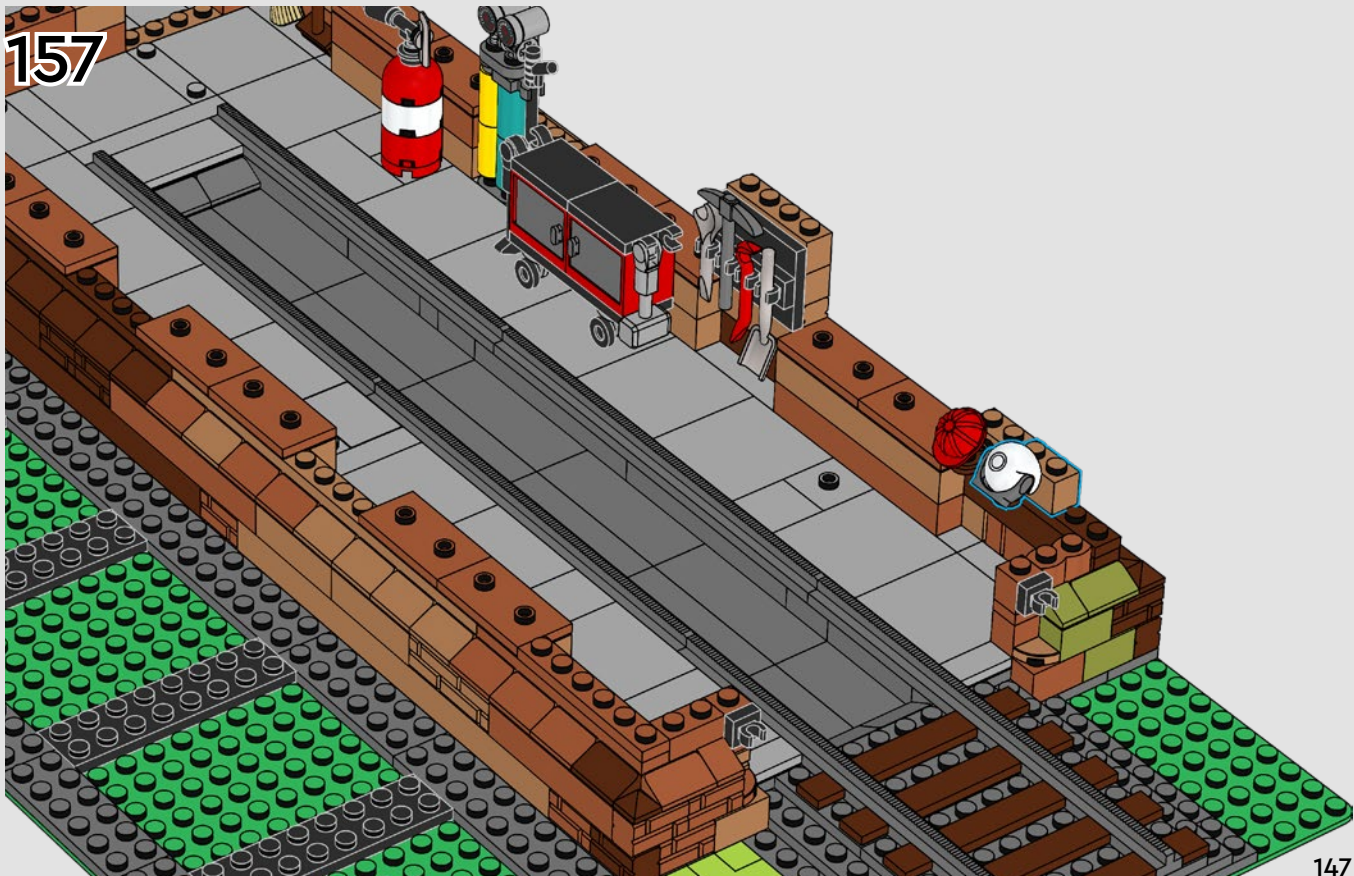

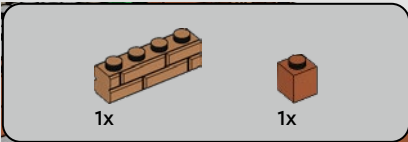

158

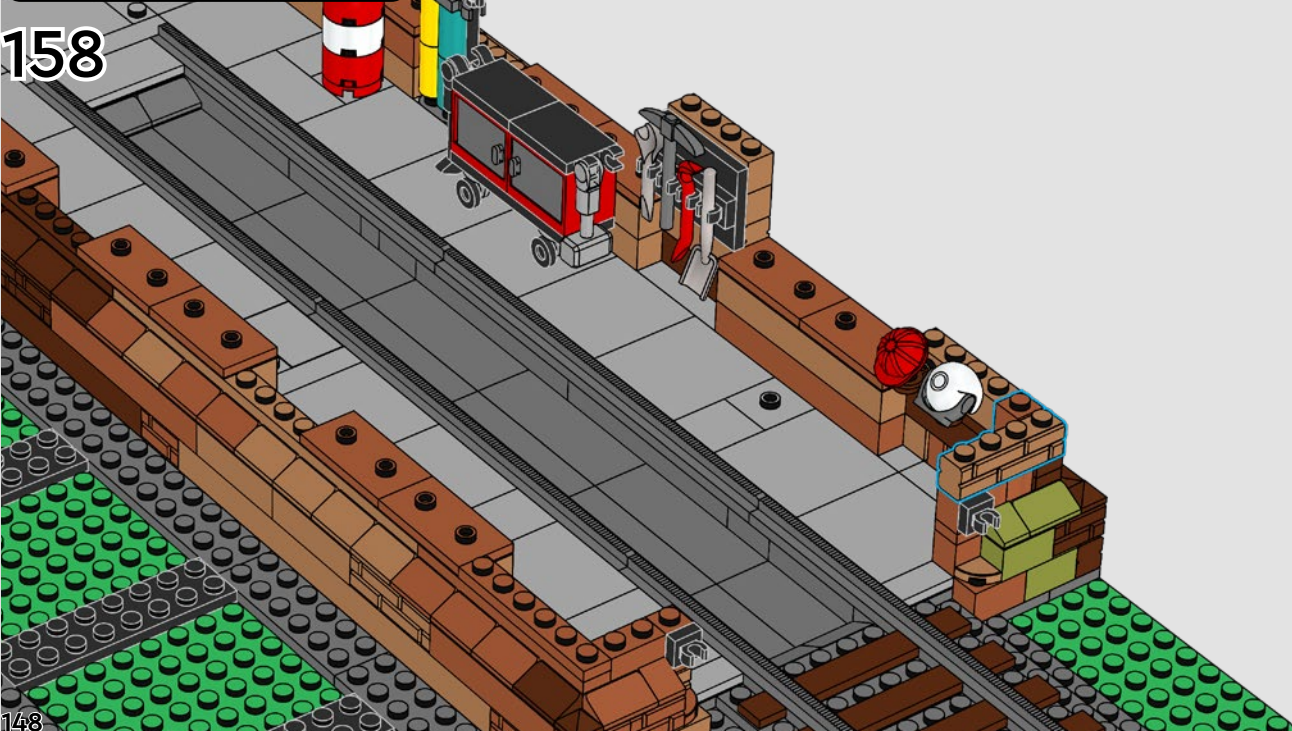

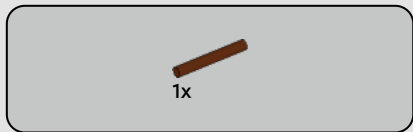

163

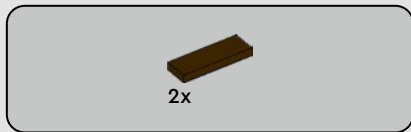
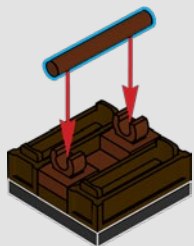

164

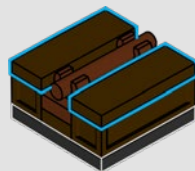

165

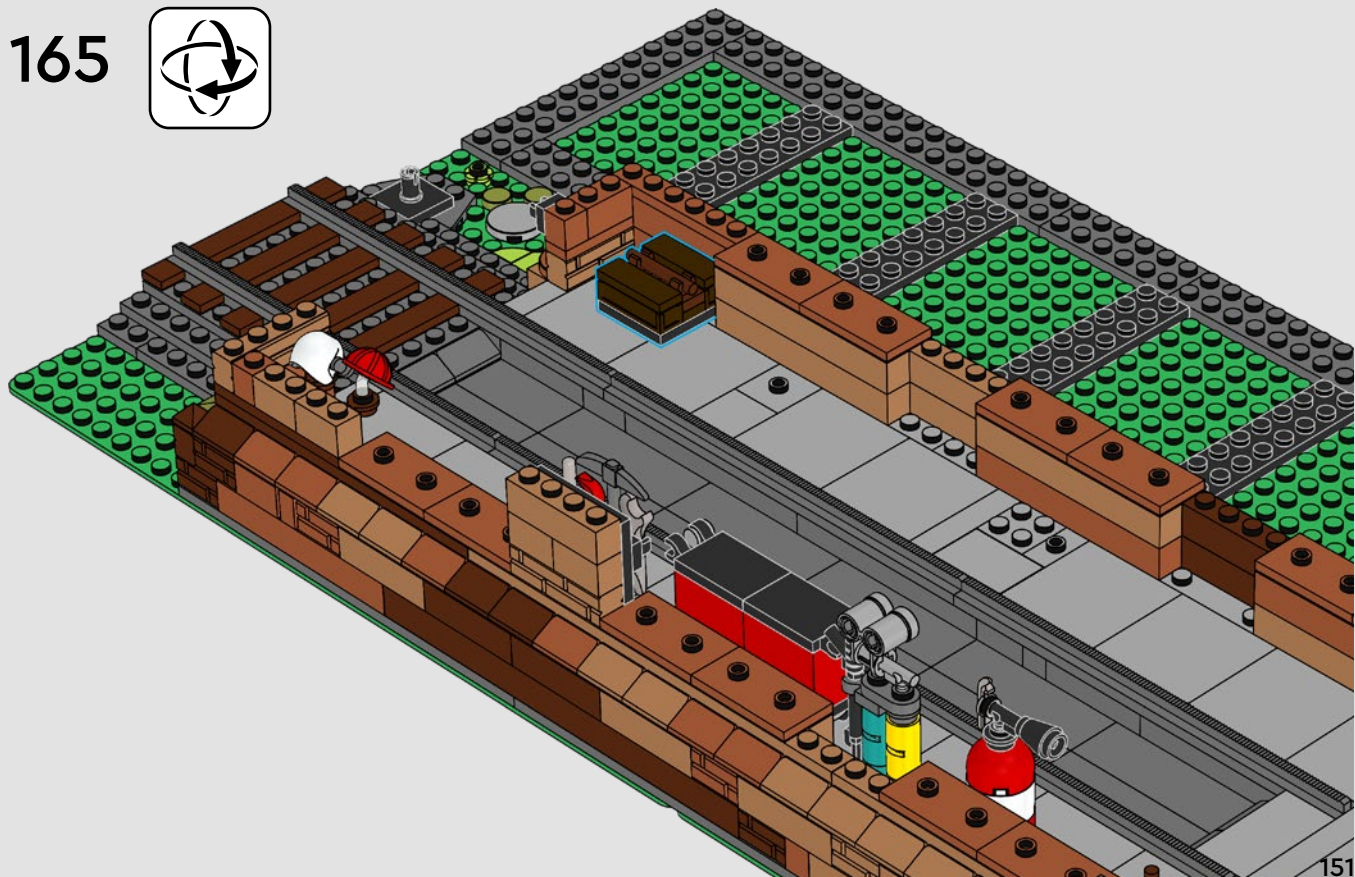

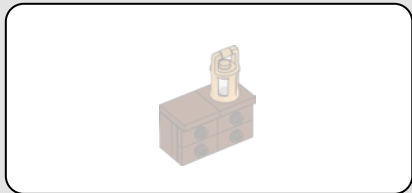

166

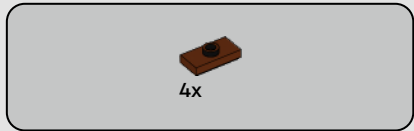
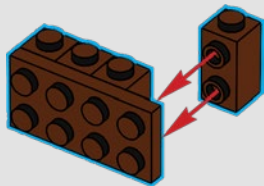

167

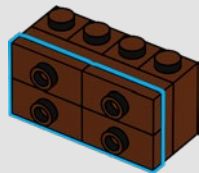

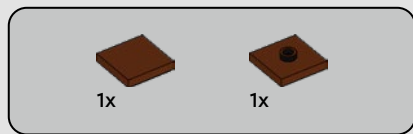

168

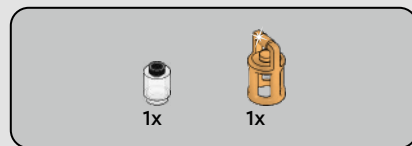
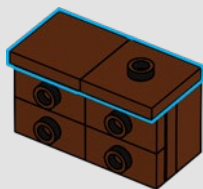

169

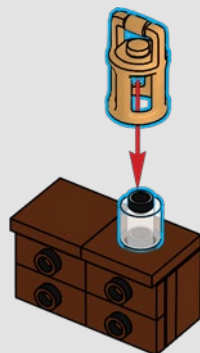

170

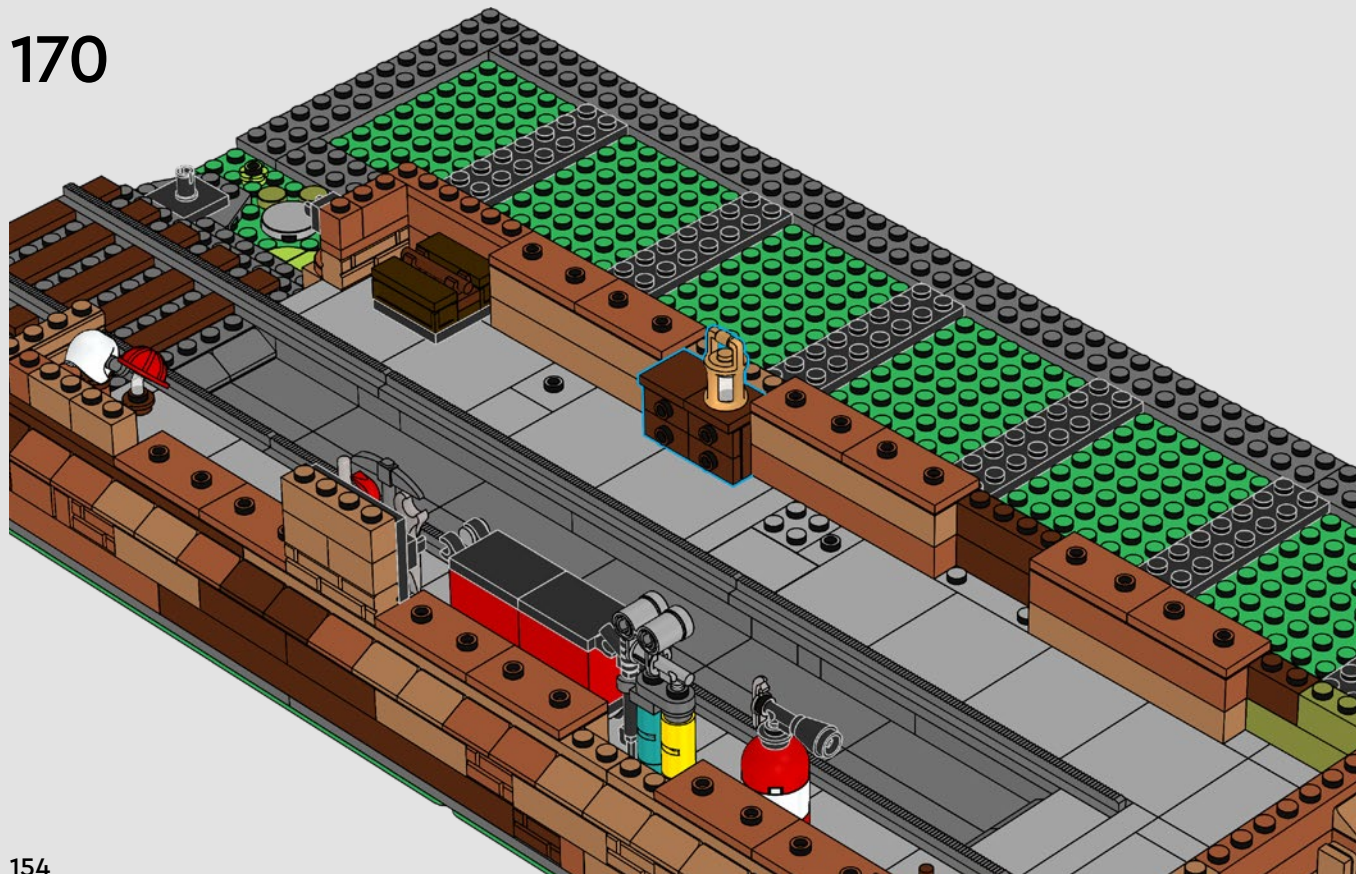



1x



2x

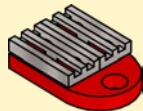

171

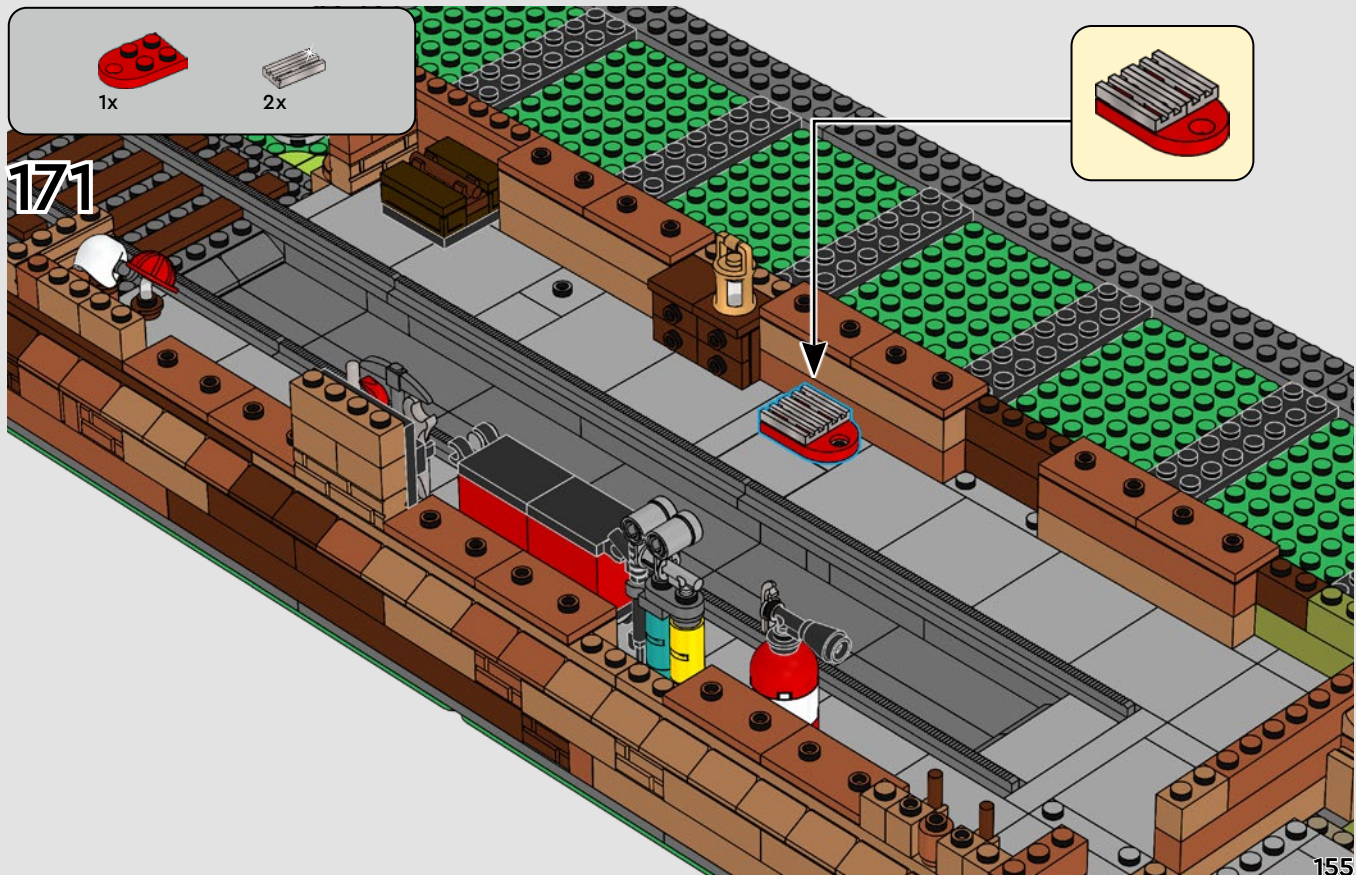

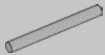

1x

172

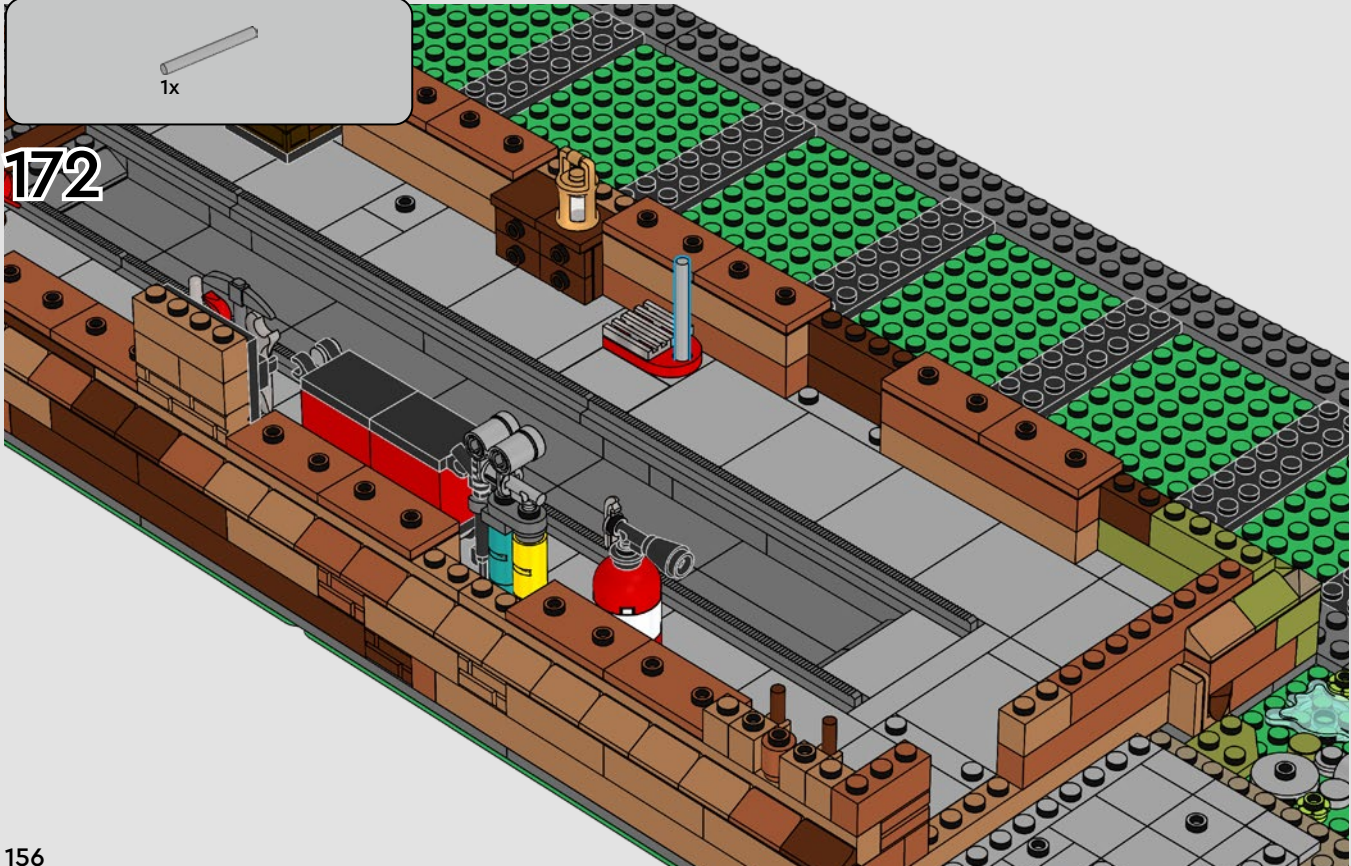

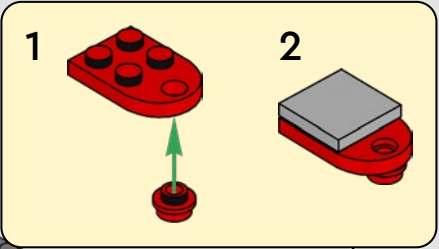
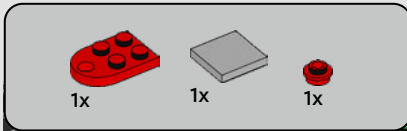

173

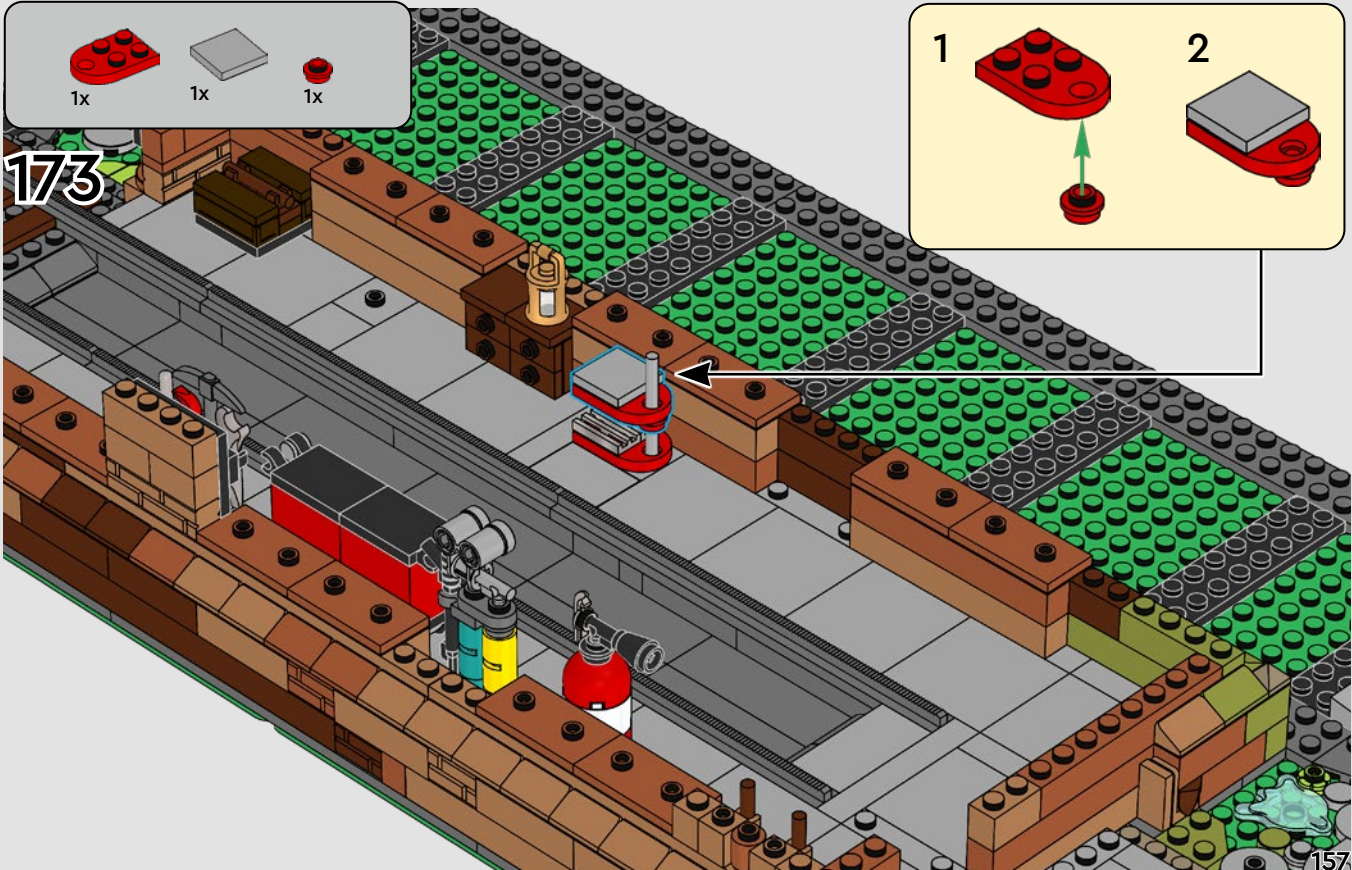



174

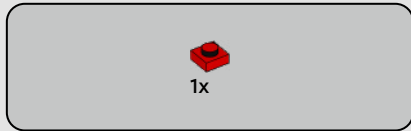

175



176





177

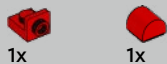

178

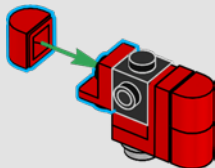

179

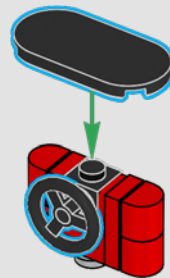

180

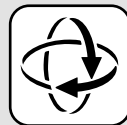
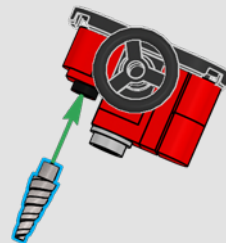

181

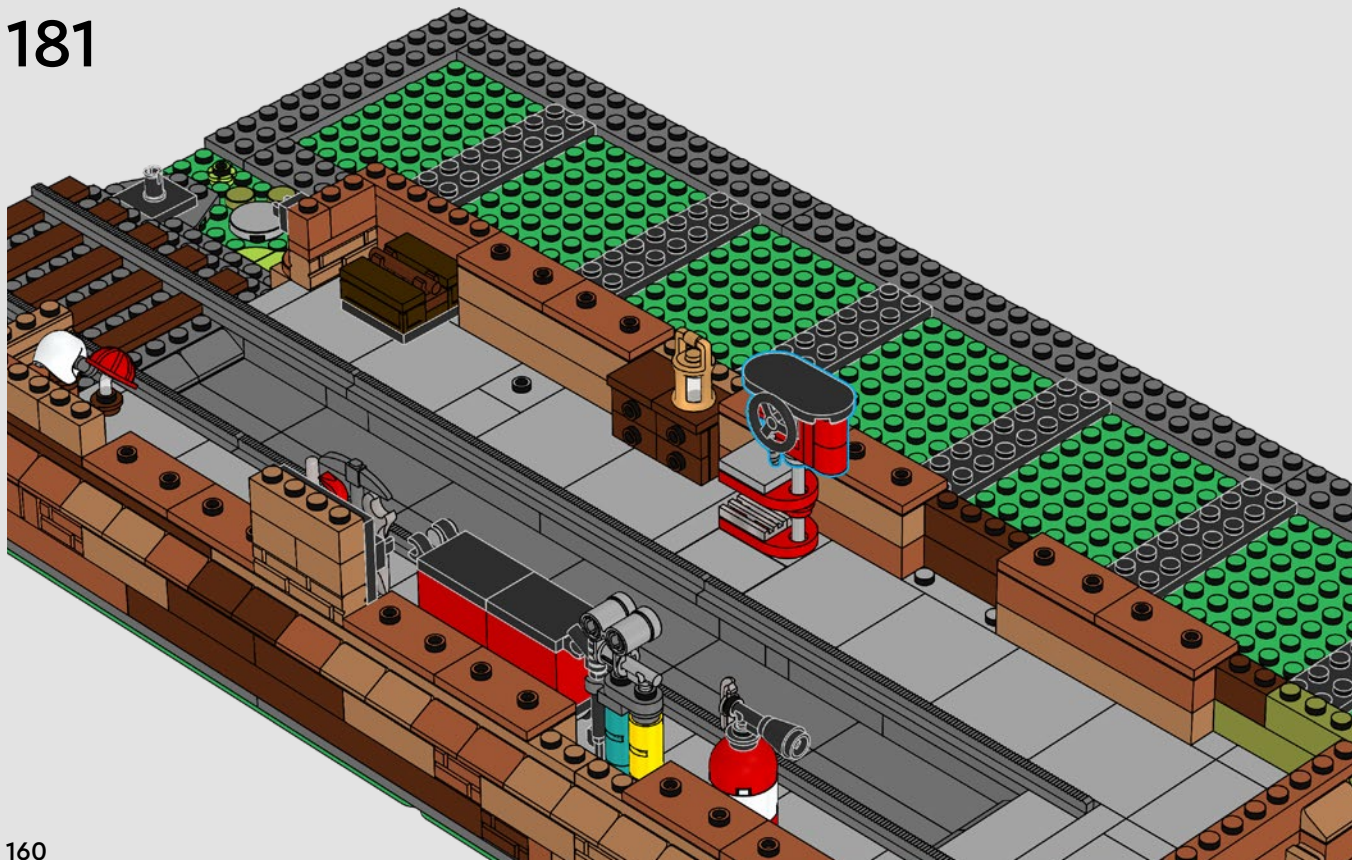

160

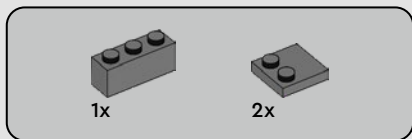
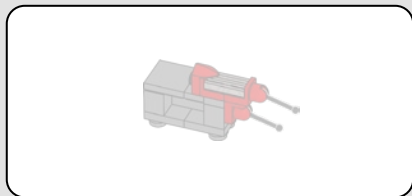

182

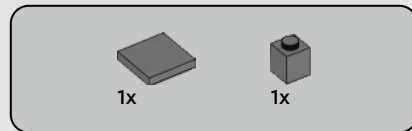
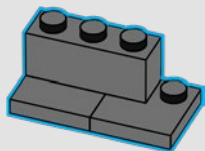

183

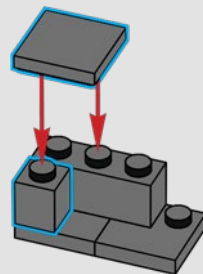

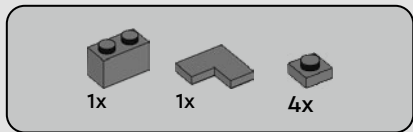

184

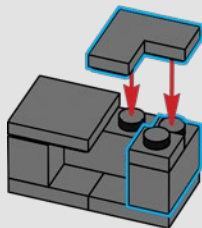

185

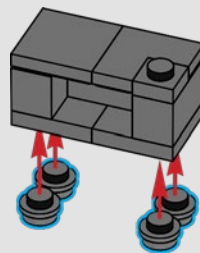

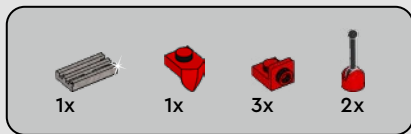

186

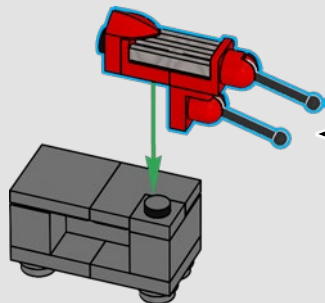
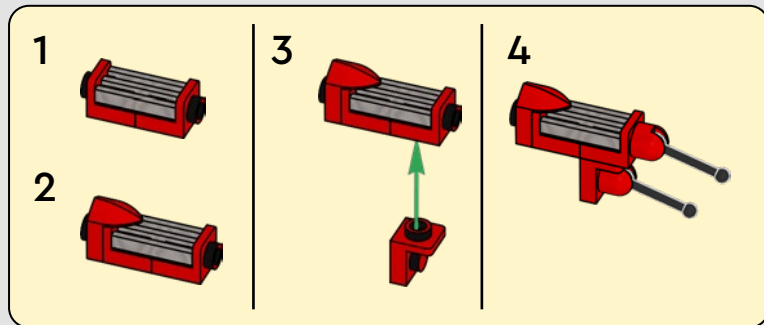

187

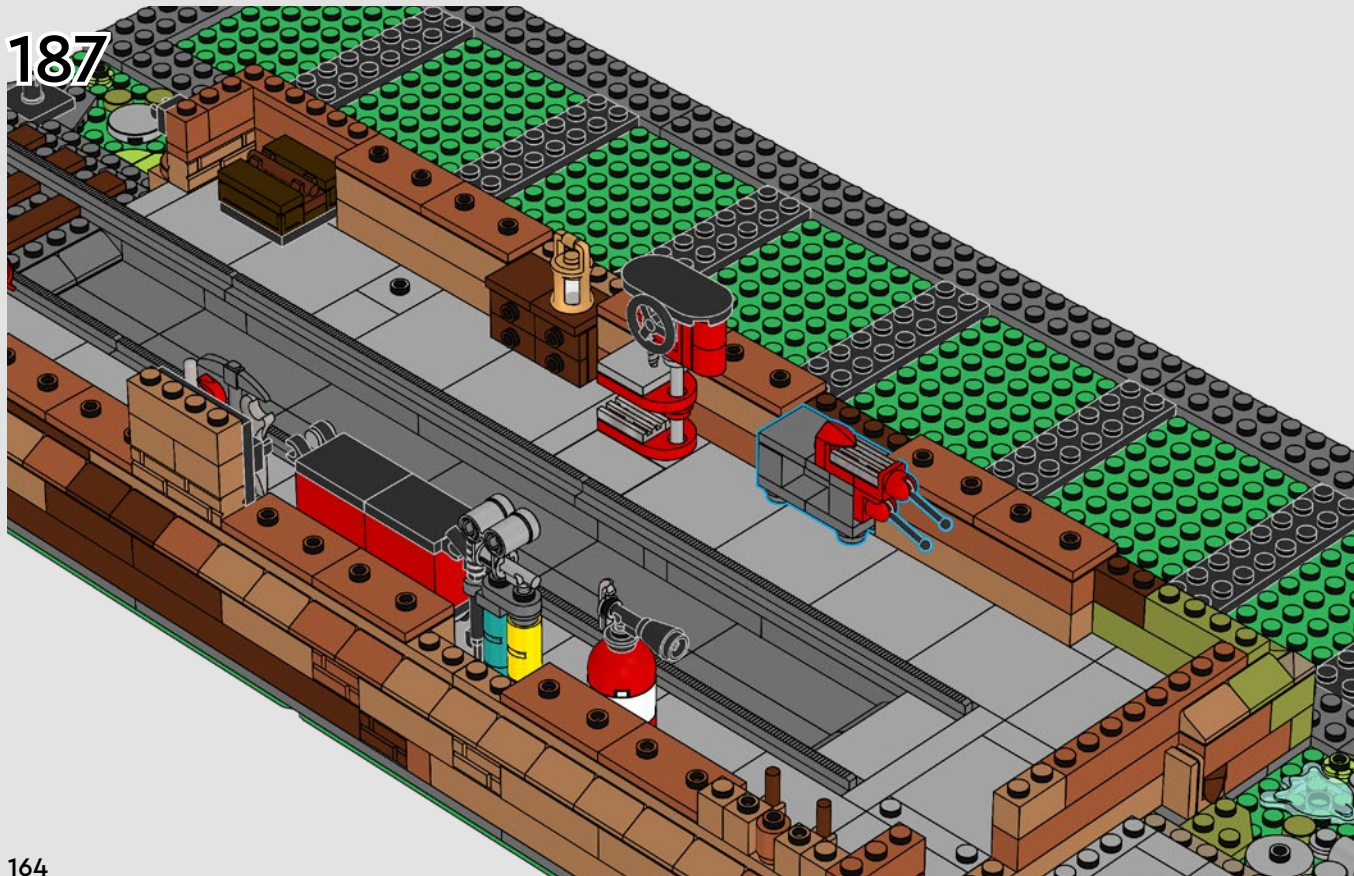

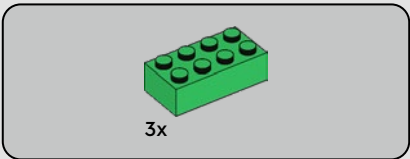
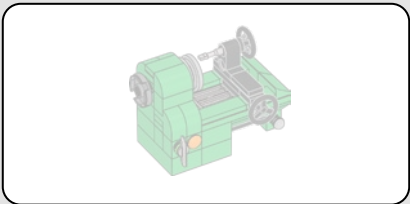

188

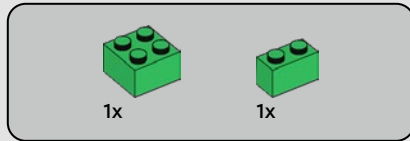
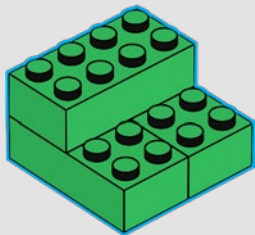

189

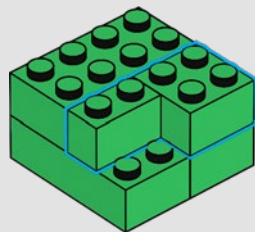

190

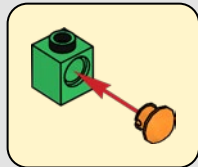
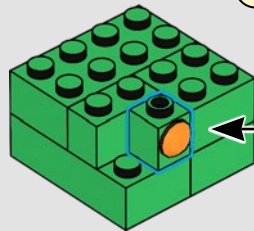



191

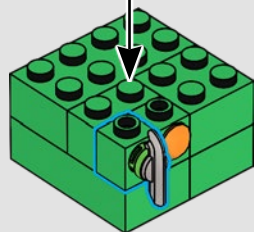
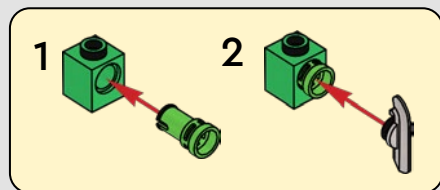

192

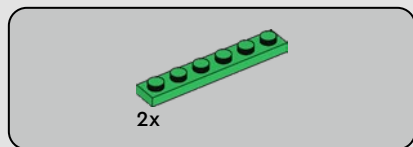
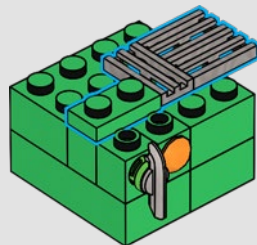

193

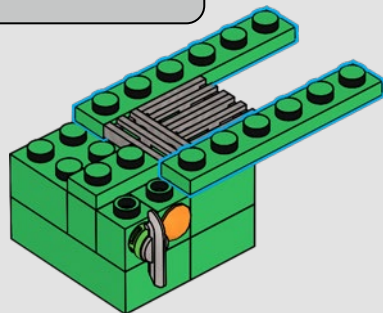

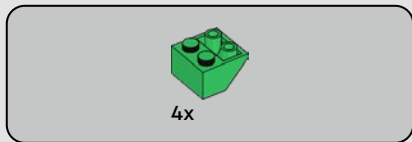

194

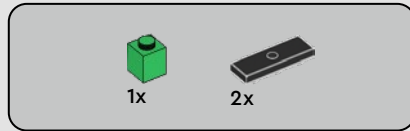
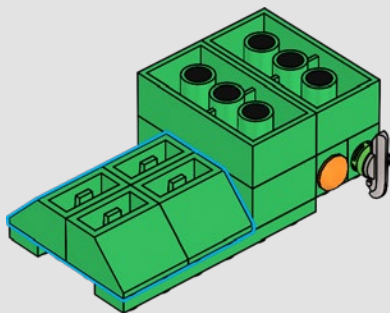

195

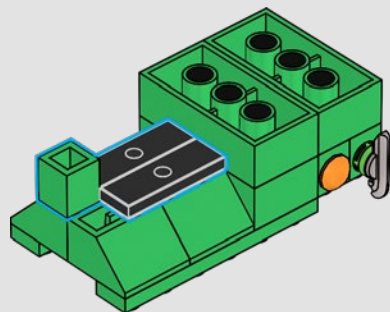



1x



1x

196

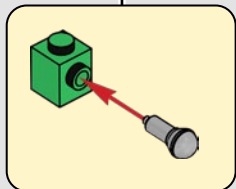
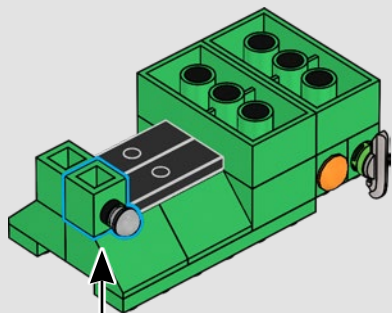

168



1x



2x

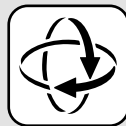

197

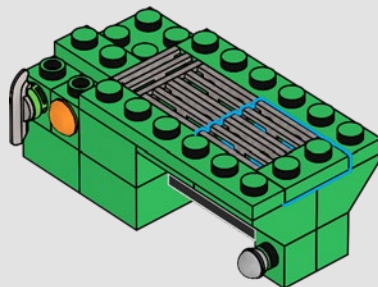

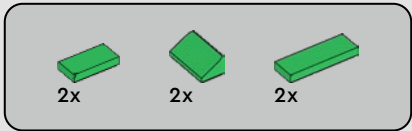

198

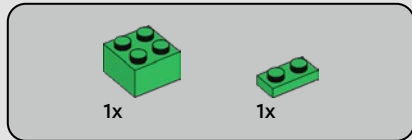
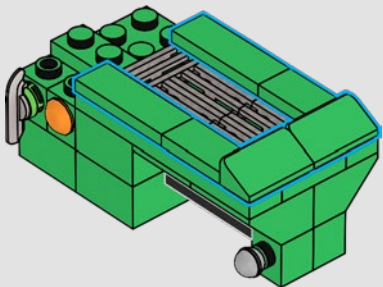

199

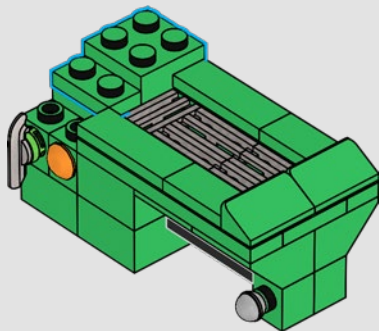



2x

200

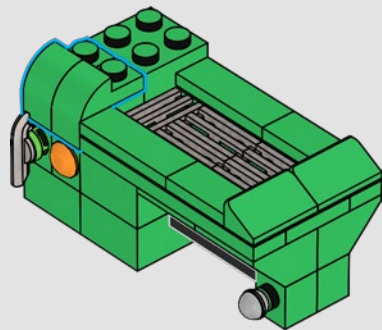

1x



1x



1x

201

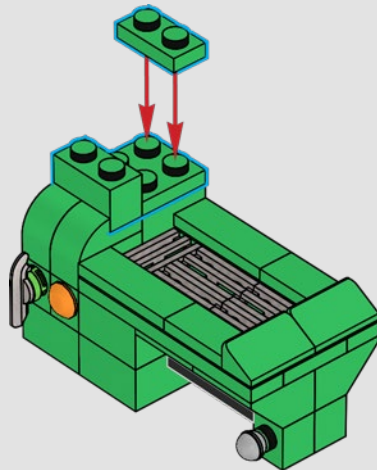

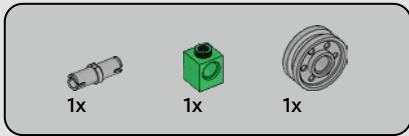

202

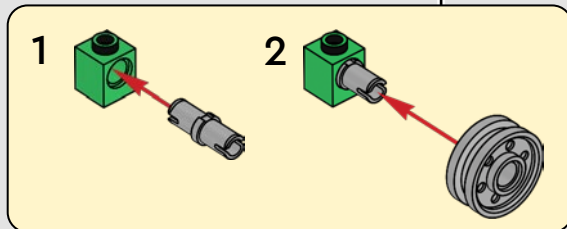
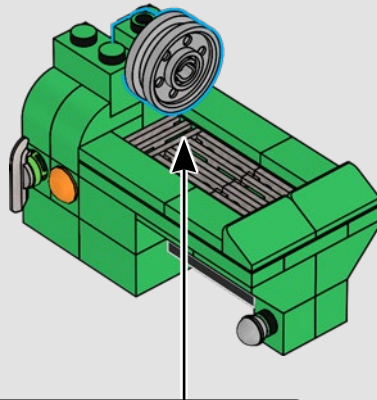

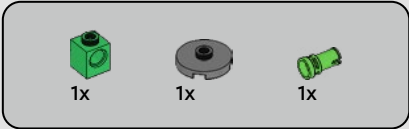

203

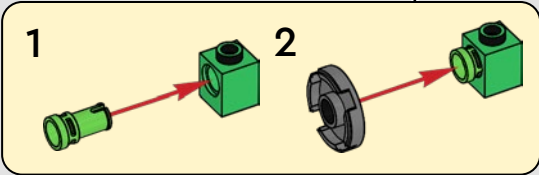
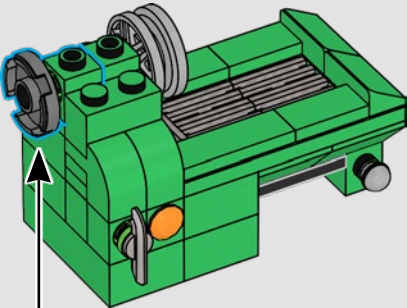



1x



1x

206

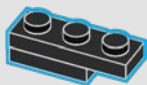

1x



1x

207

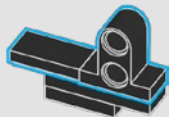

1x

208

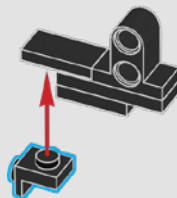

1x

209

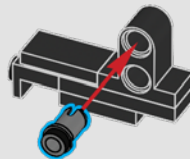

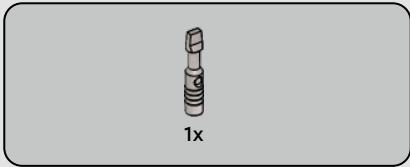

210

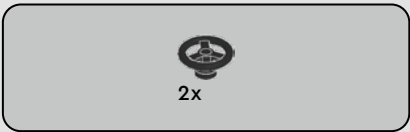
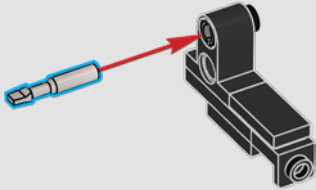

211

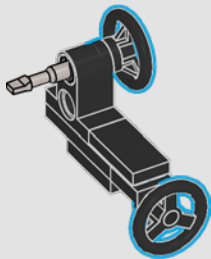

212

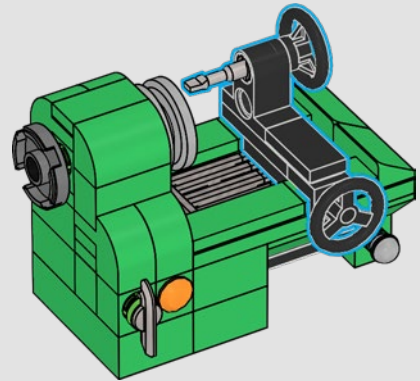

213

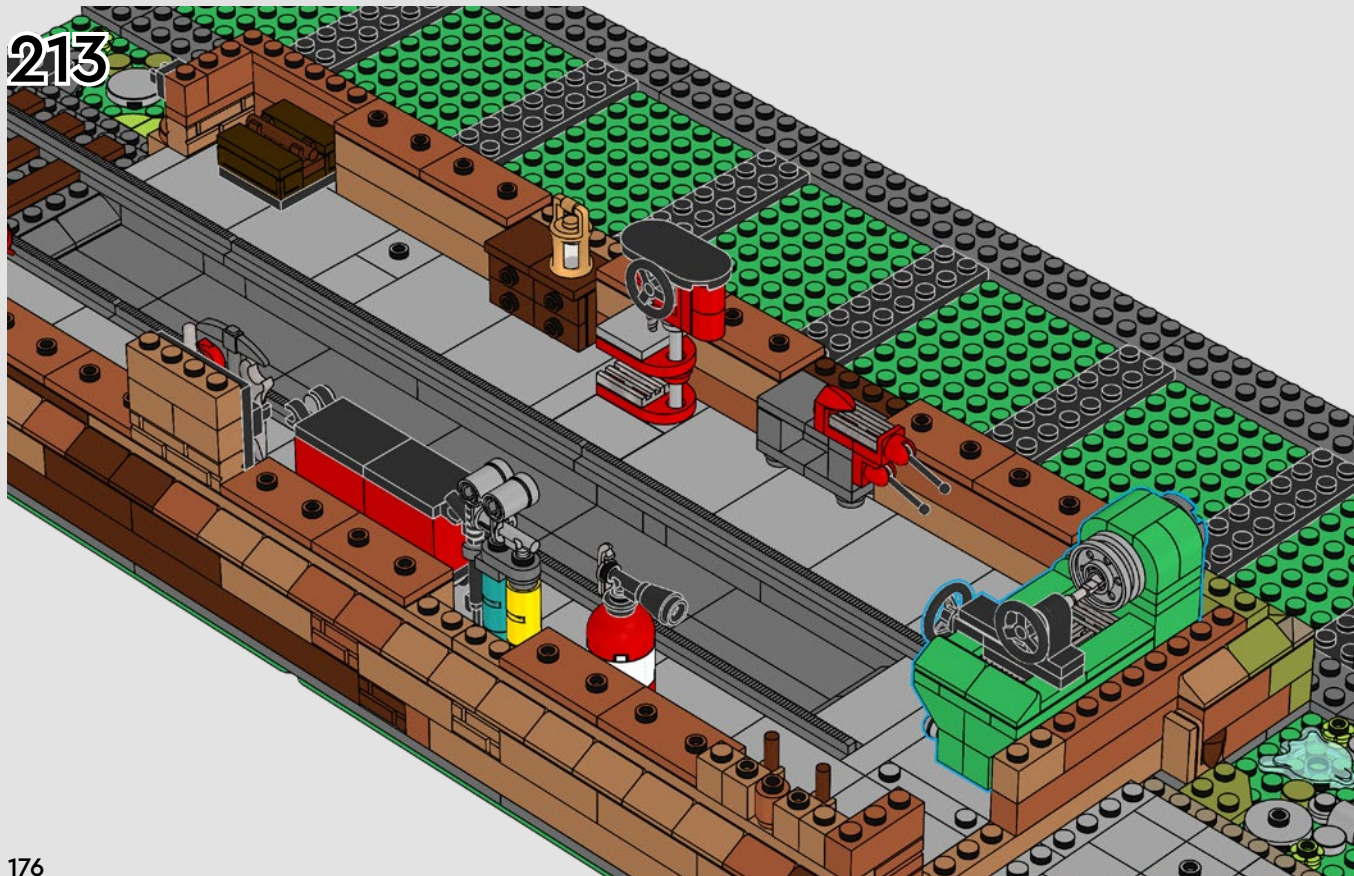

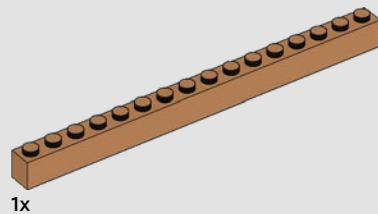
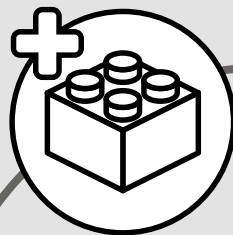

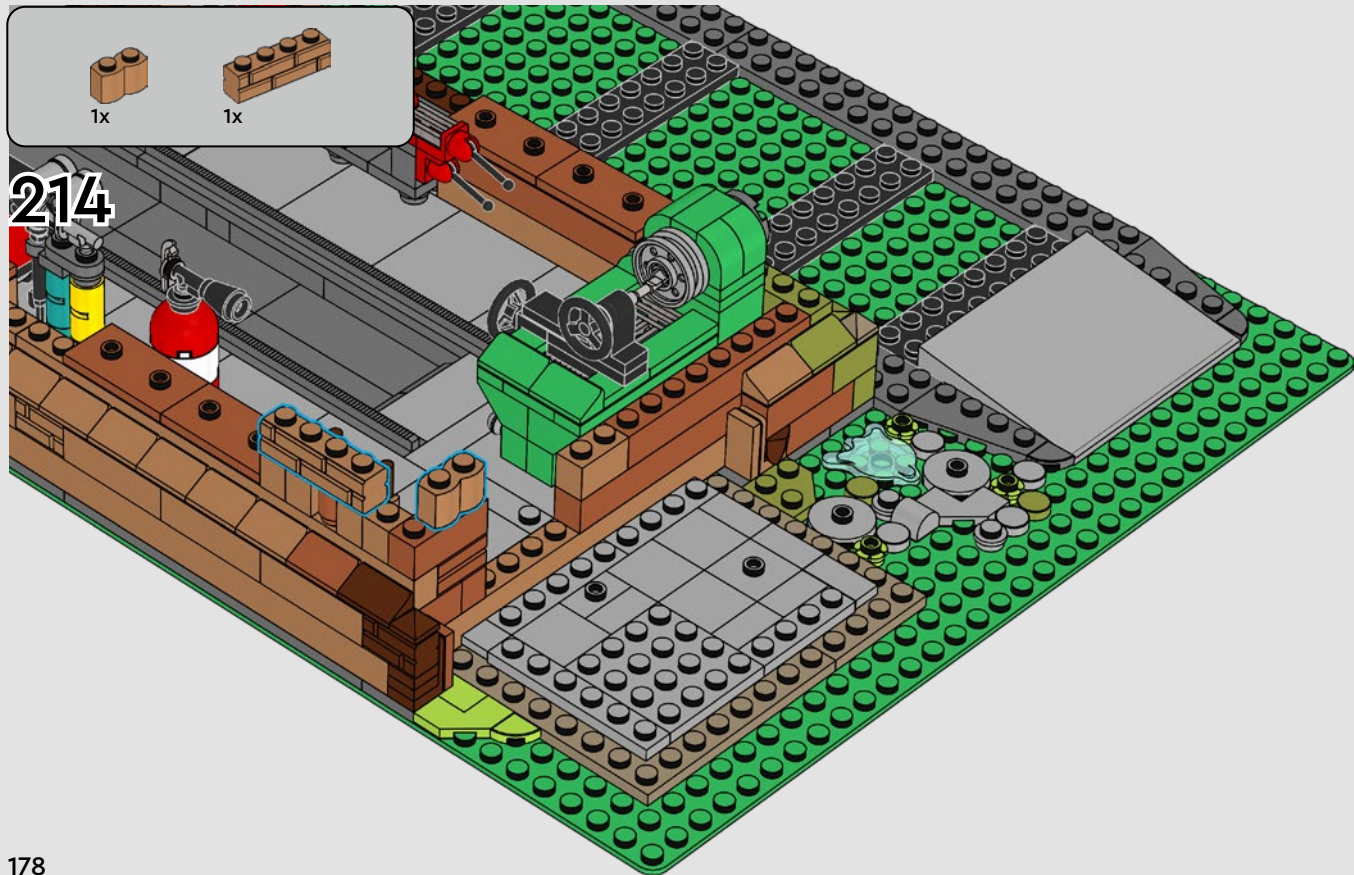

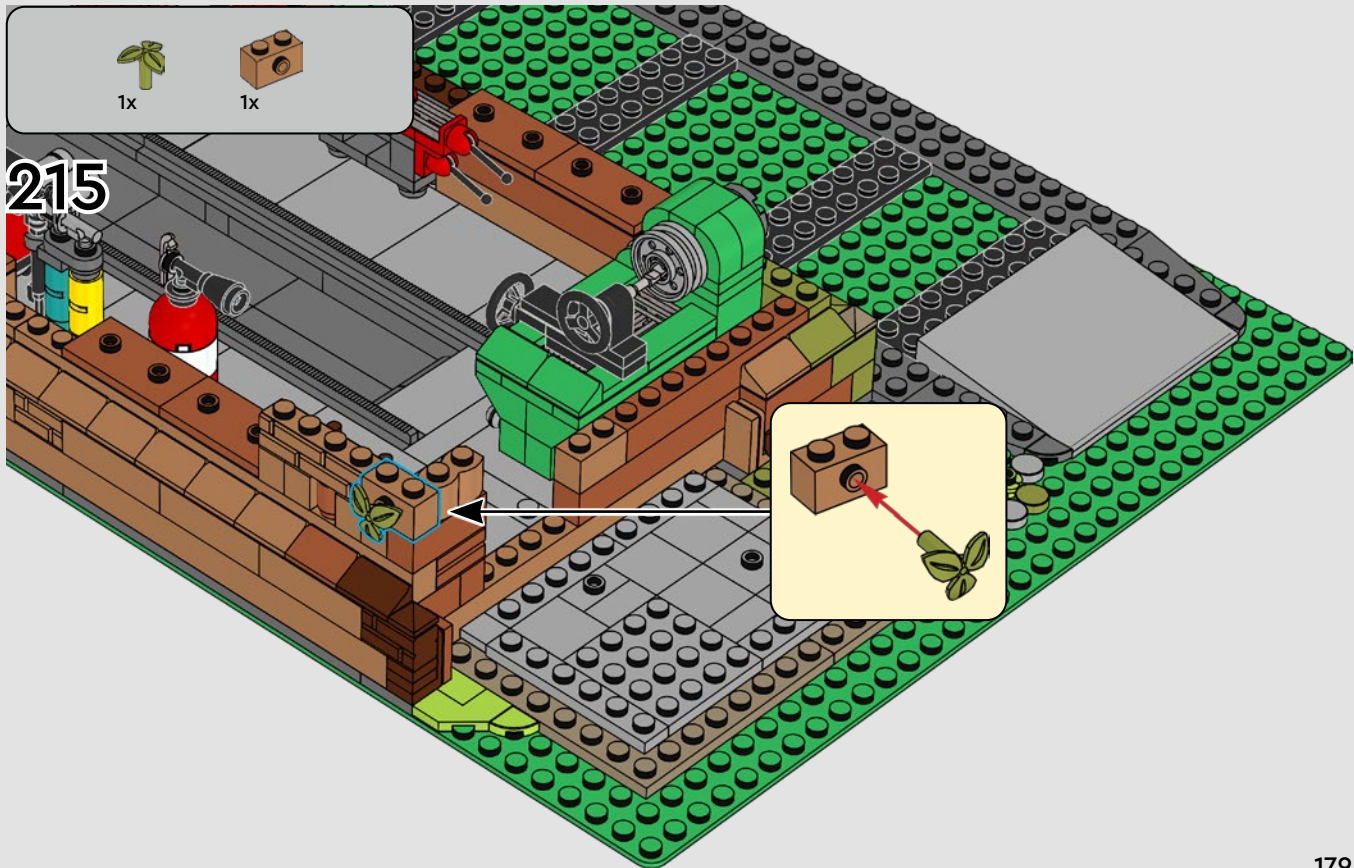

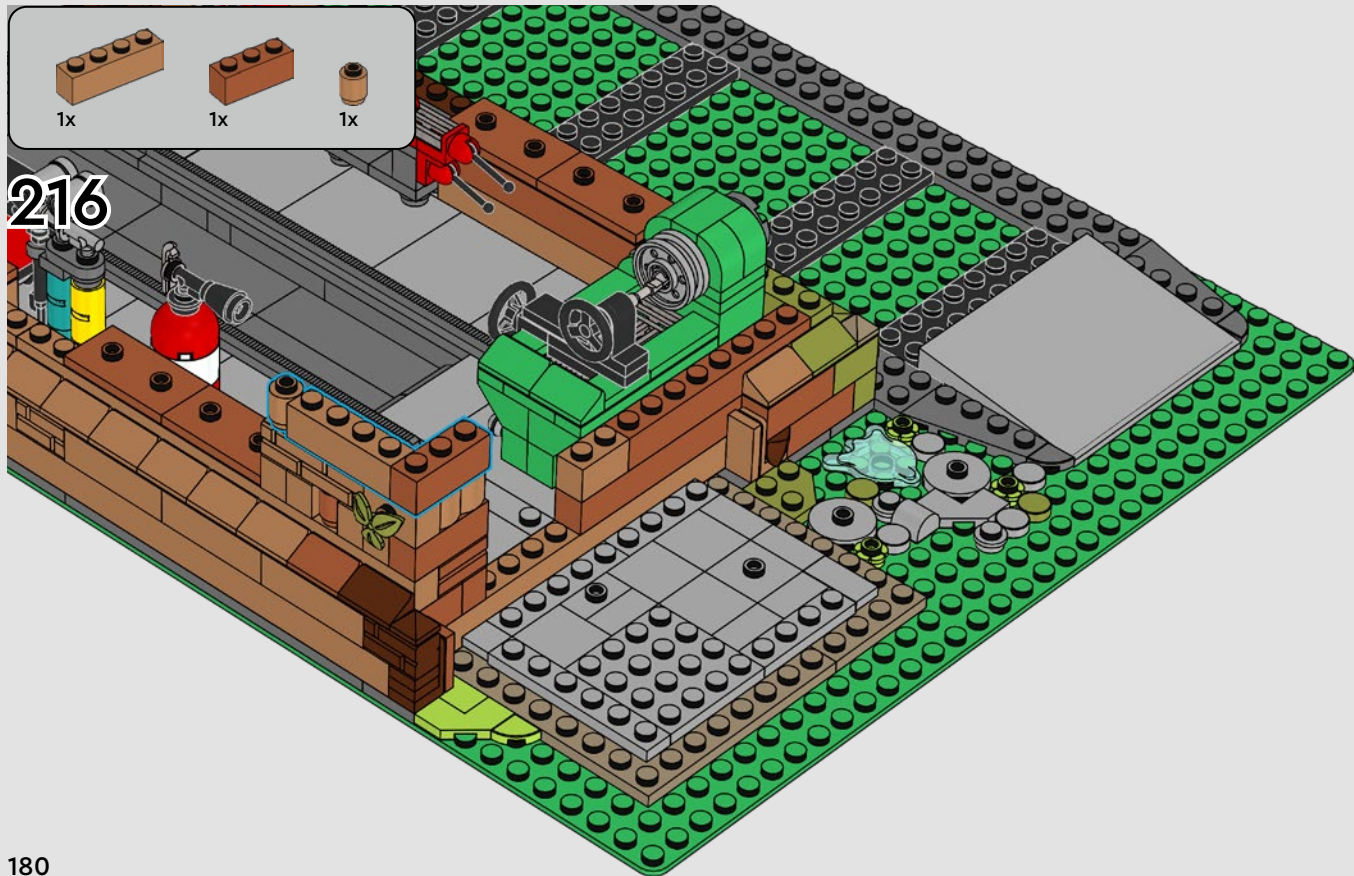

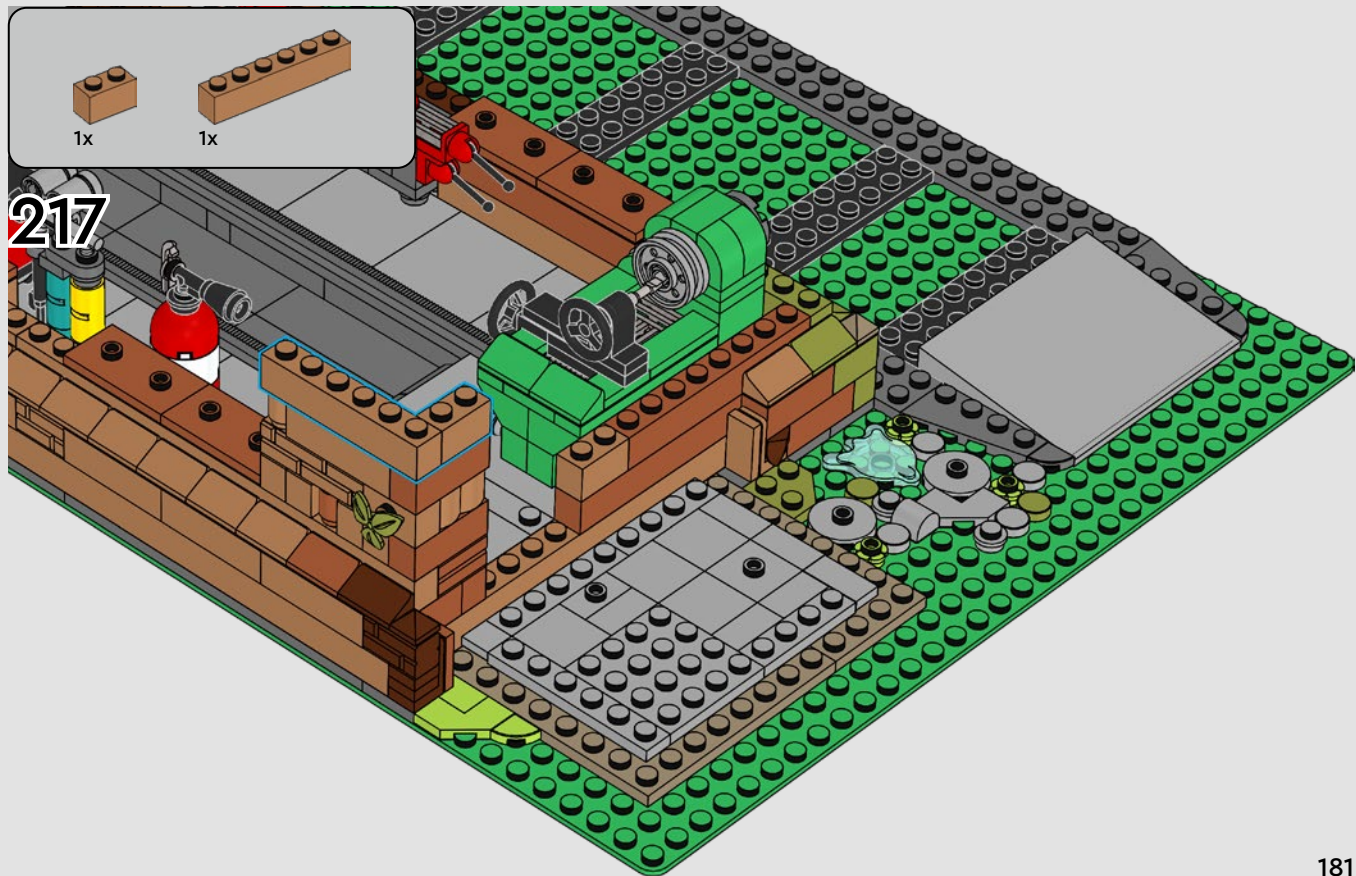

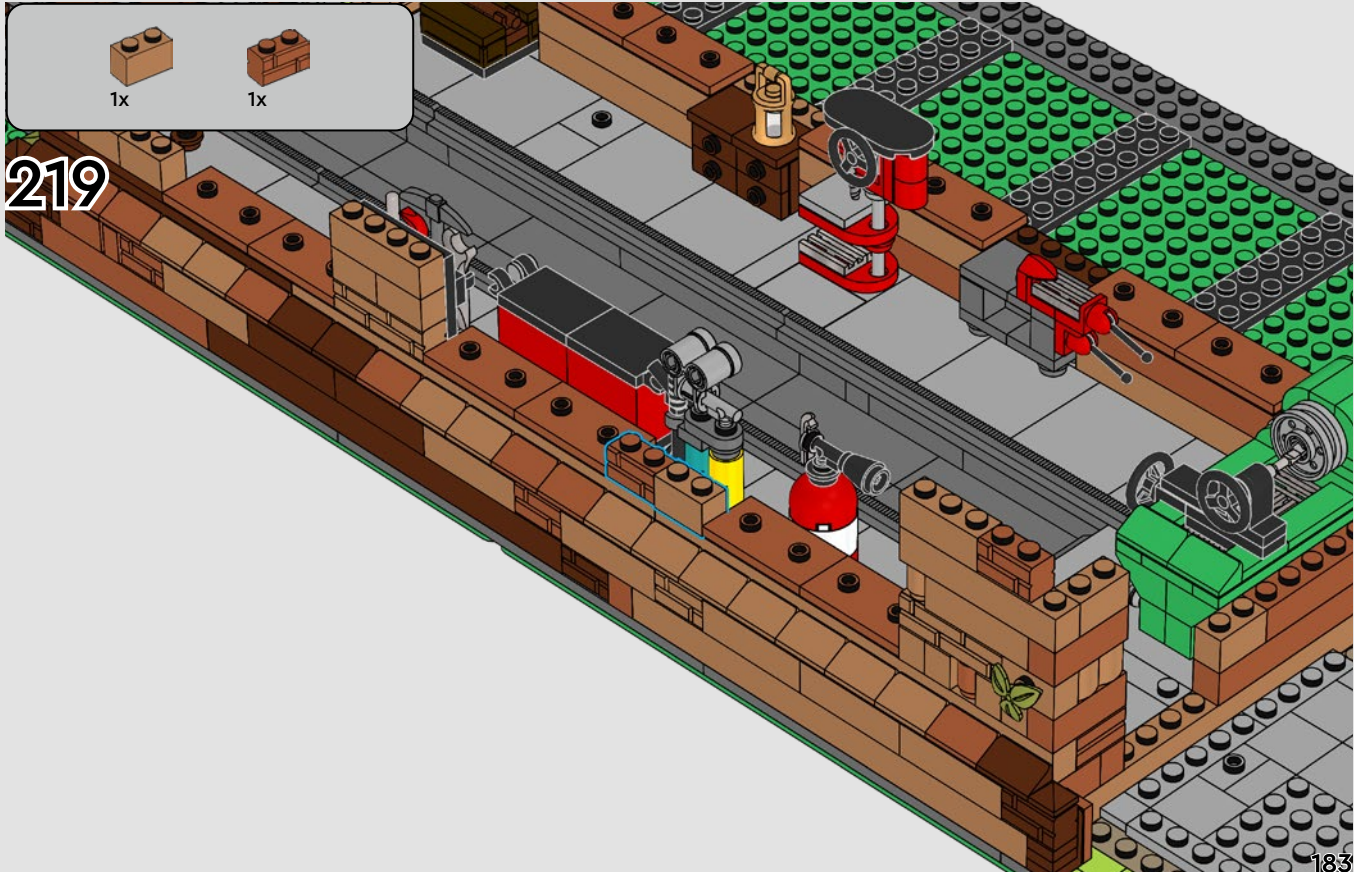

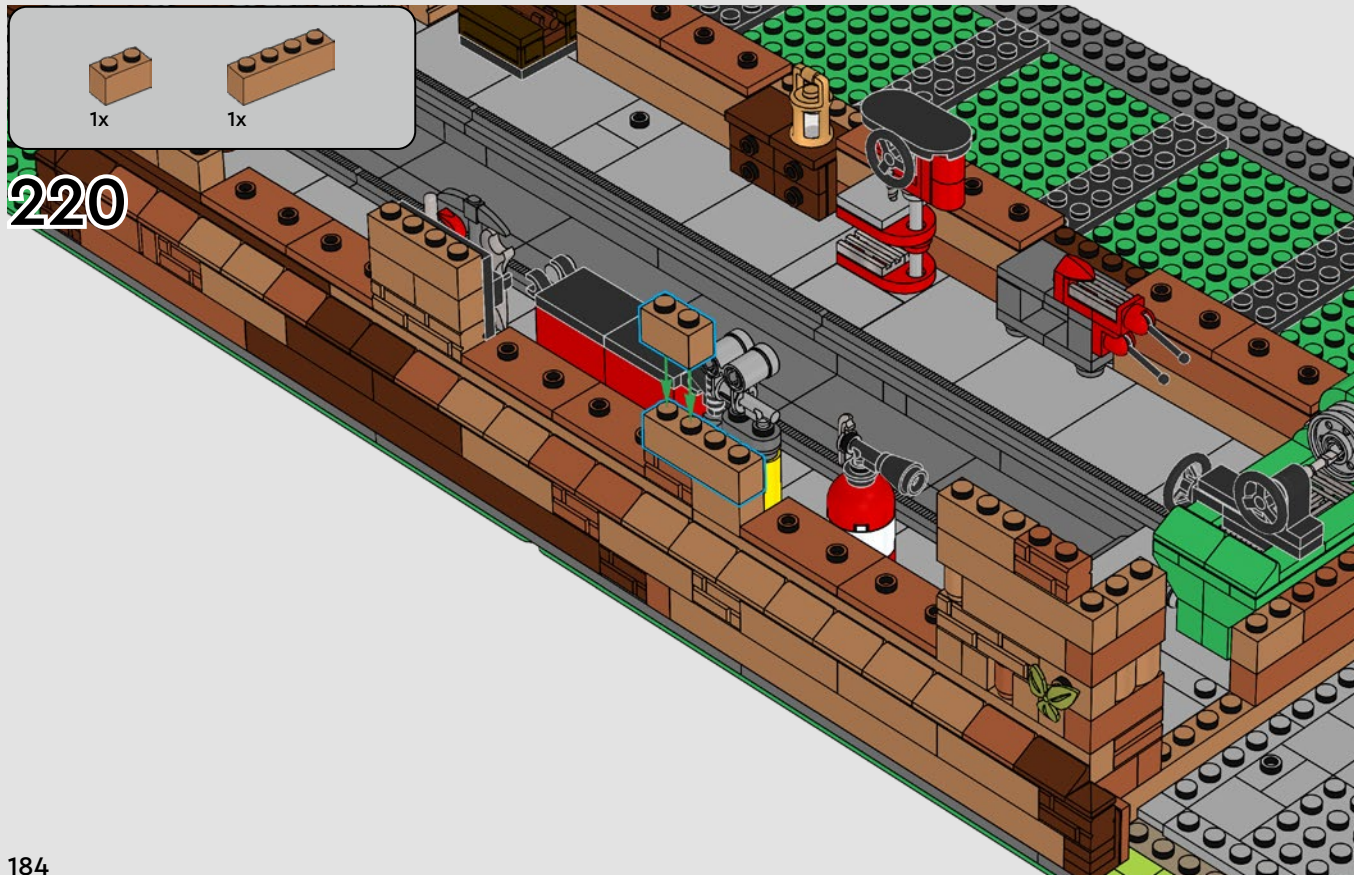

219



1x  1x 

221



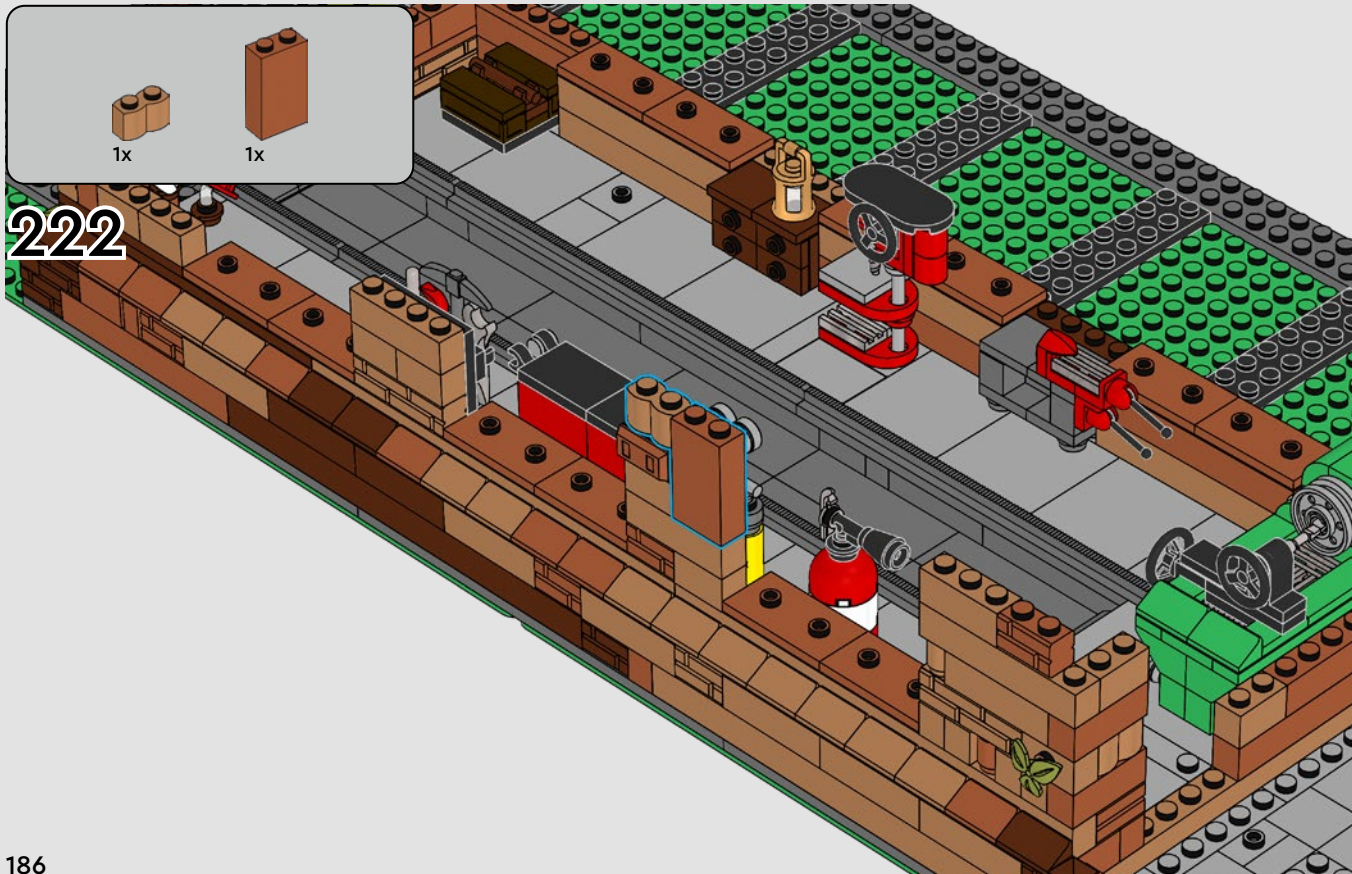

1x 1x 1x

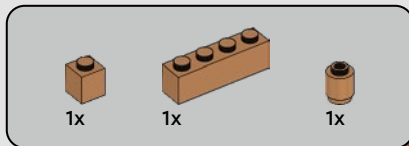

223

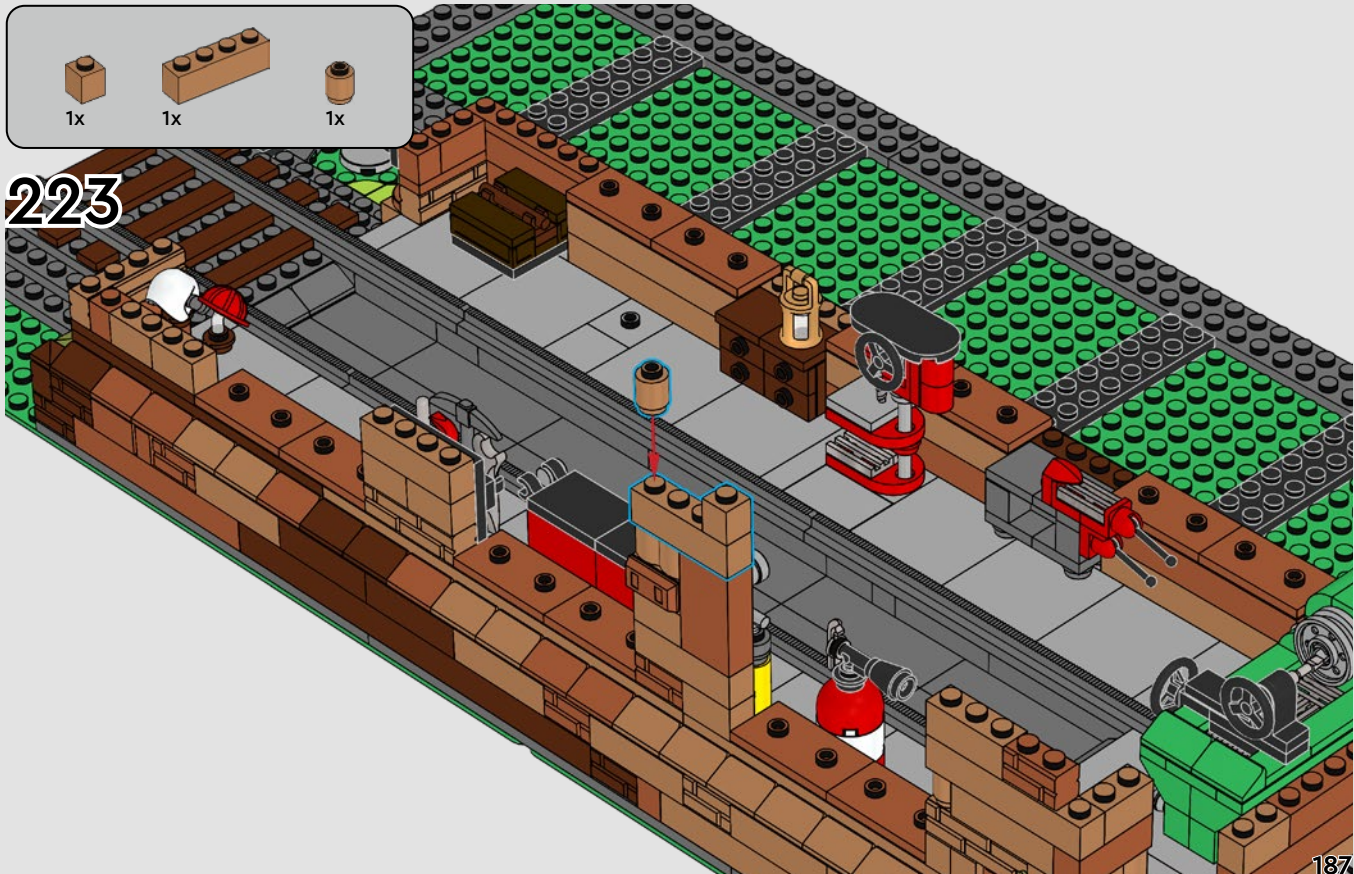



1x



1x

224

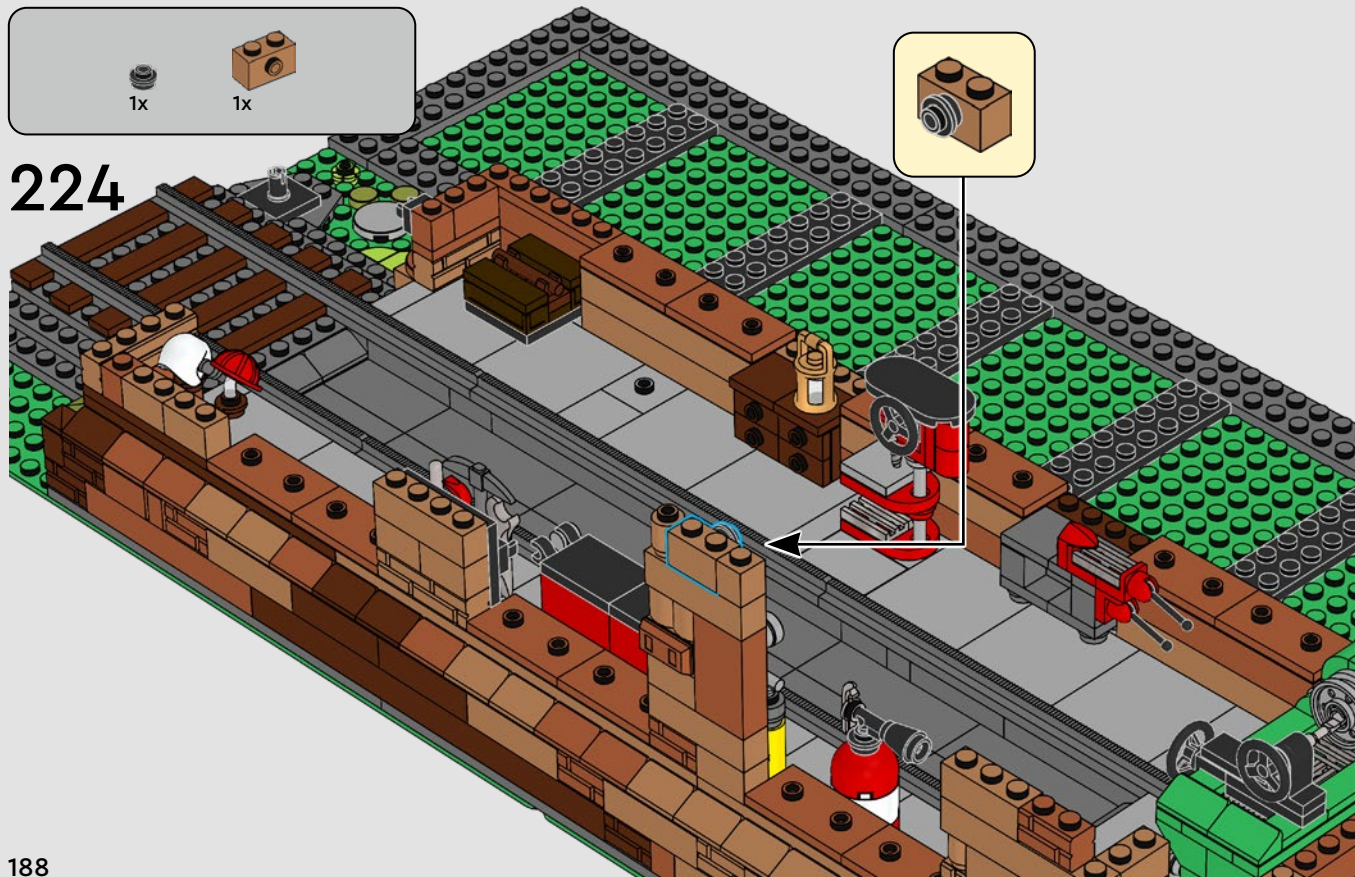

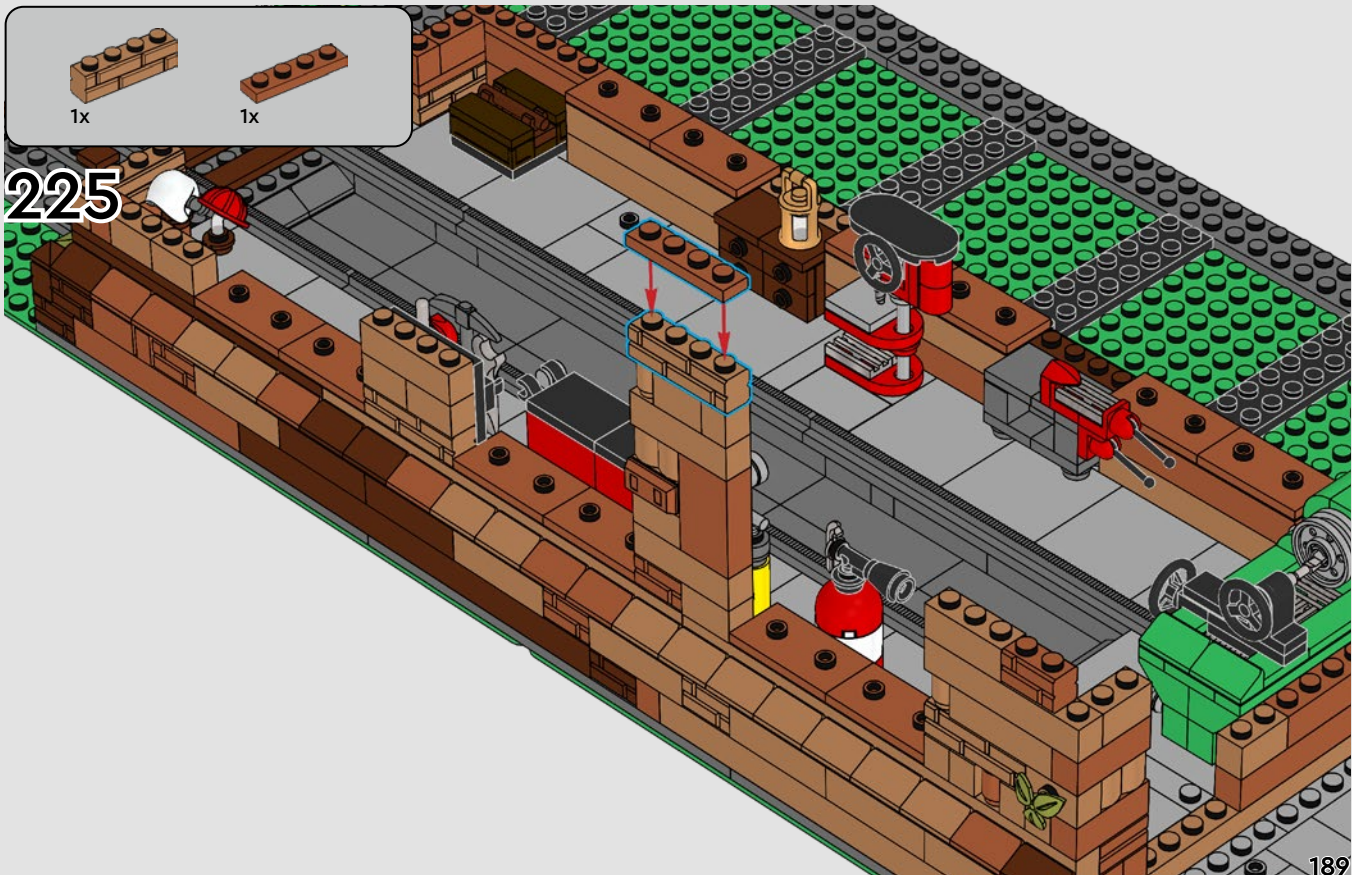

225

1x

1x



2x

226

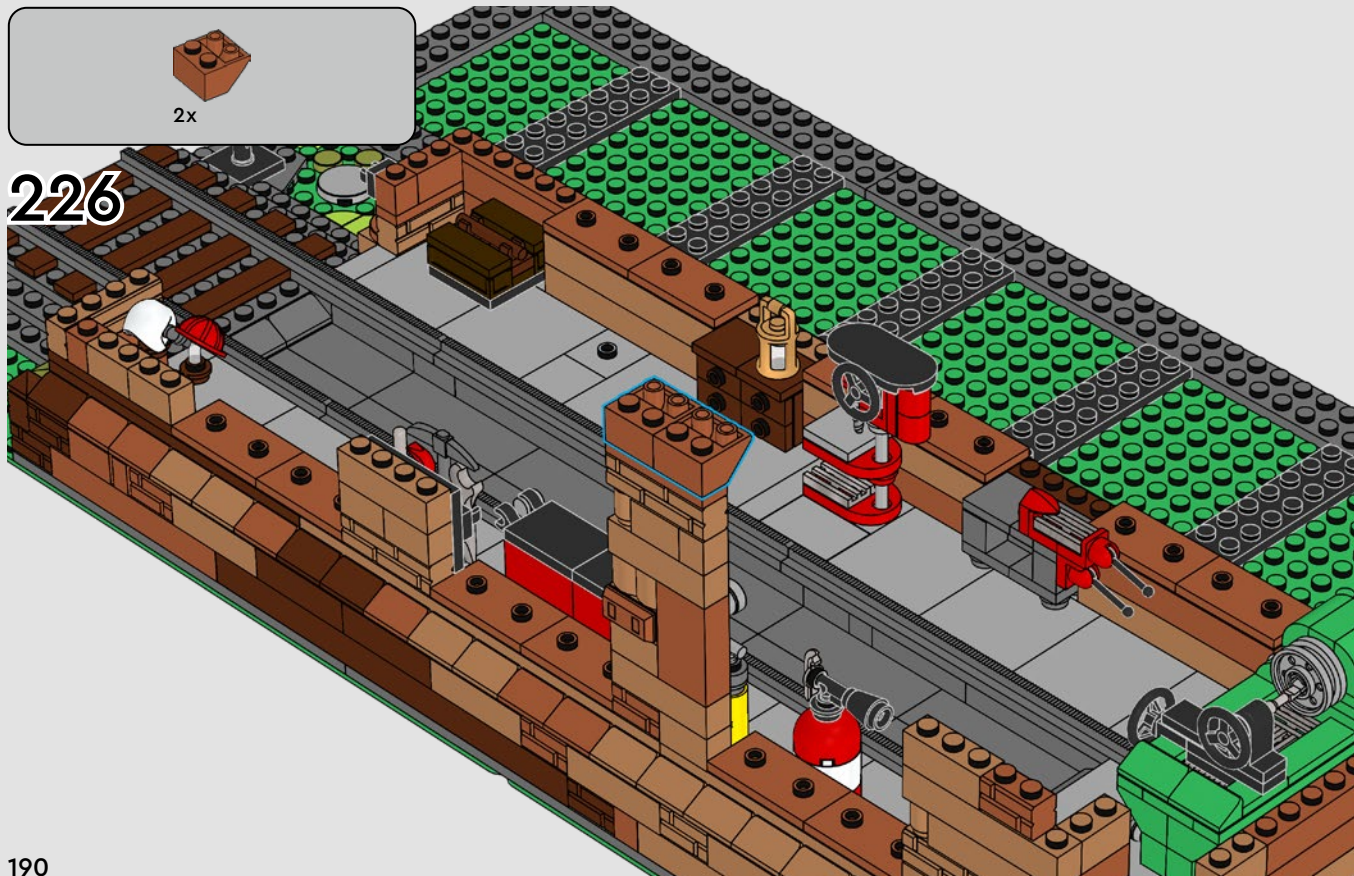

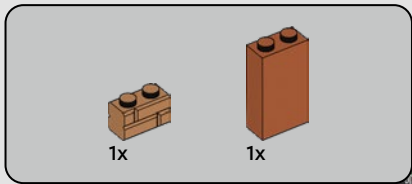

227

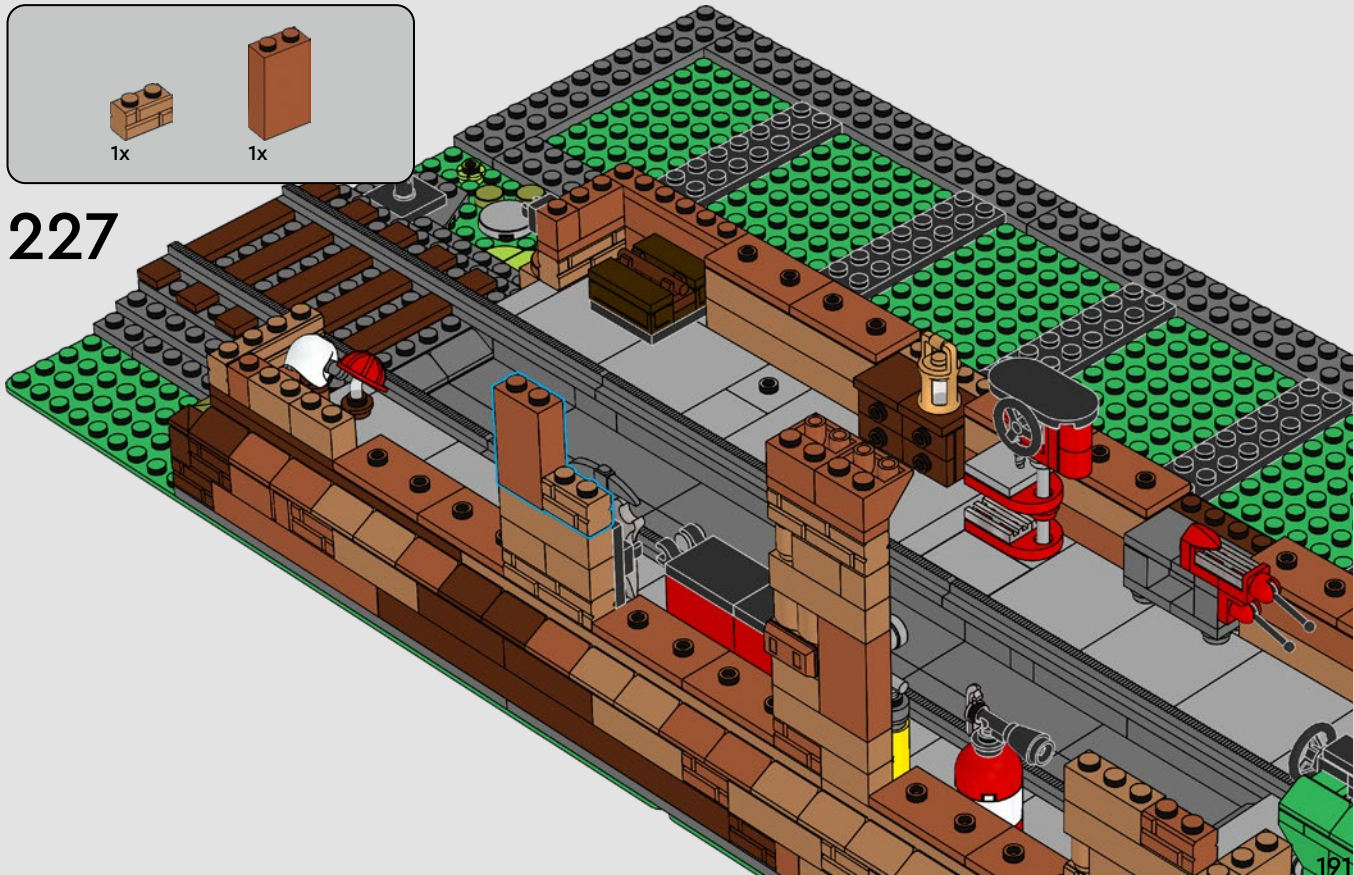



1x



1x

228

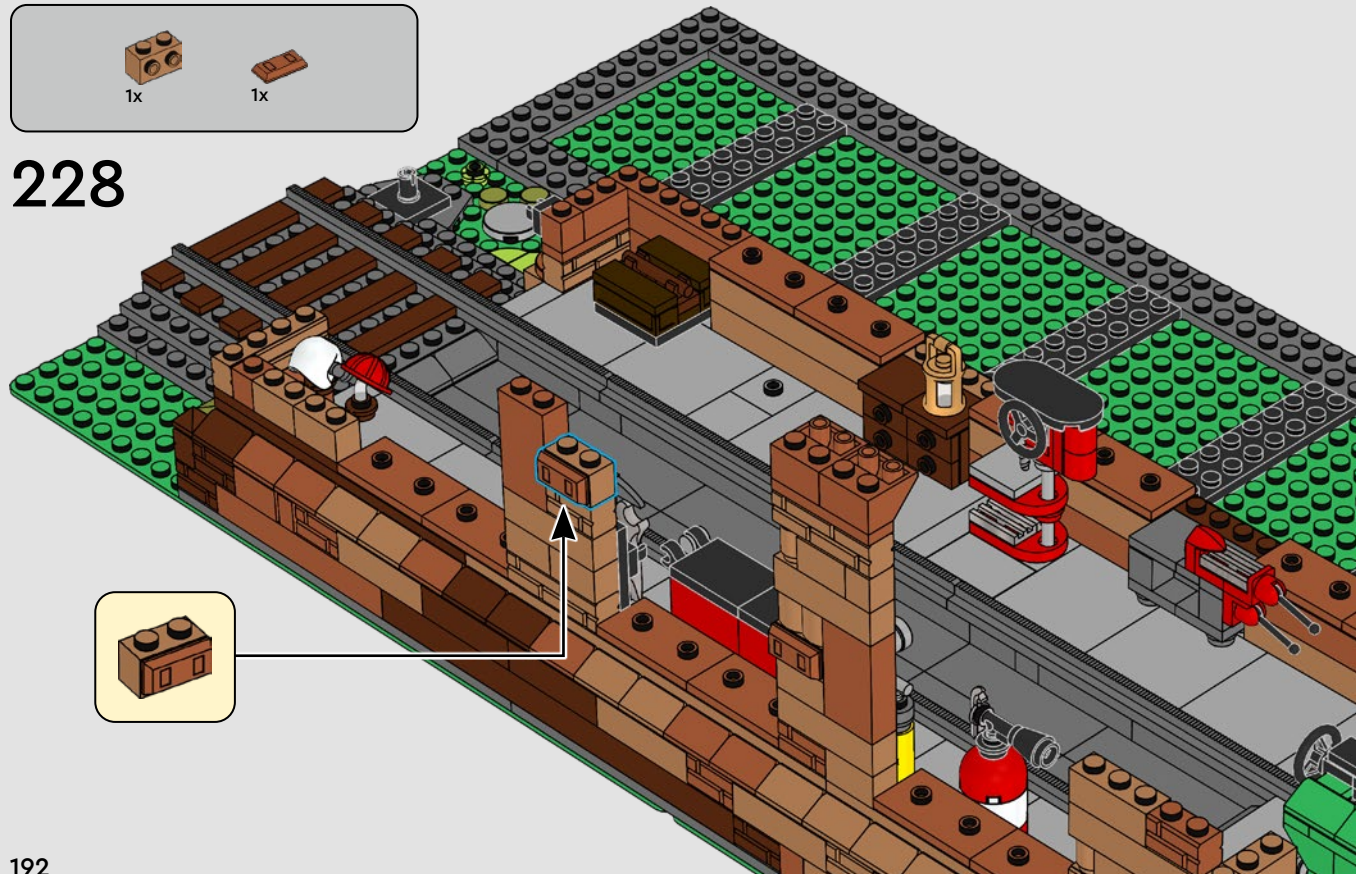



1x



1x



1x

229

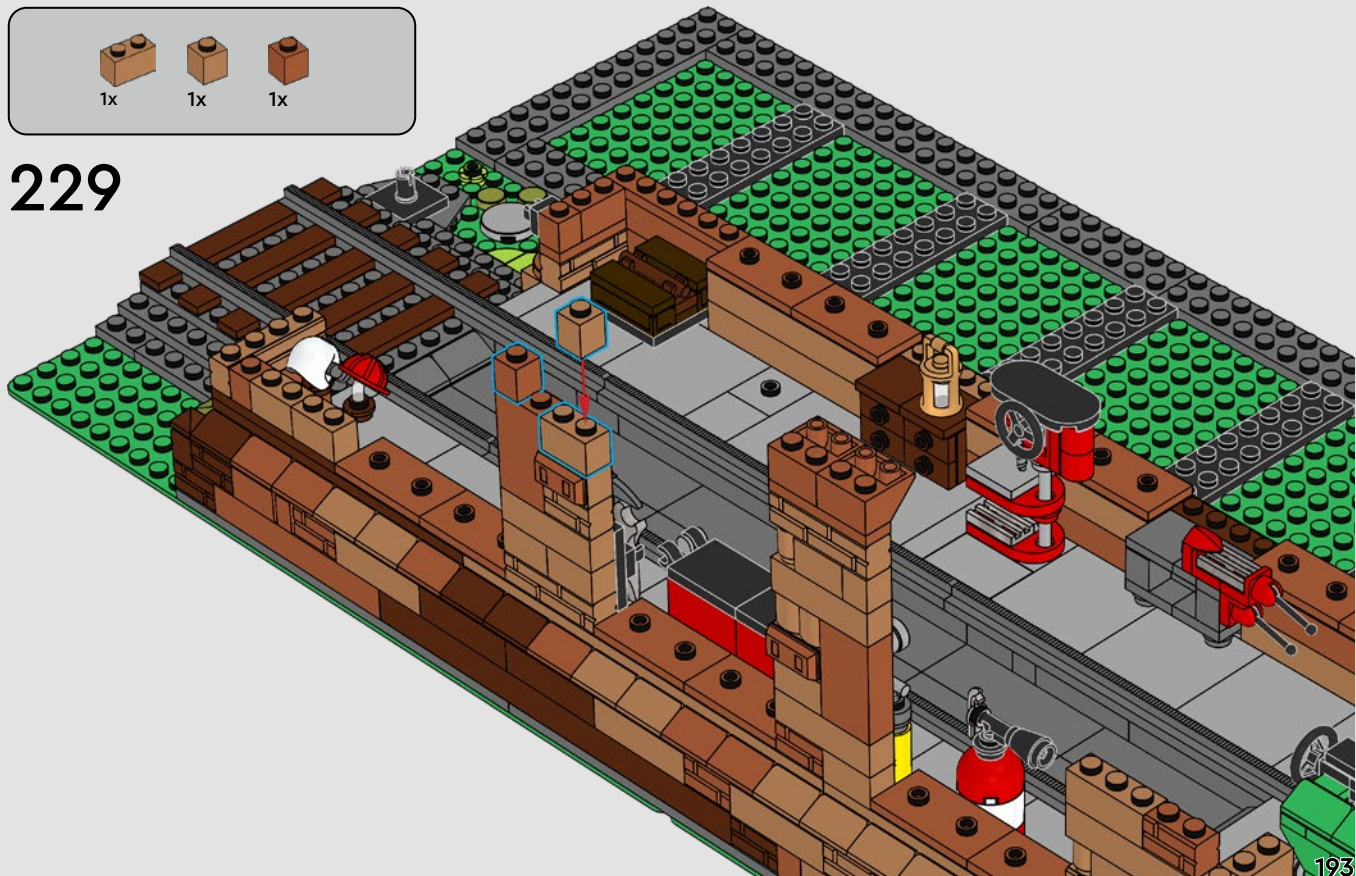



1x



1x

230

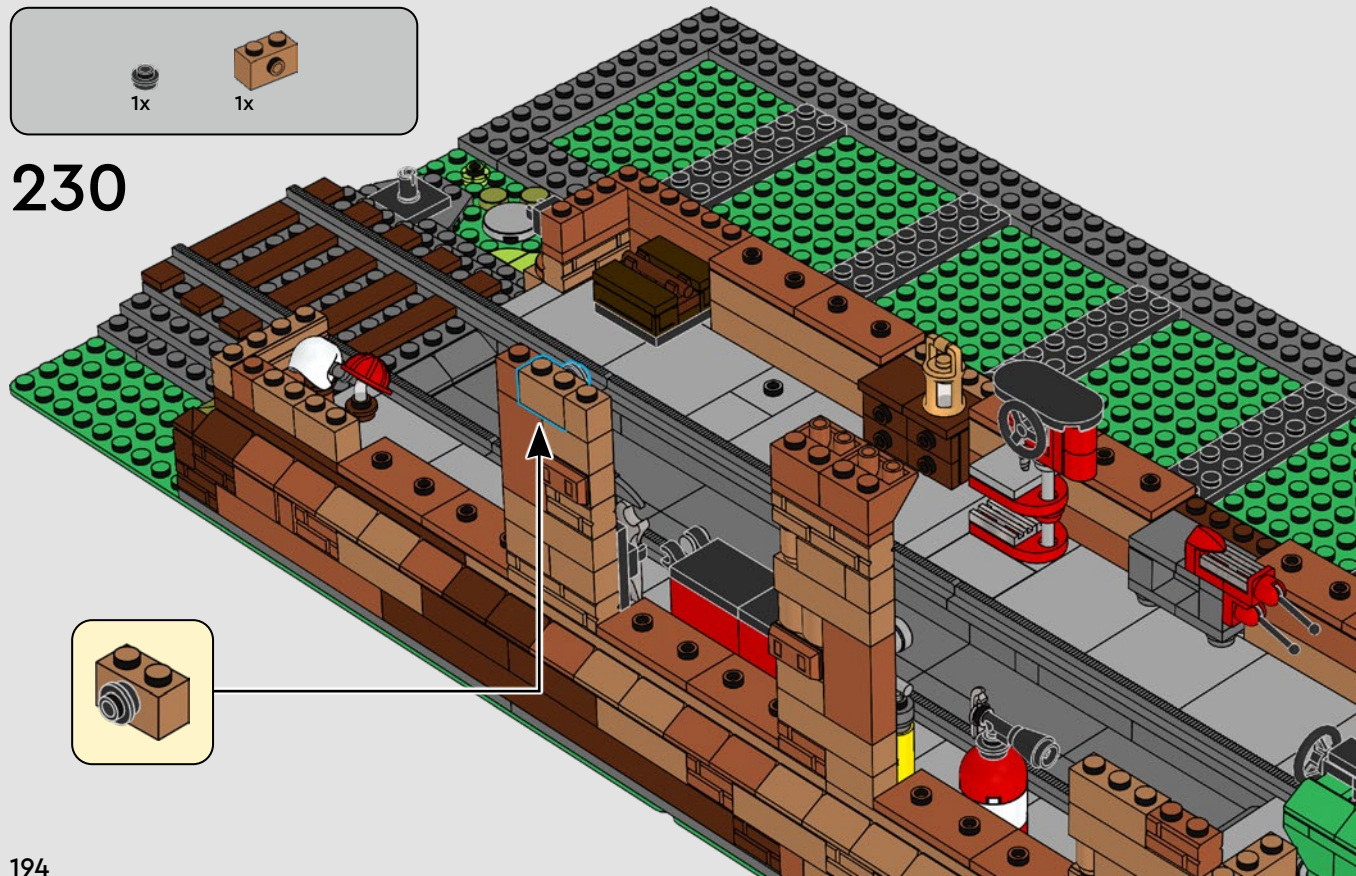

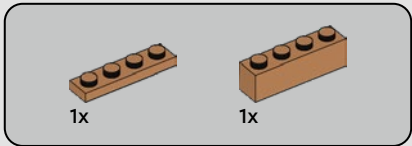

231

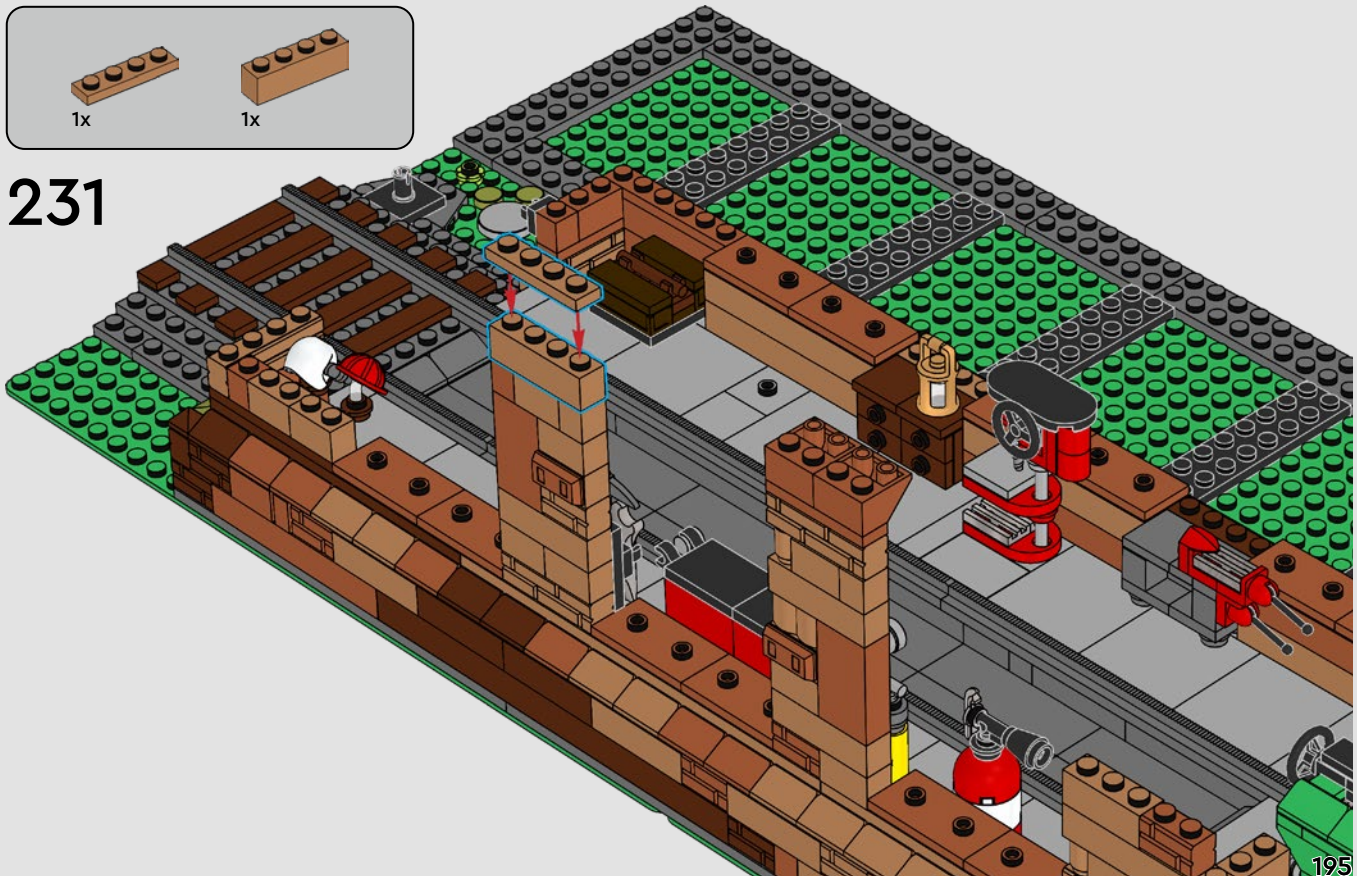



2x

232

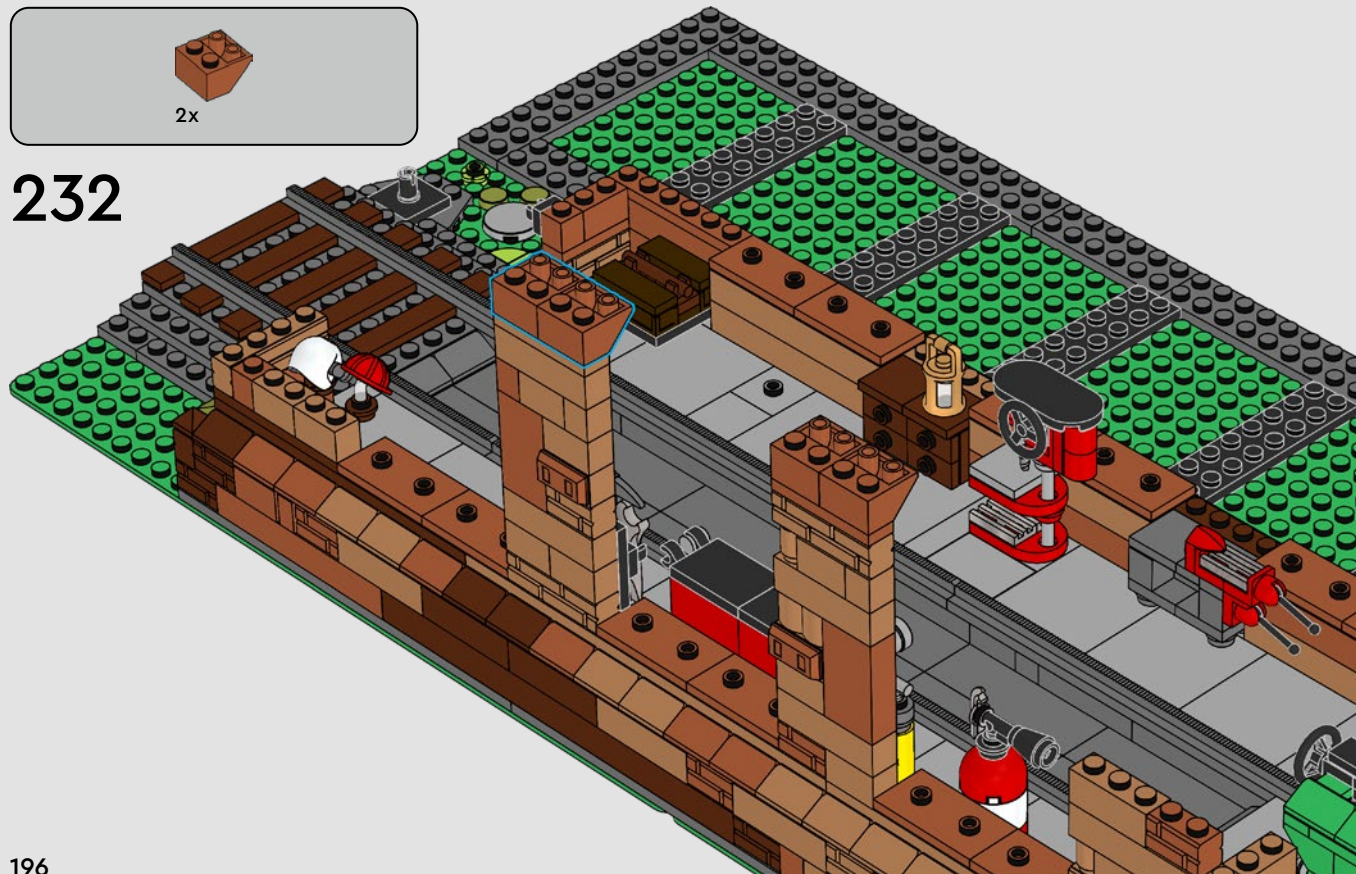

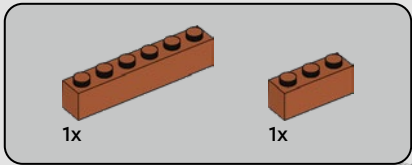

233

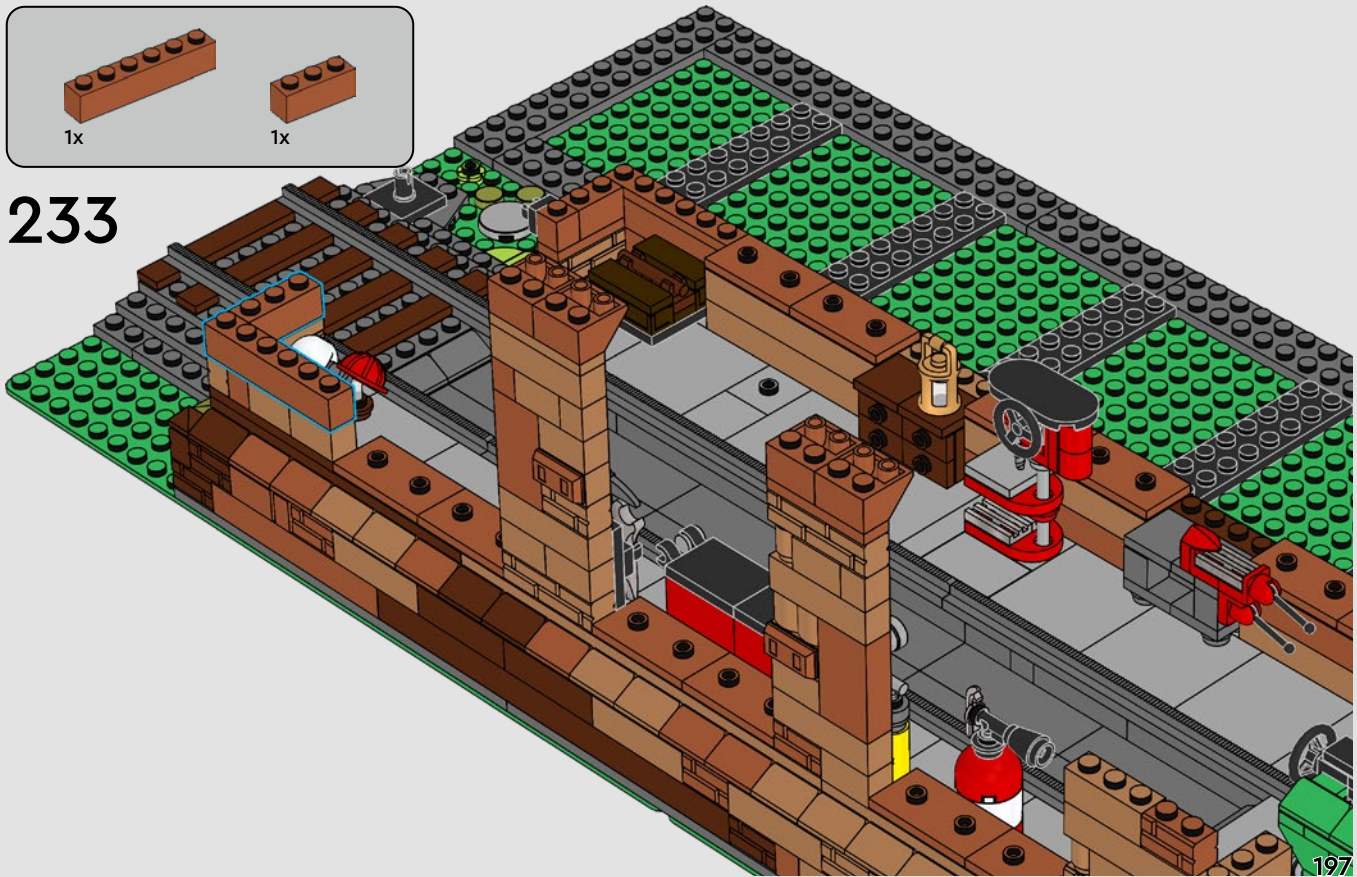

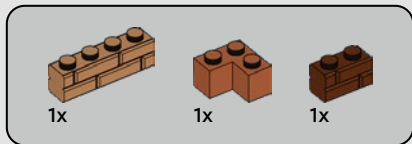

234

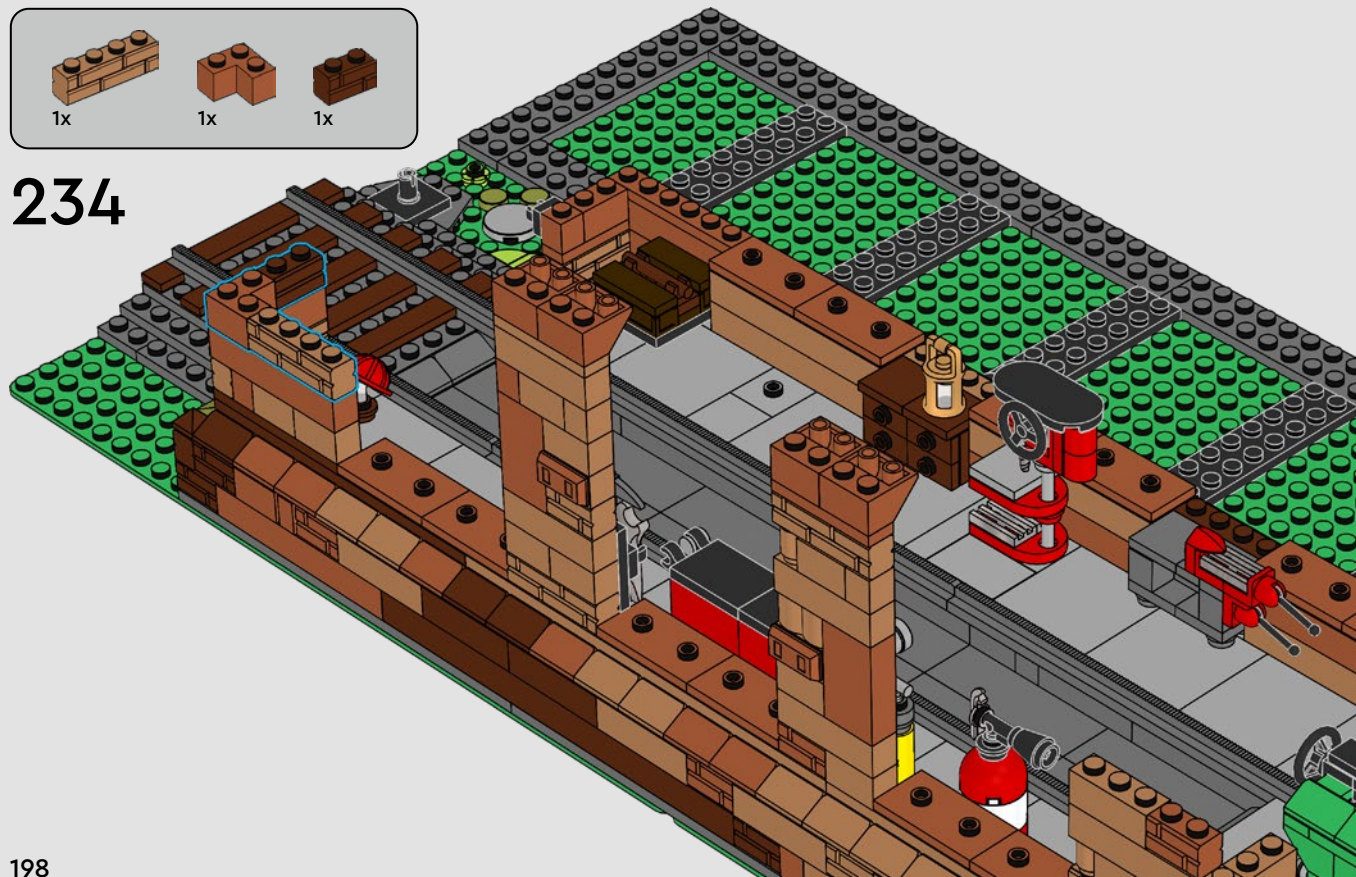

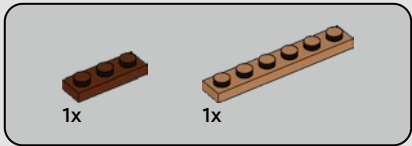

235

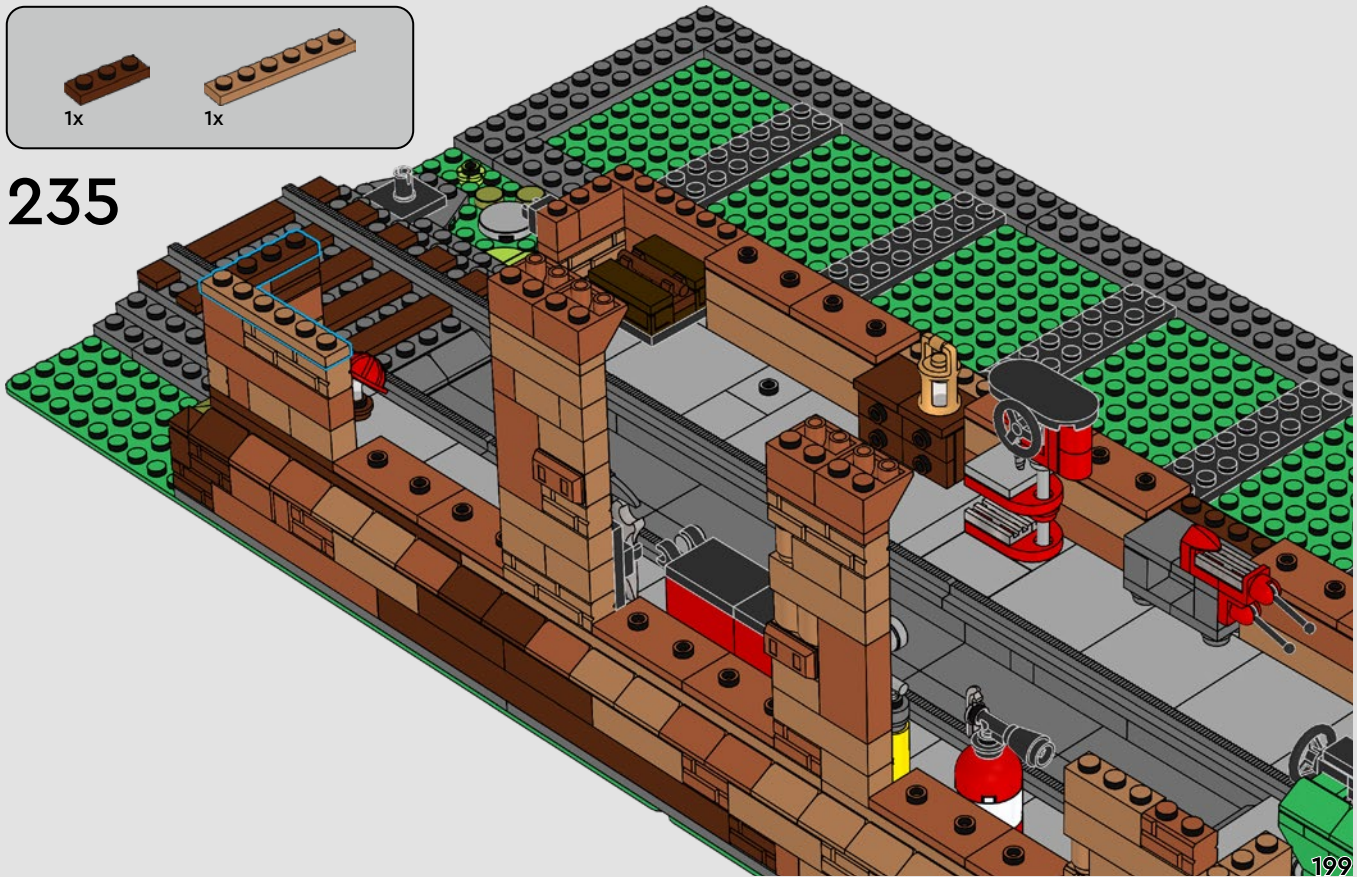

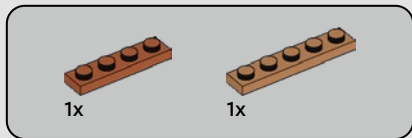

236

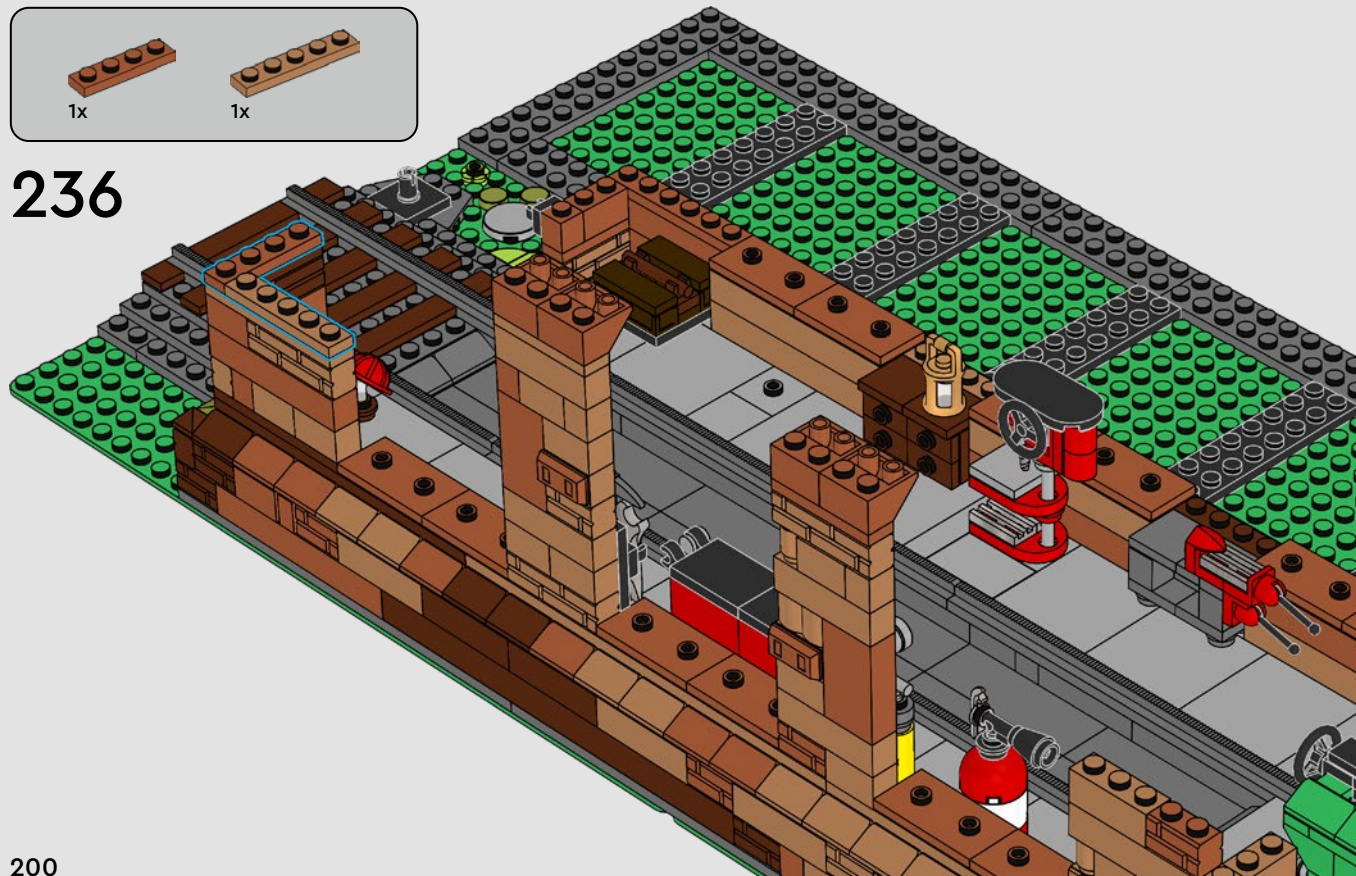

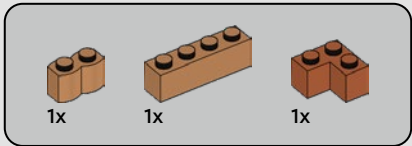

237

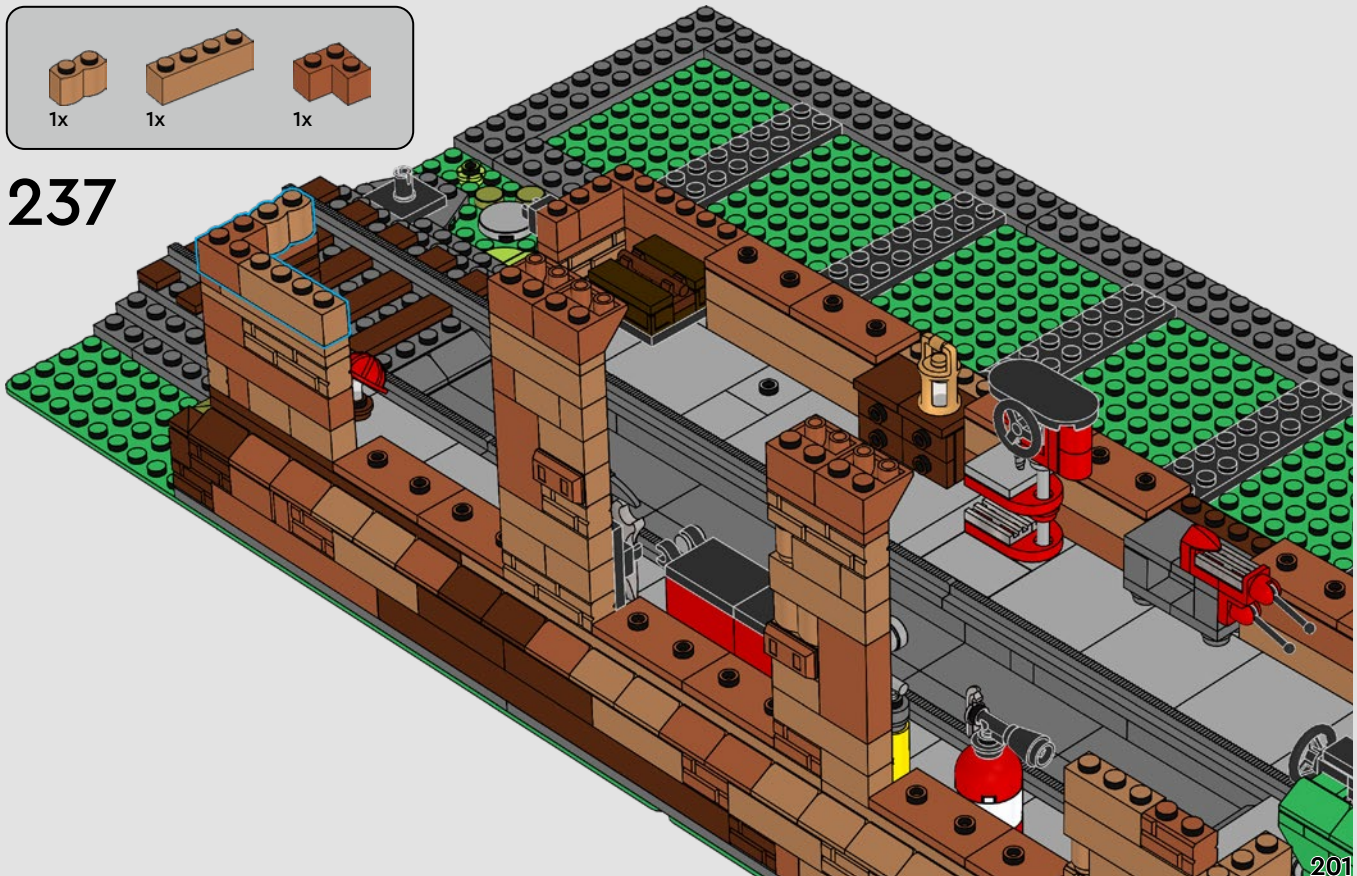



1x



1x

239

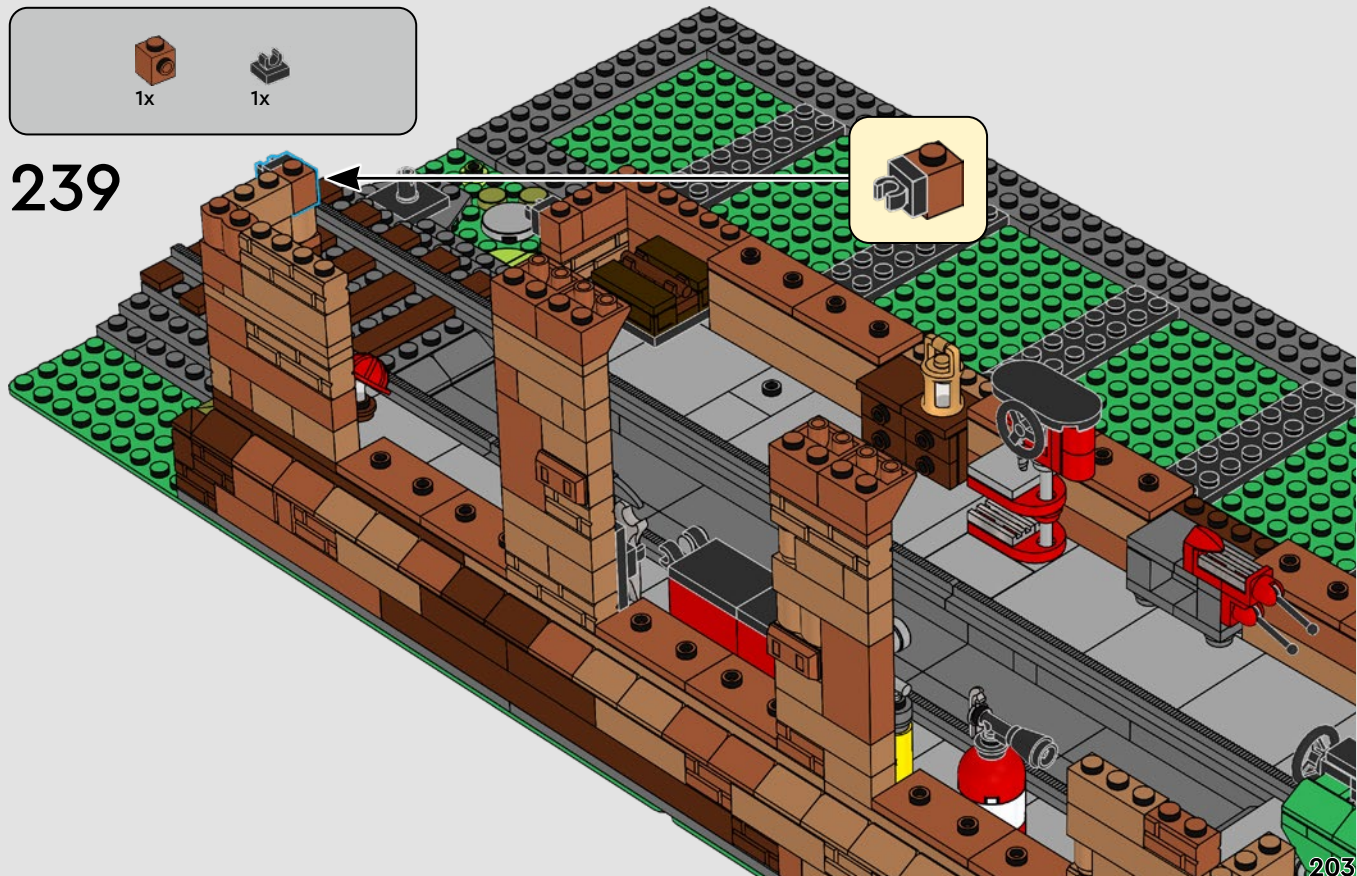

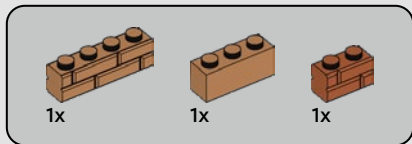

240



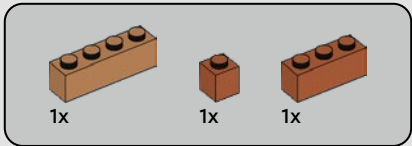

241

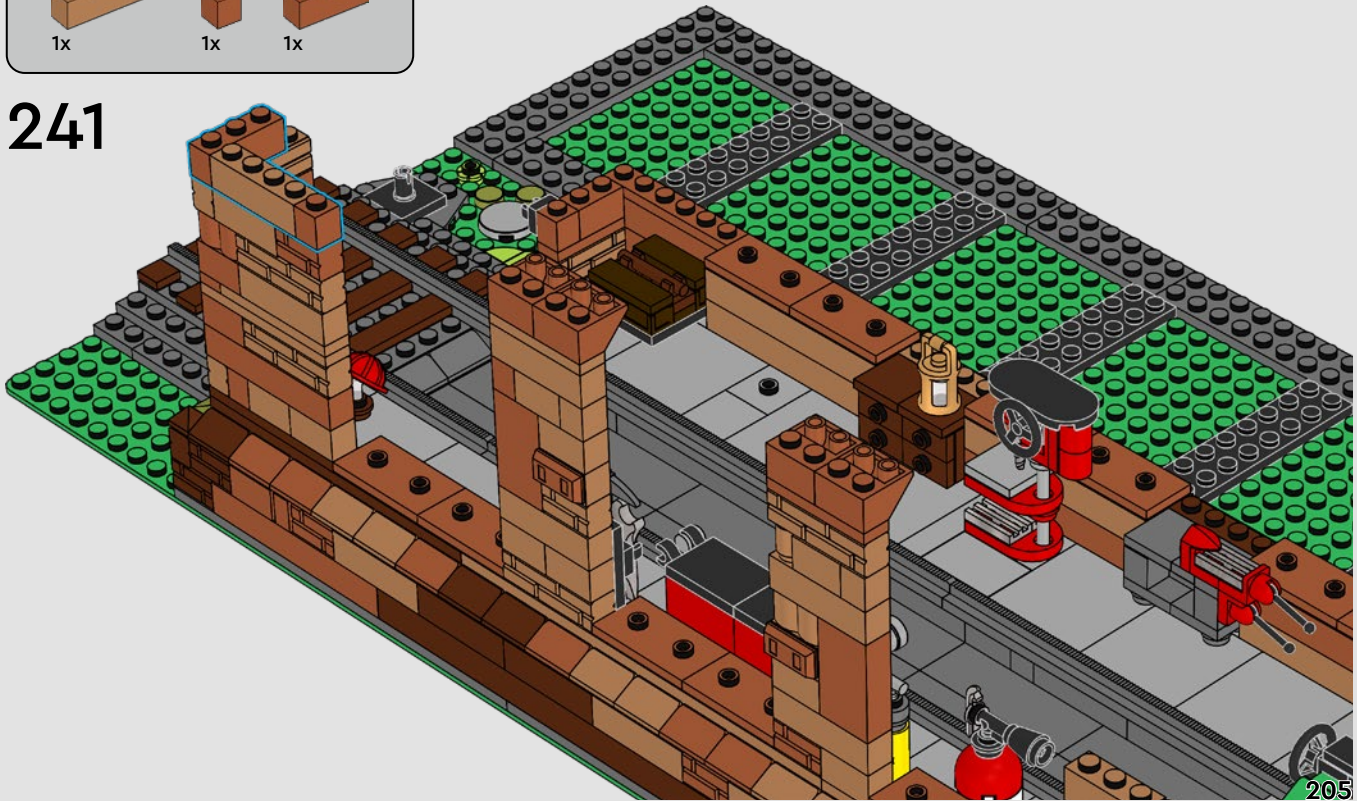

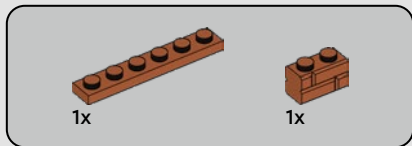

242

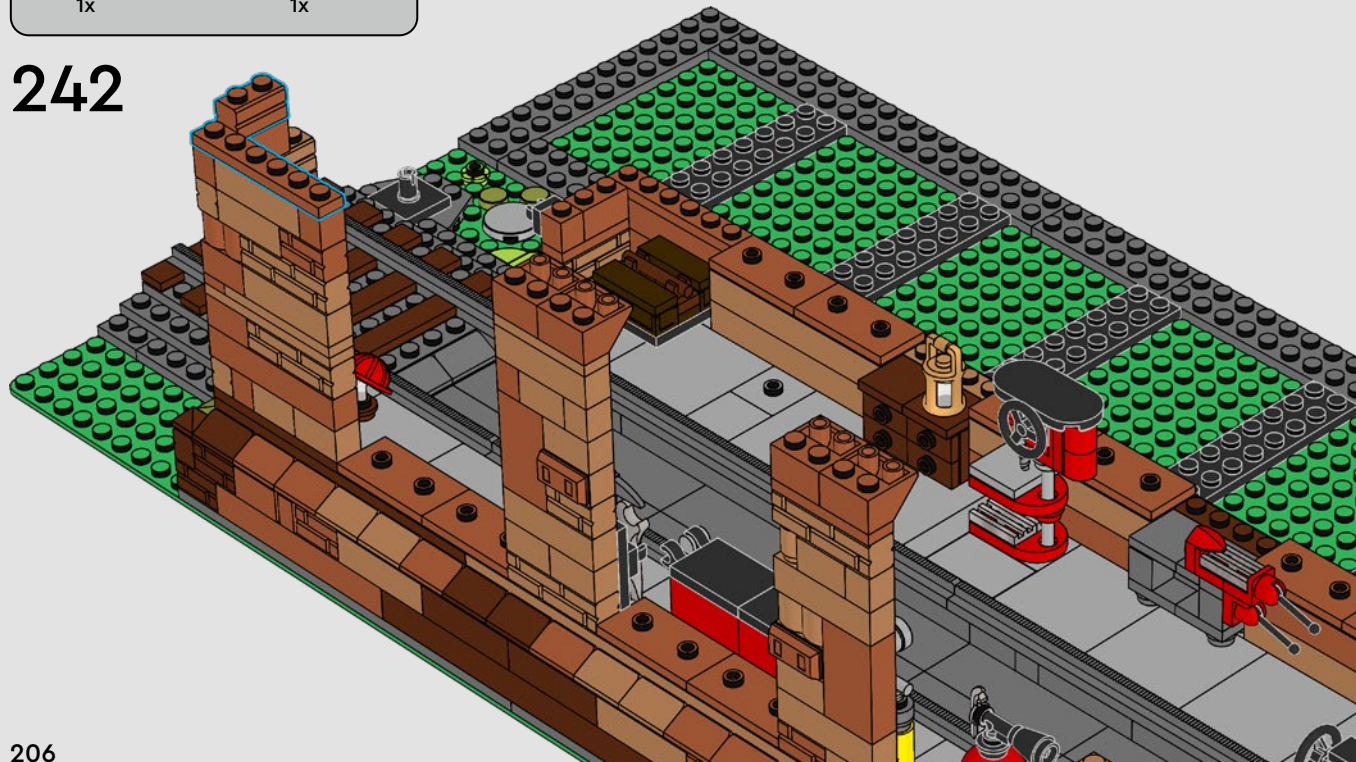



1x



1x

243





1x



2x

244



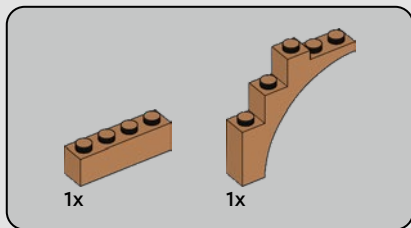

245

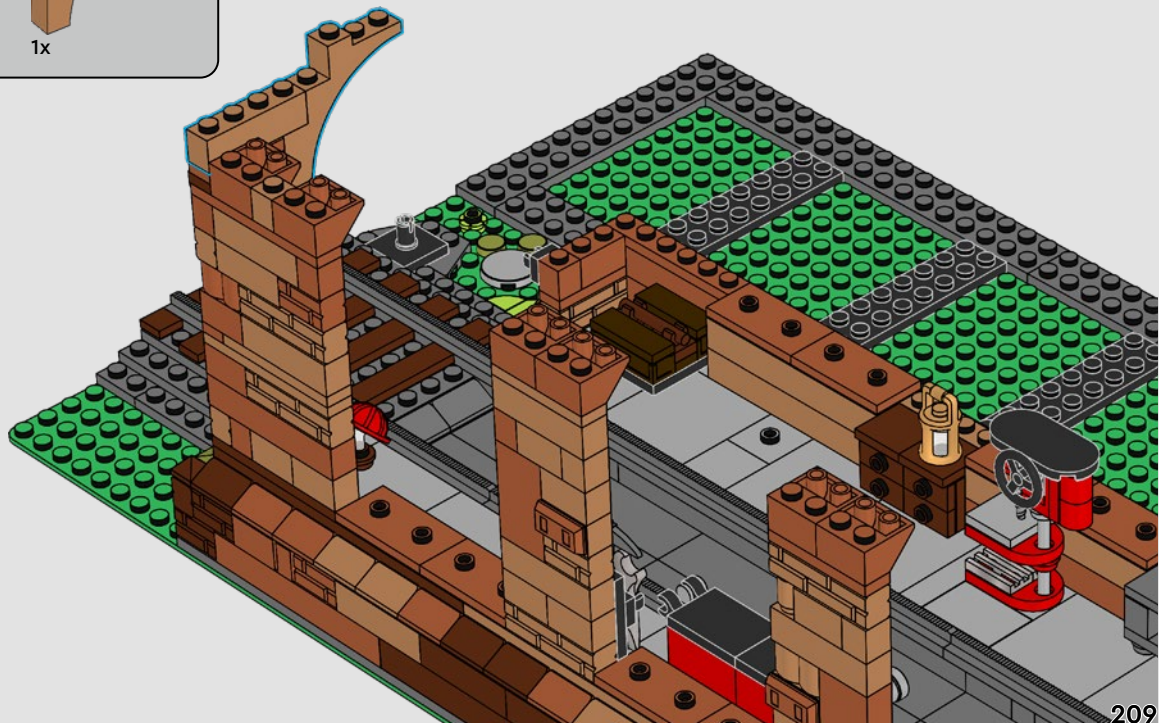

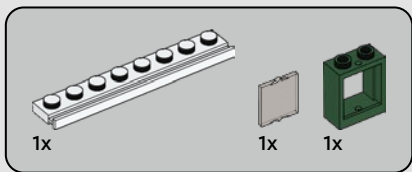
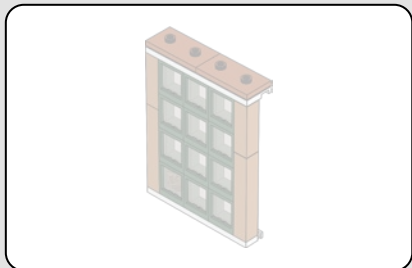

246

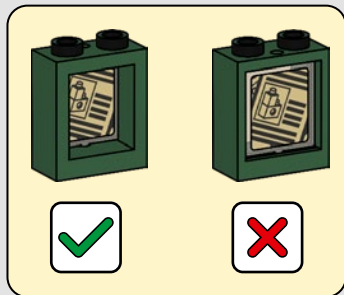
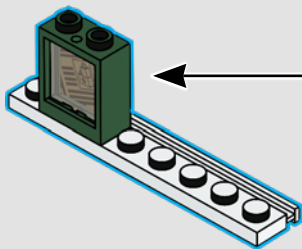
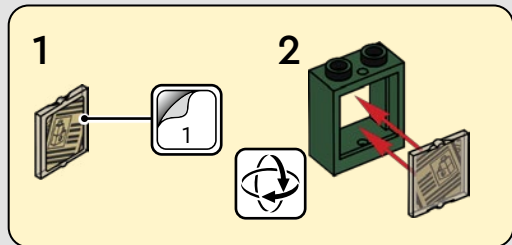

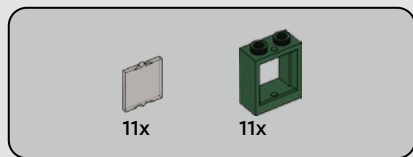

247

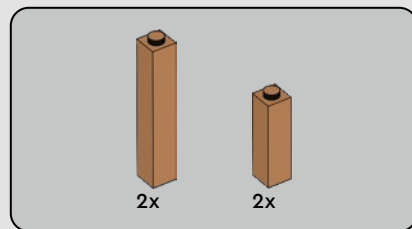
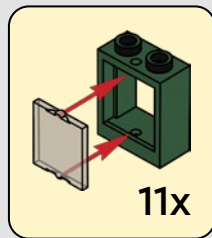
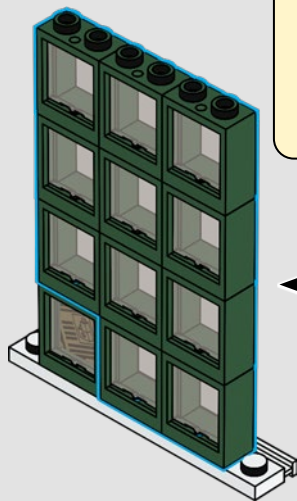

248

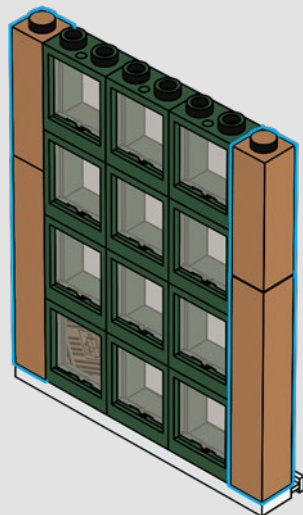

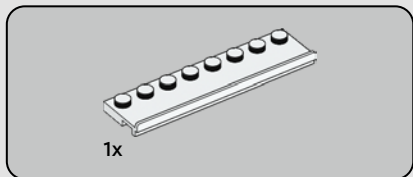

249

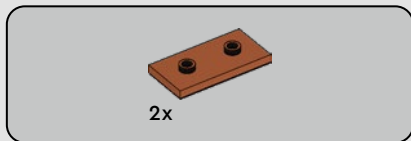
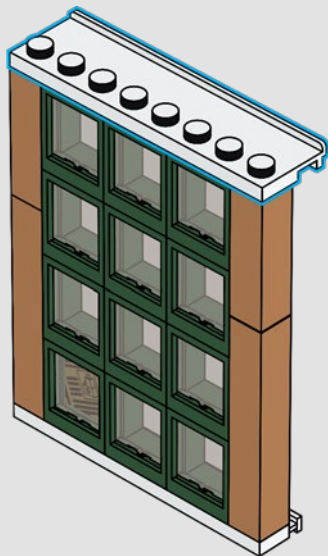

250

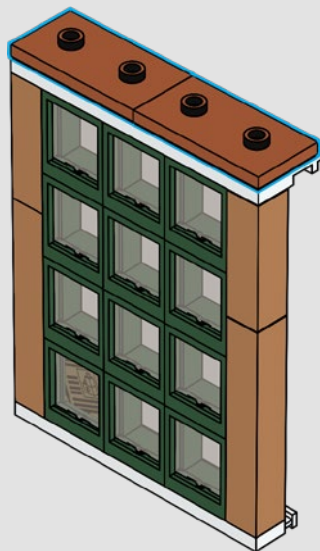

251

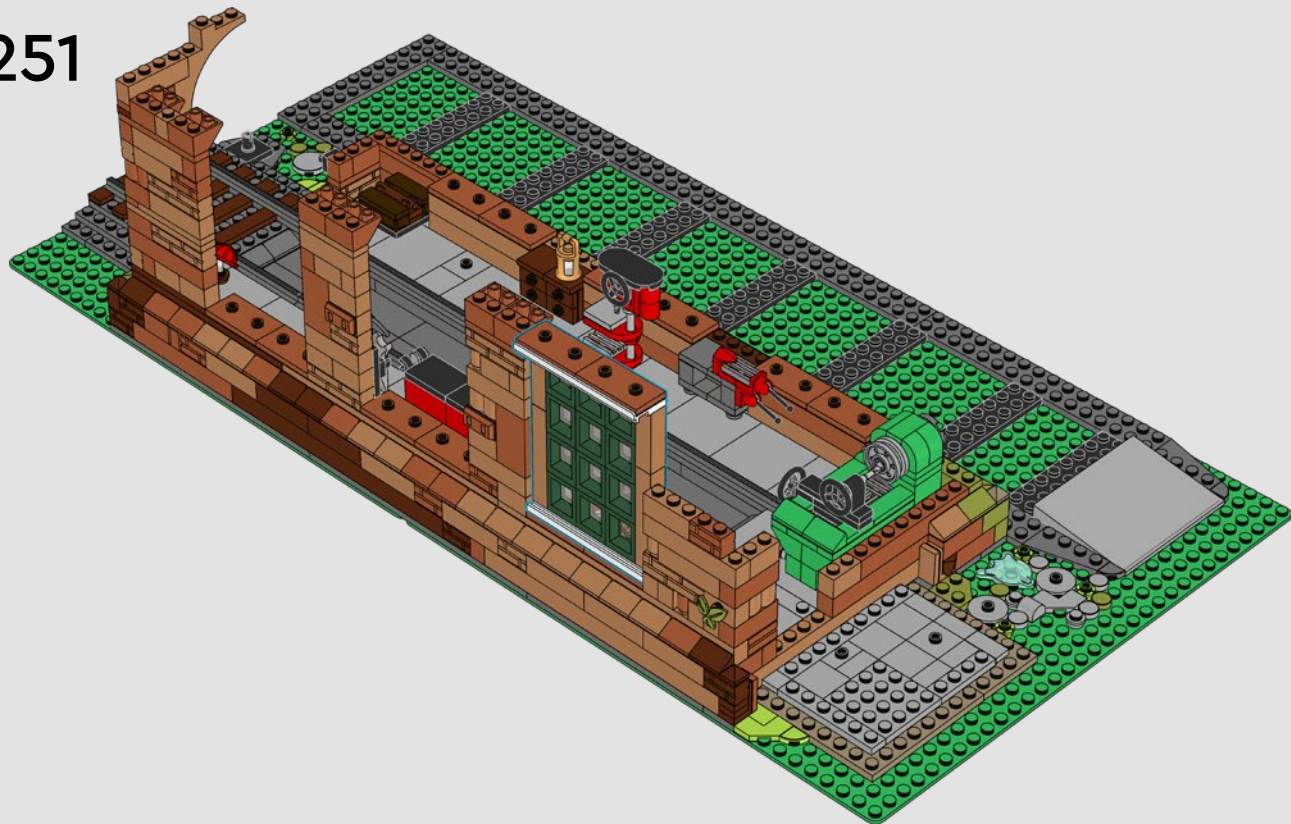

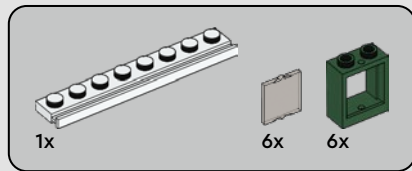
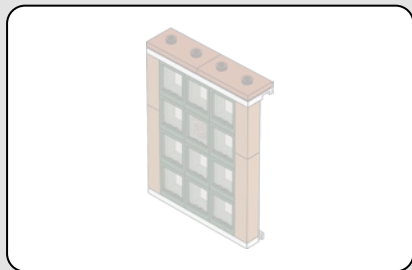

252

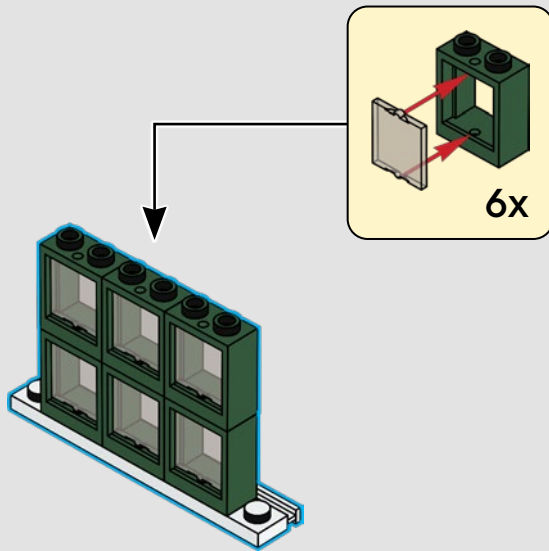

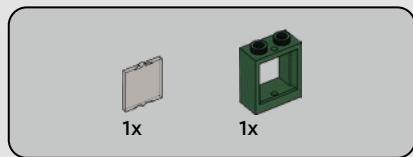

253

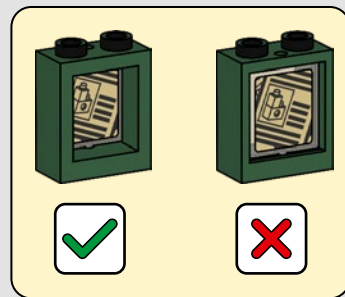
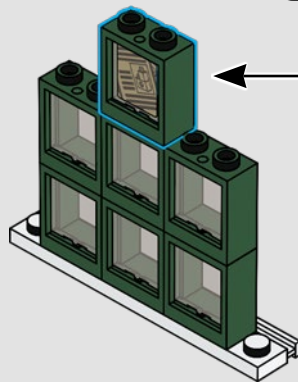
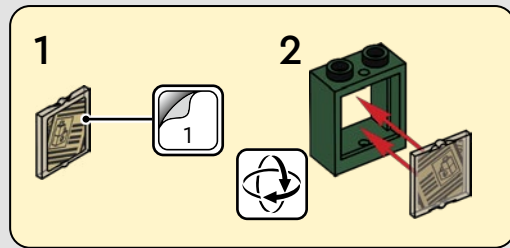

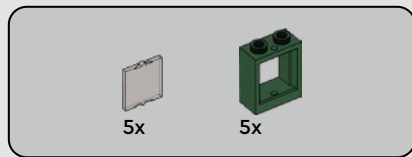

254

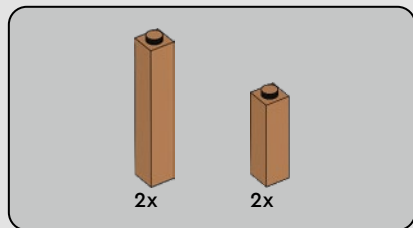
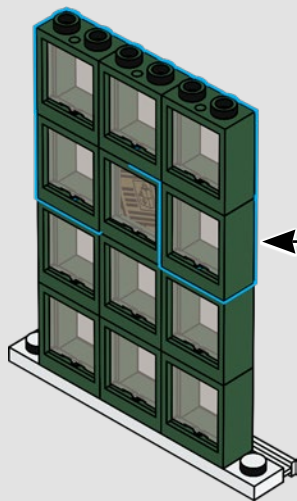
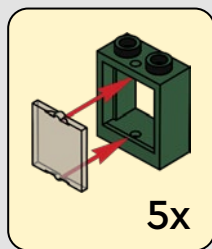

255

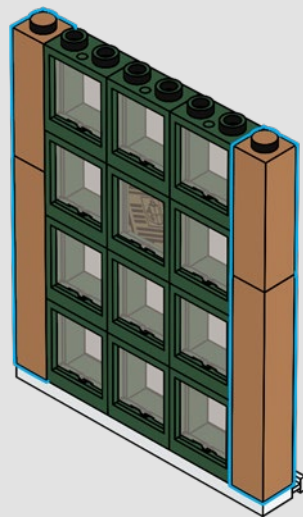

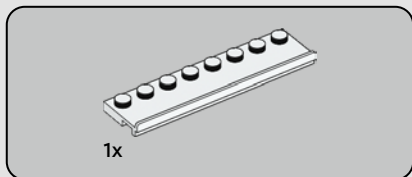

256

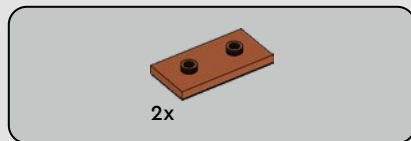
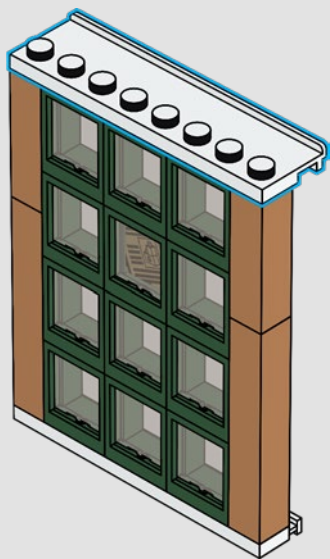

257

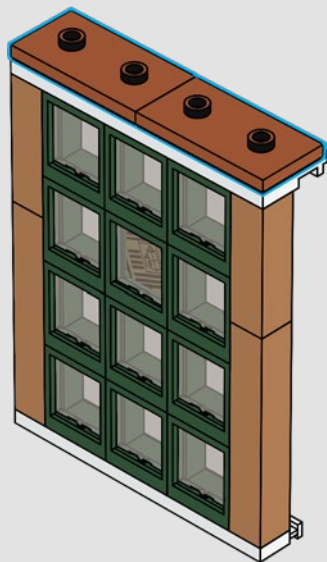

258

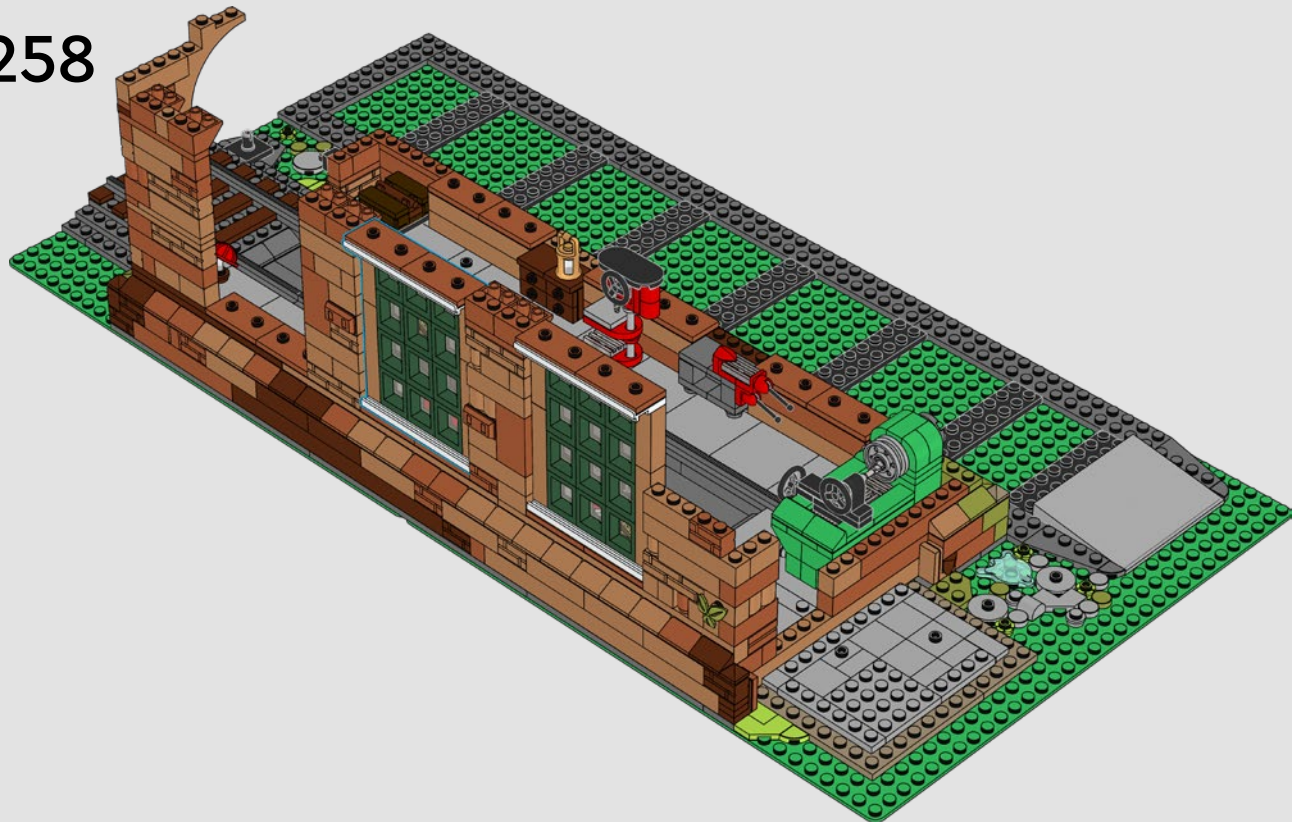

218

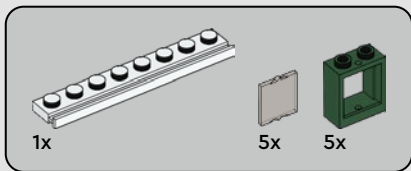
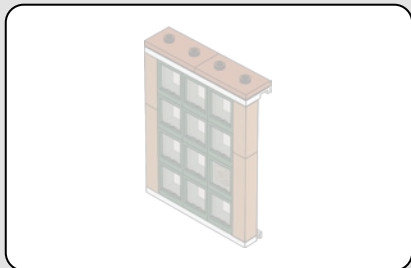

259

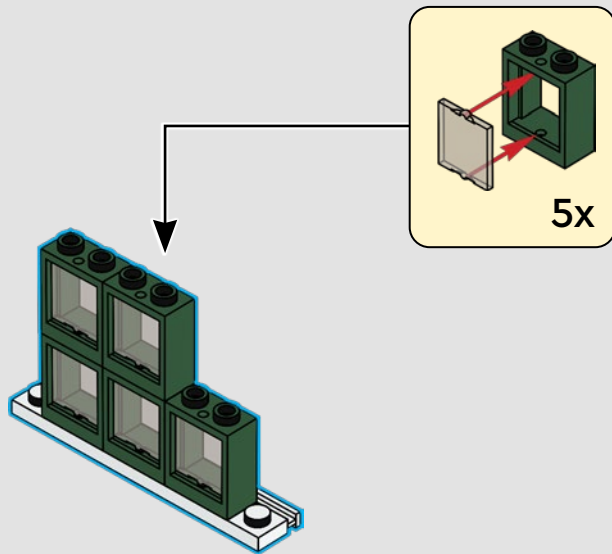

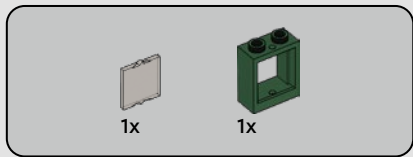

260

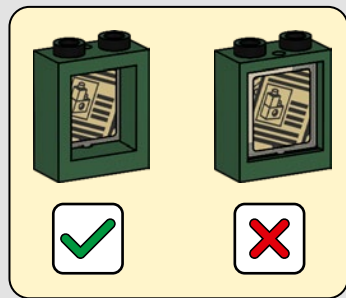
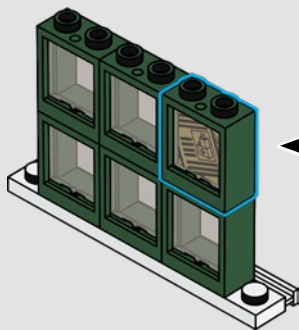
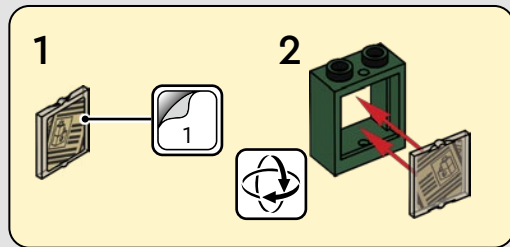

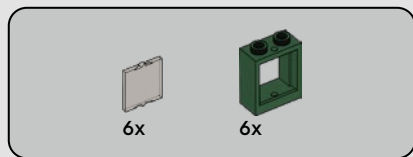

261

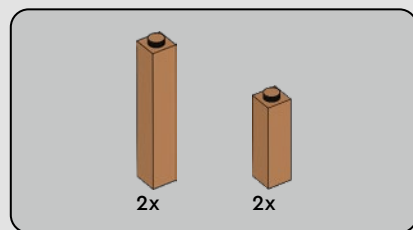
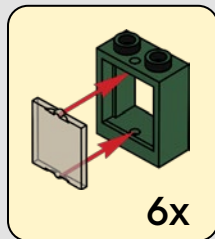
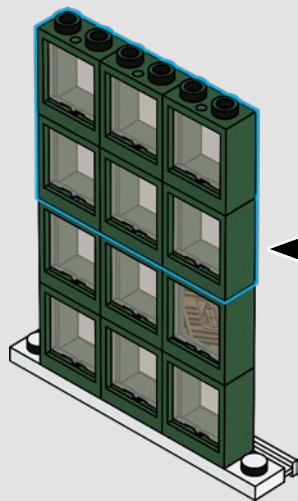

262

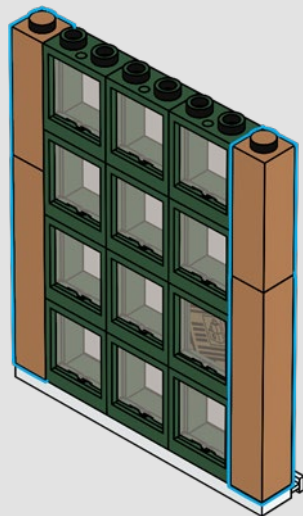

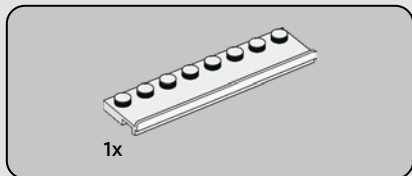

263

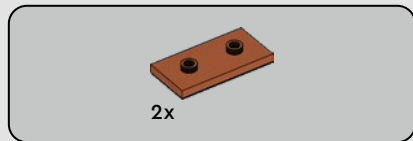
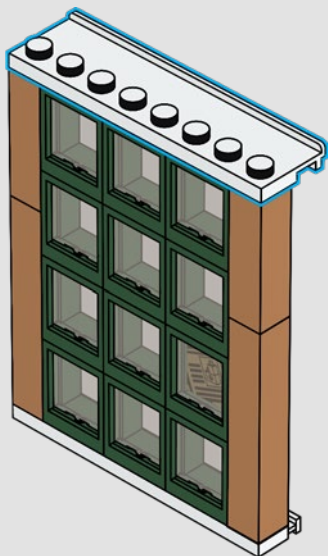

264



265





1x



1x

266

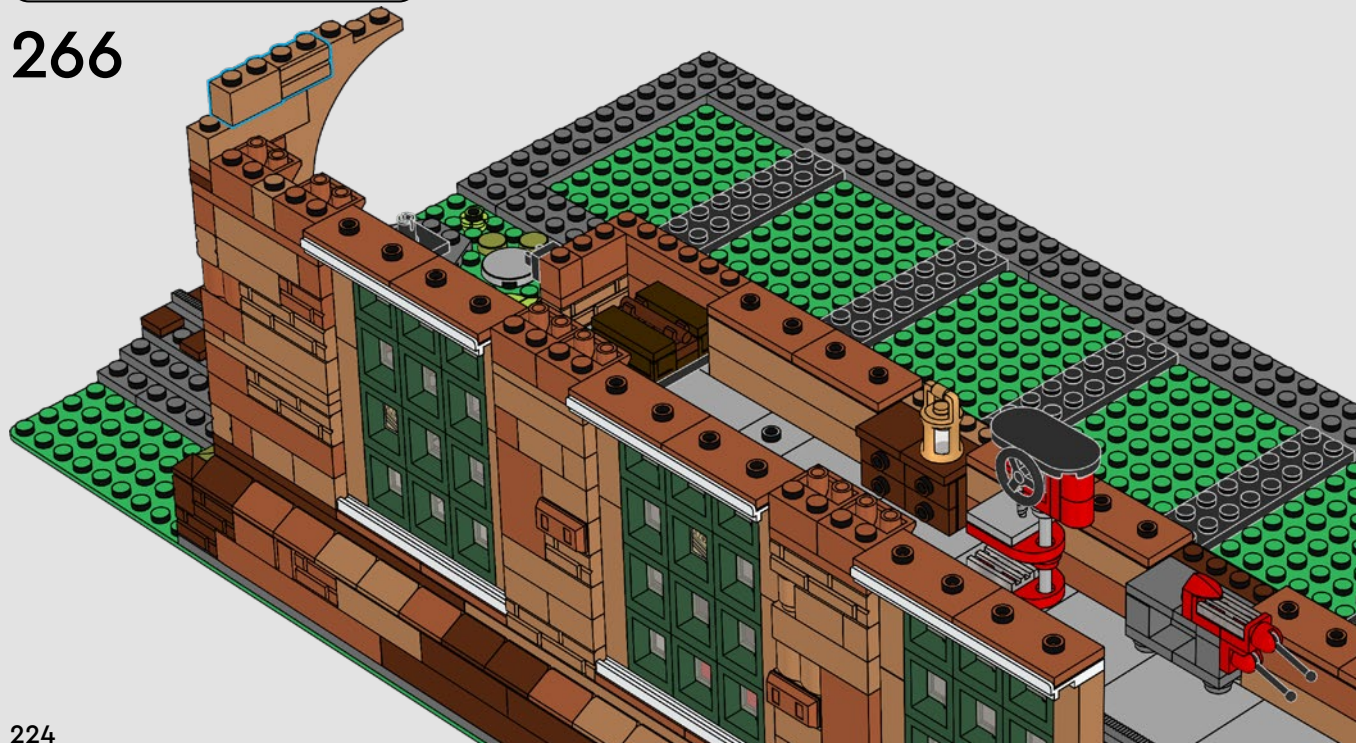

224

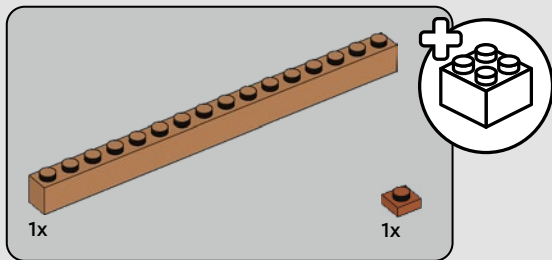

267



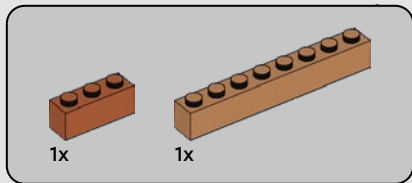

268

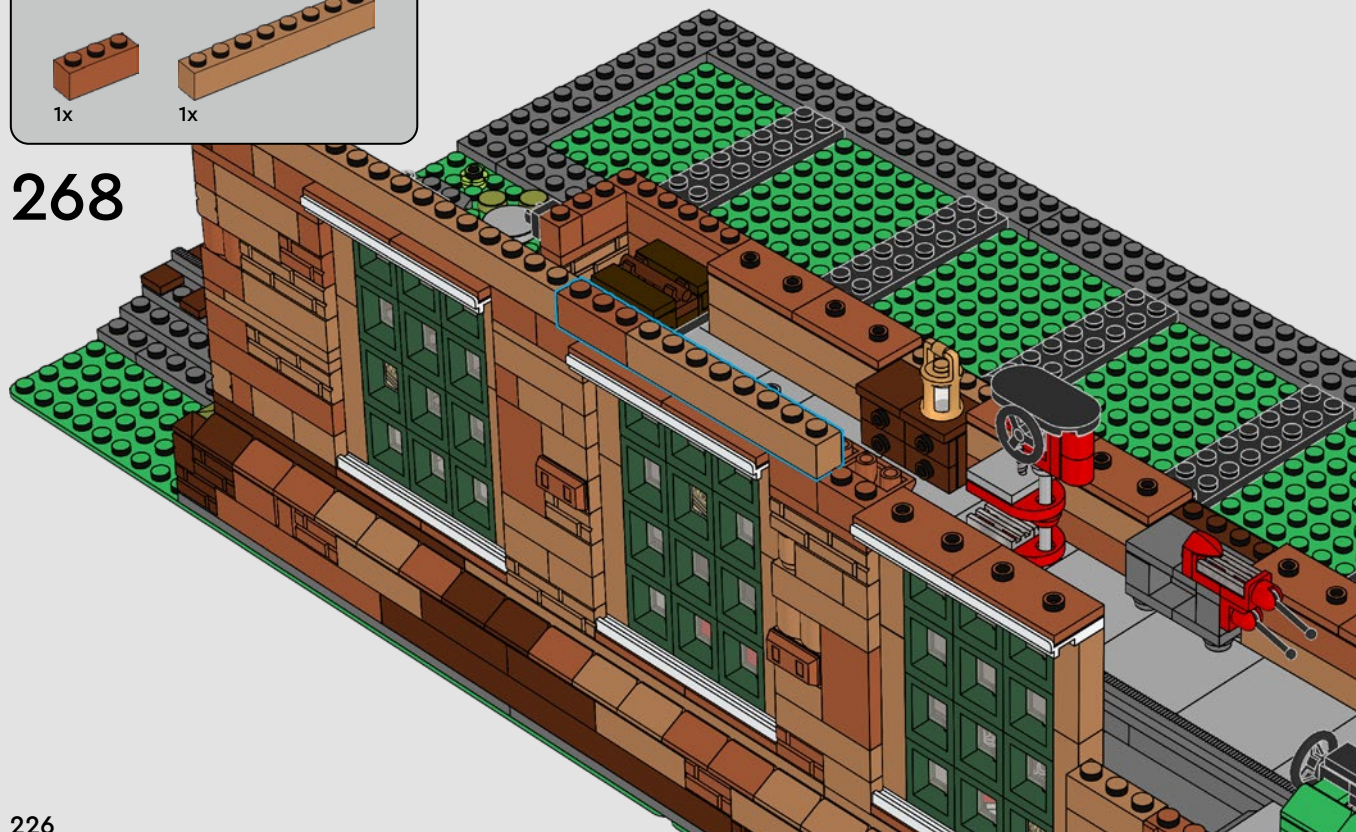

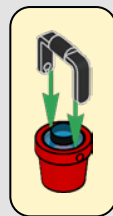
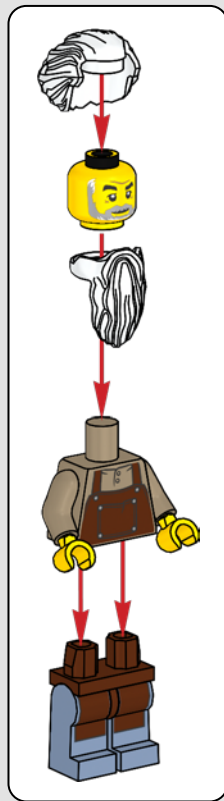

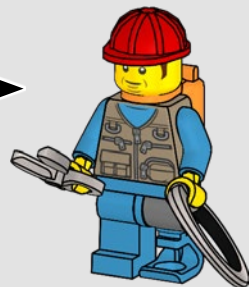
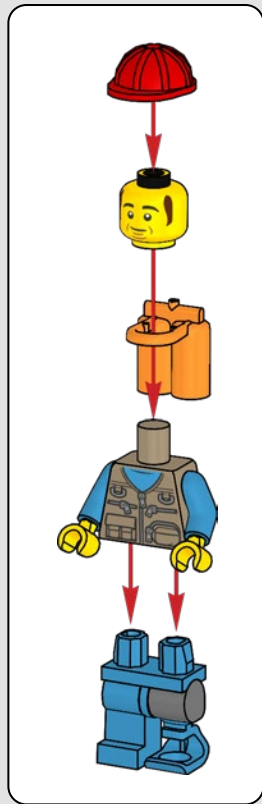
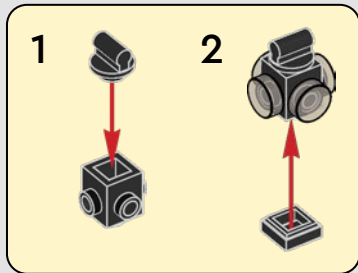
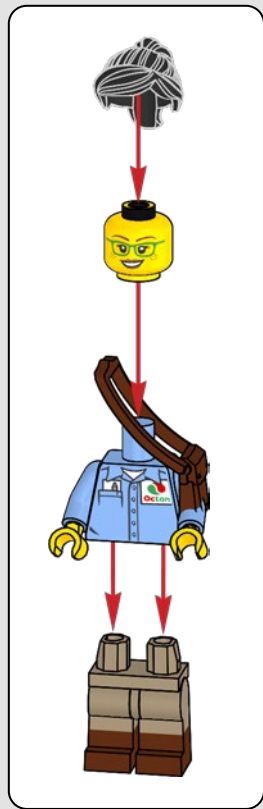

269

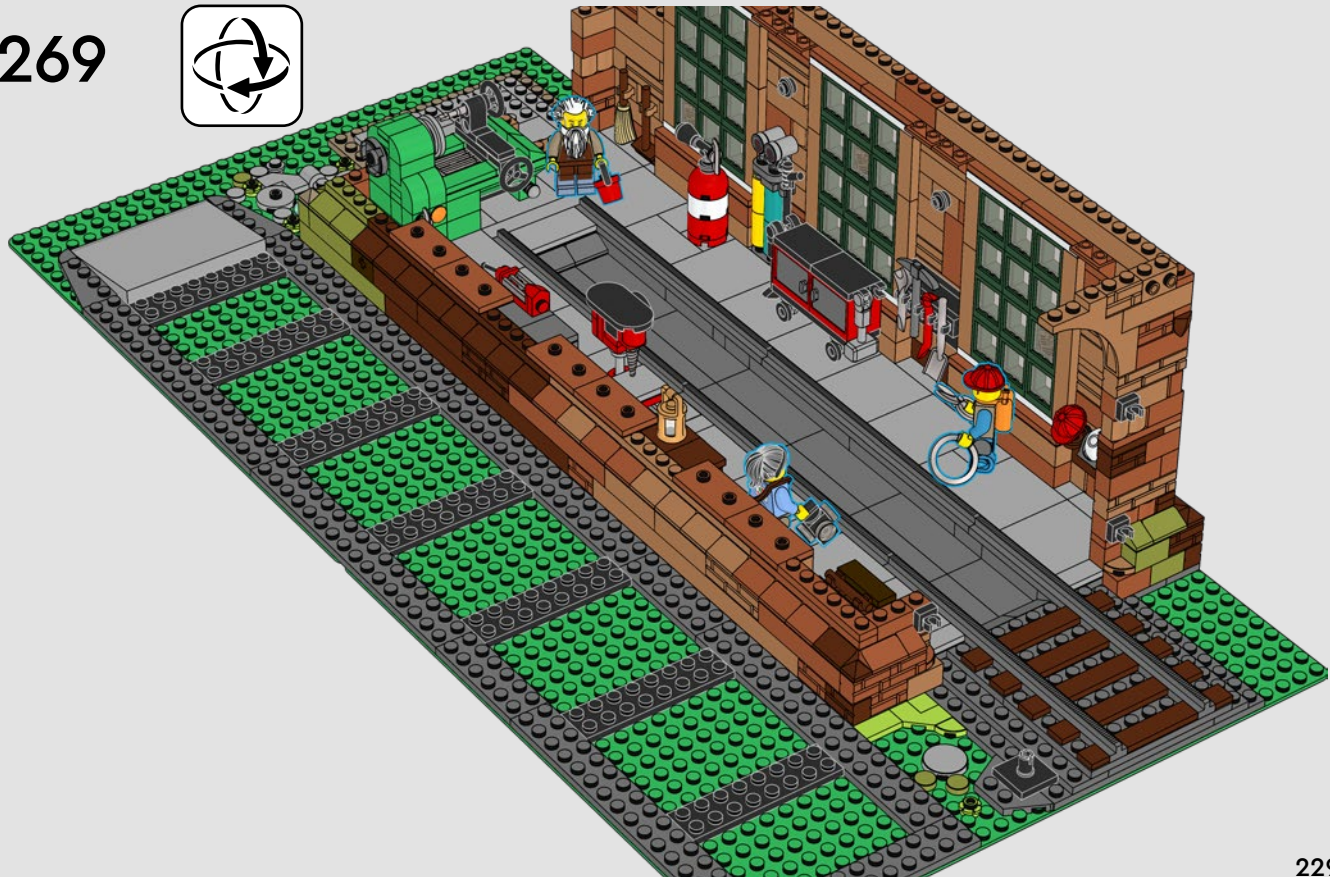

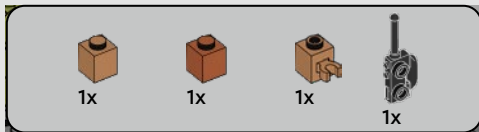

270

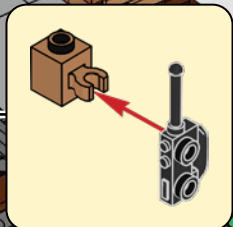
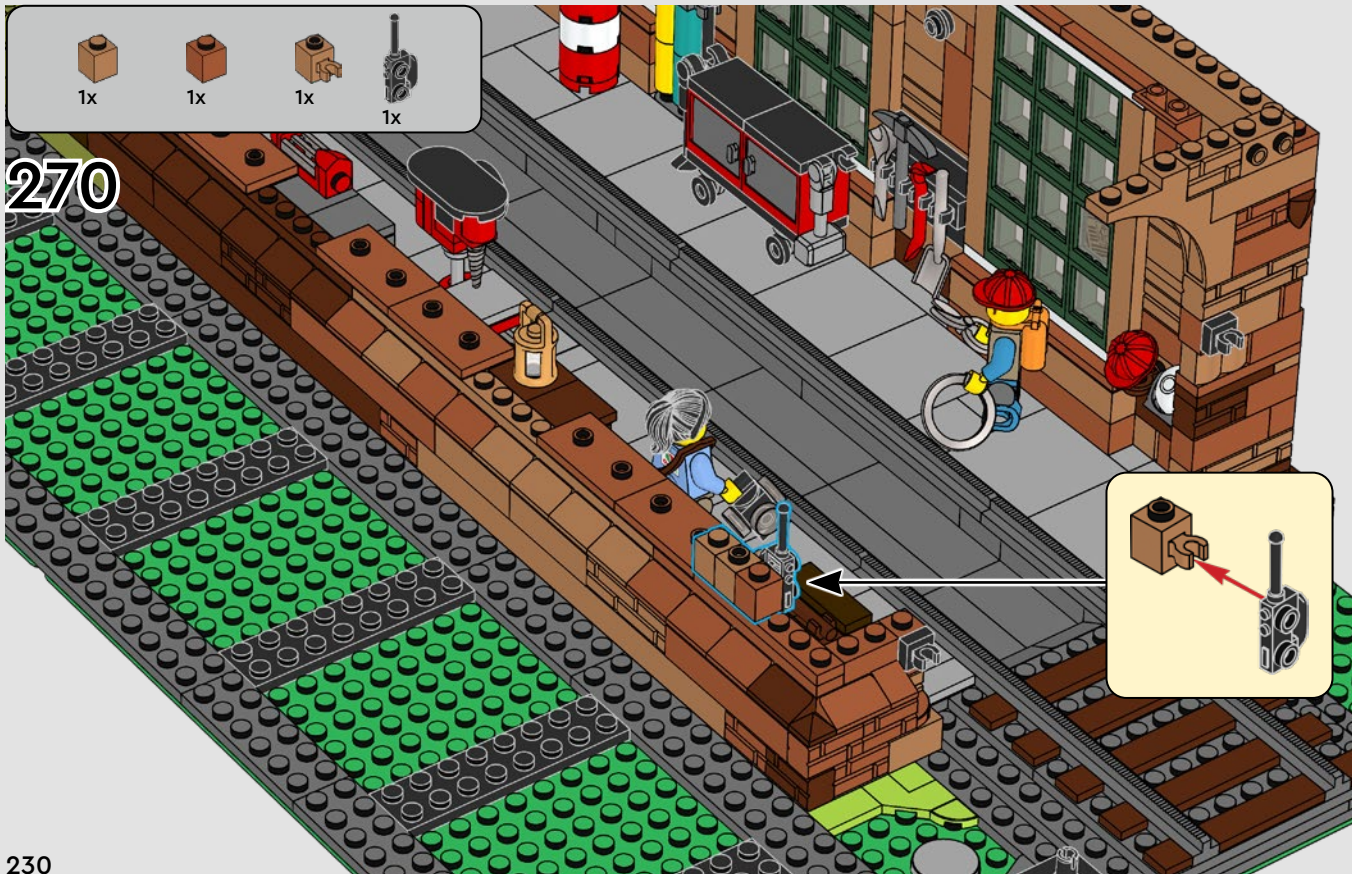

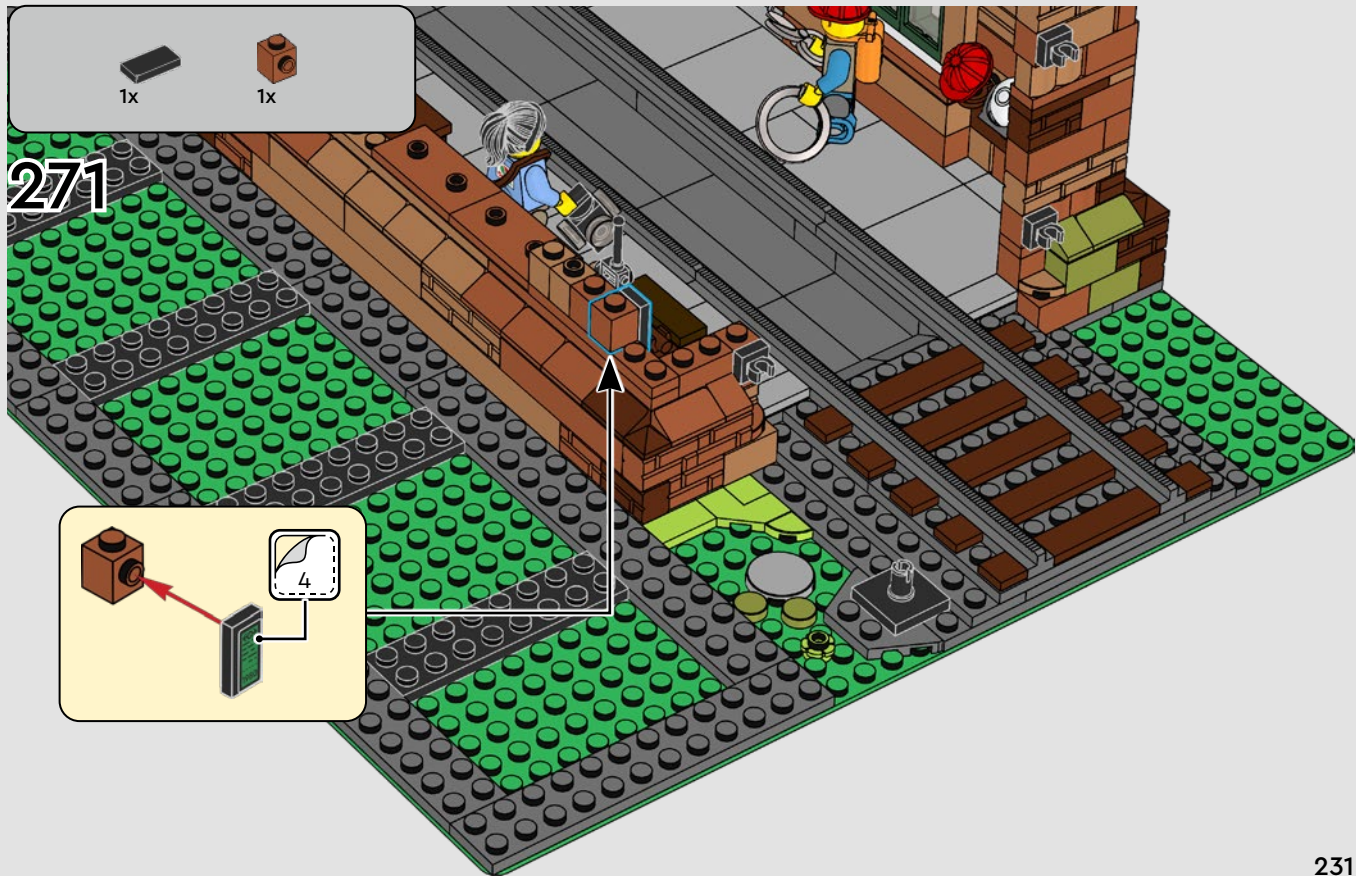

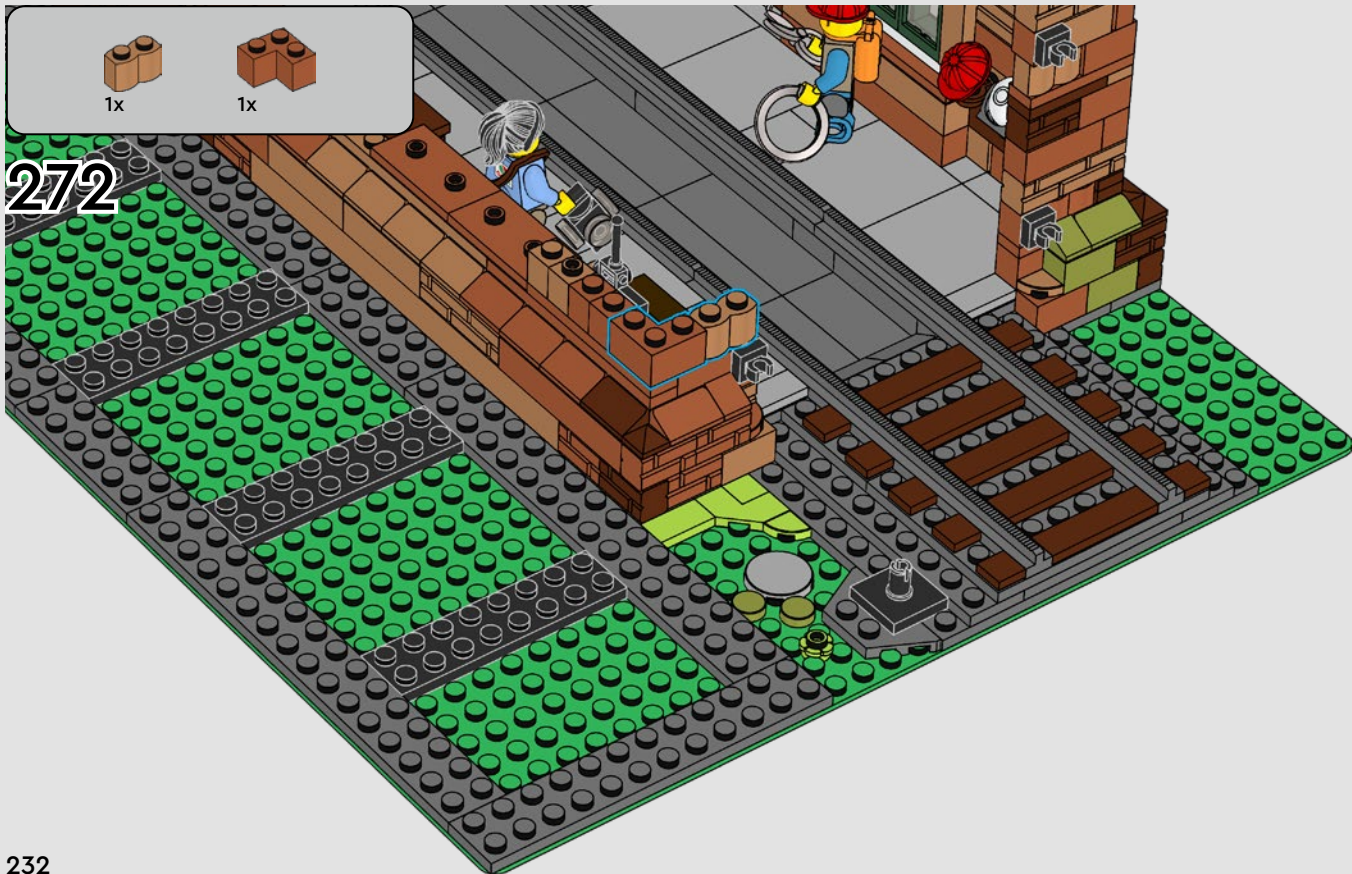



2x

1x

1x

273

1

2

3

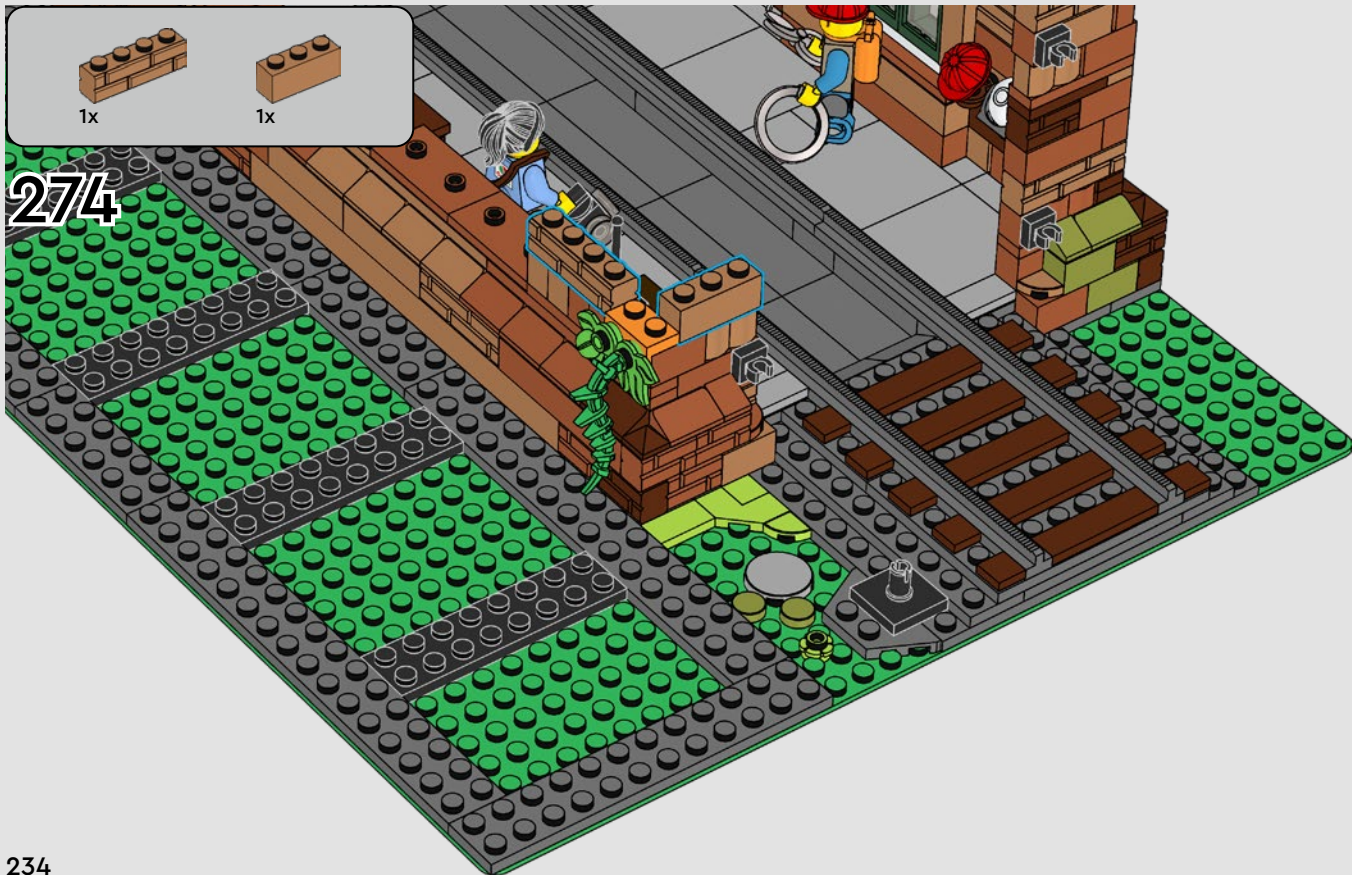

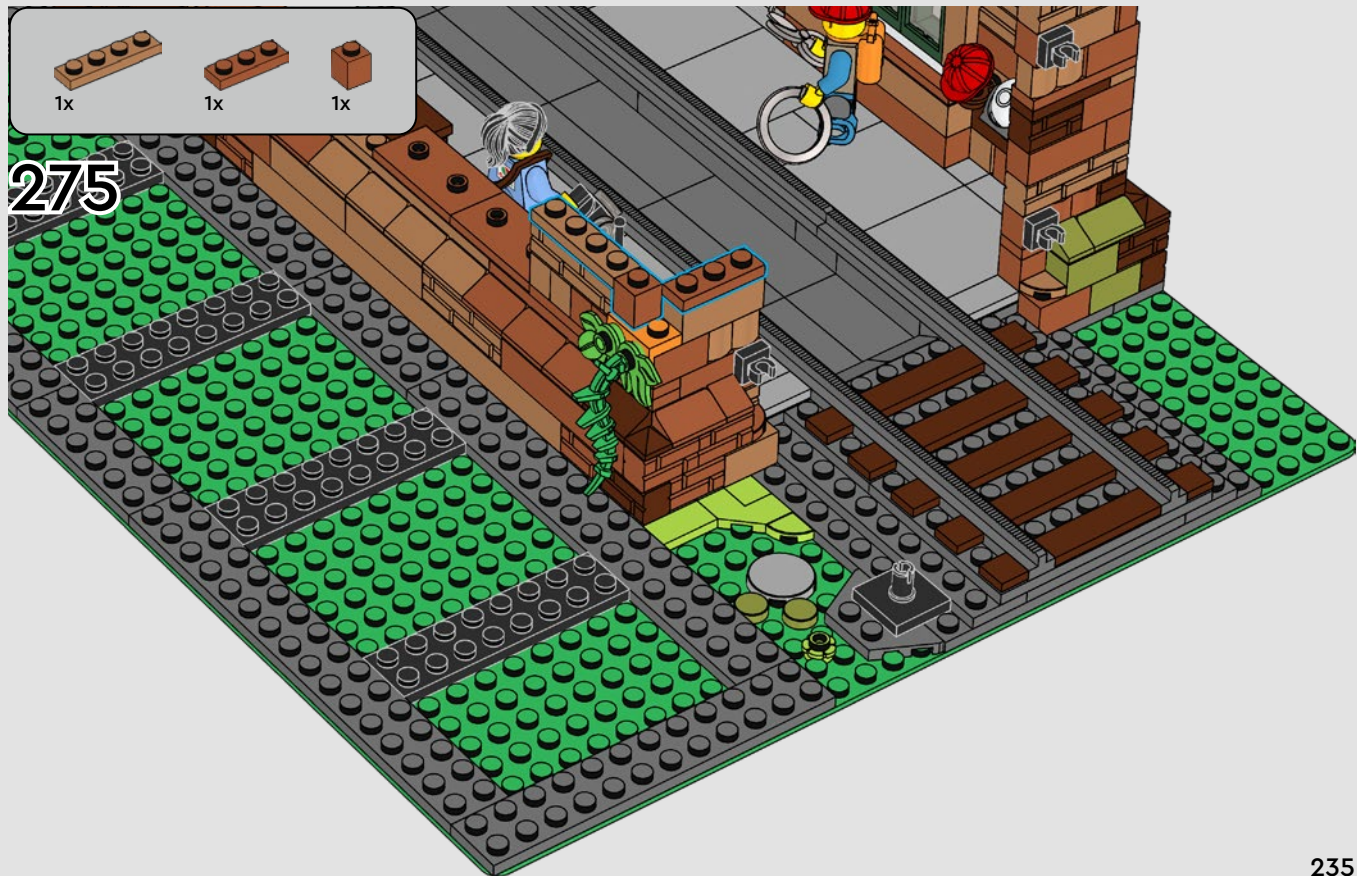

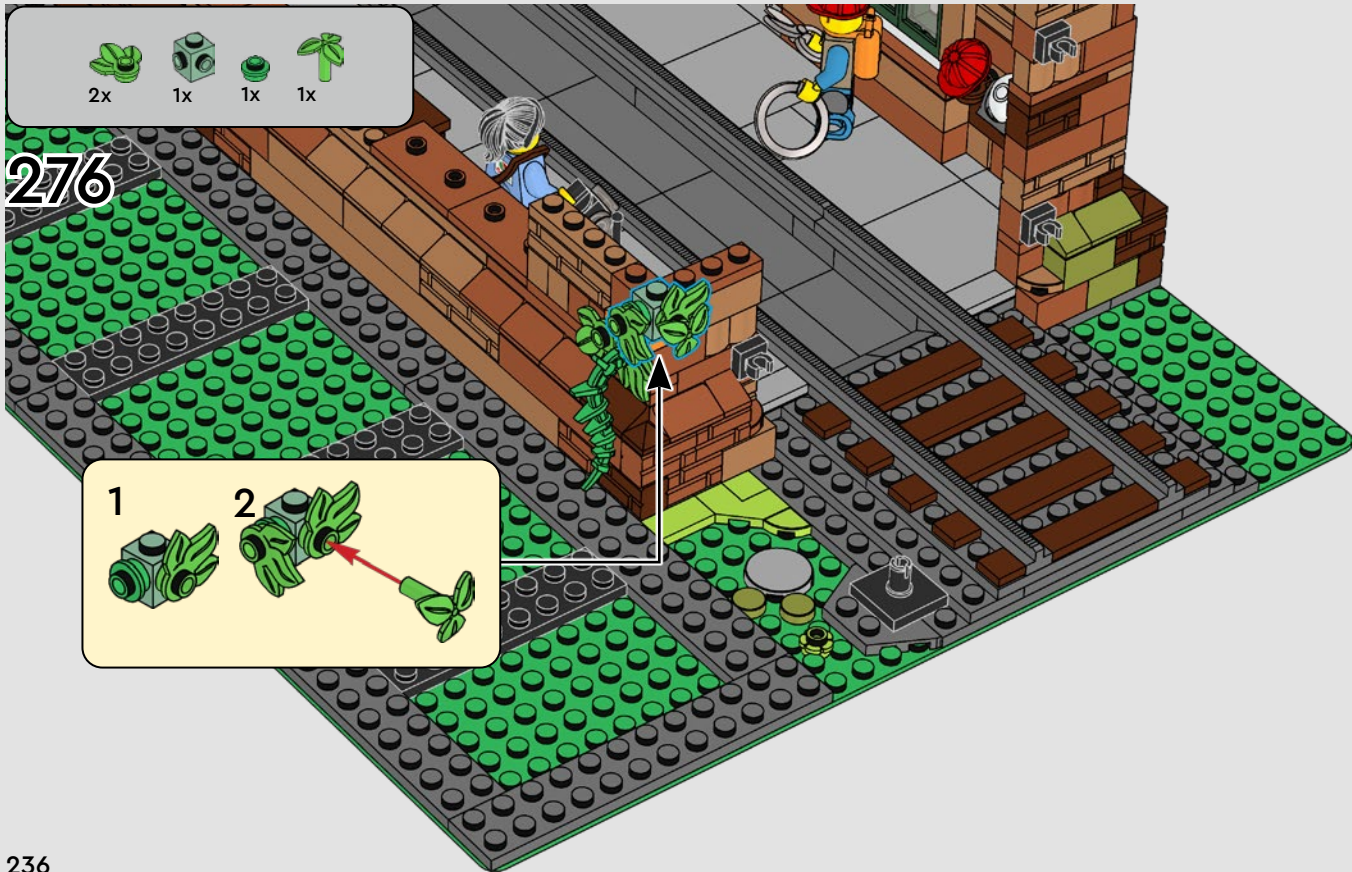

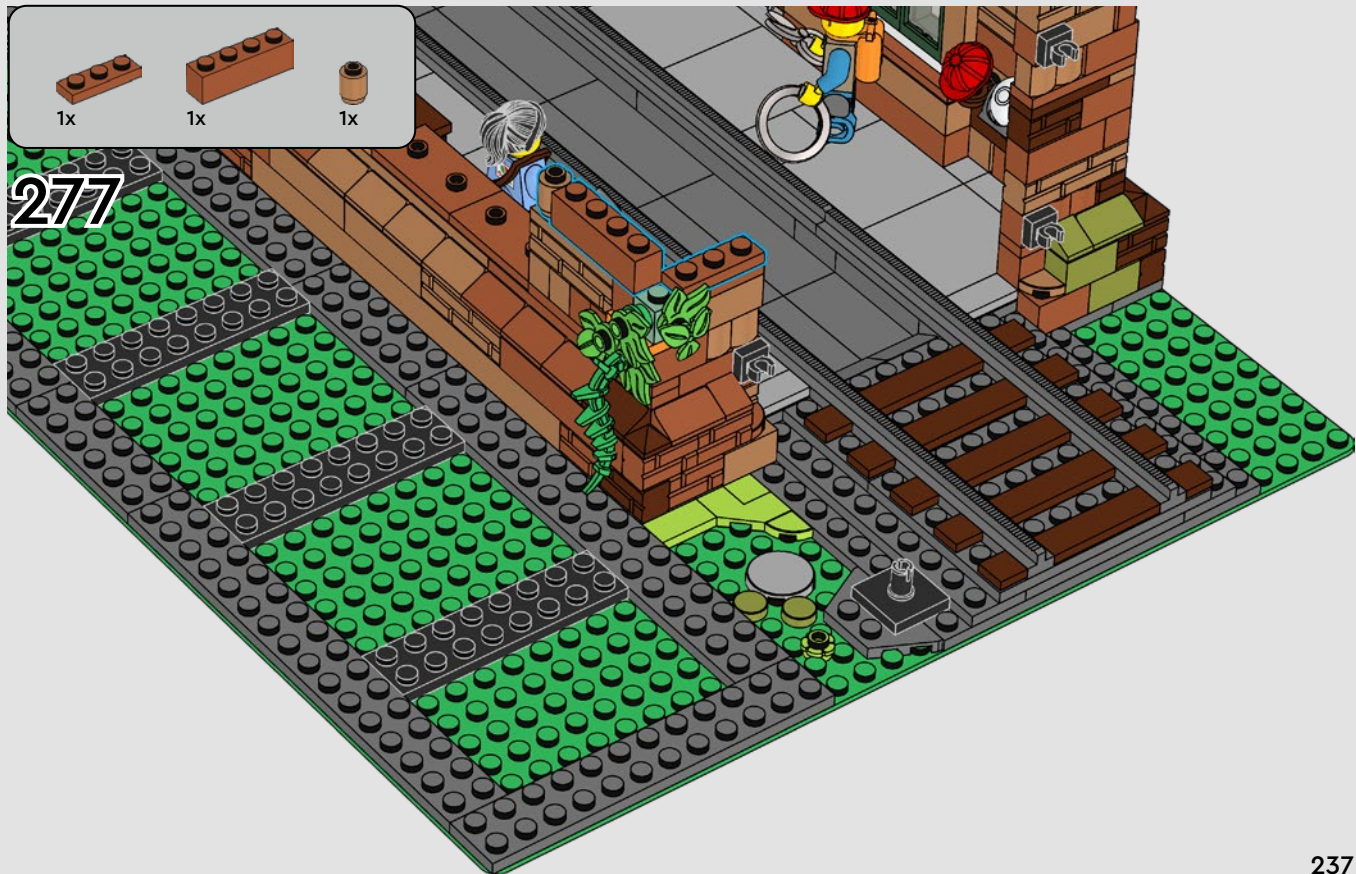

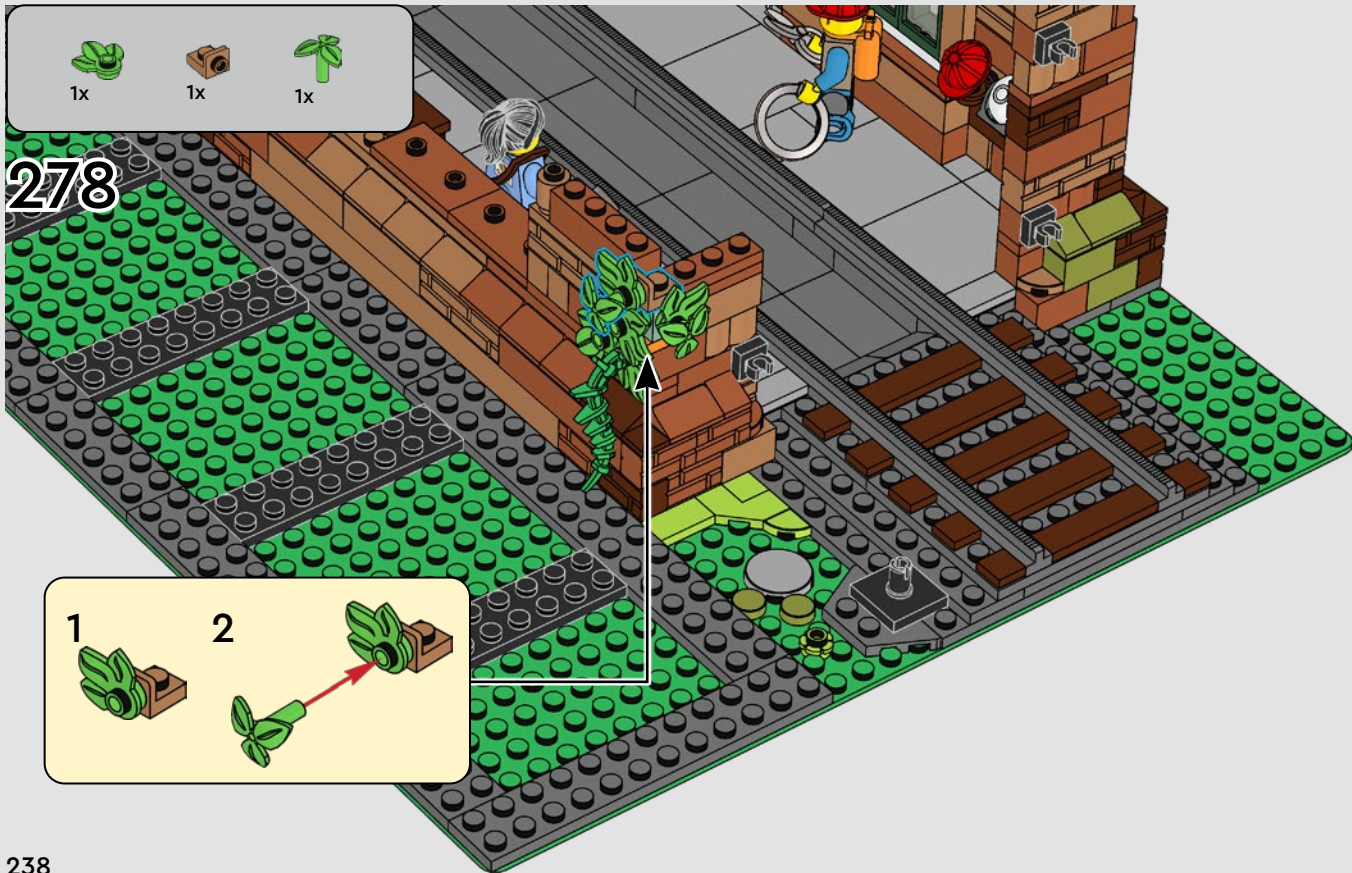





2x



1x



2x

281

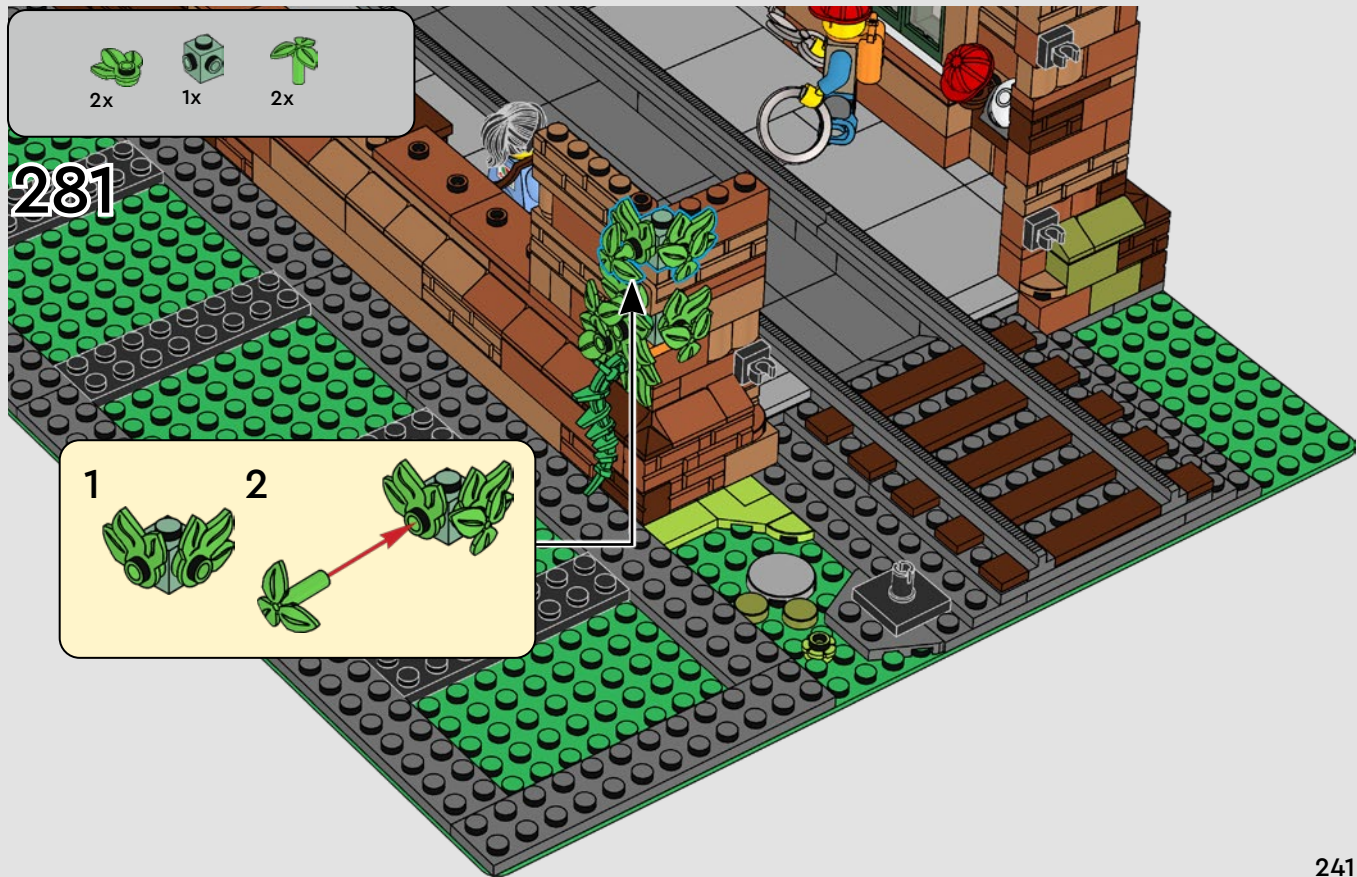
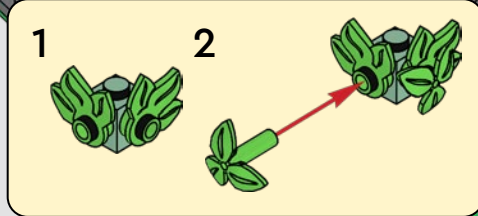



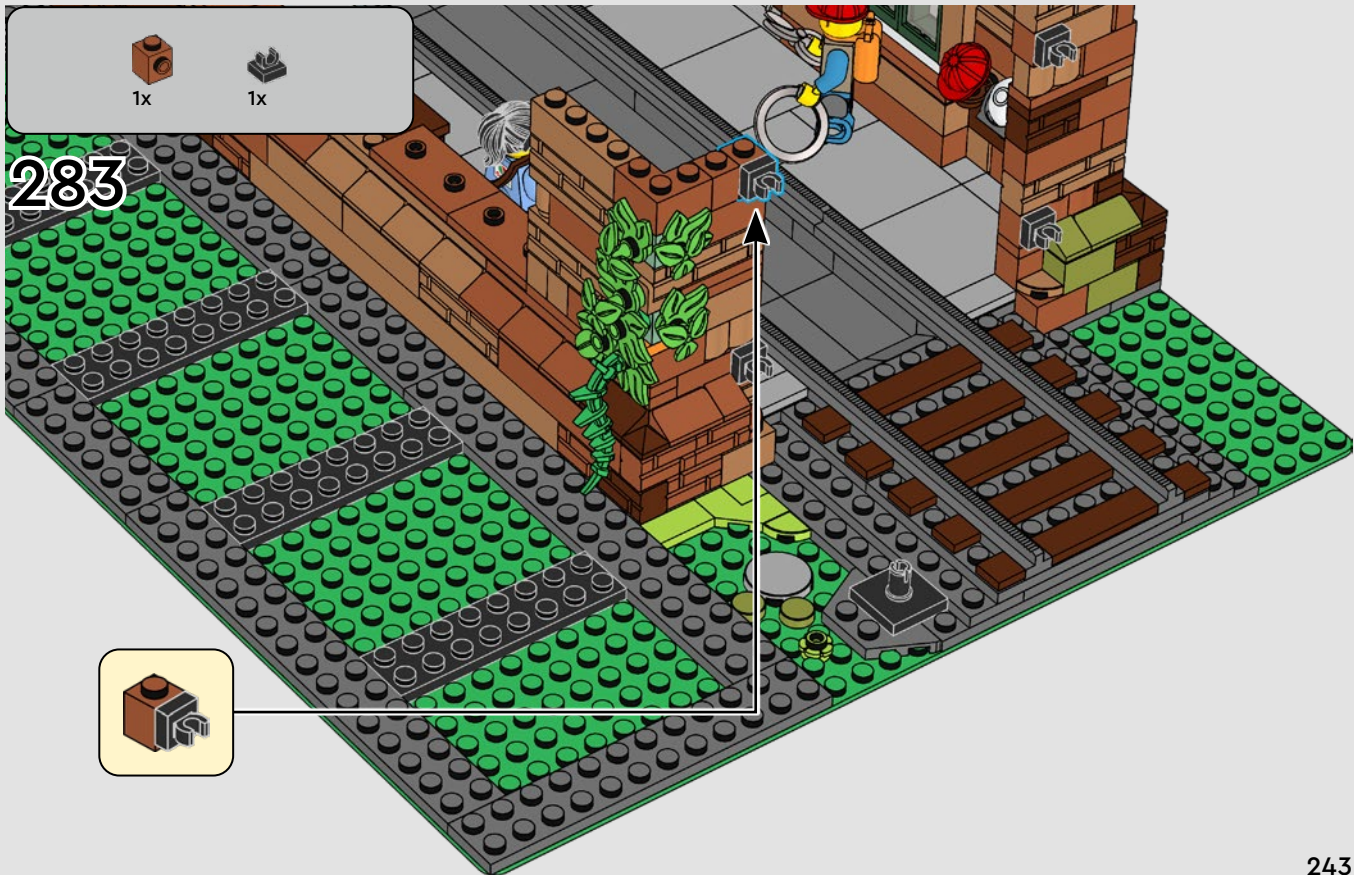

283



1x





1x







1x  2x 

287





289

1x



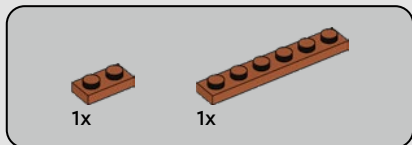
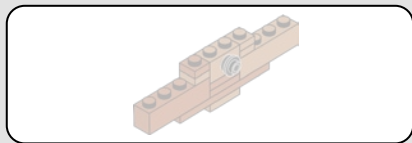

291

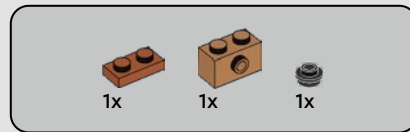
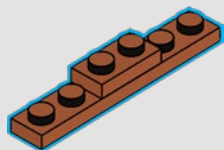

292

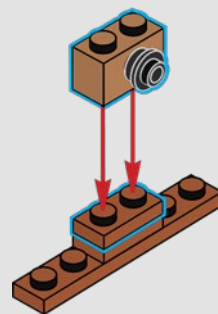

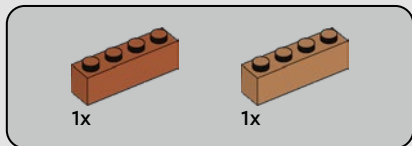

293

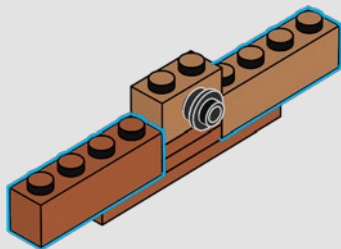

294

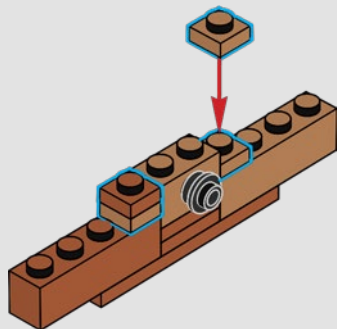

252

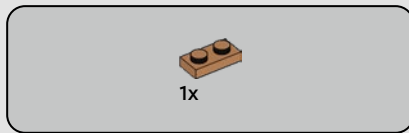

295

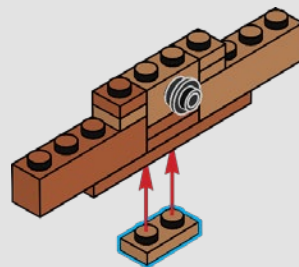

296



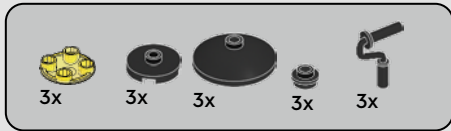

297

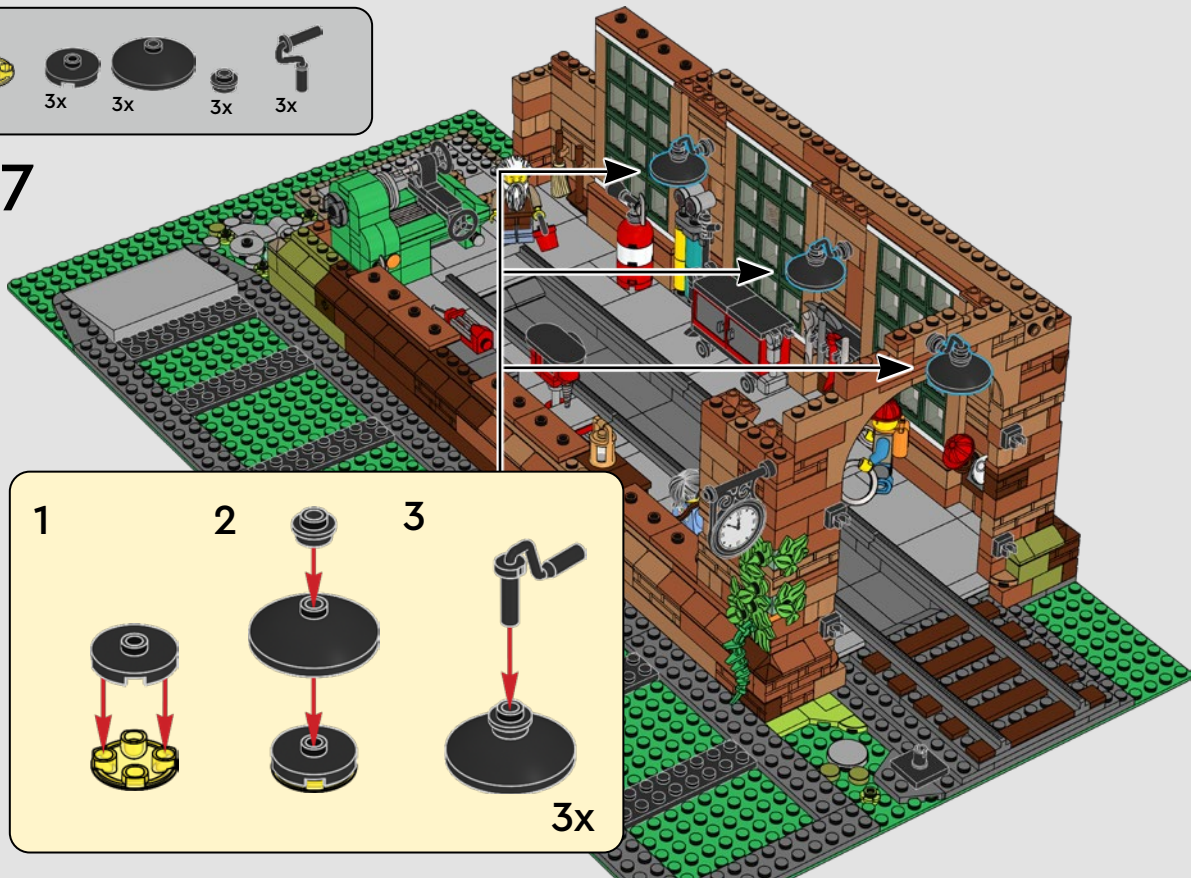



1x

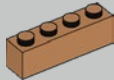

1x

298

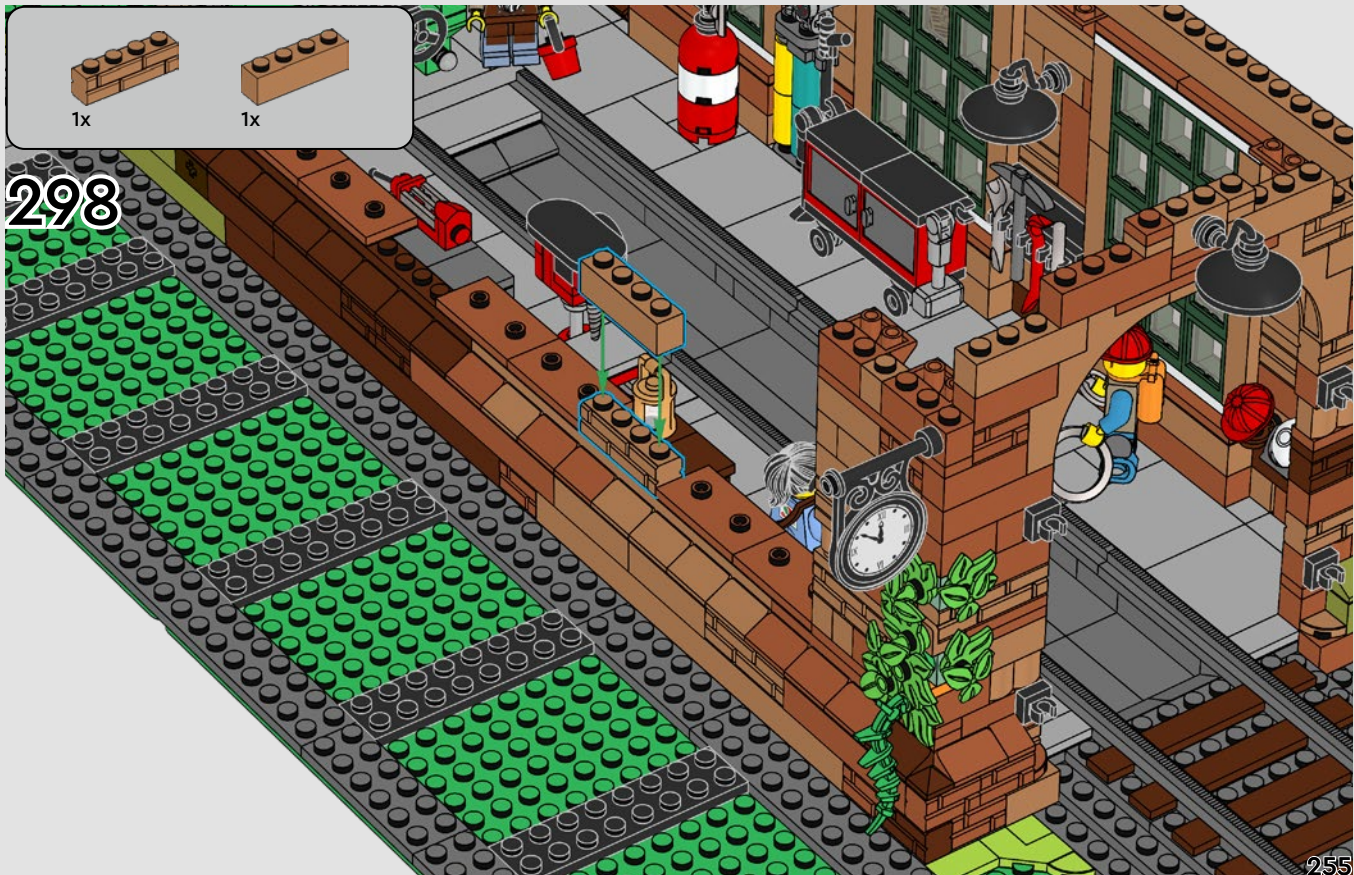



299

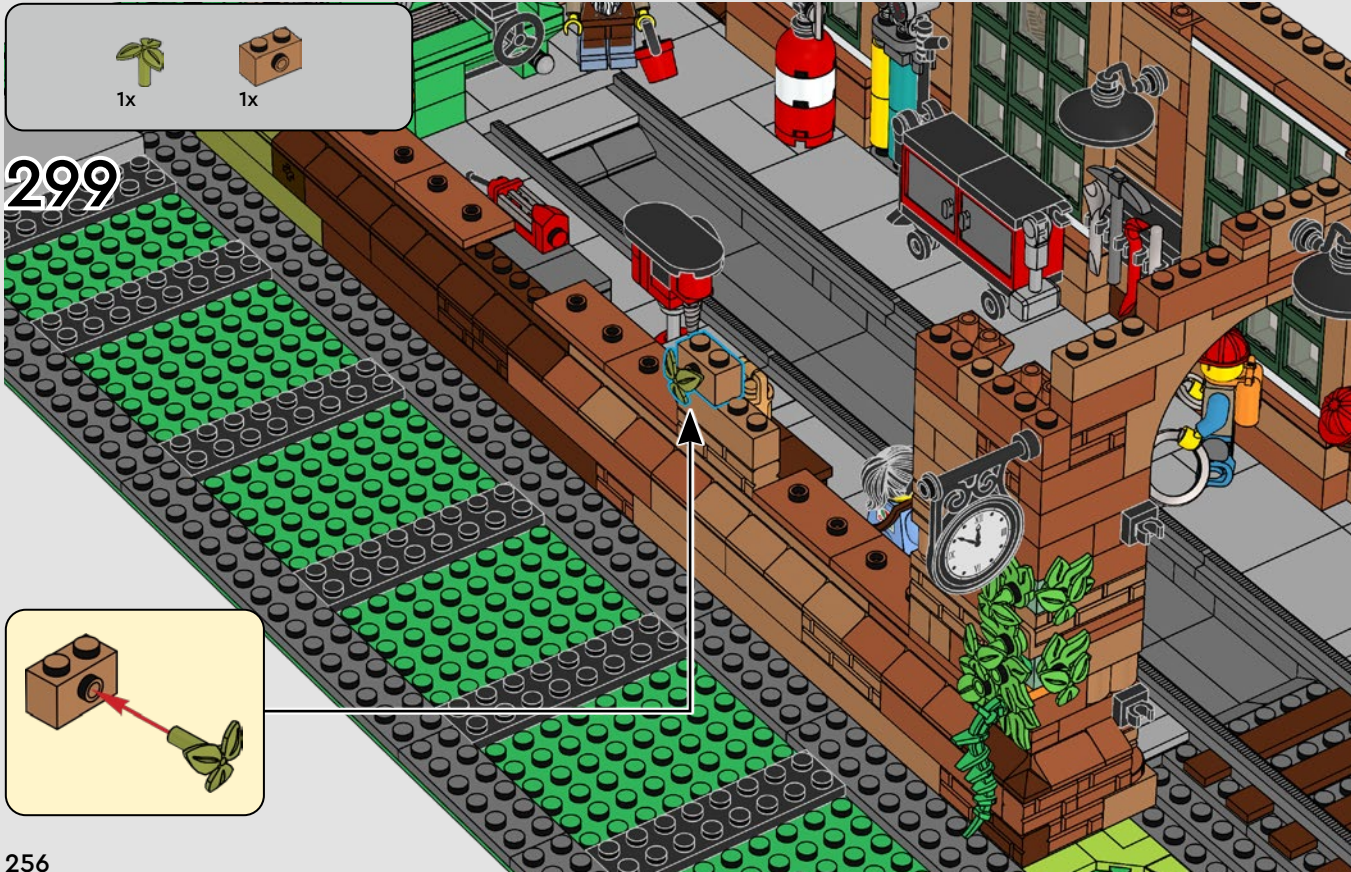
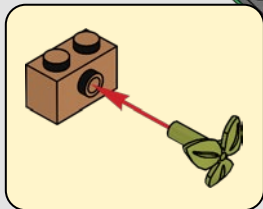

1x



1x



300

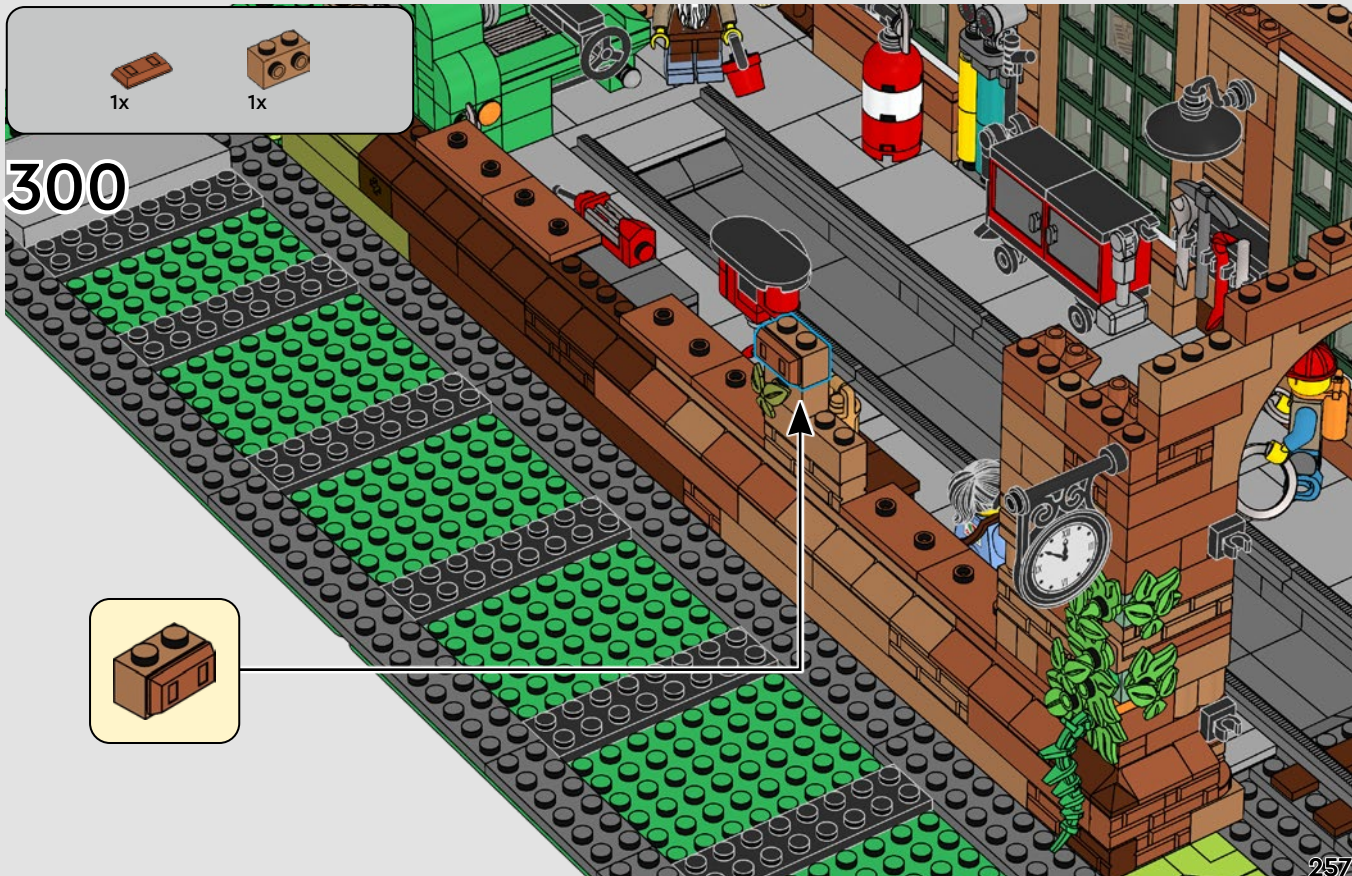

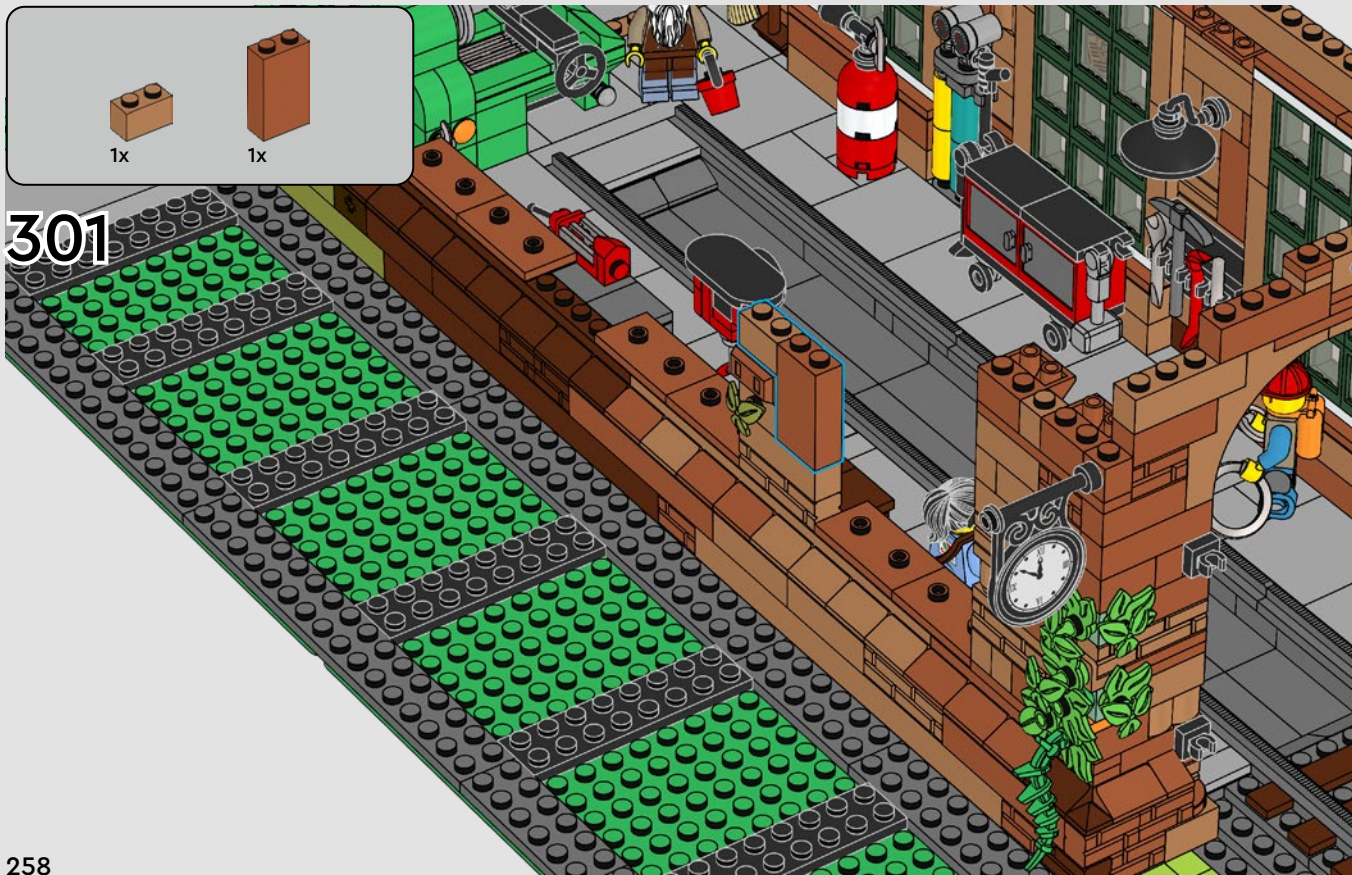

2x

1x

302

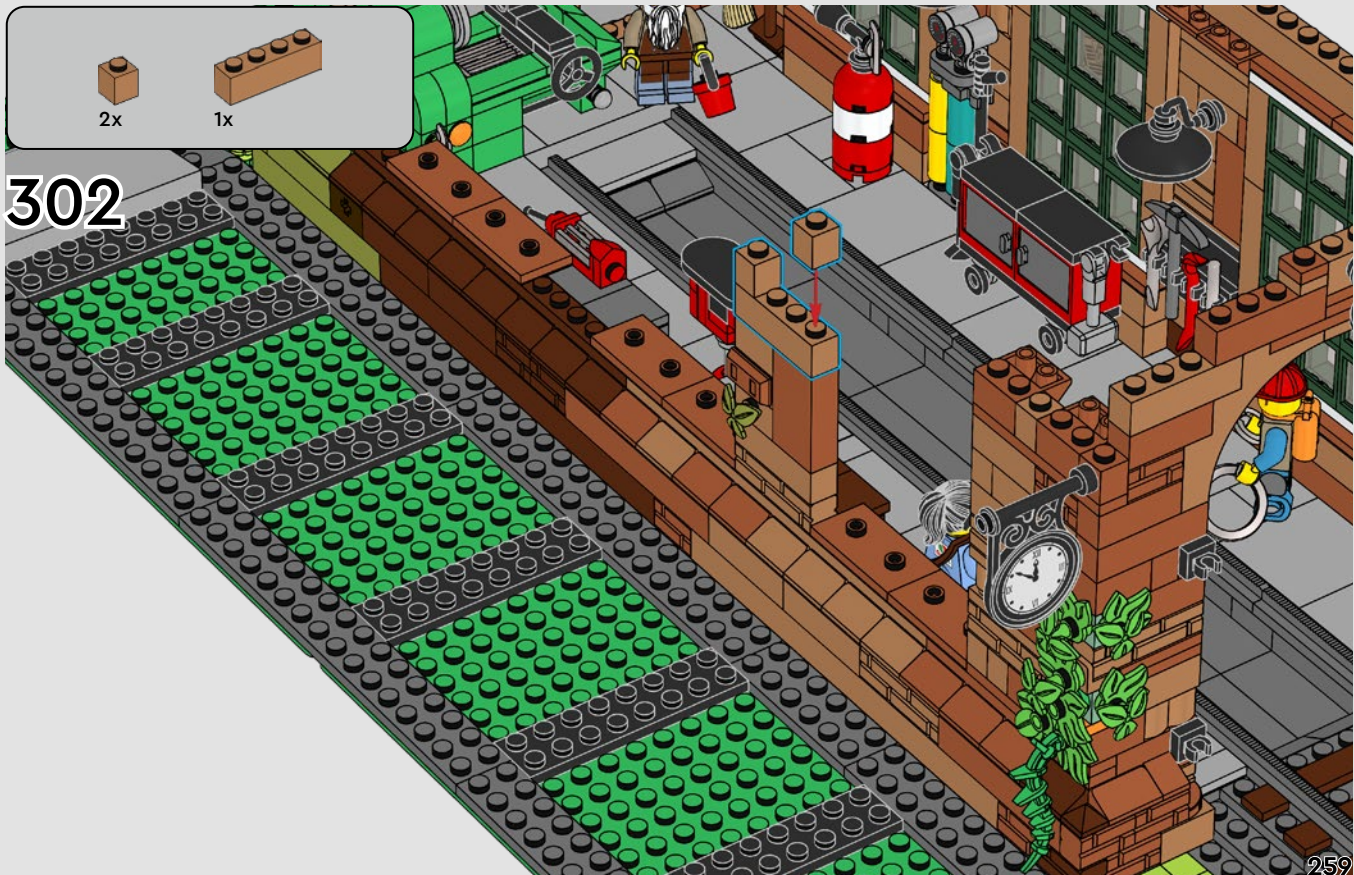

1x

1x

303

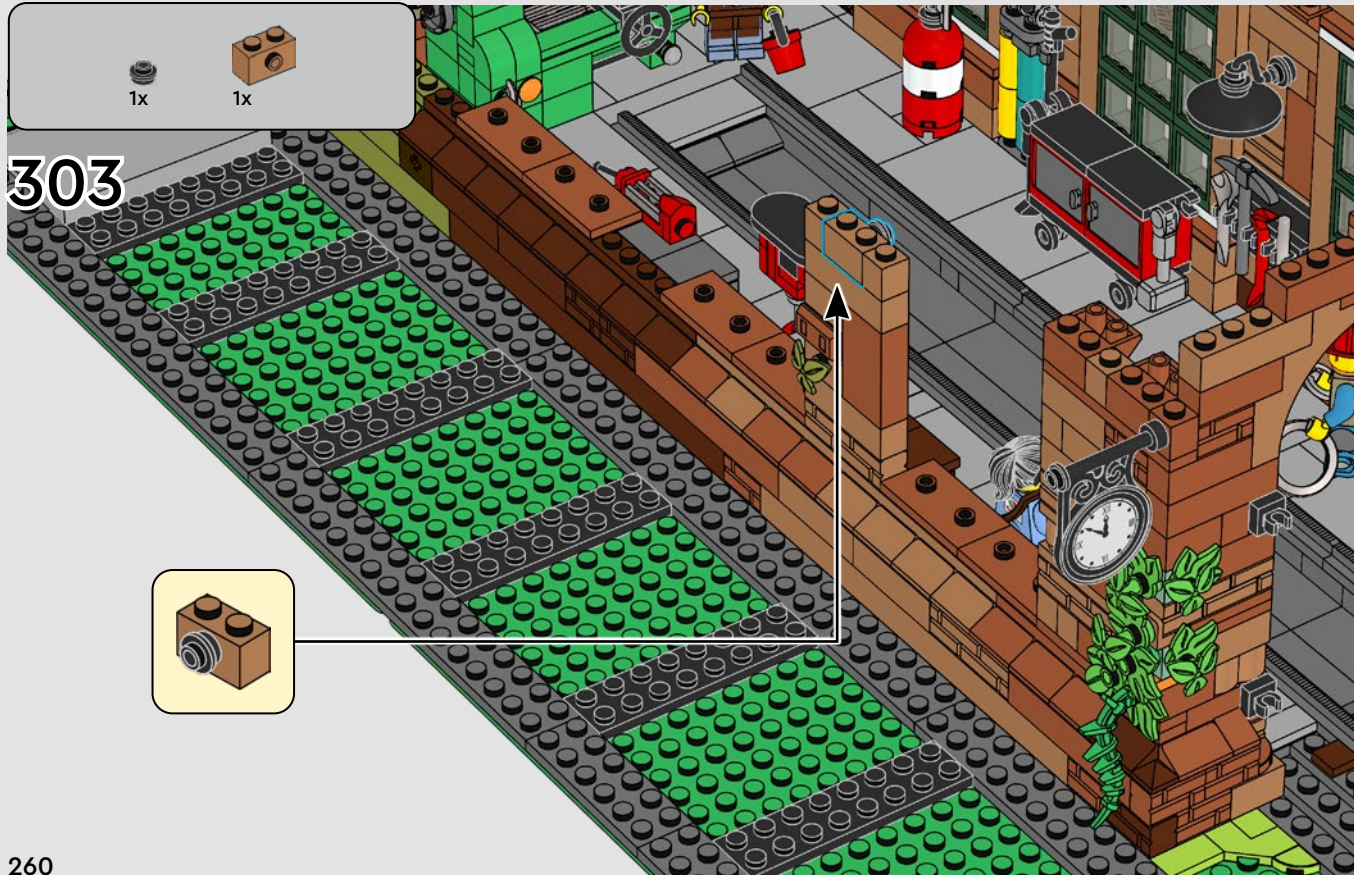



2x

304

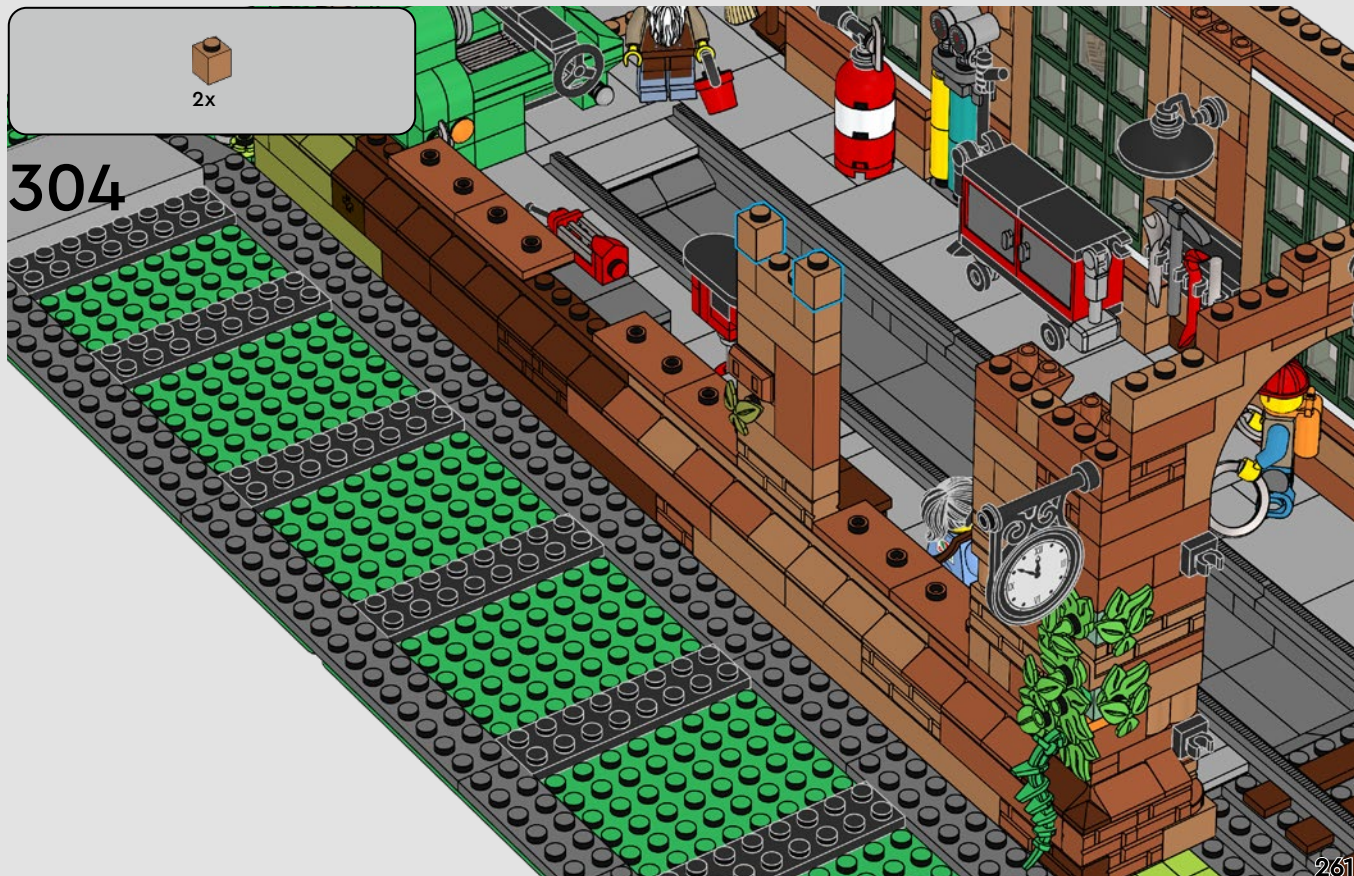

1x

1x

305

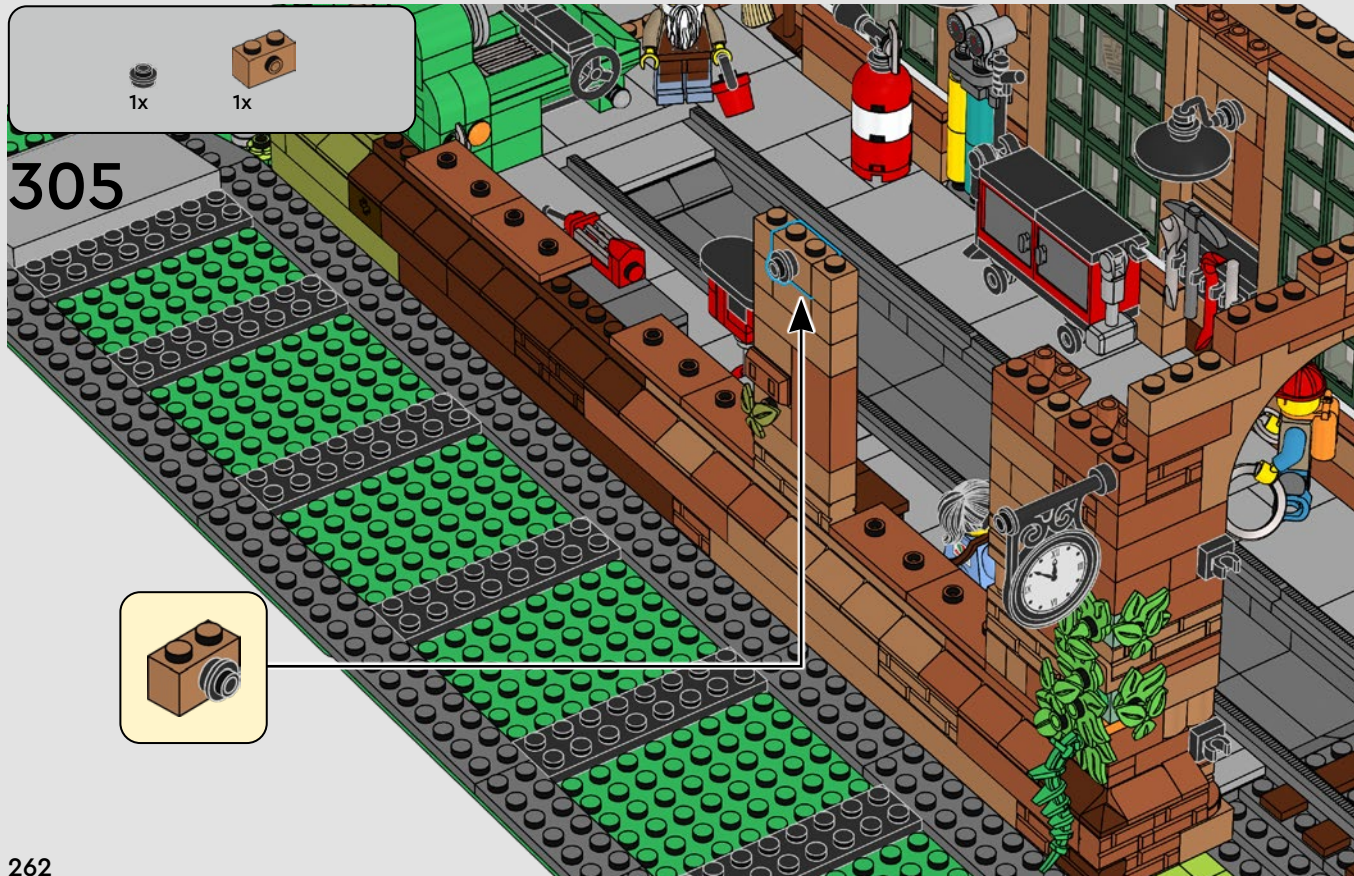

1x



2x



306

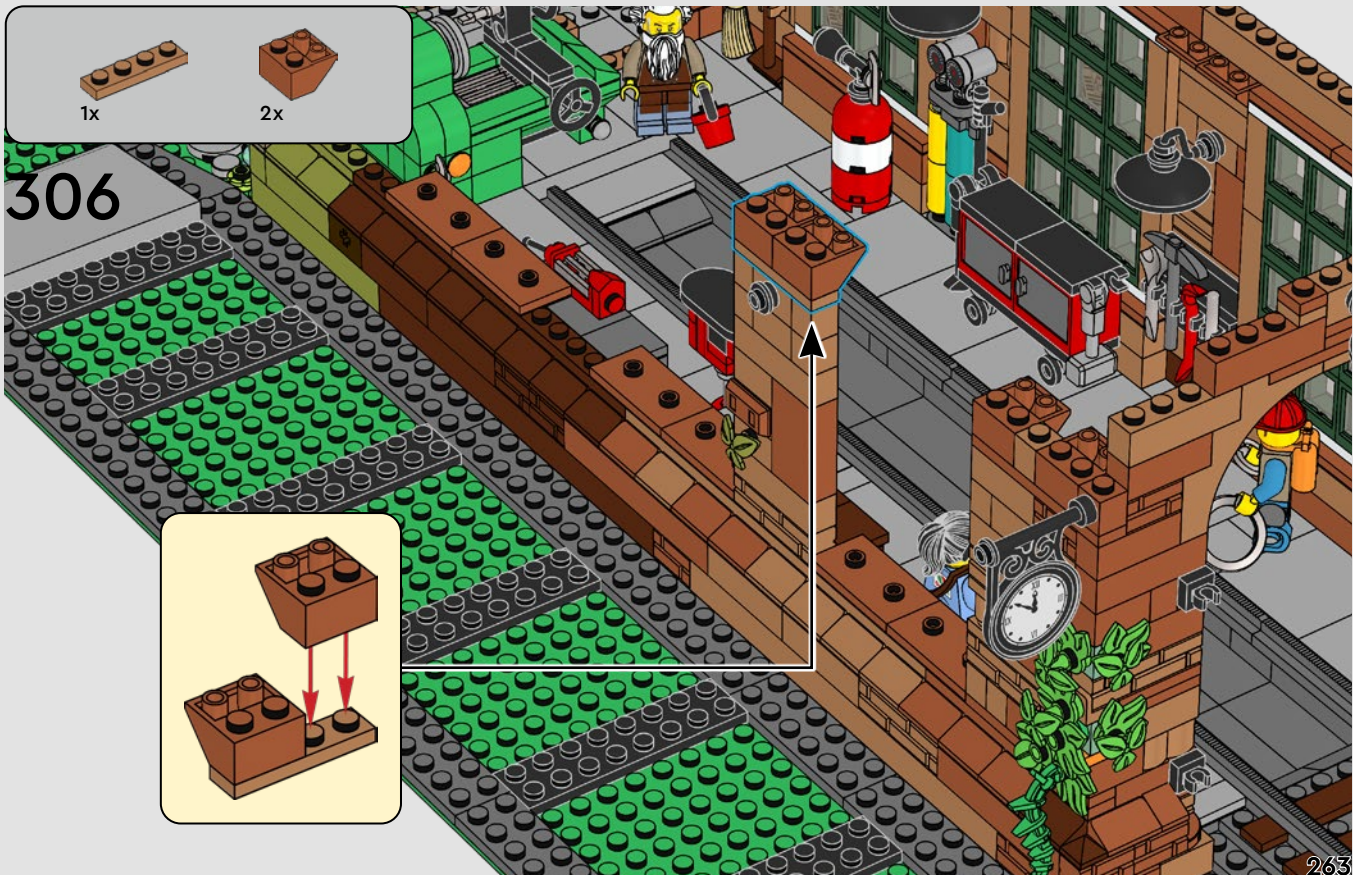
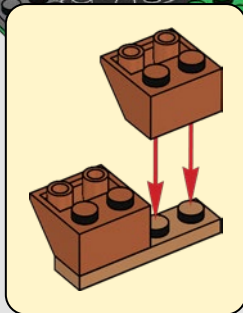

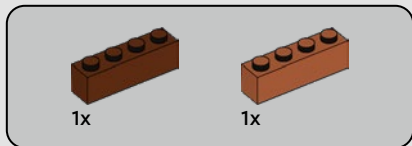

307



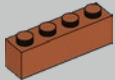

1x



1x

308



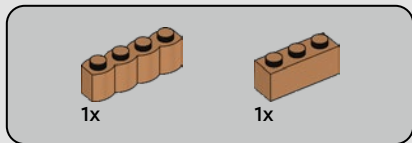

309



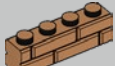

1x



2x

310





1x



1x

311

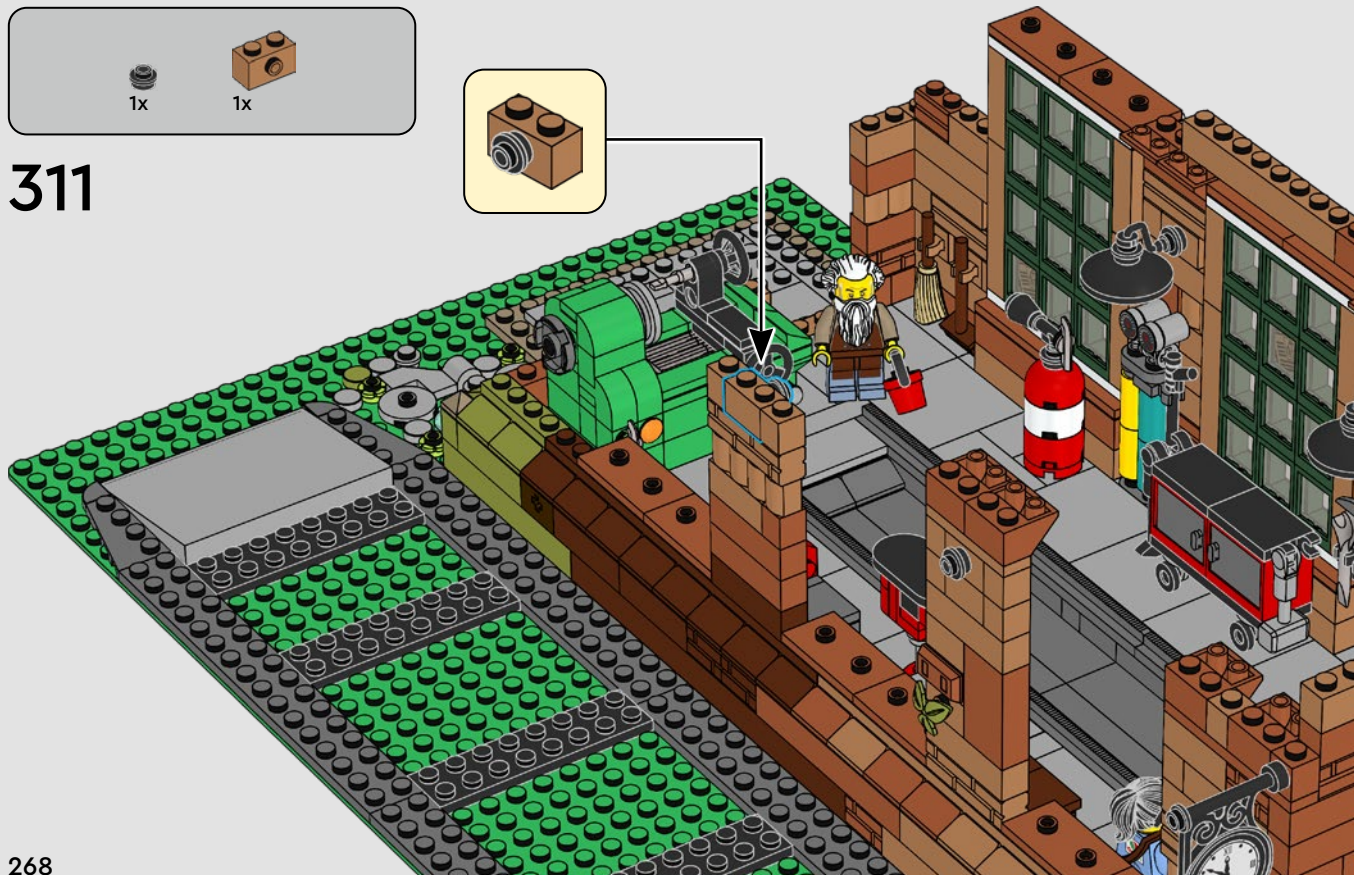



1x



1x

312



1x



1x

313





1x



2x

314

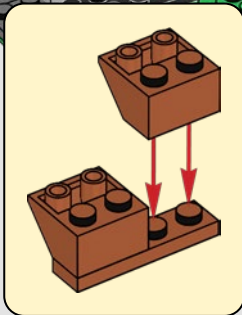
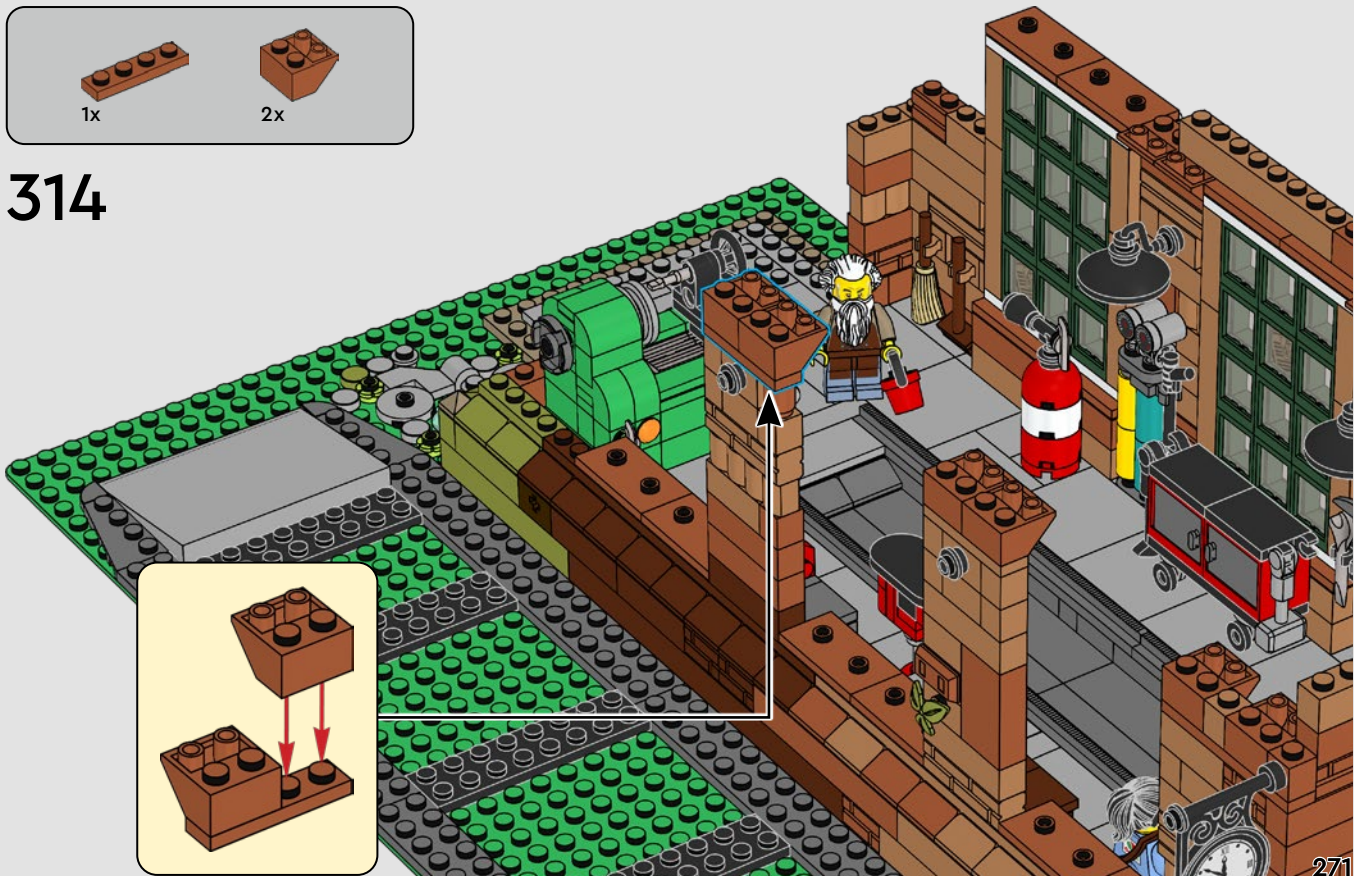

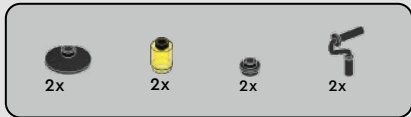

315

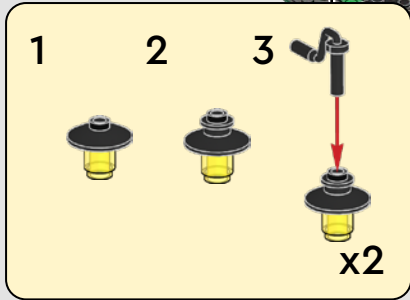
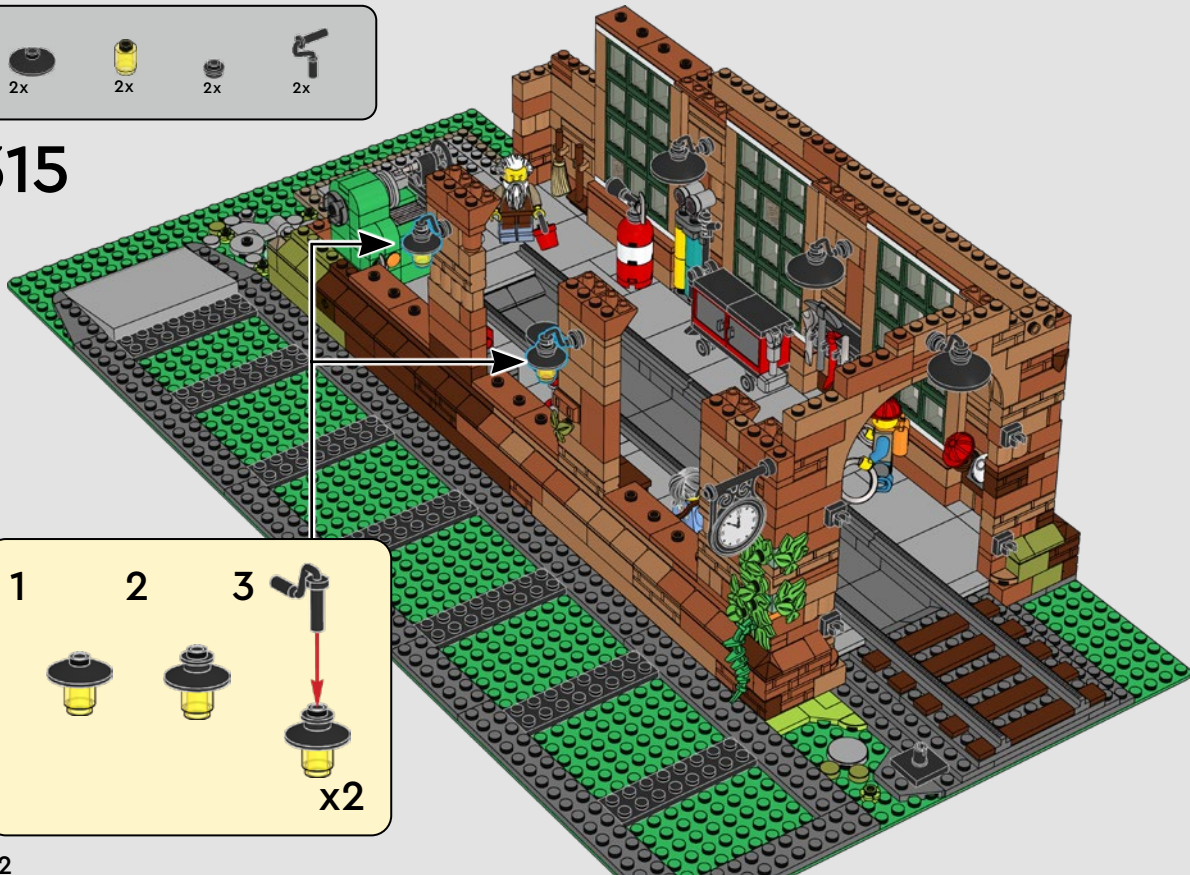

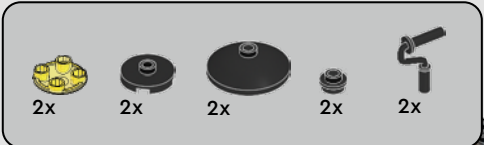

316

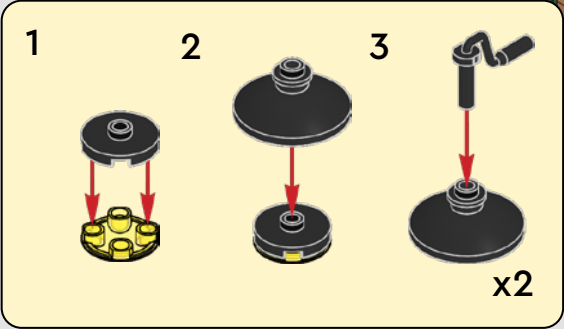
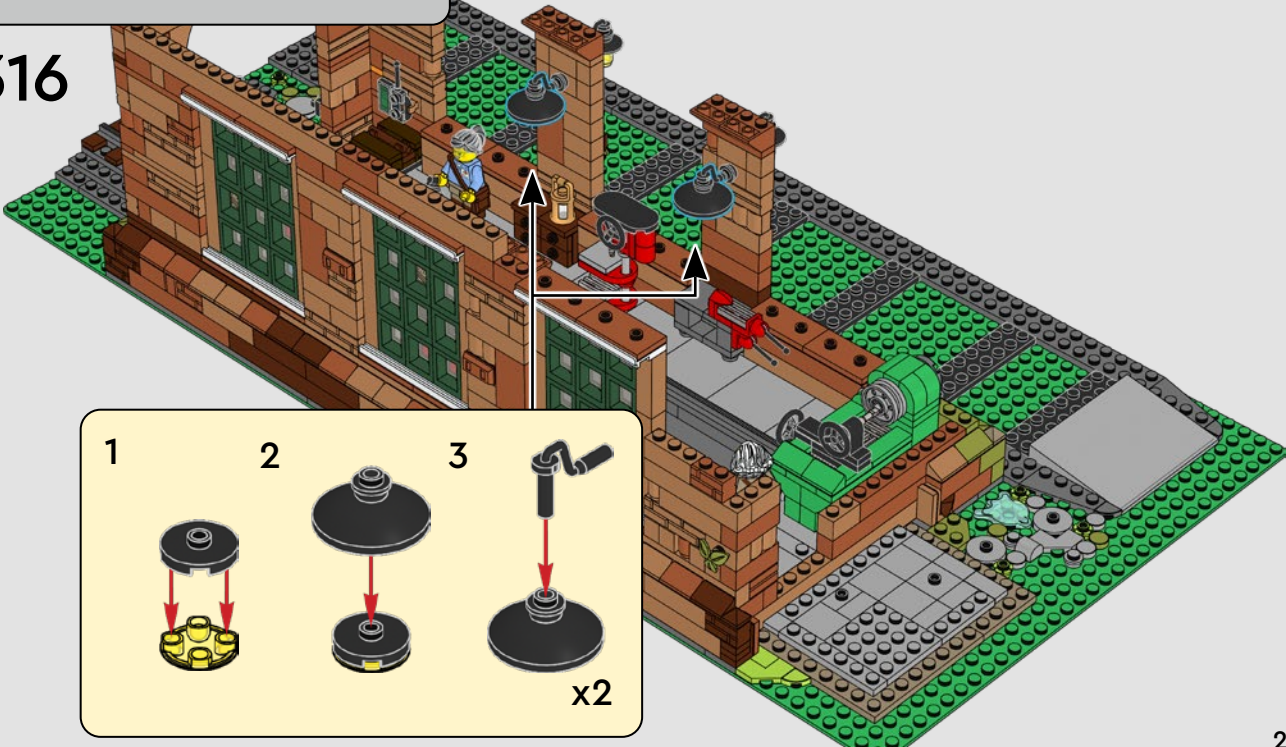

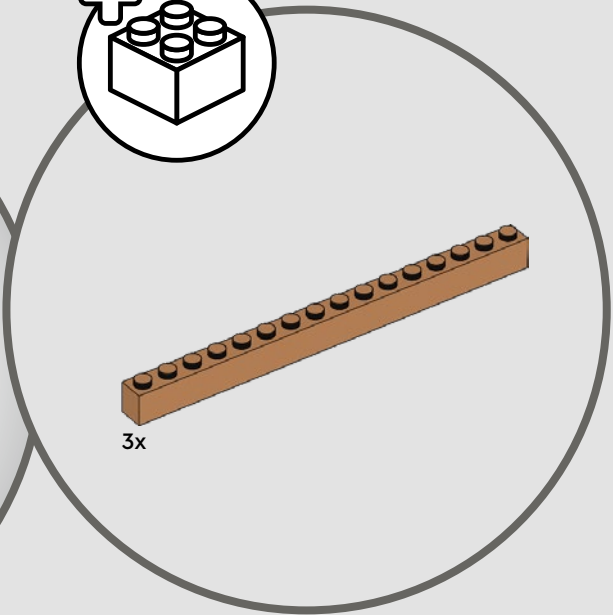
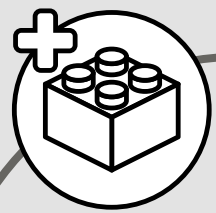

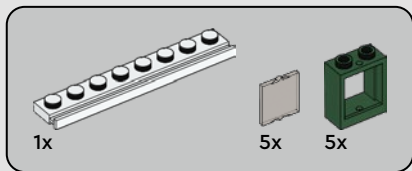
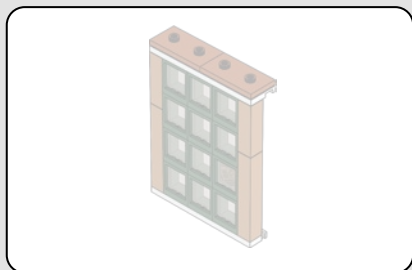

317

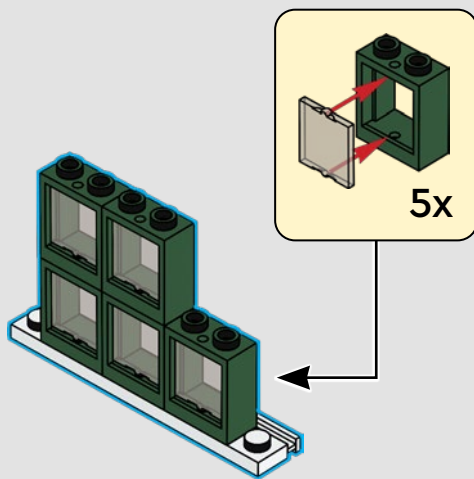

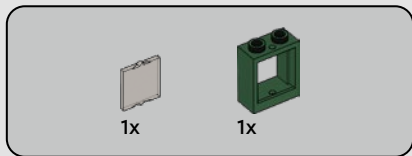

318

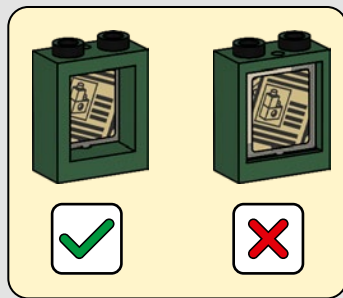
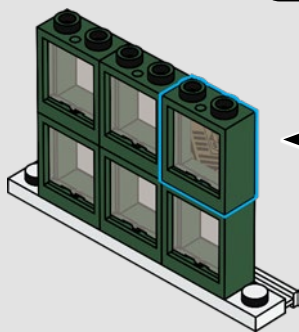
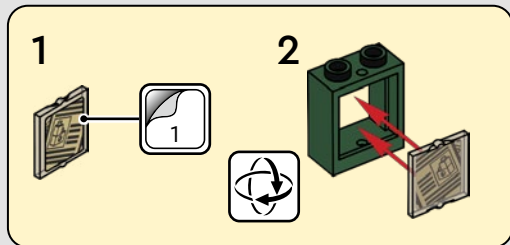

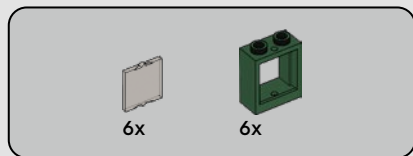

319

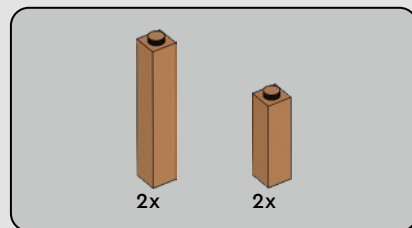
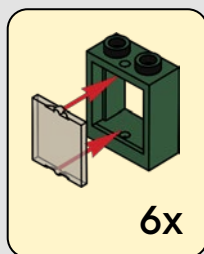
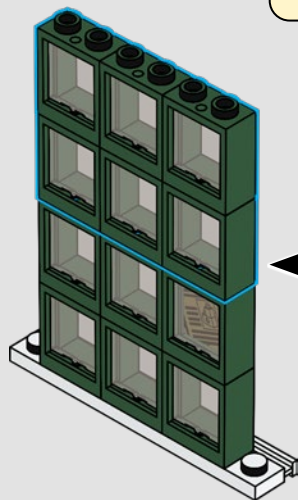

320

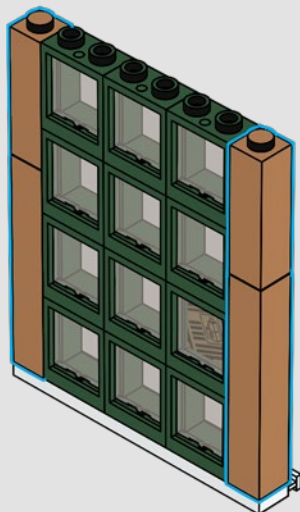

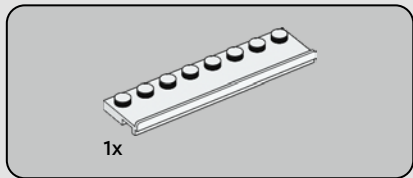

321

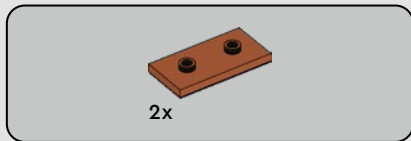
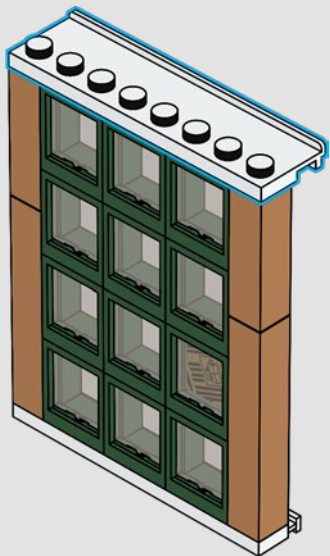

322

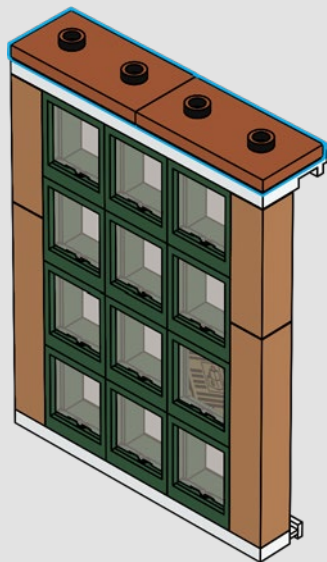

323

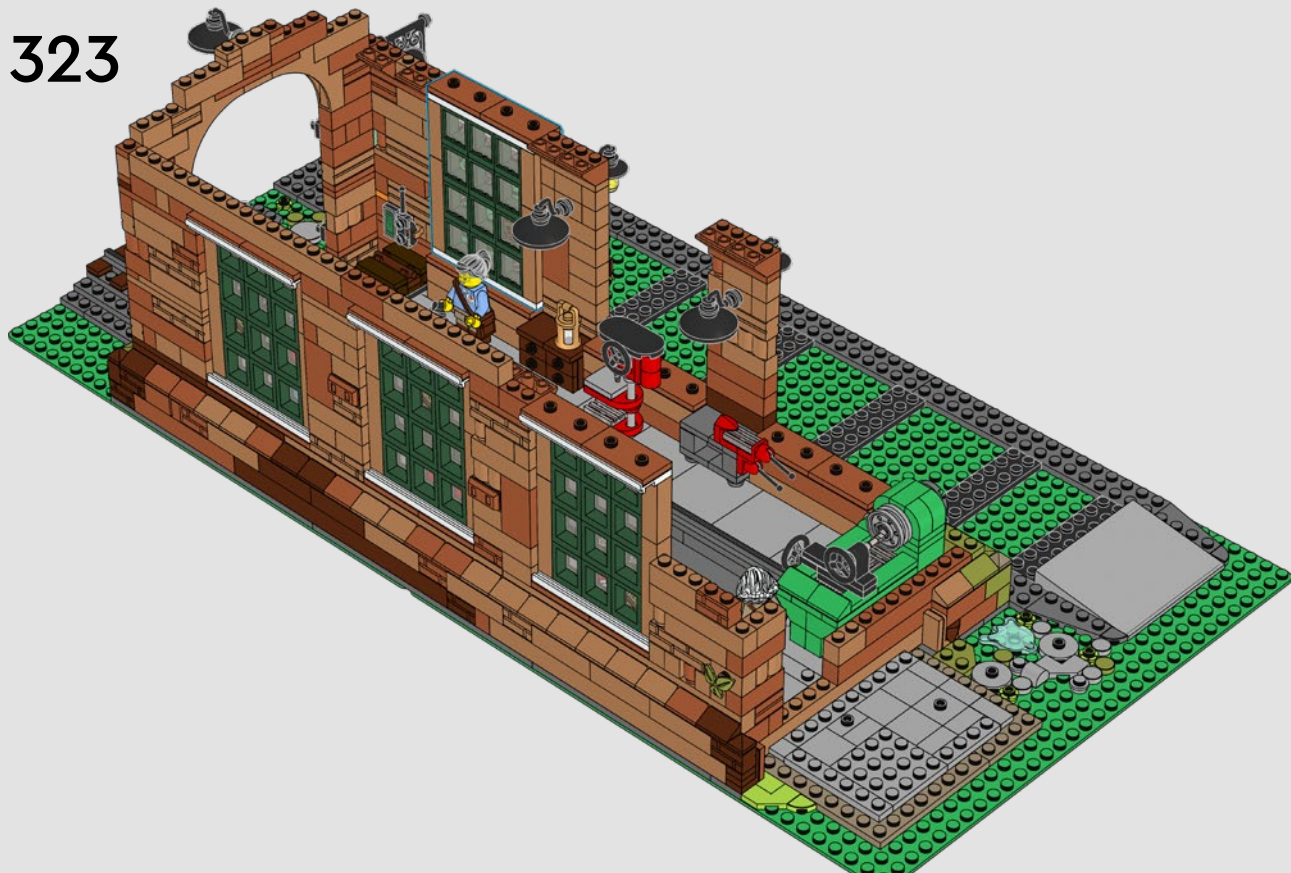

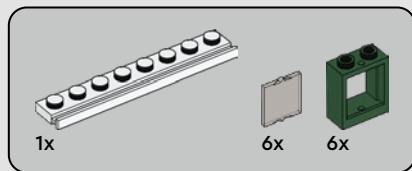
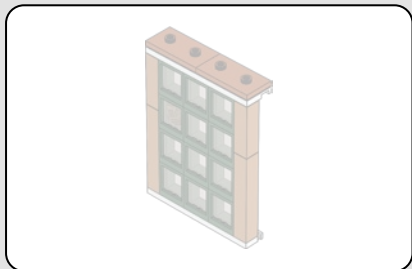

324

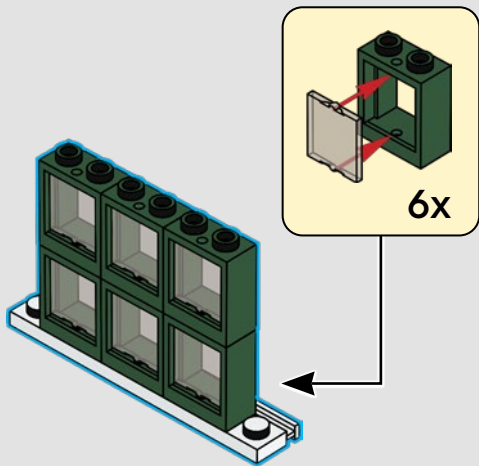

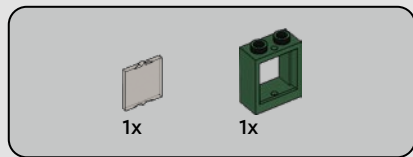

325

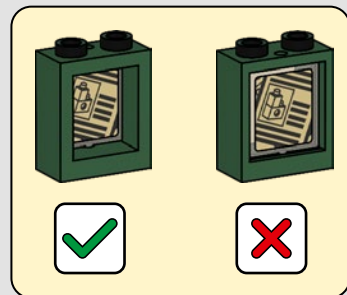
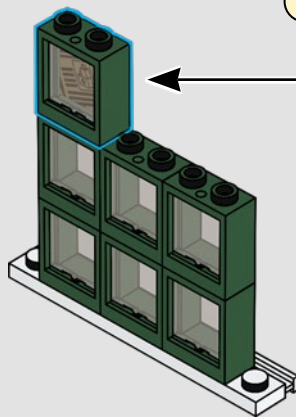
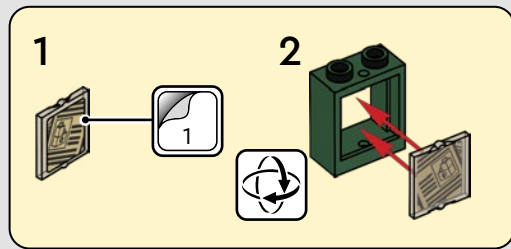

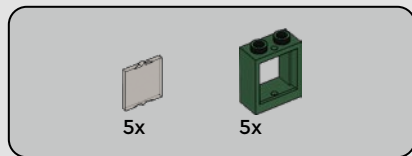

326

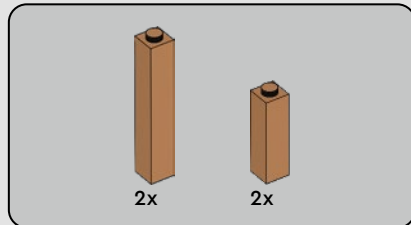
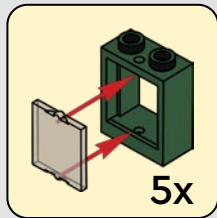
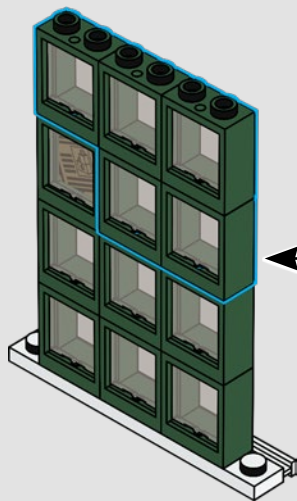

327

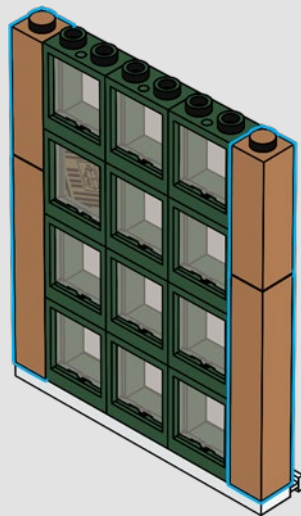

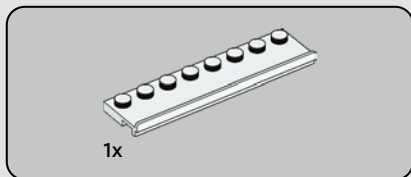

328

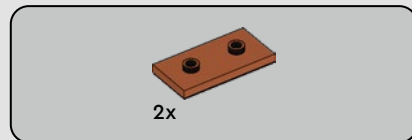
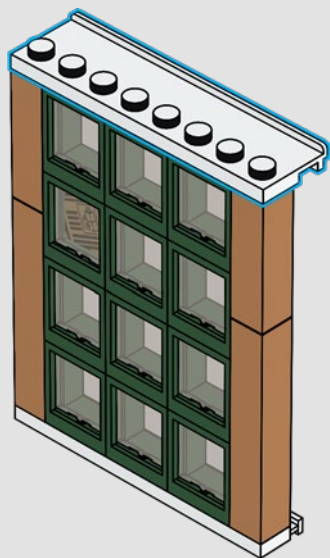

329

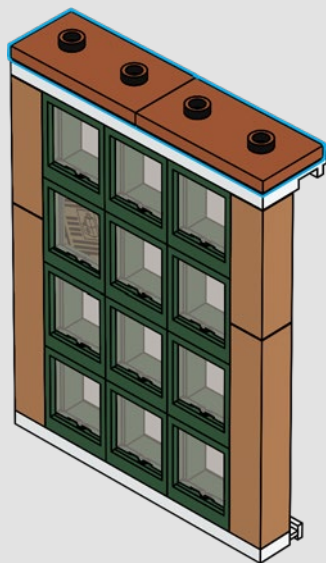

330

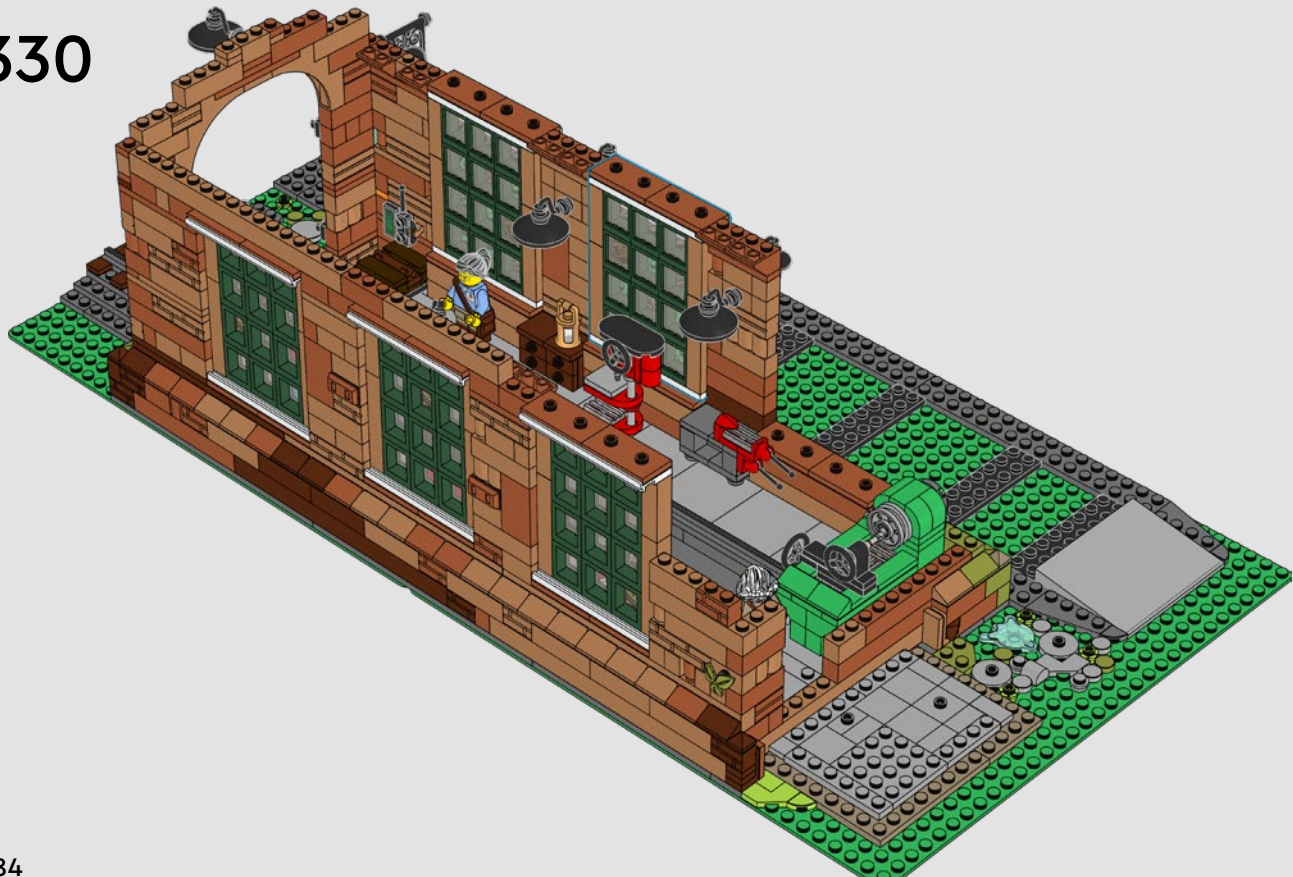

284



331

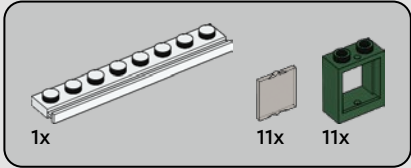
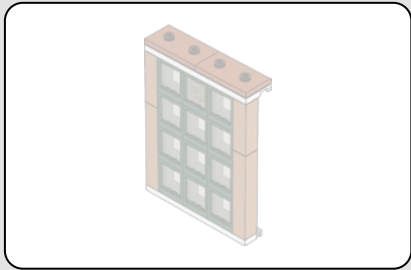

332

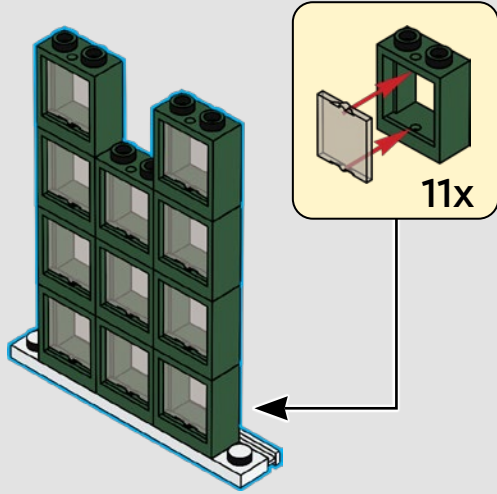

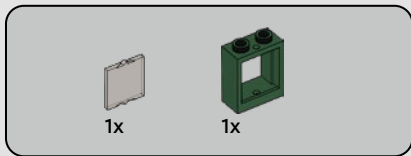

333

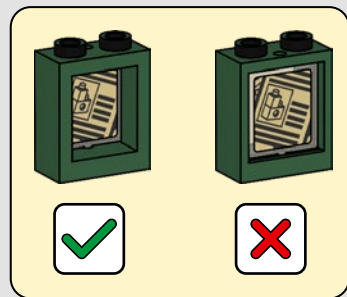
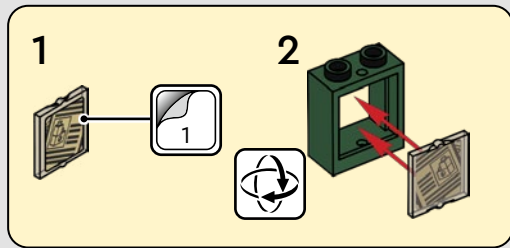
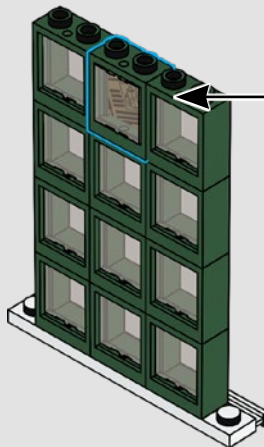

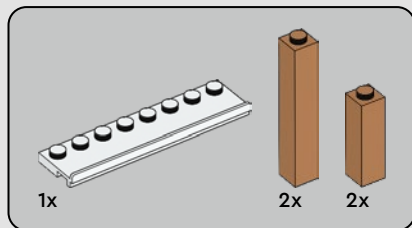

334

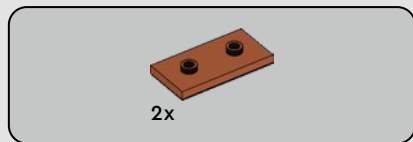
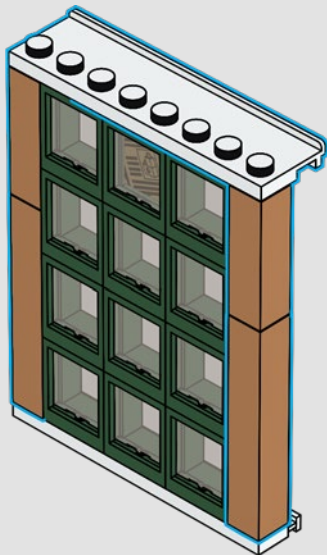

335

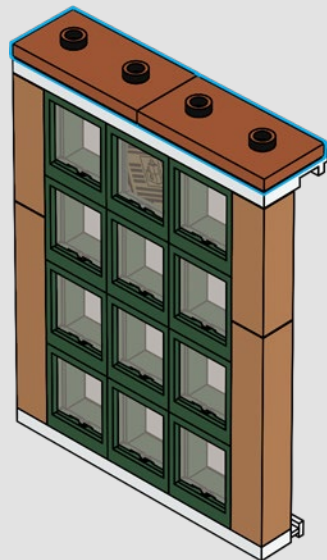

336

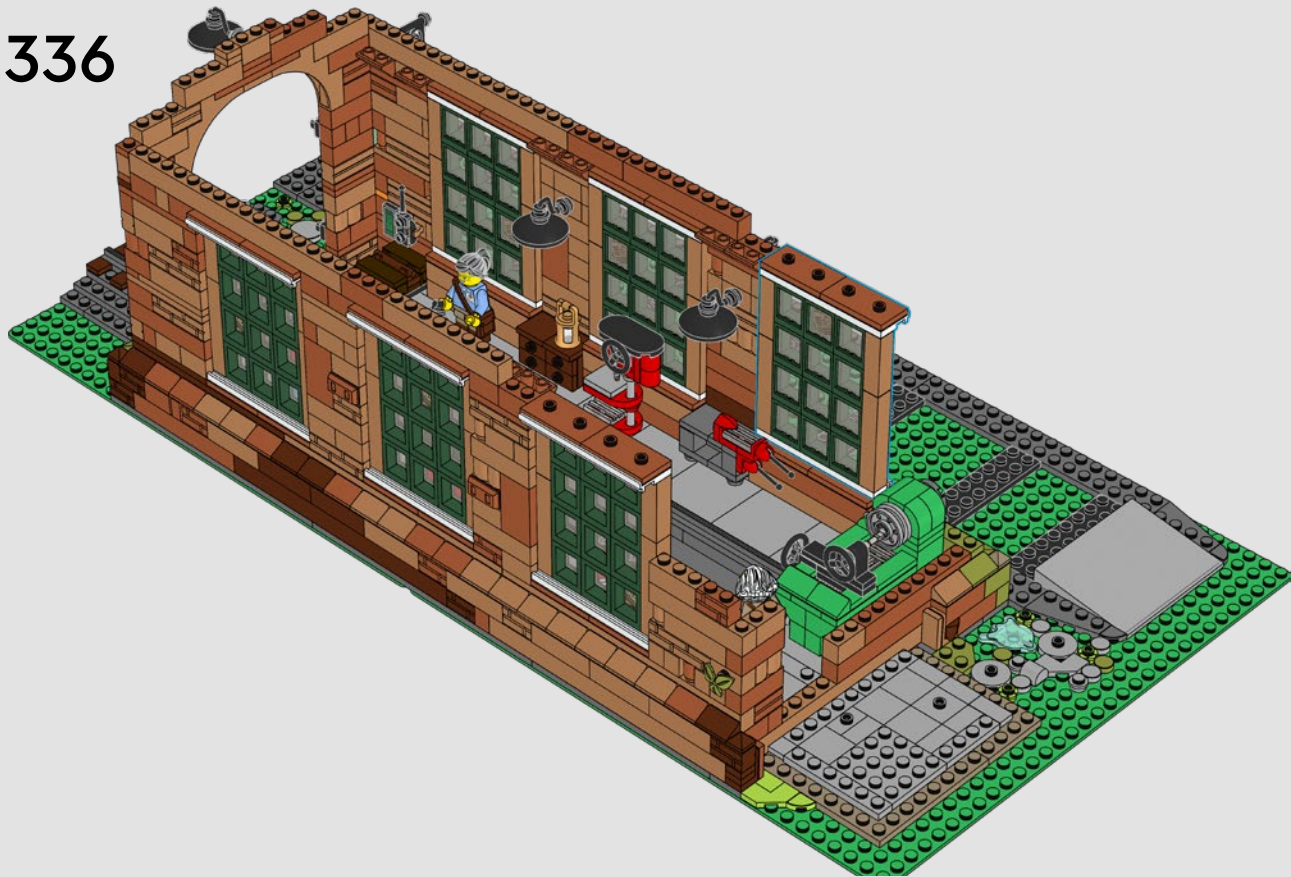

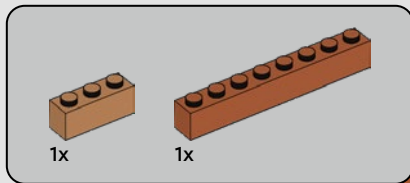

337

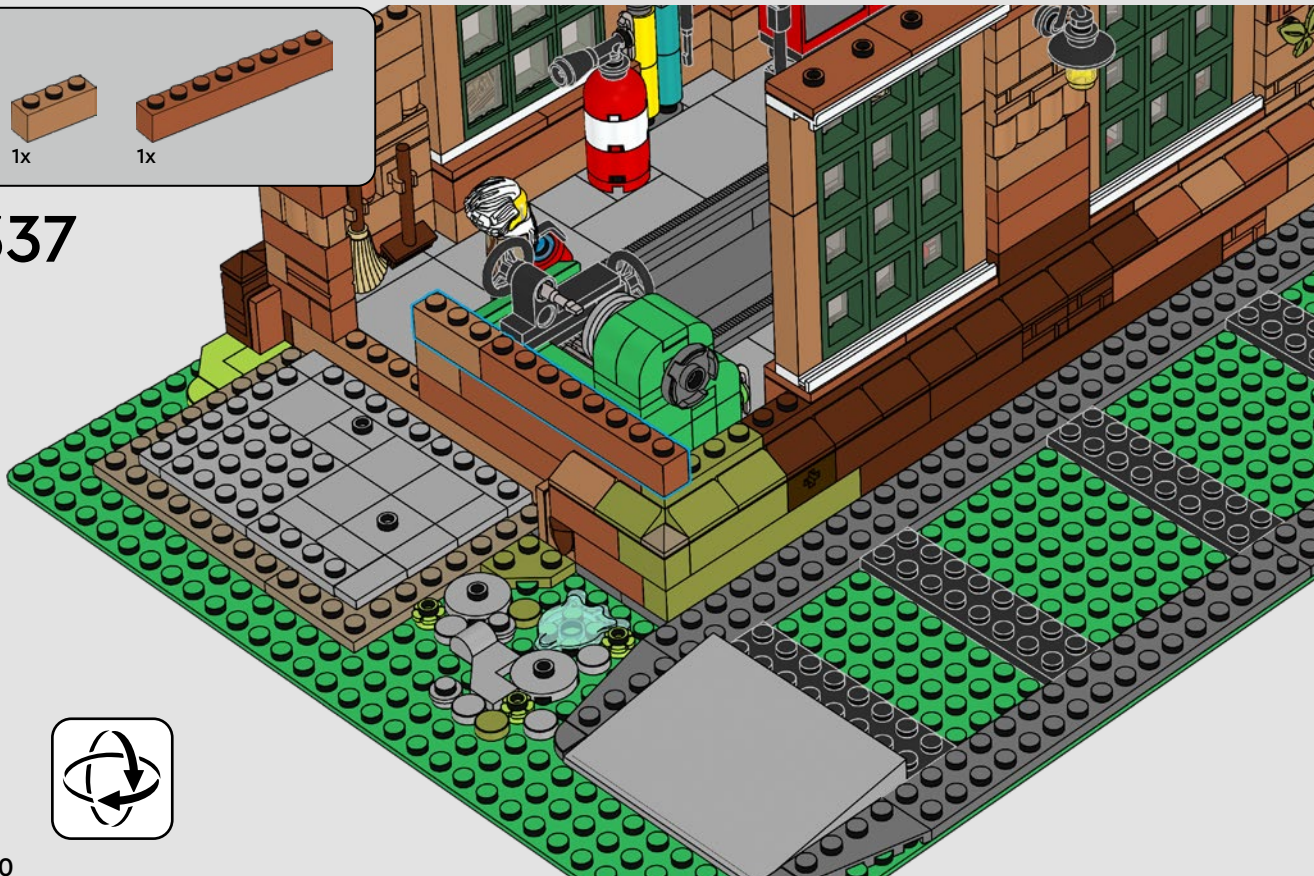

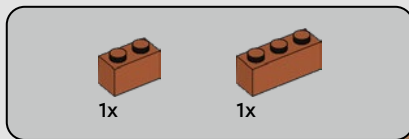

338



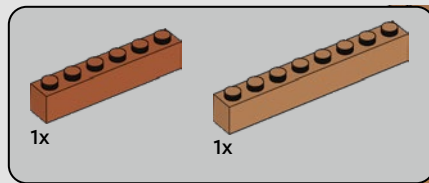

339





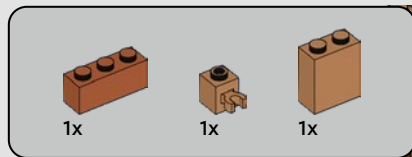

341





342

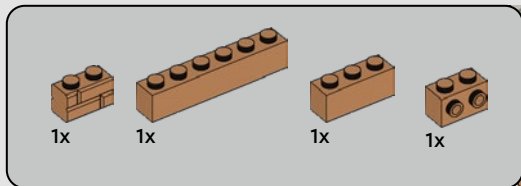

343



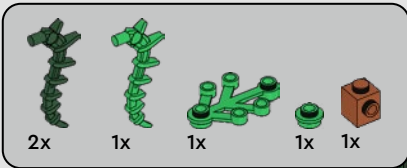

344

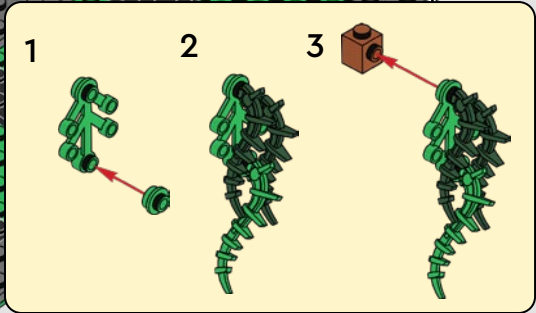

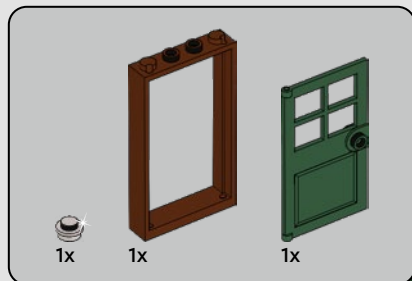

345



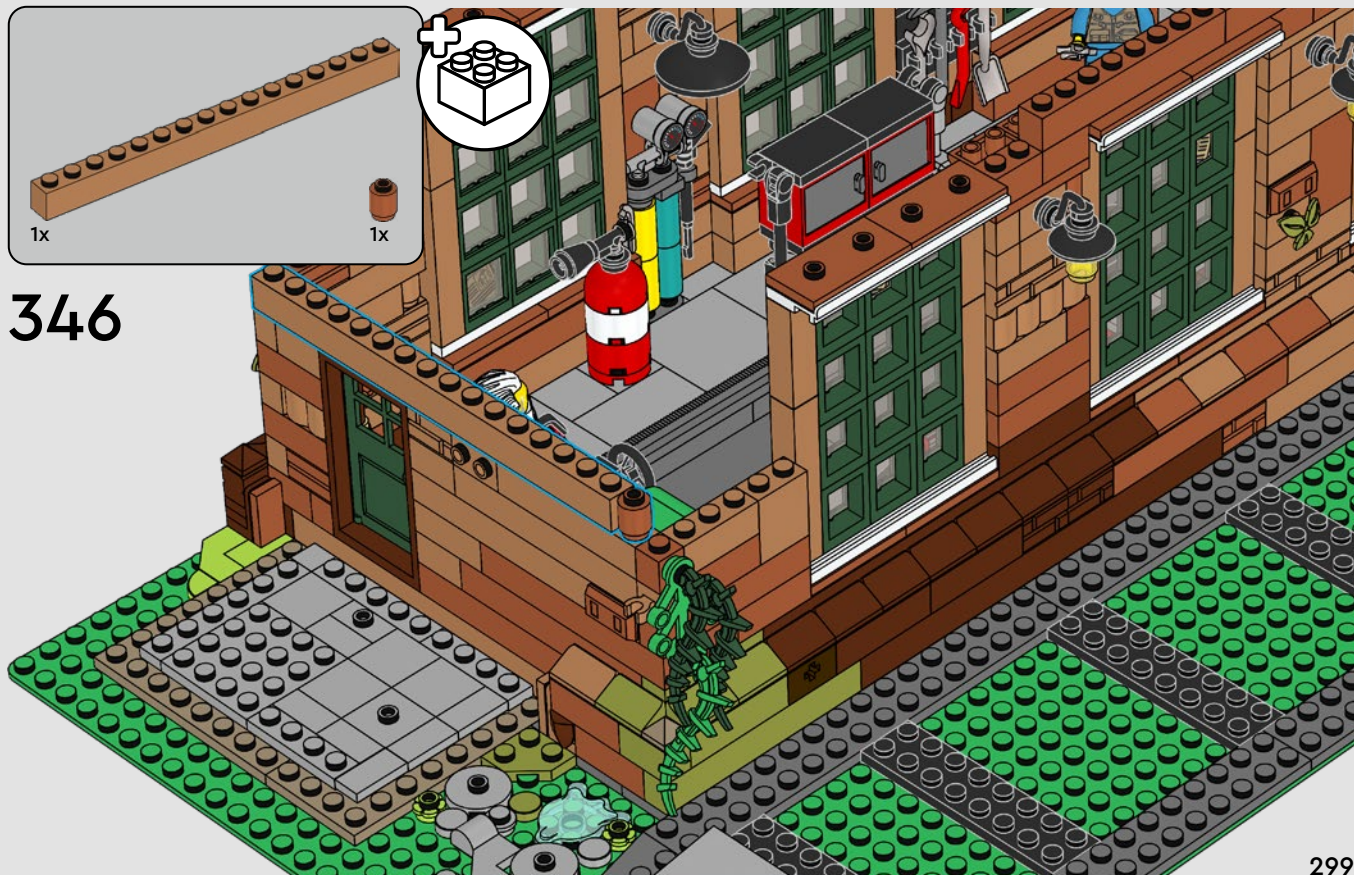



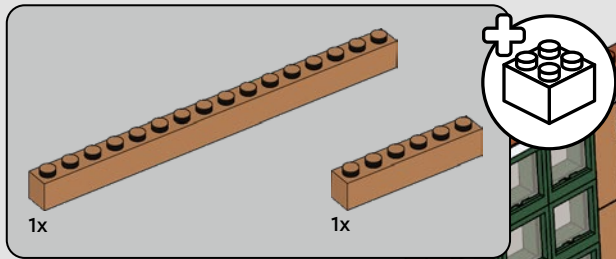

348





3x



1x

349

1

2



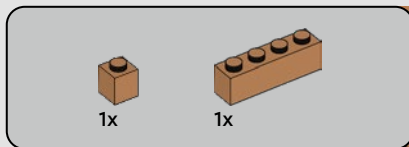

350



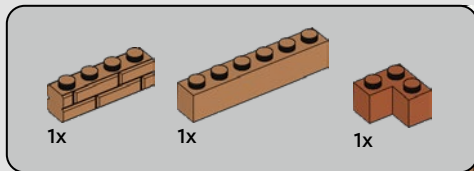

351



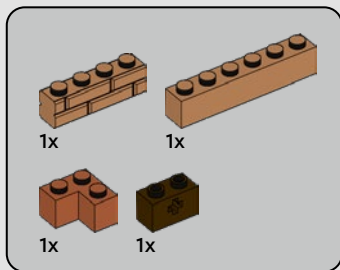

352



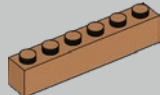

2x

353



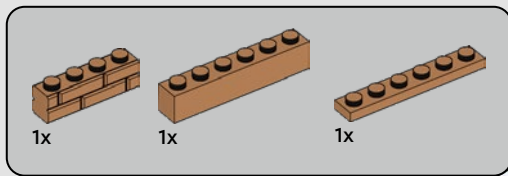

354

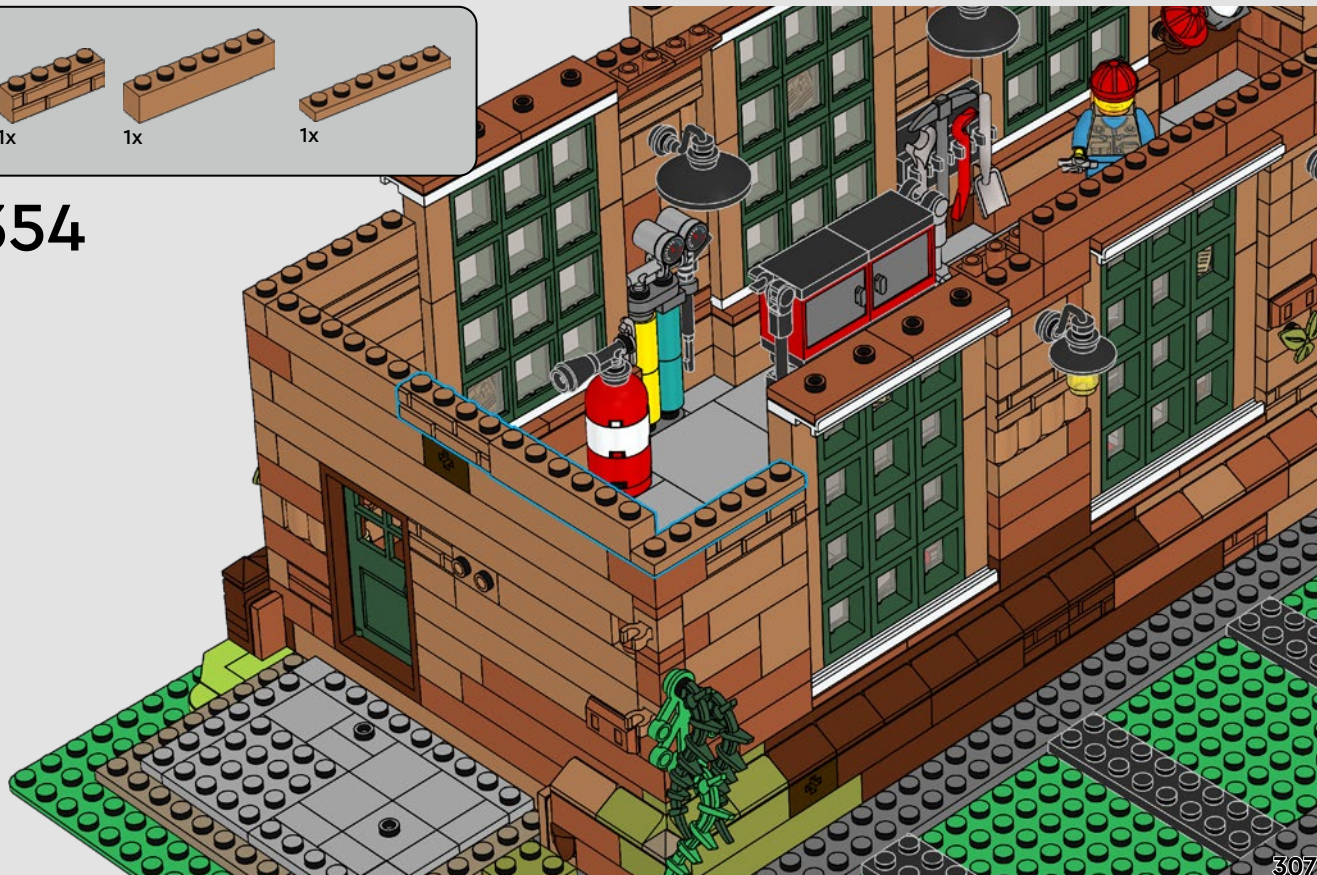

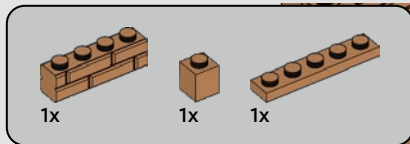

355



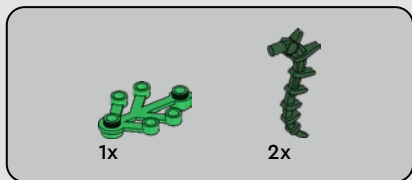
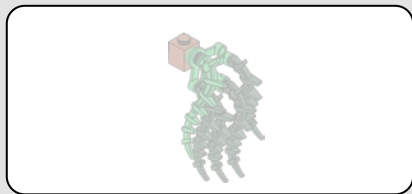

356

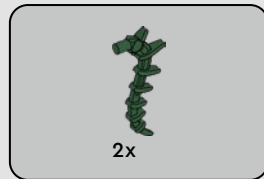

357

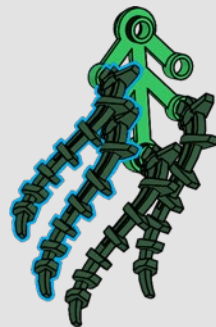

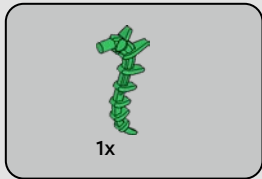

358

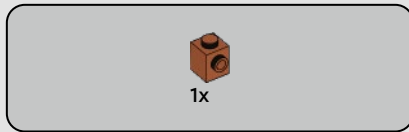

359

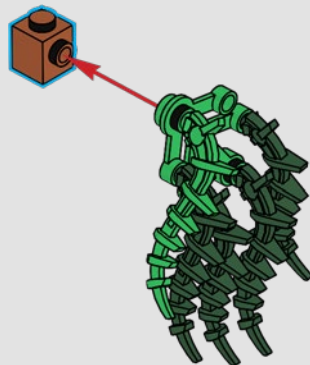

360



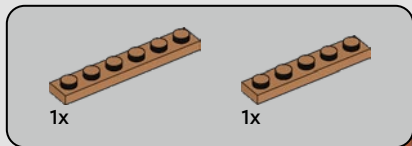

361



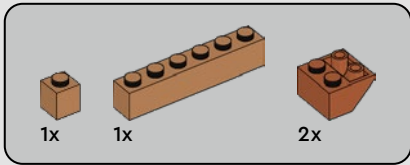

362

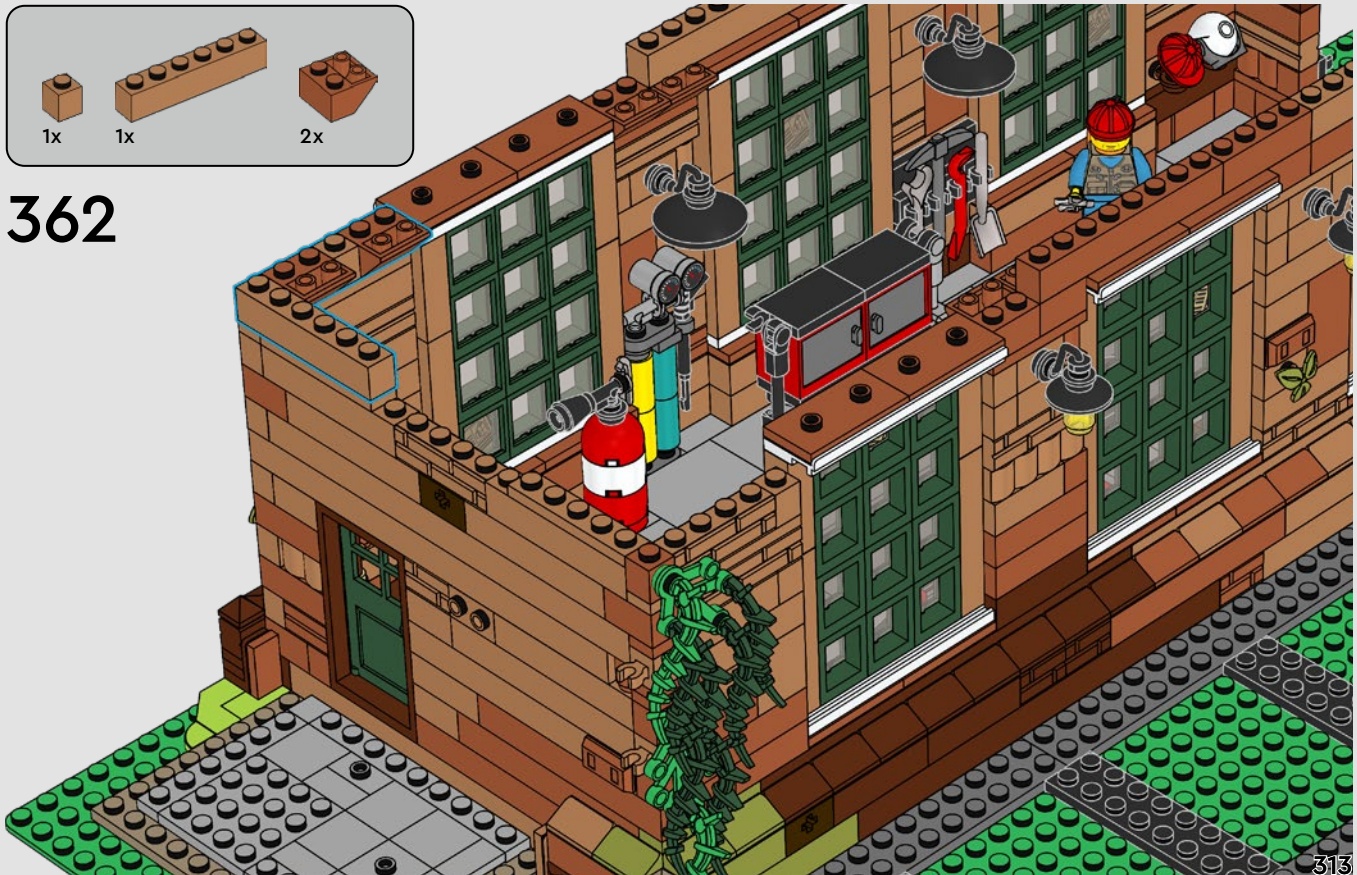

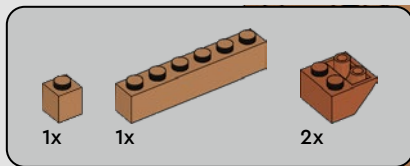

363



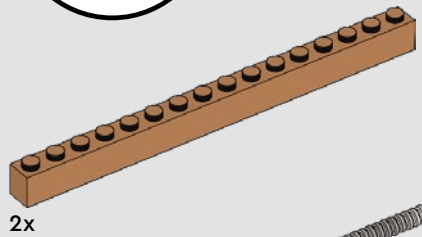
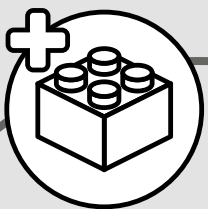

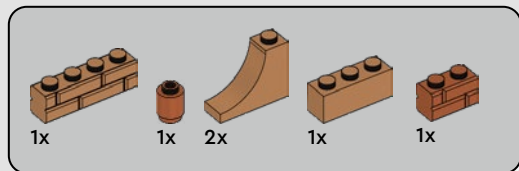

364

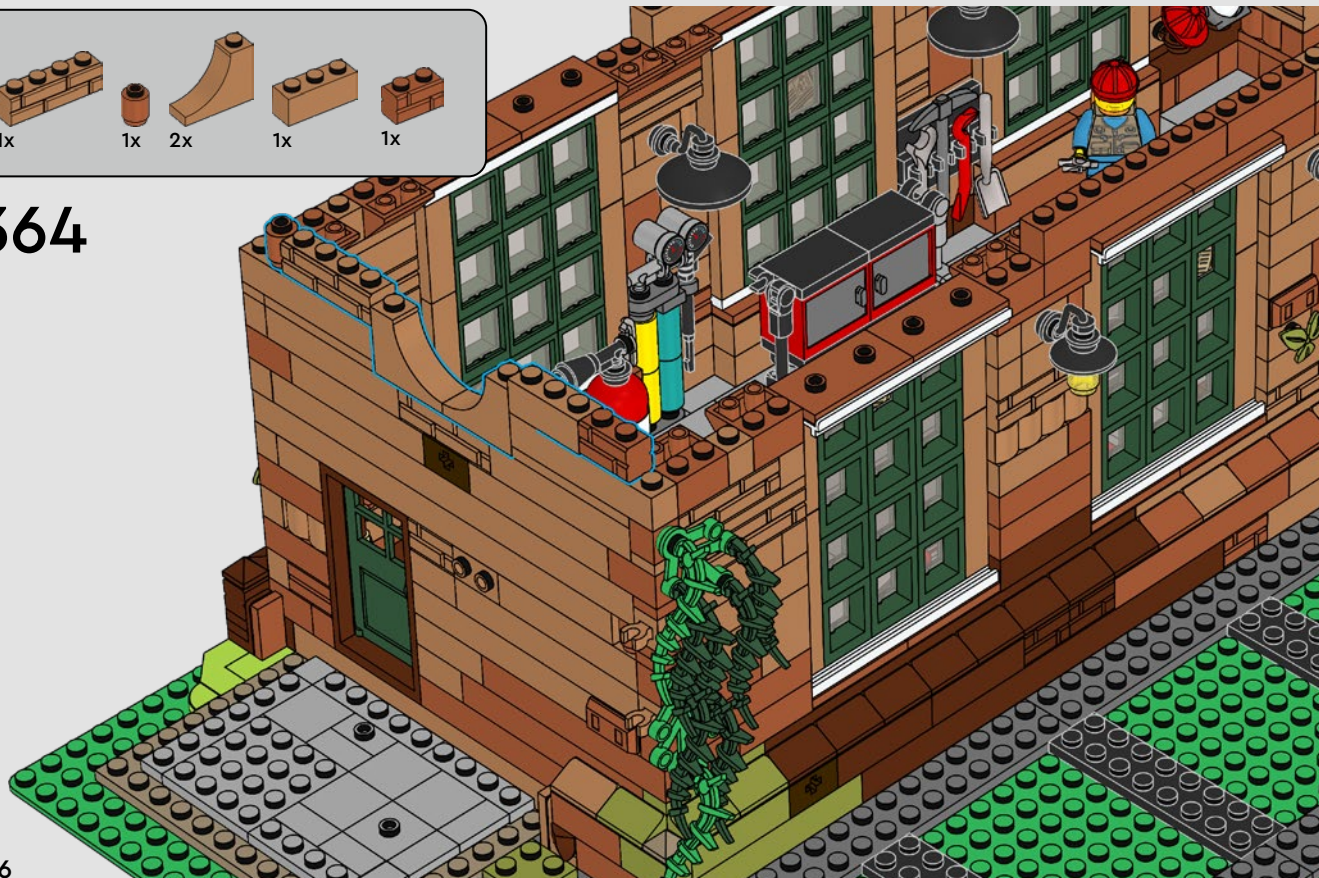

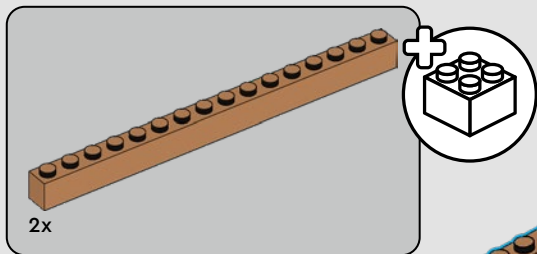

365



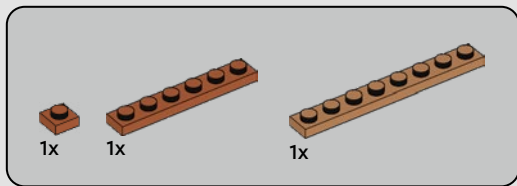

366

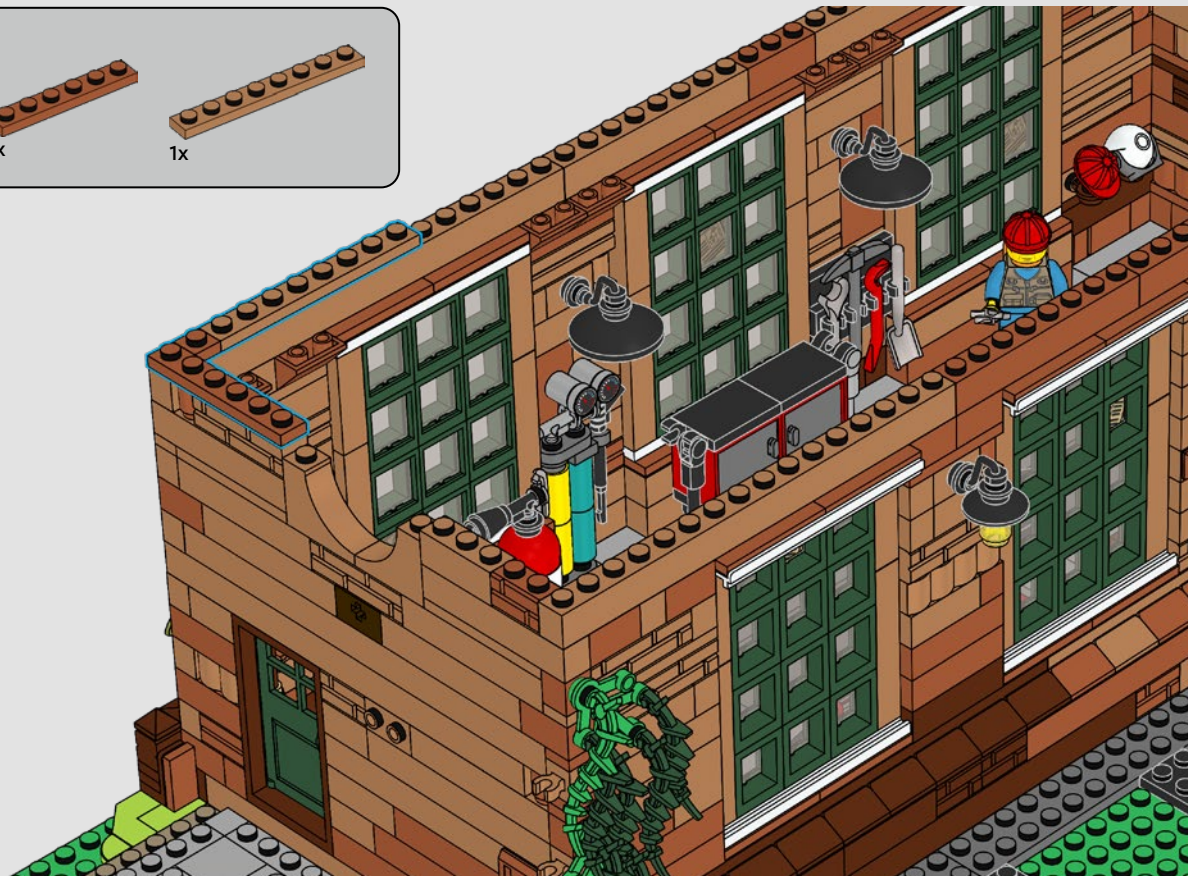

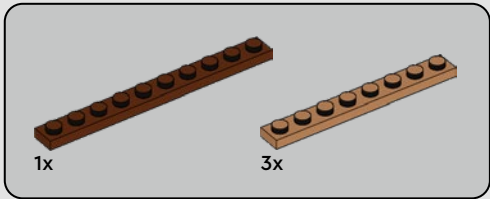

367

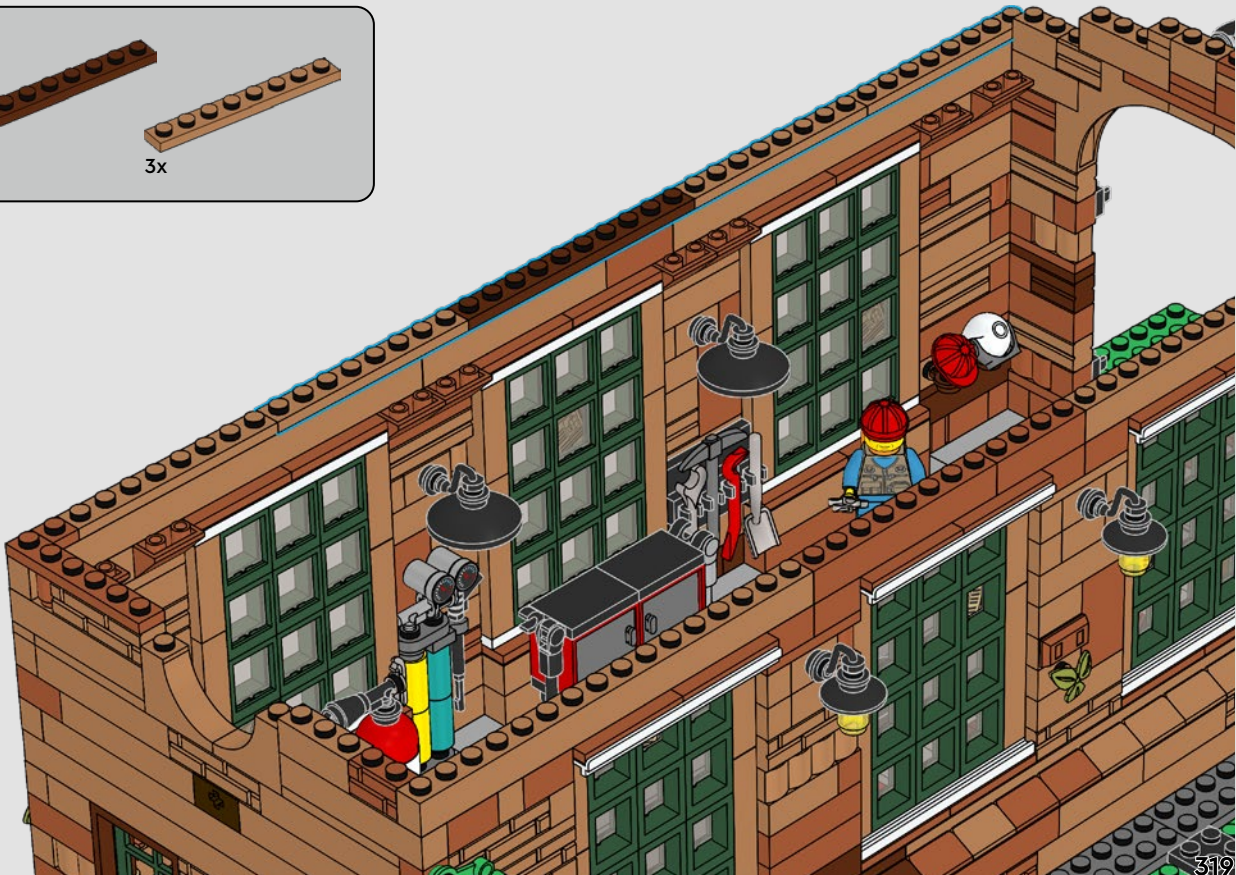



1x



5x

368



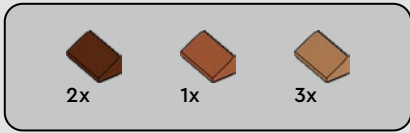

369





3x



2x

370

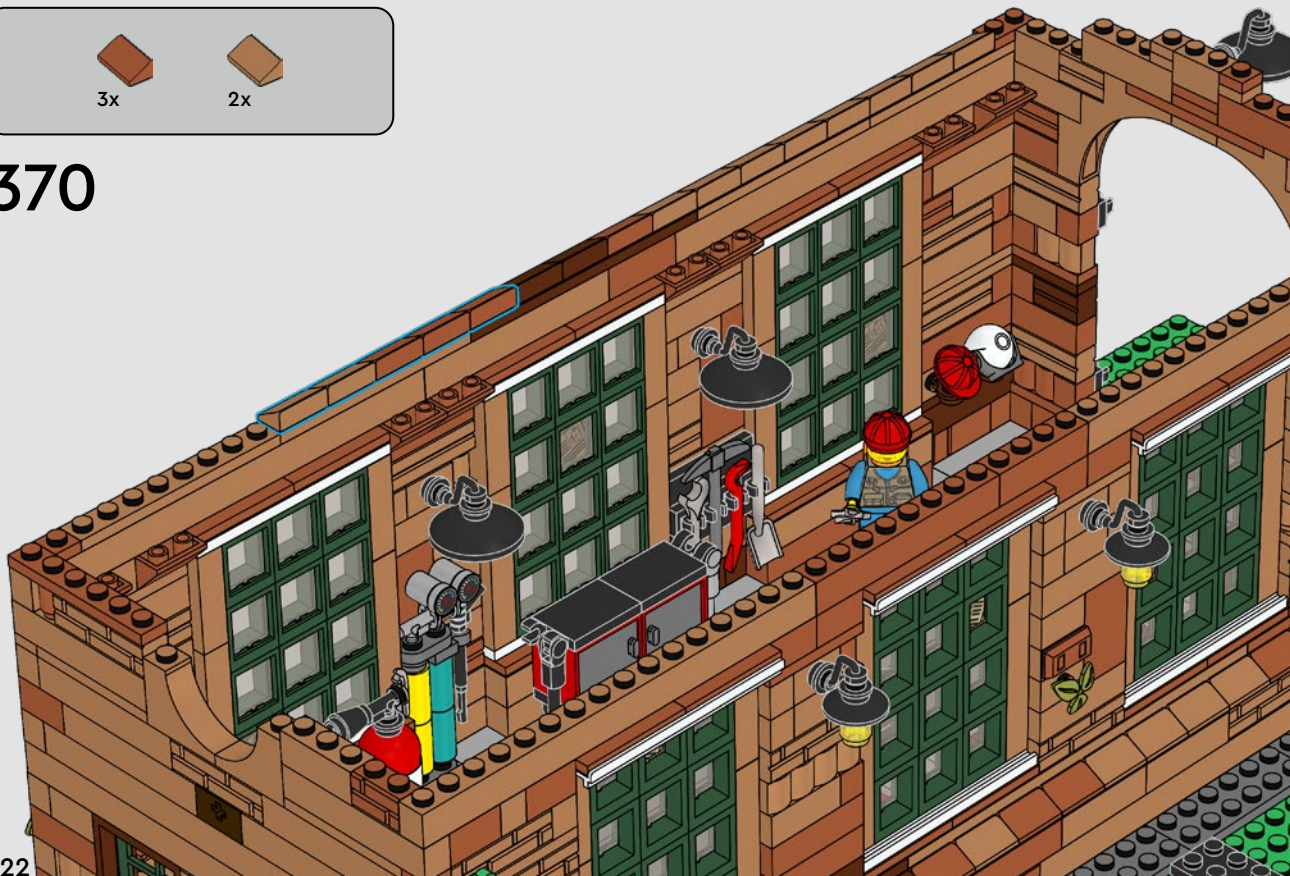



1x



4x

371



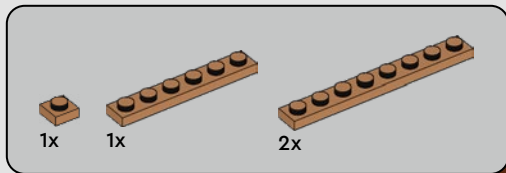

372



324

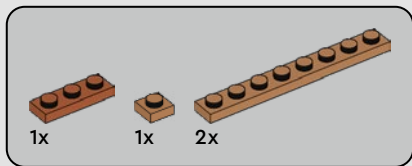

373



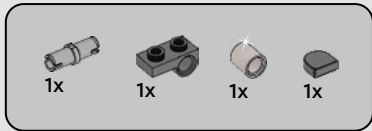

374

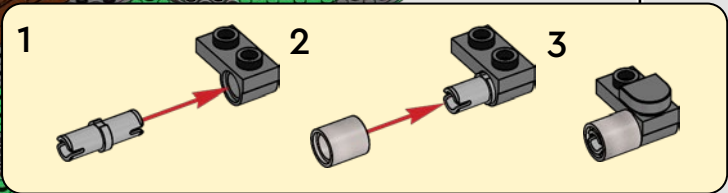
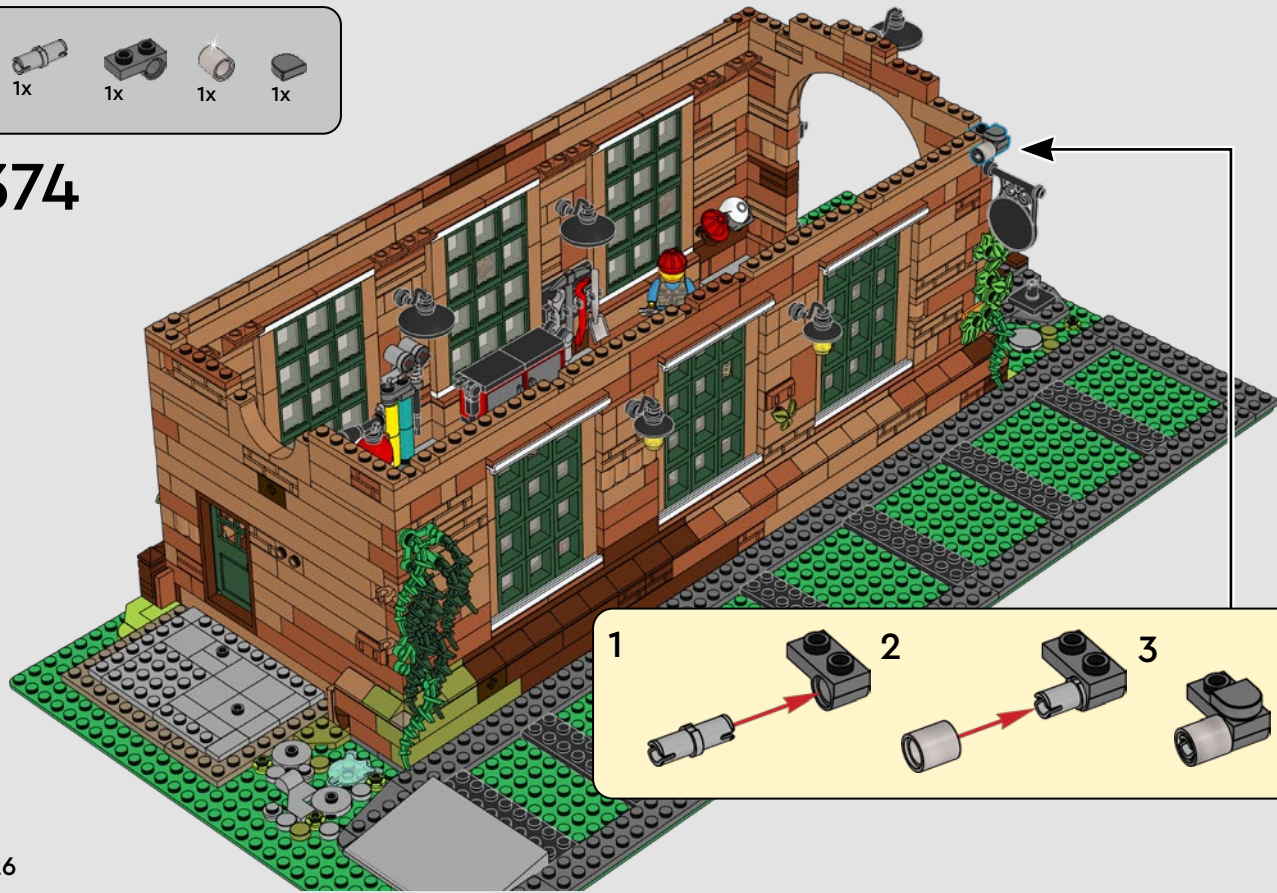



1x



1x

375

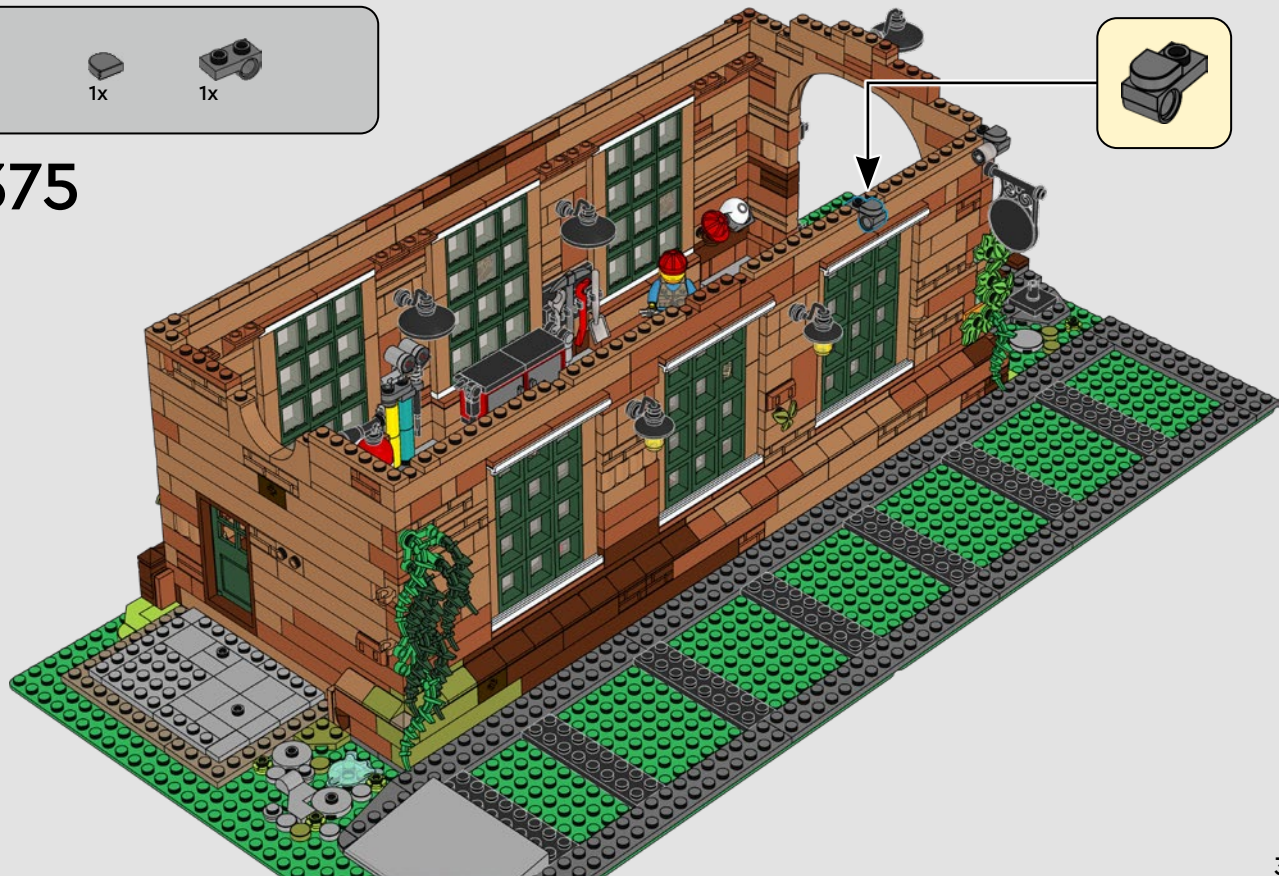



1x



1x

376



1x



1x

377

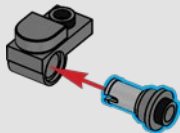

1x

378

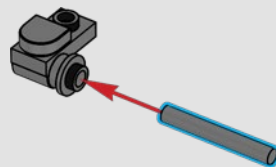

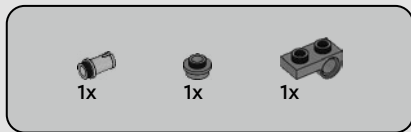

379

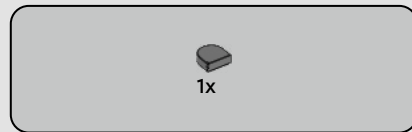
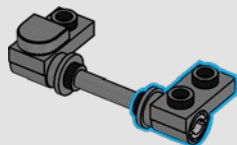

380

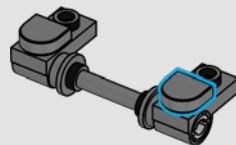

381



330



1x



1x

382



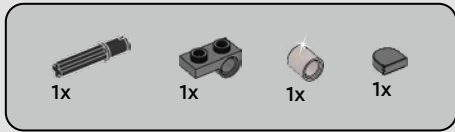

383

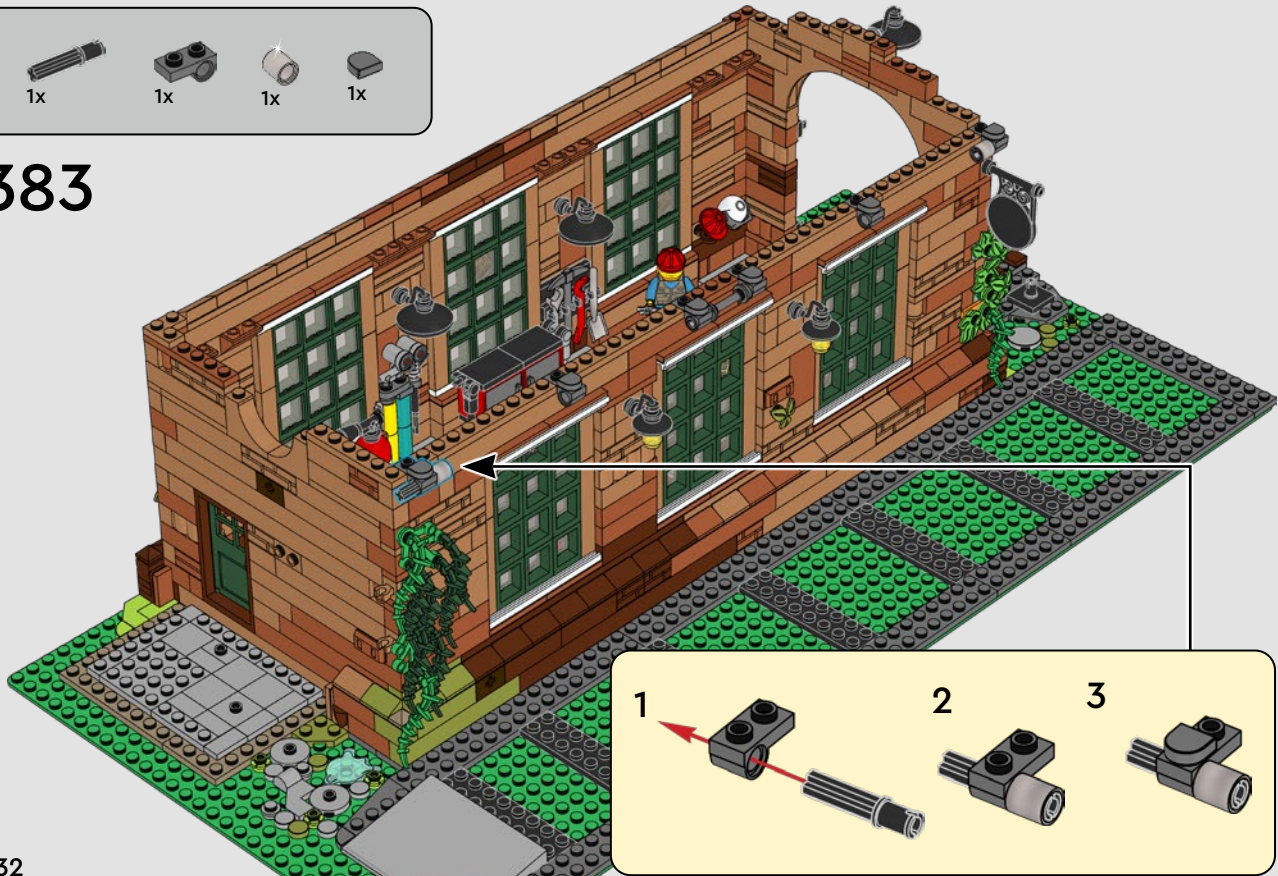

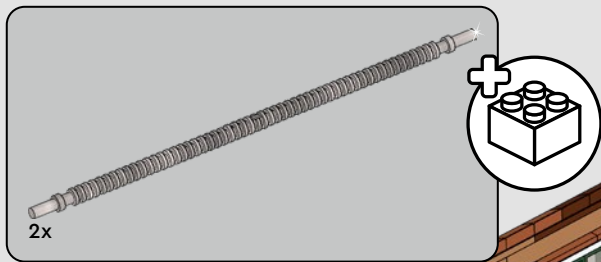

384



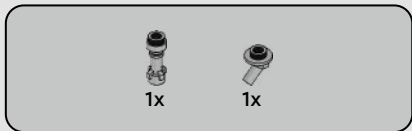

385

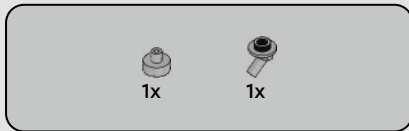

386

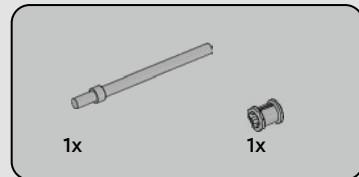

387

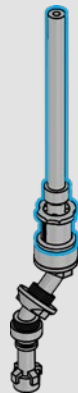



2x



1x

388

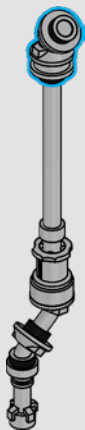

1x



1x

389

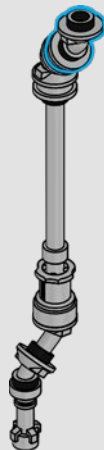

1x



1x

390

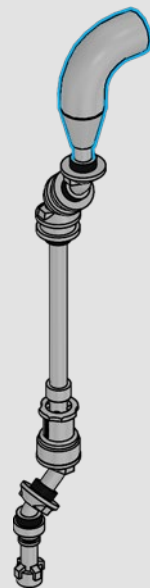

391



336

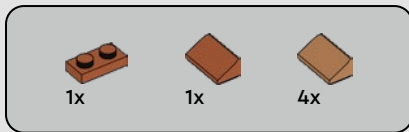

392





6x

393



338



1x



1x



8x

394



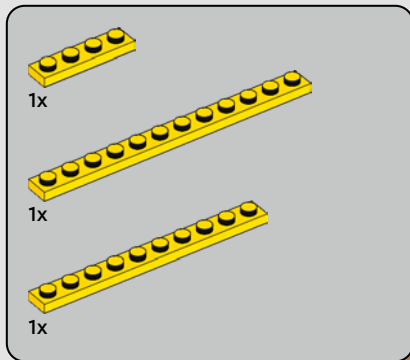

395

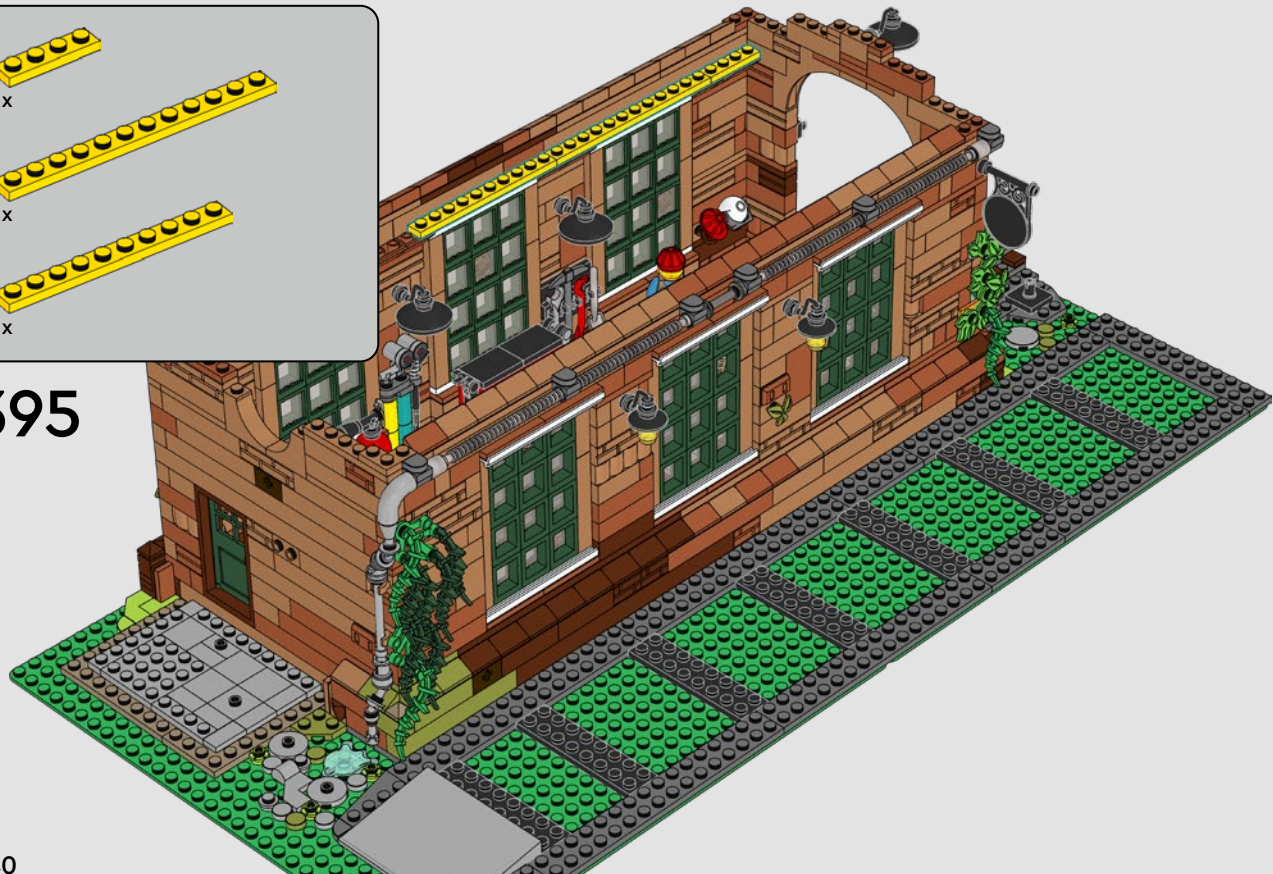

340

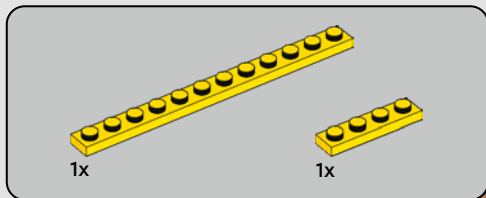

396

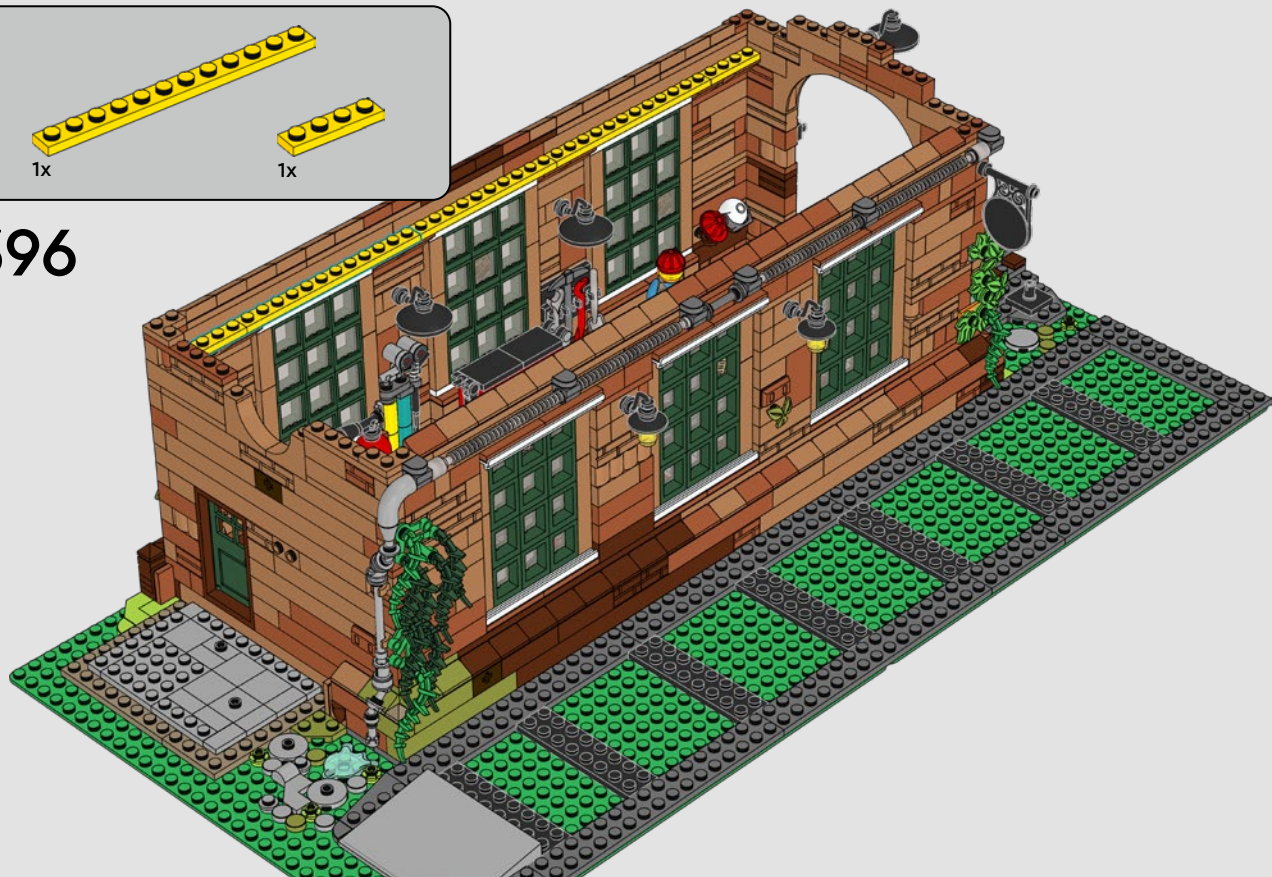

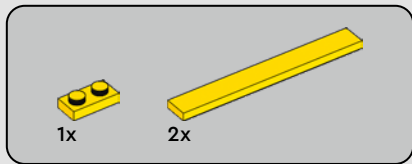

397



342

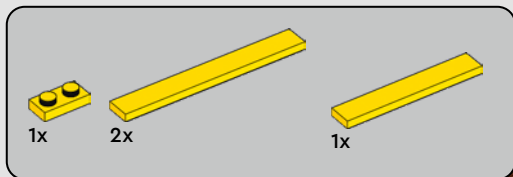

398

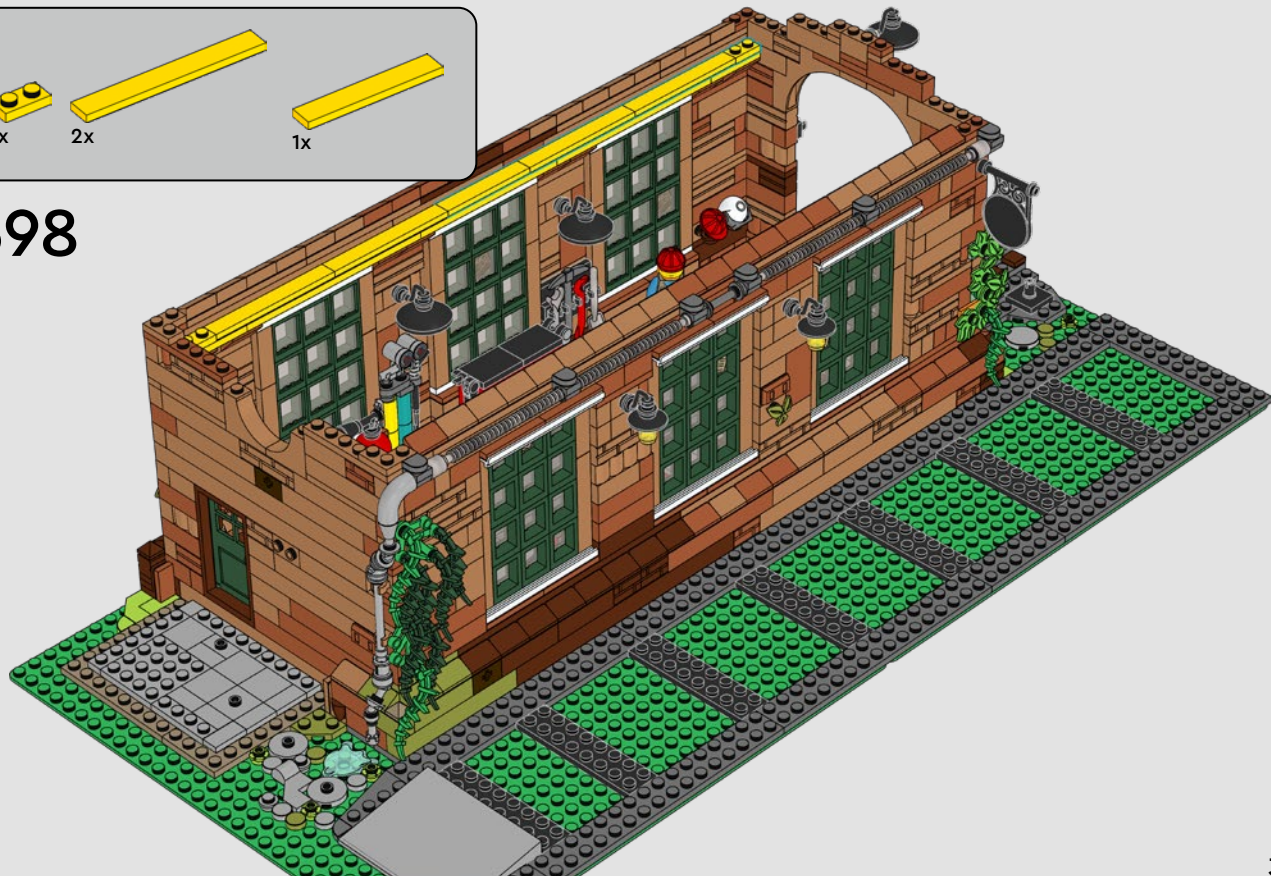

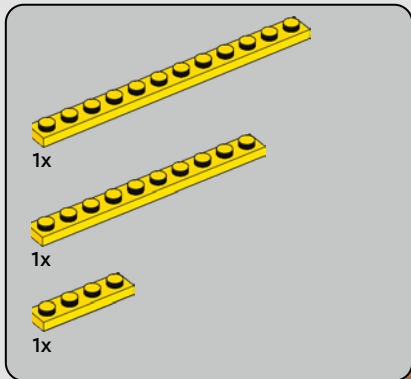

399

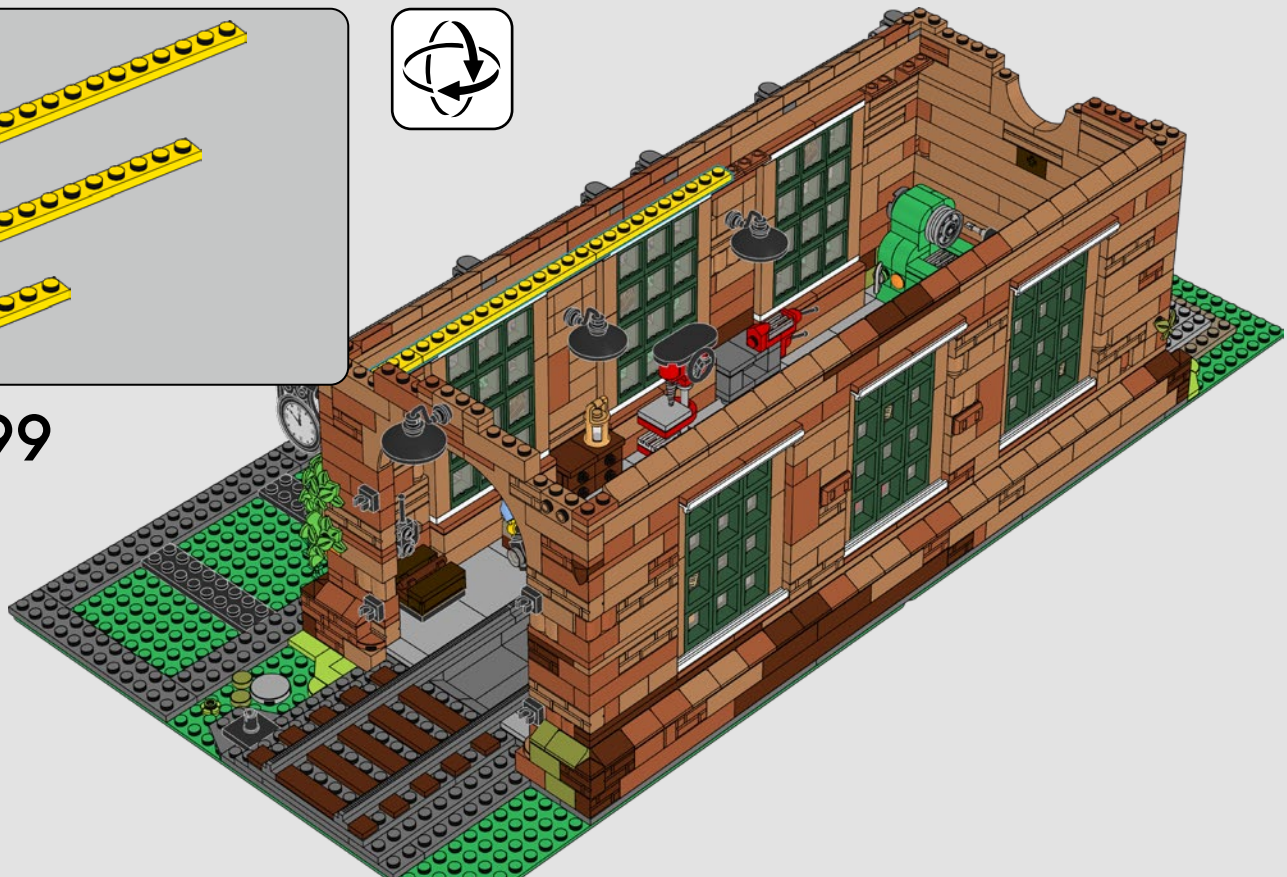

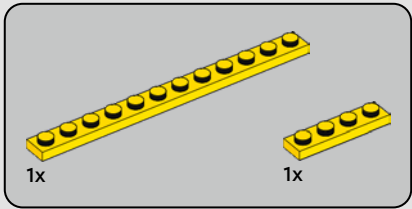

400

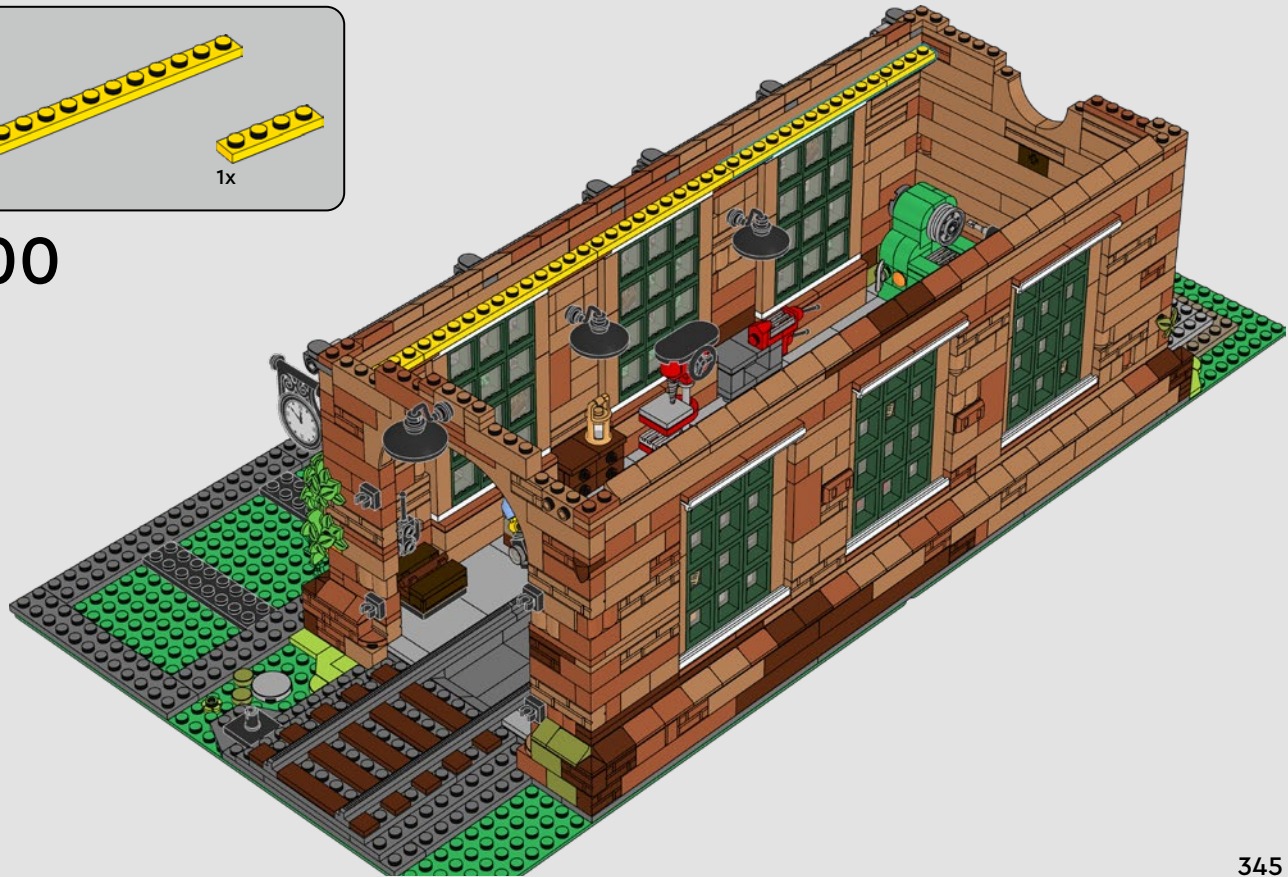

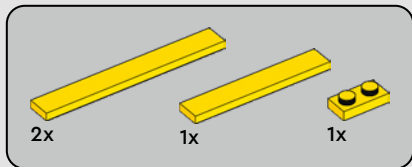

401

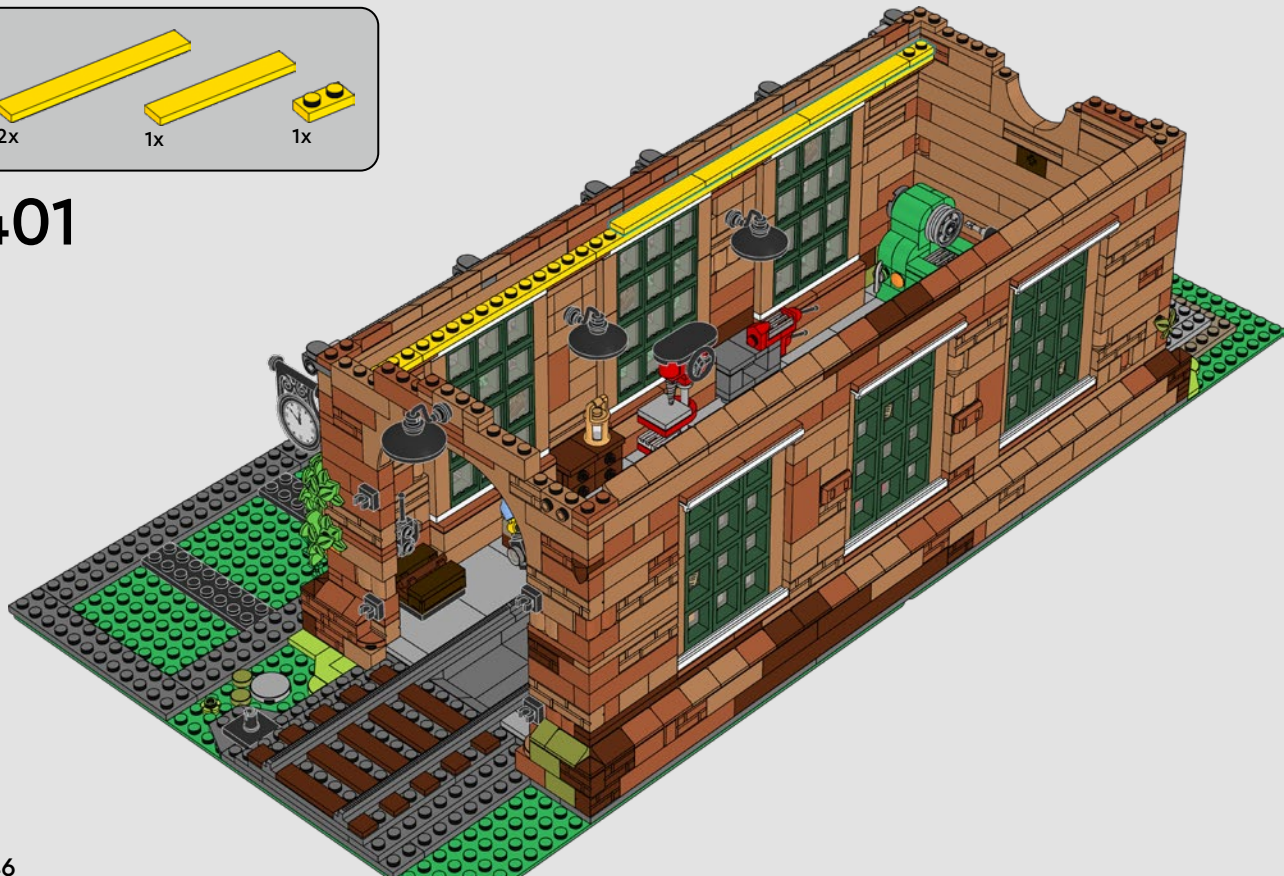

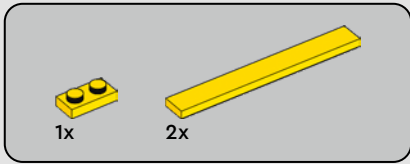

402





1x



1x

403





1x



1x

404





1x



1x

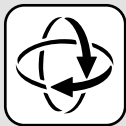

405





1x



1x

406





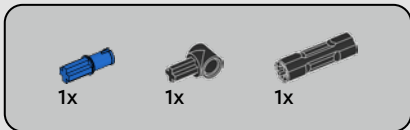
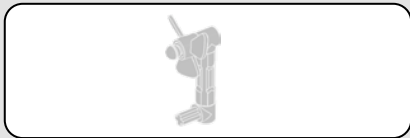

407

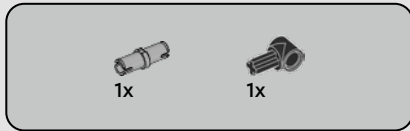

408

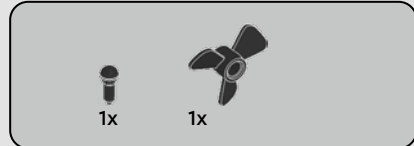
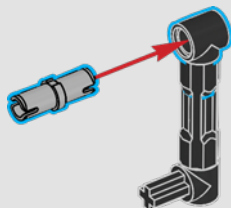

409

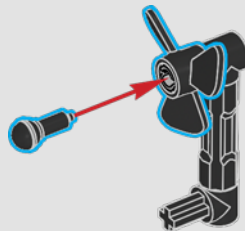

410



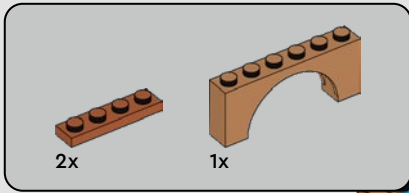

411

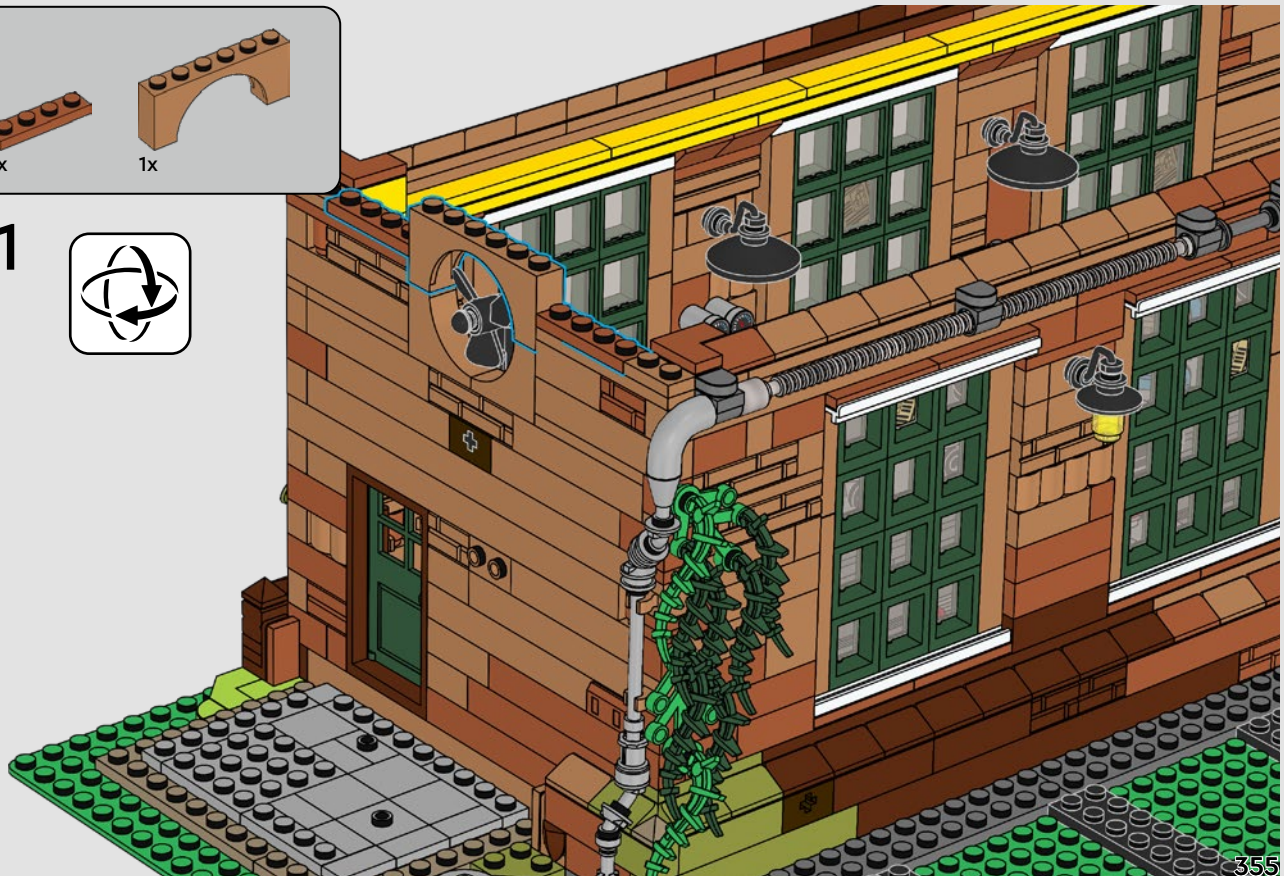



1x



1x

412



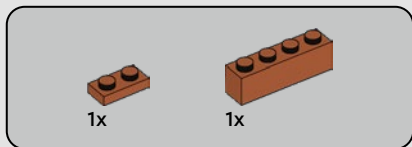

413



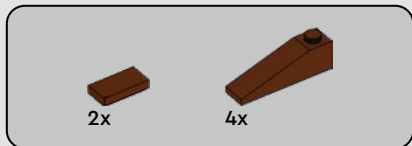

414





1x



1x

415

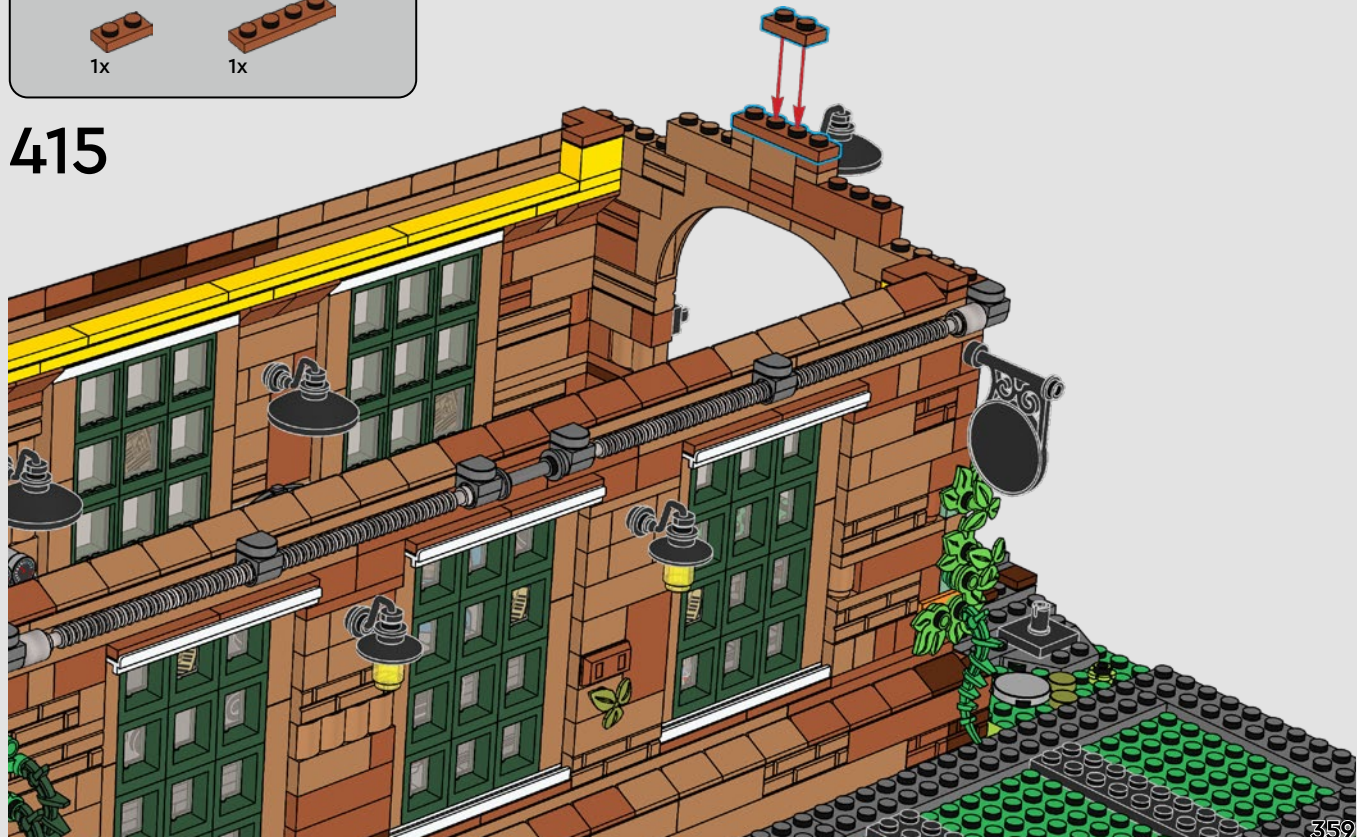

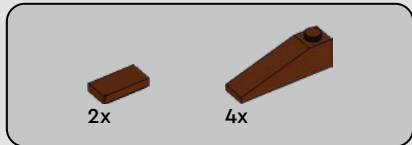

416



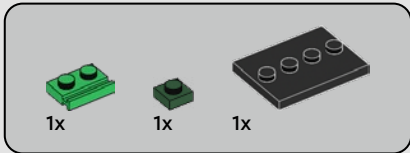
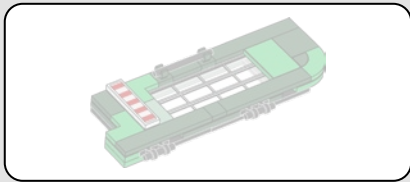

417

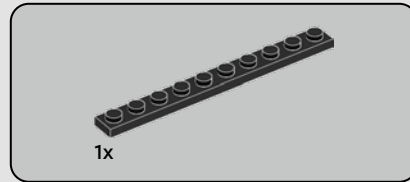
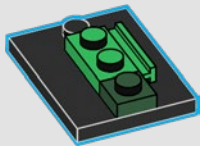

418

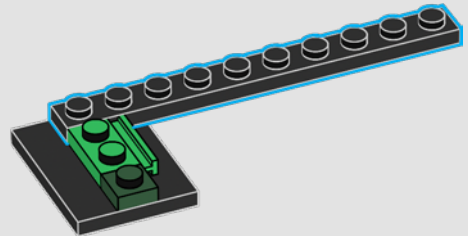

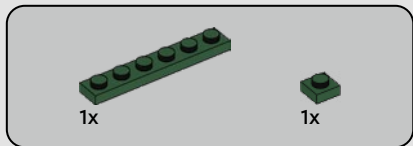

419

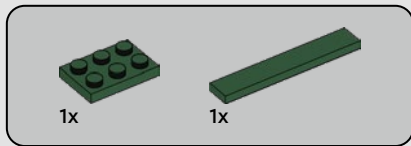
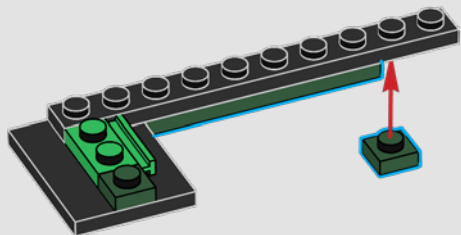

420

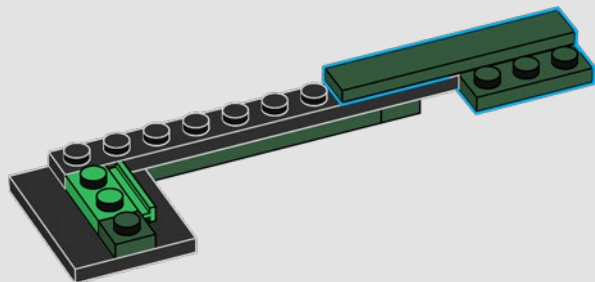

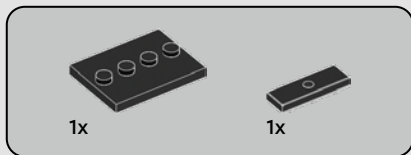

421

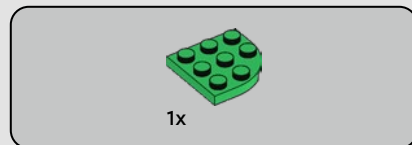
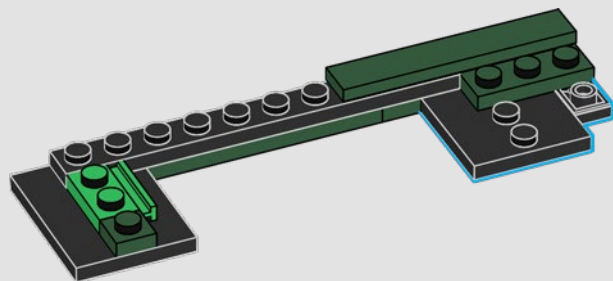

422

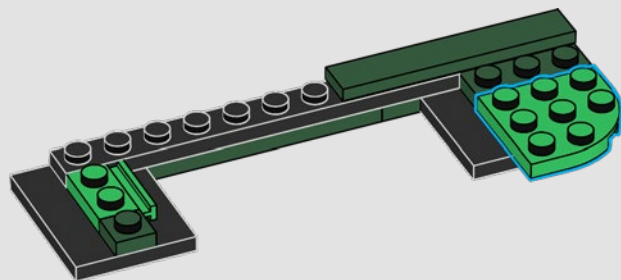



423

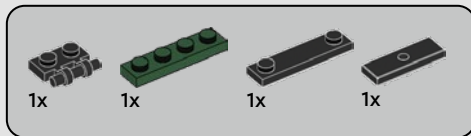
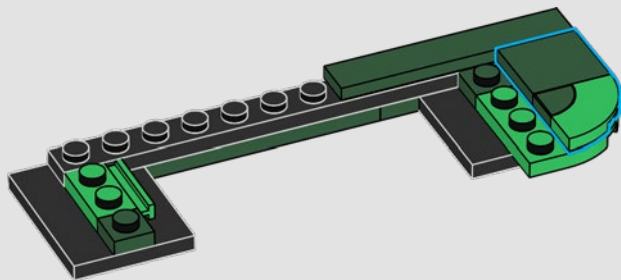

424

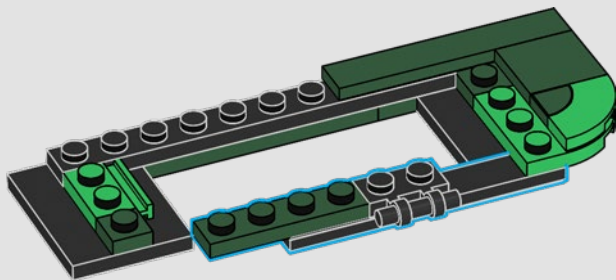

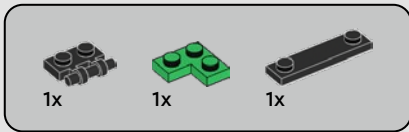

425

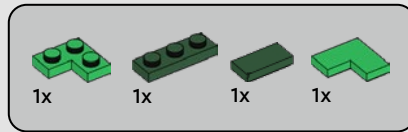
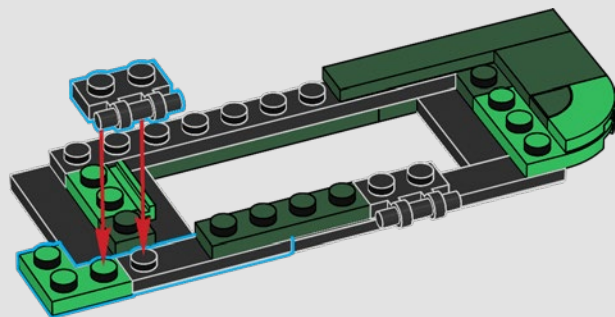

426

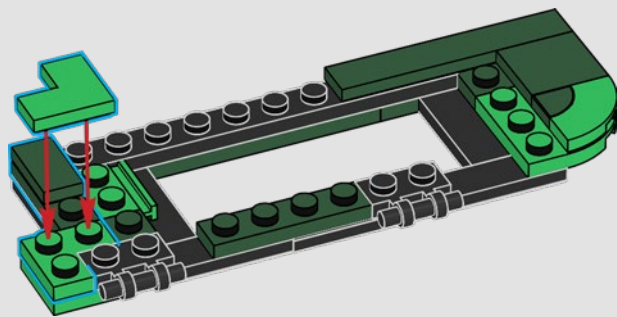



1x



1x



2x

427

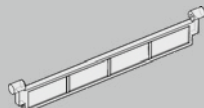
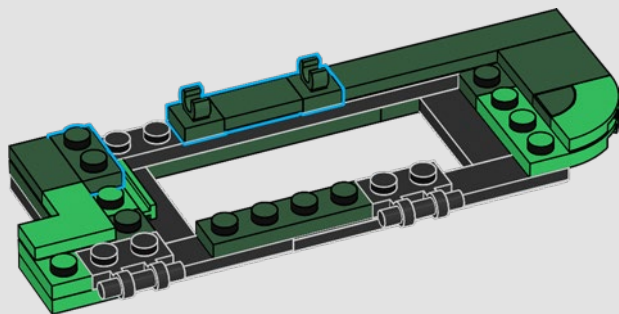

3x

428

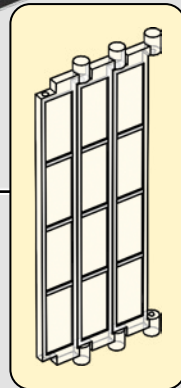
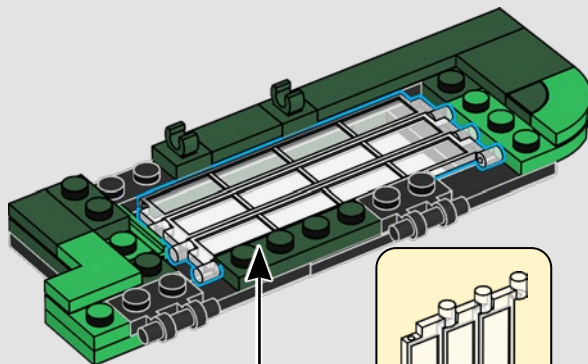

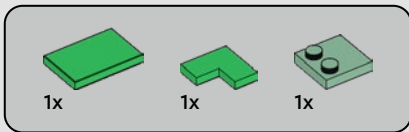

429

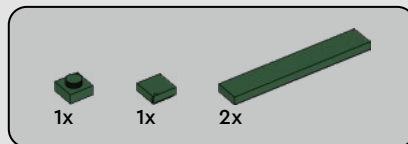
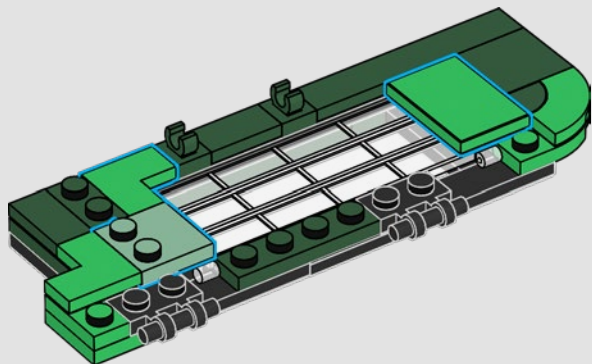

430

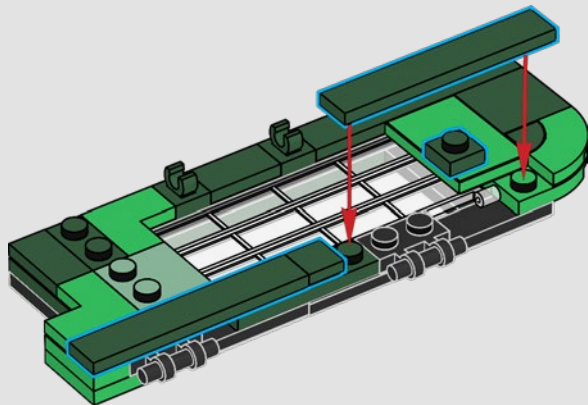

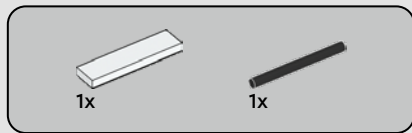

431

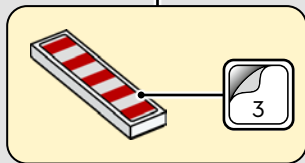
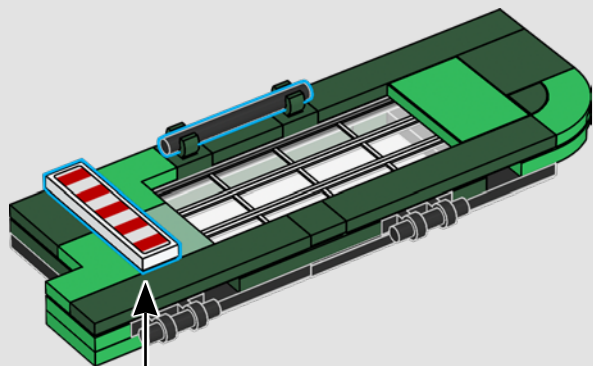

368

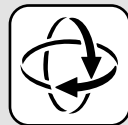

432

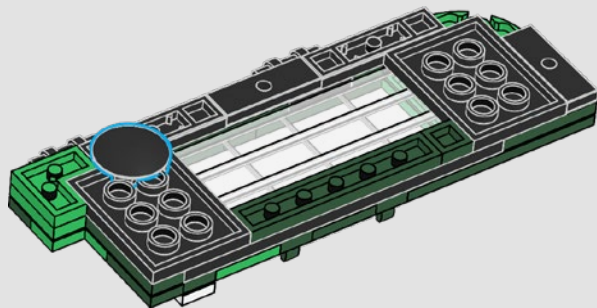

433



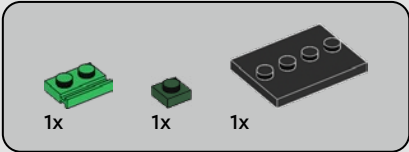
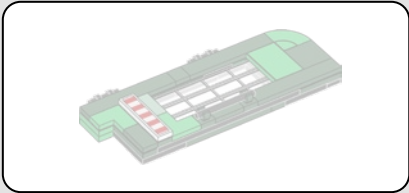

434

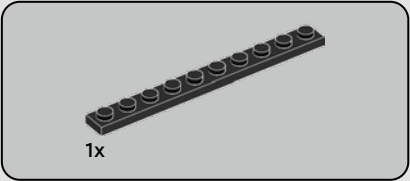
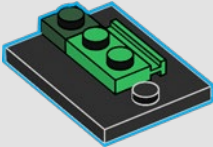

435

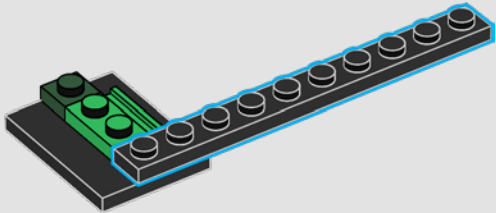

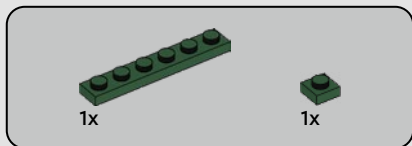

436

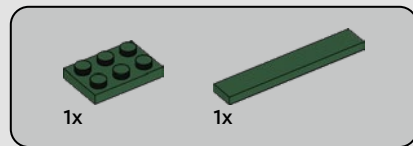
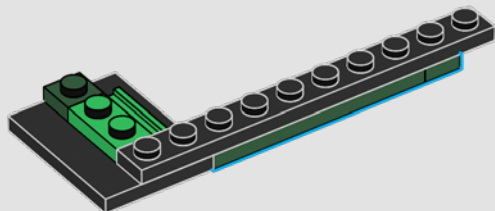

437

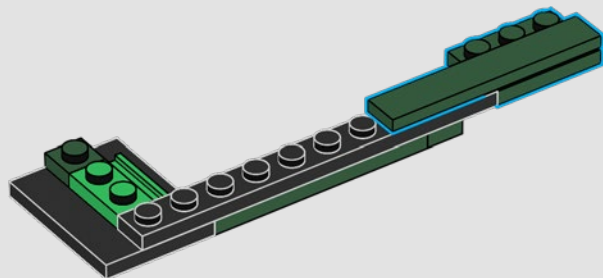

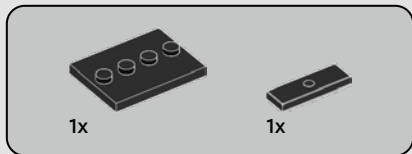

438

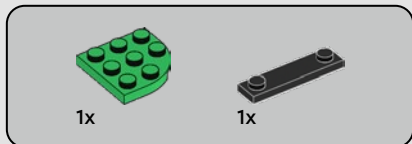
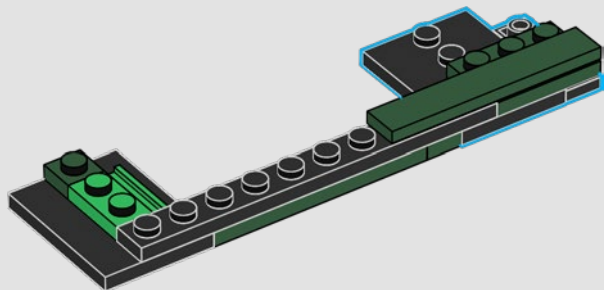

439

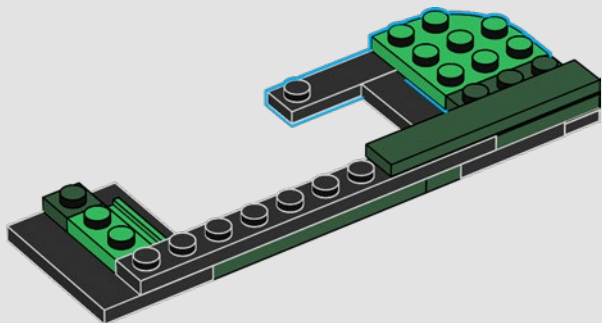

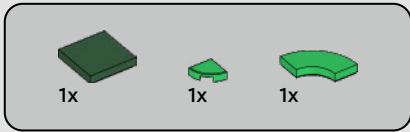

440

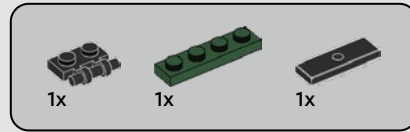
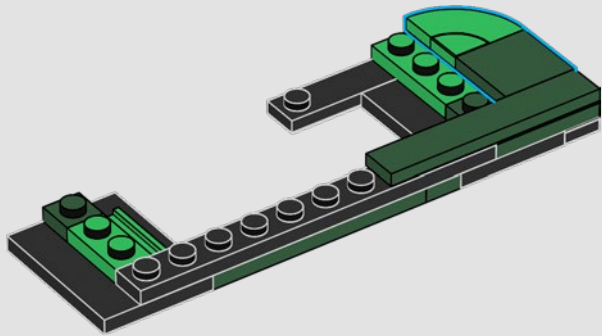

441

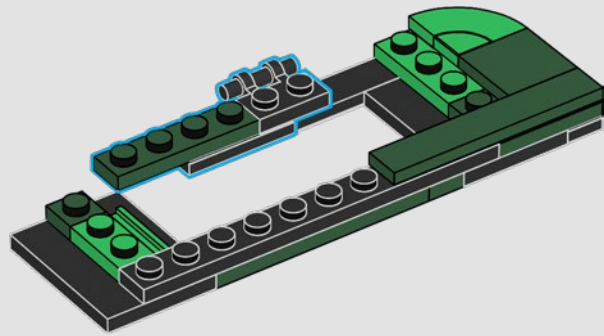

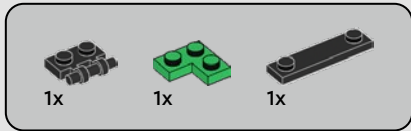

442

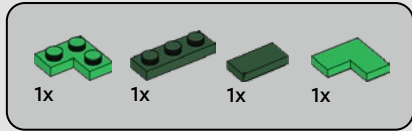
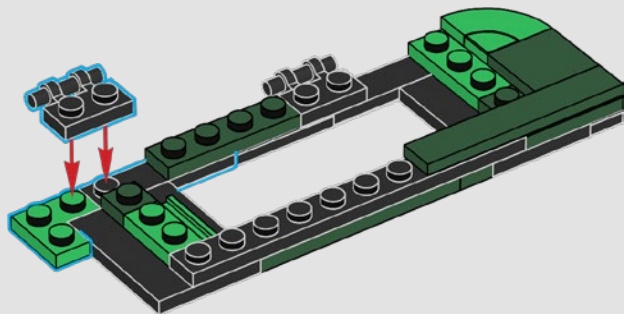

443

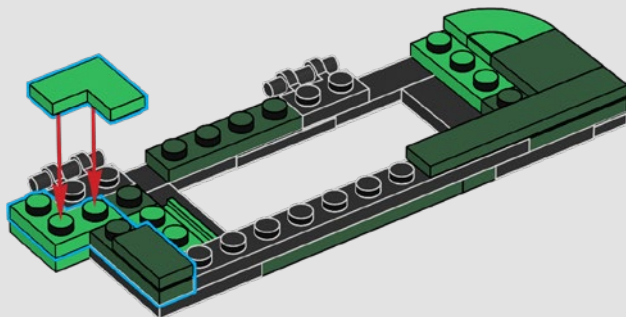

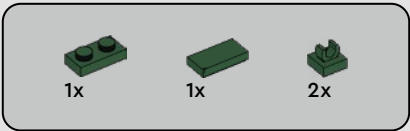

444

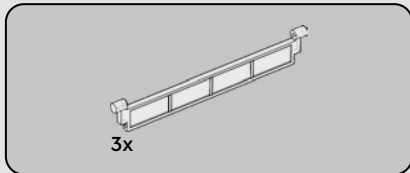
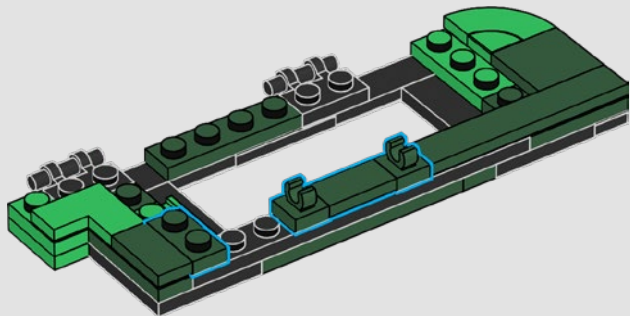

445

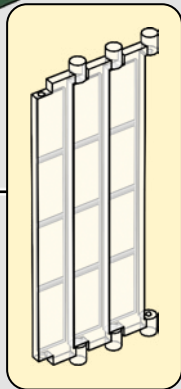
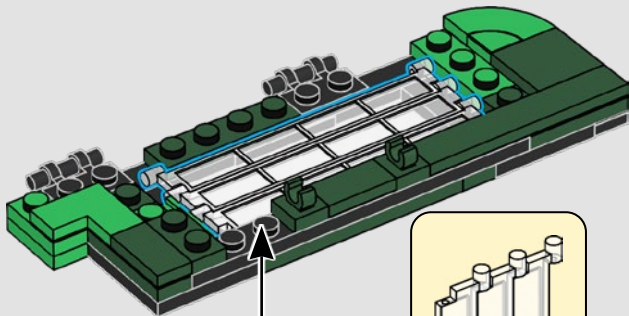

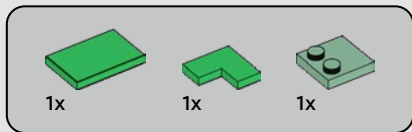

446

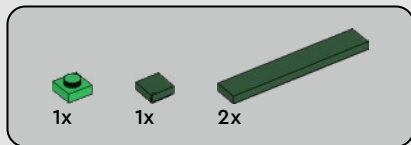
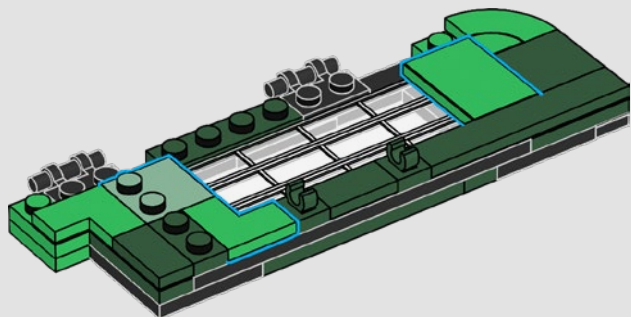

447

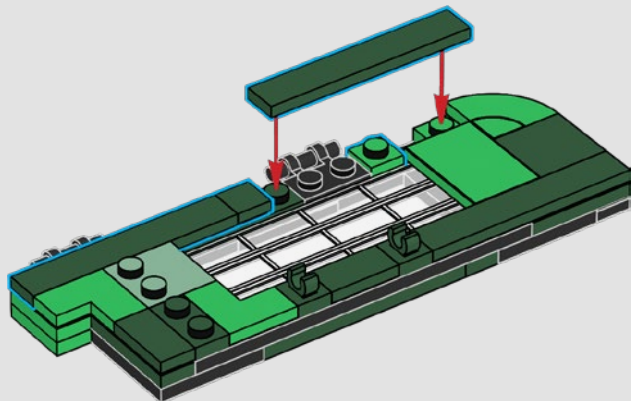

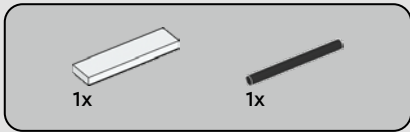

448

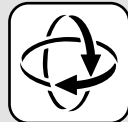
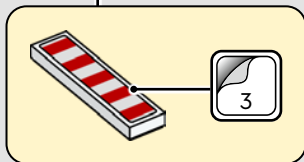
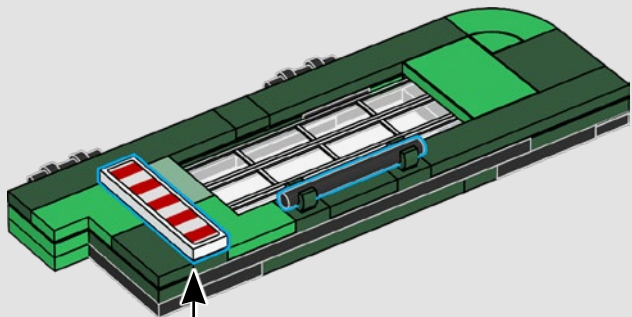

449

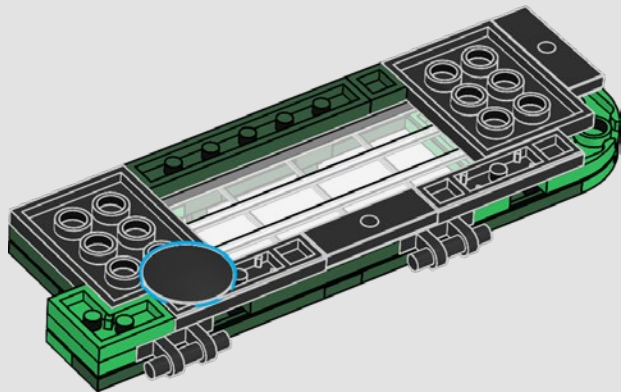

450



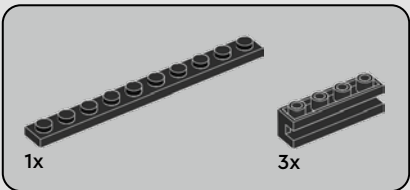
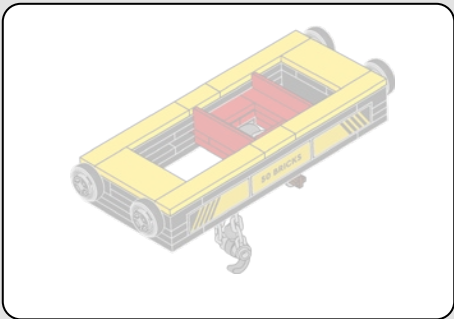

451

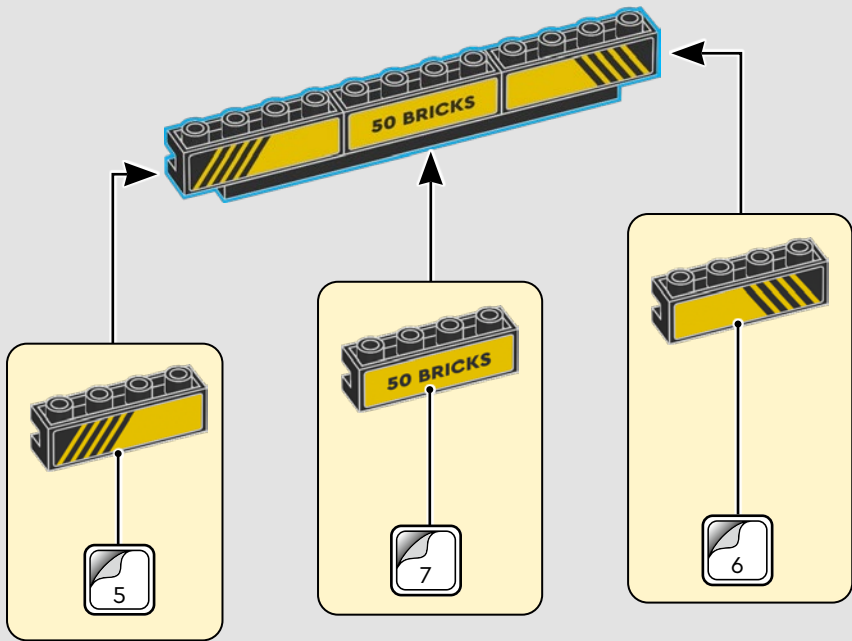

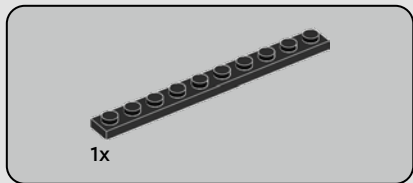

452

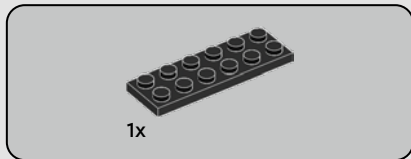
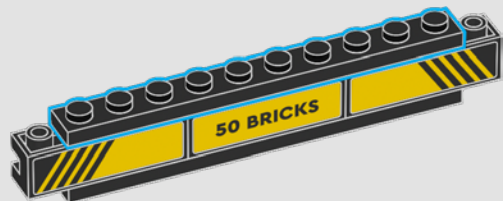

453

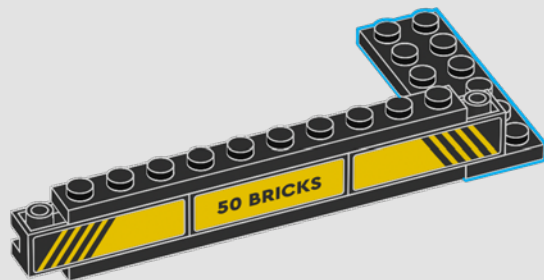

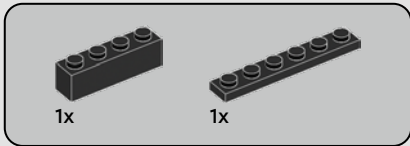

454

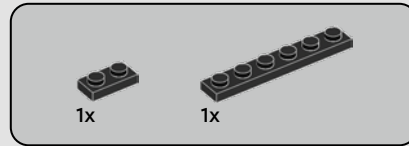
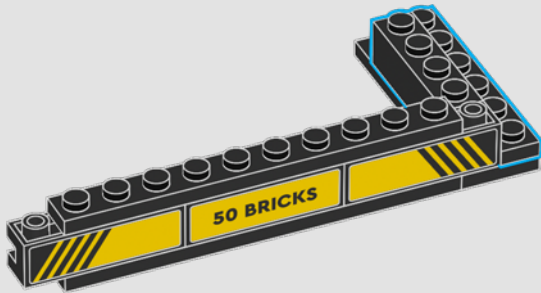

455

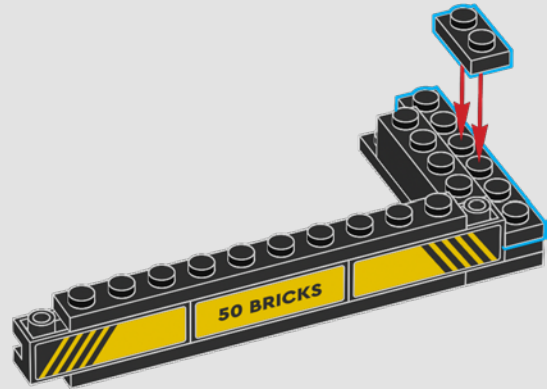

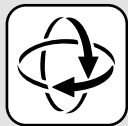
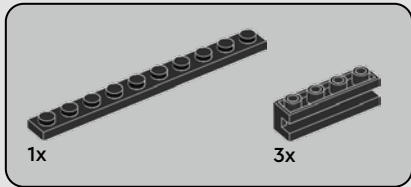

456

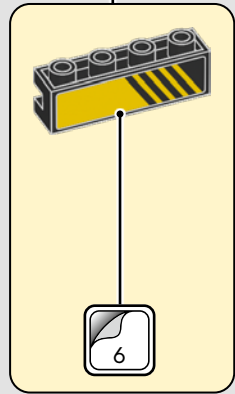
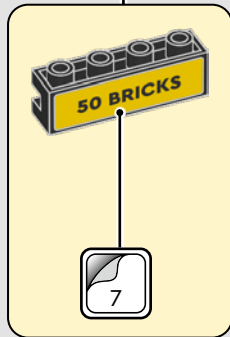
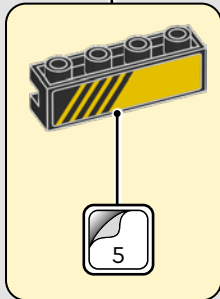
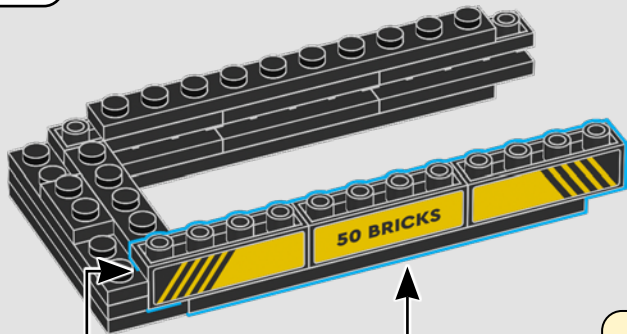

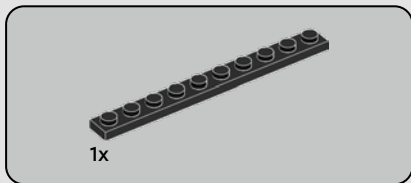

457

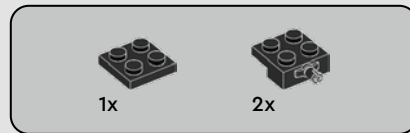
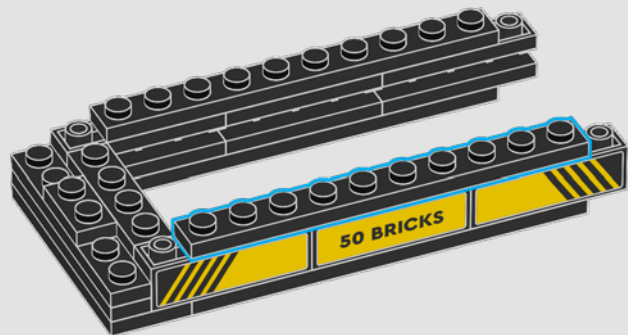

458

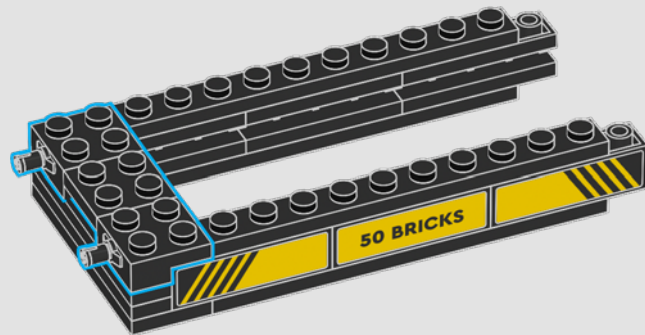

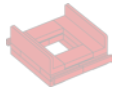

1x



2x

459

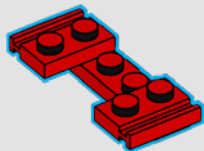

2x

460

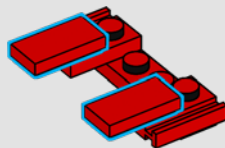

2x

461

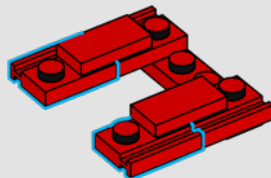



1x

462

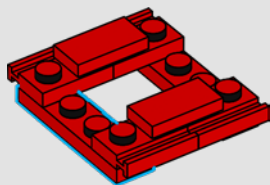

2x

463

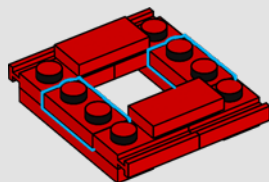

2x

464

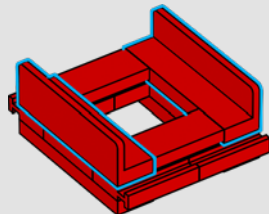

465

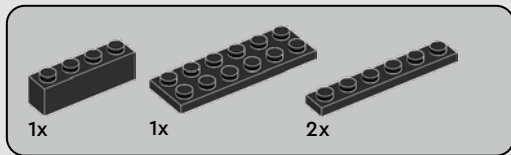
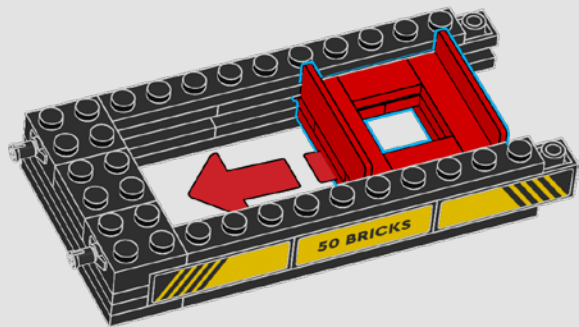

466

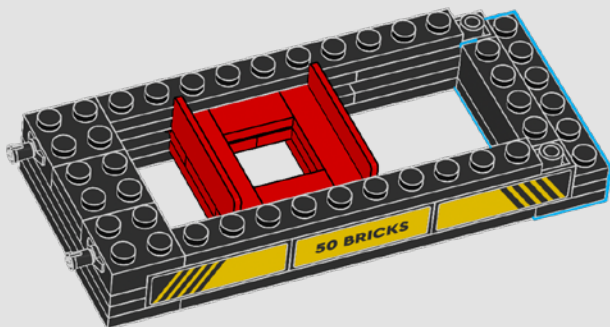

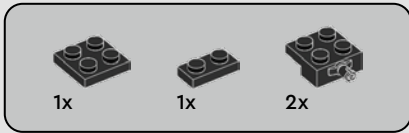

467

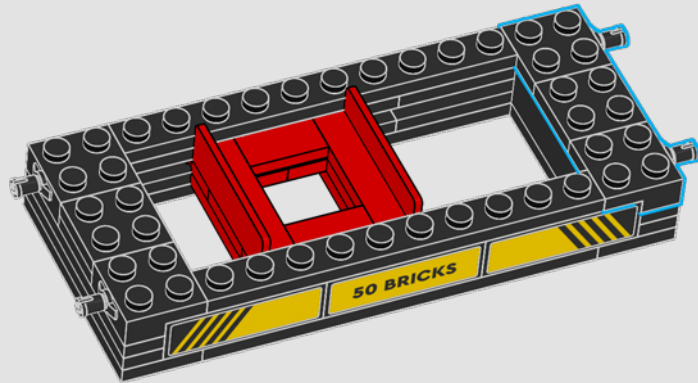

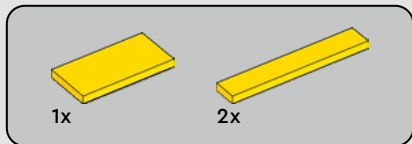

468

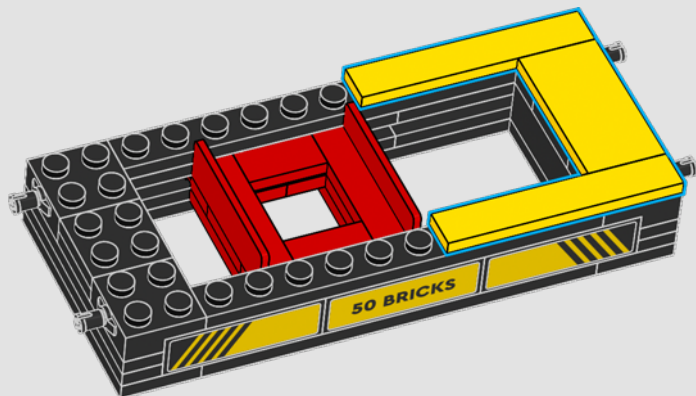



2x

469

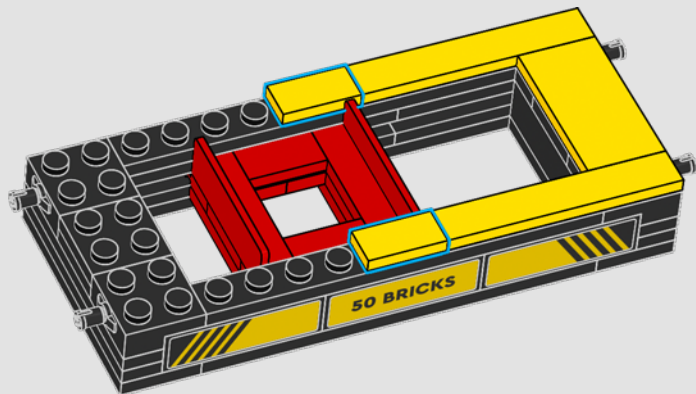

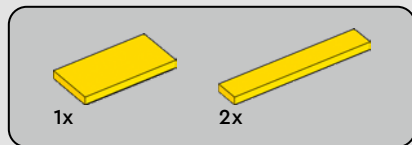

470

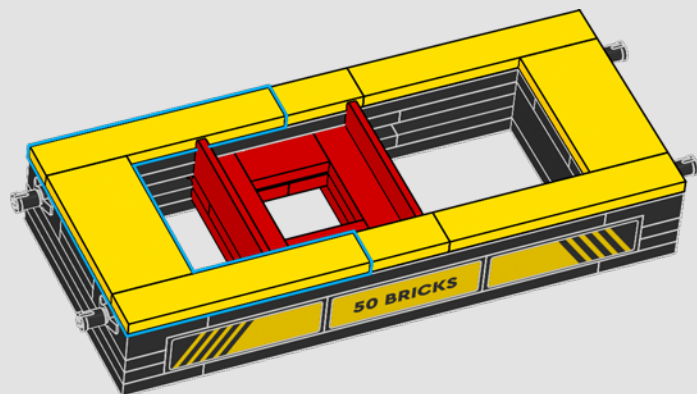



4x



4x

471

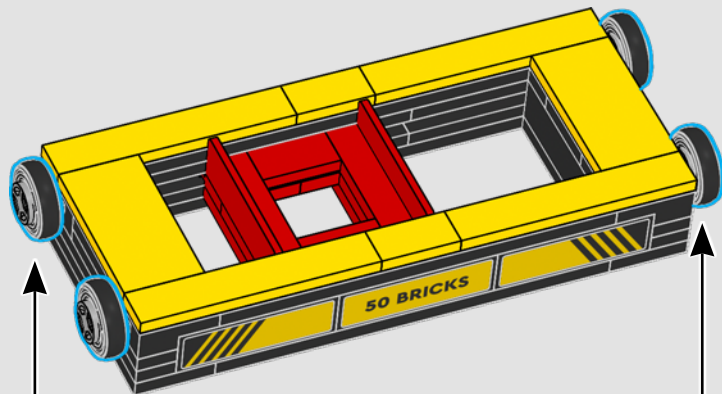

4x



2x

472

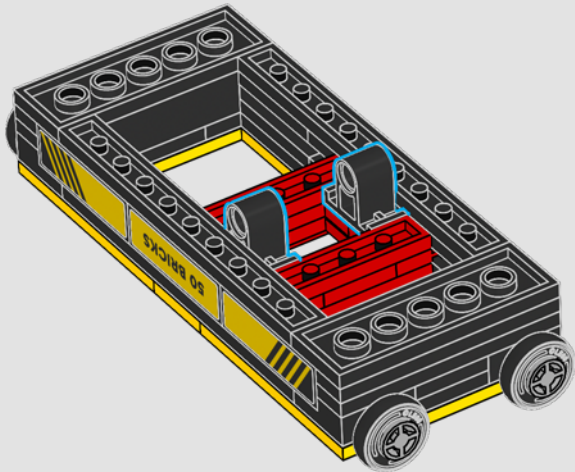

1x



1x

5

473

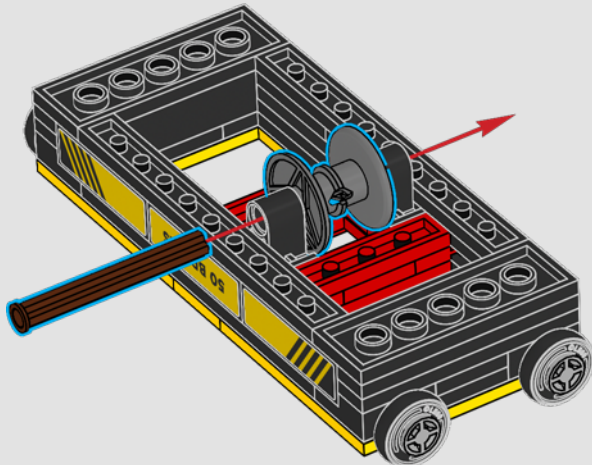

5

1:1

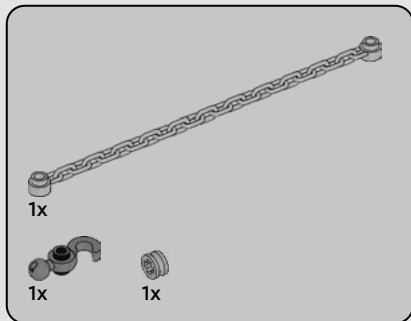

474

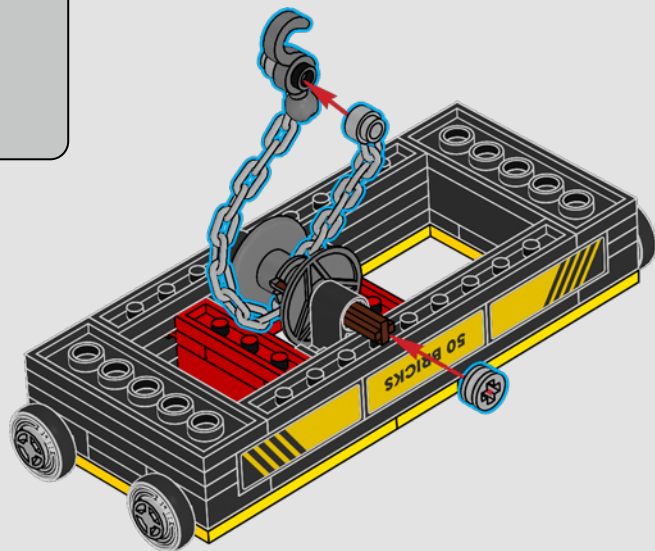

475



394

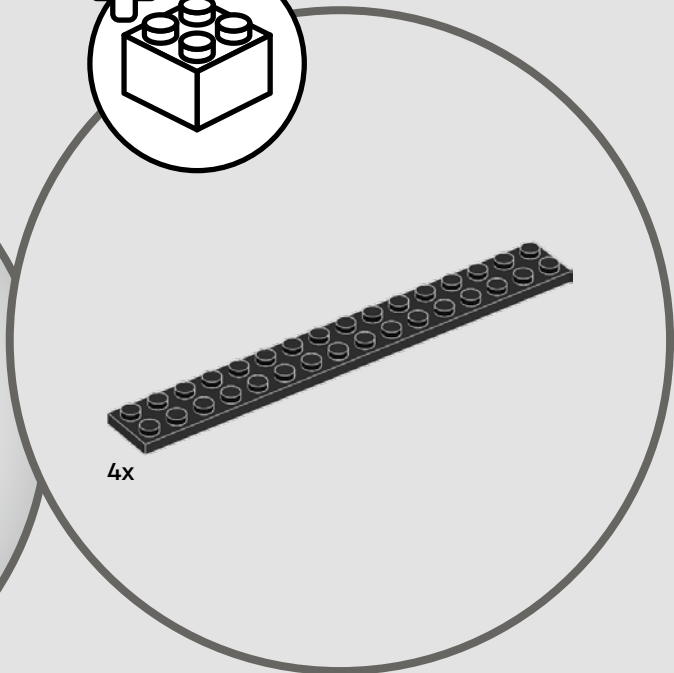
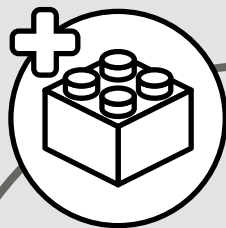
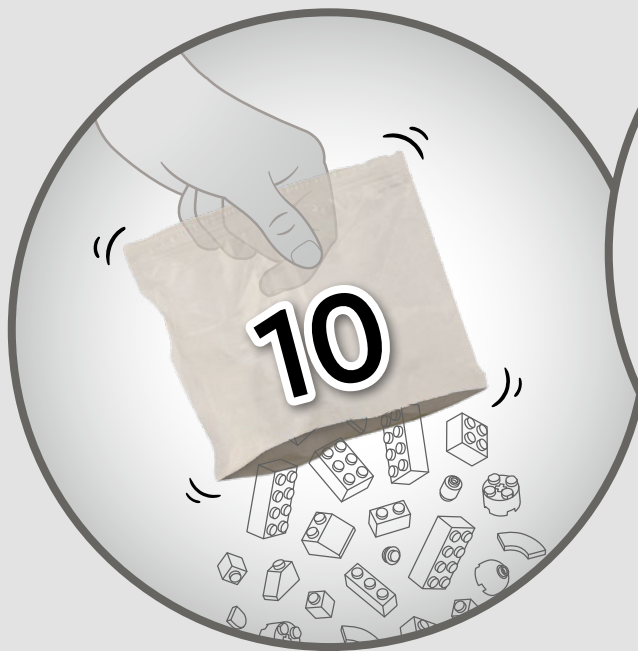

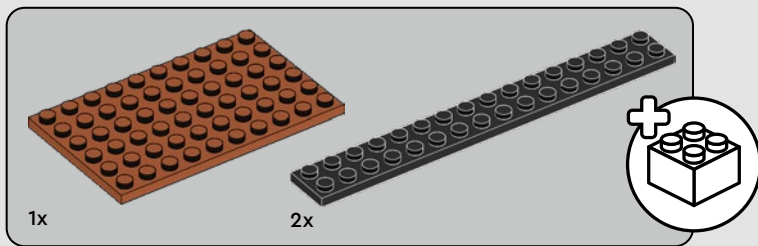
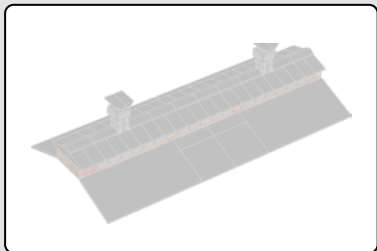

476

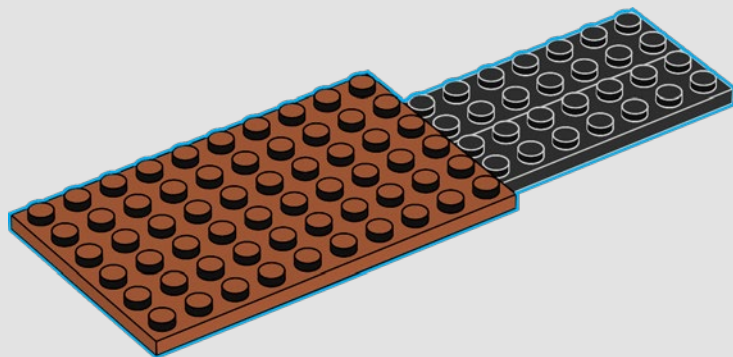

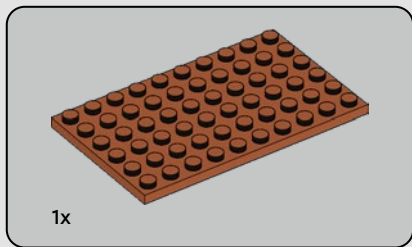

477

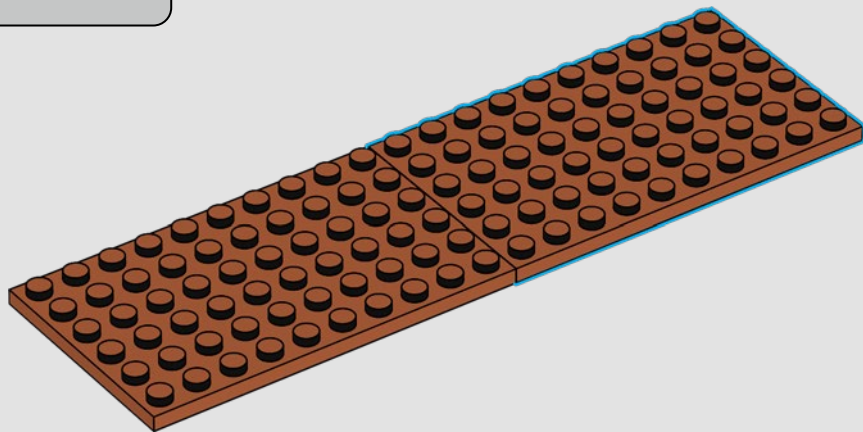

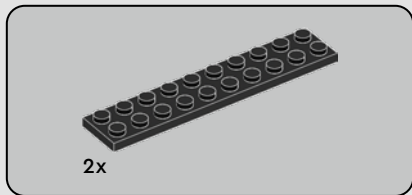

478

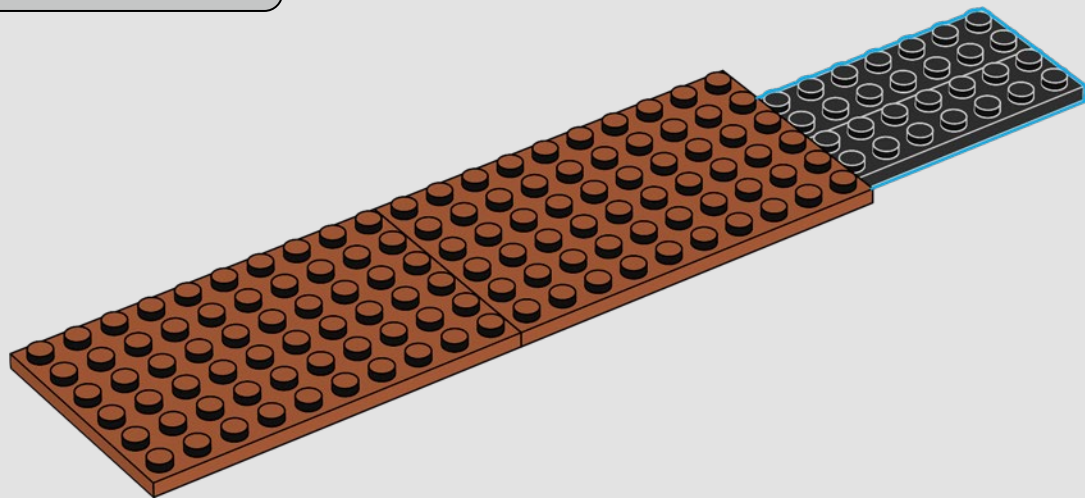

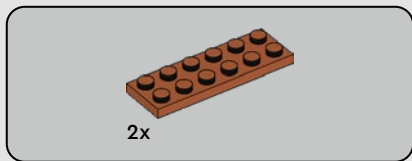

479

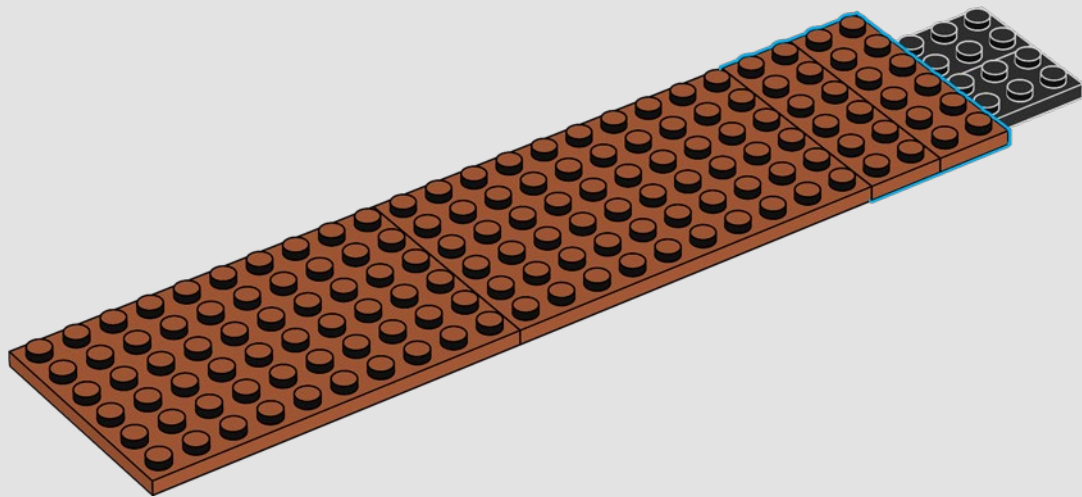

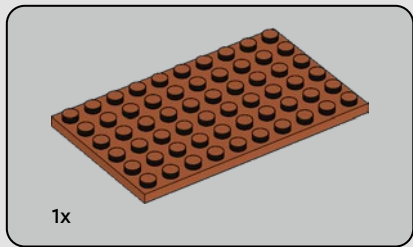

1x

480

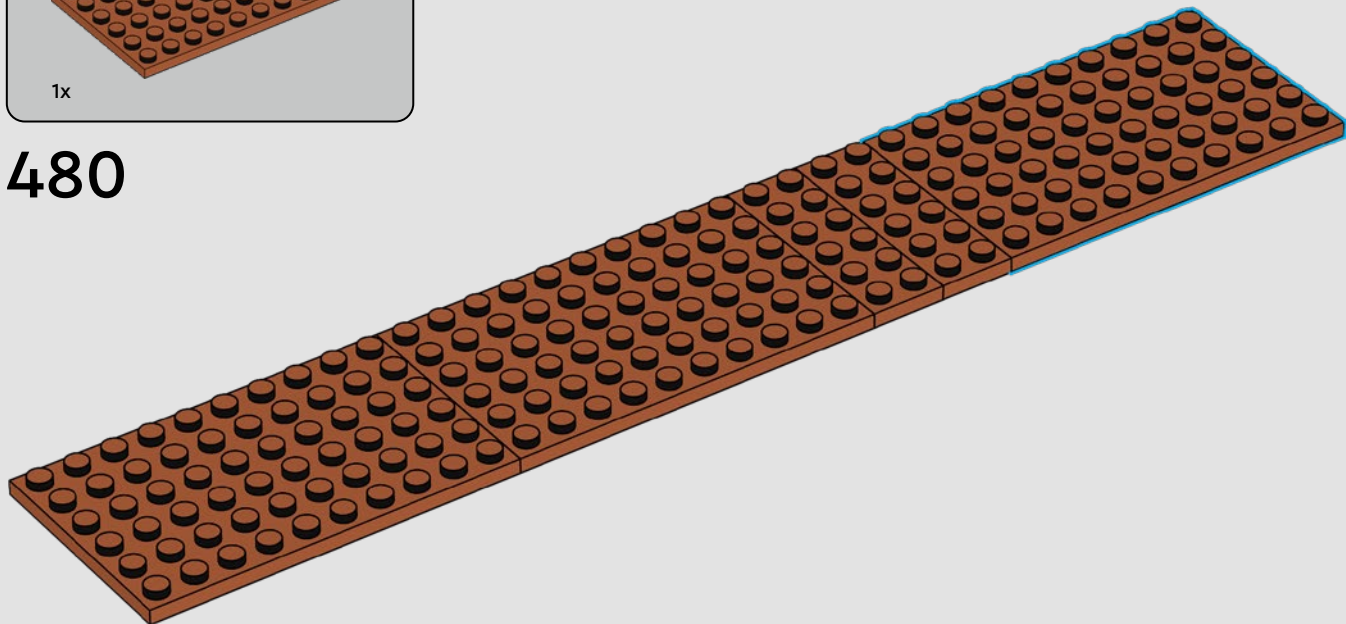

400

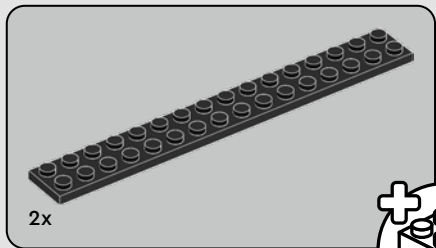

481

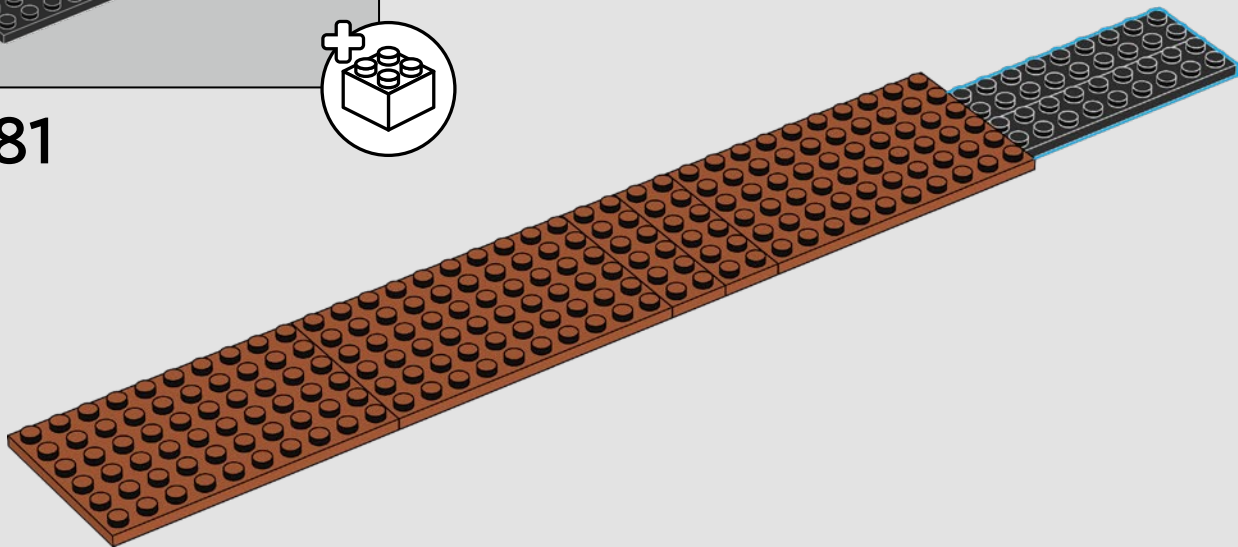

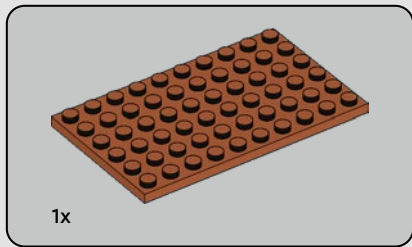

482

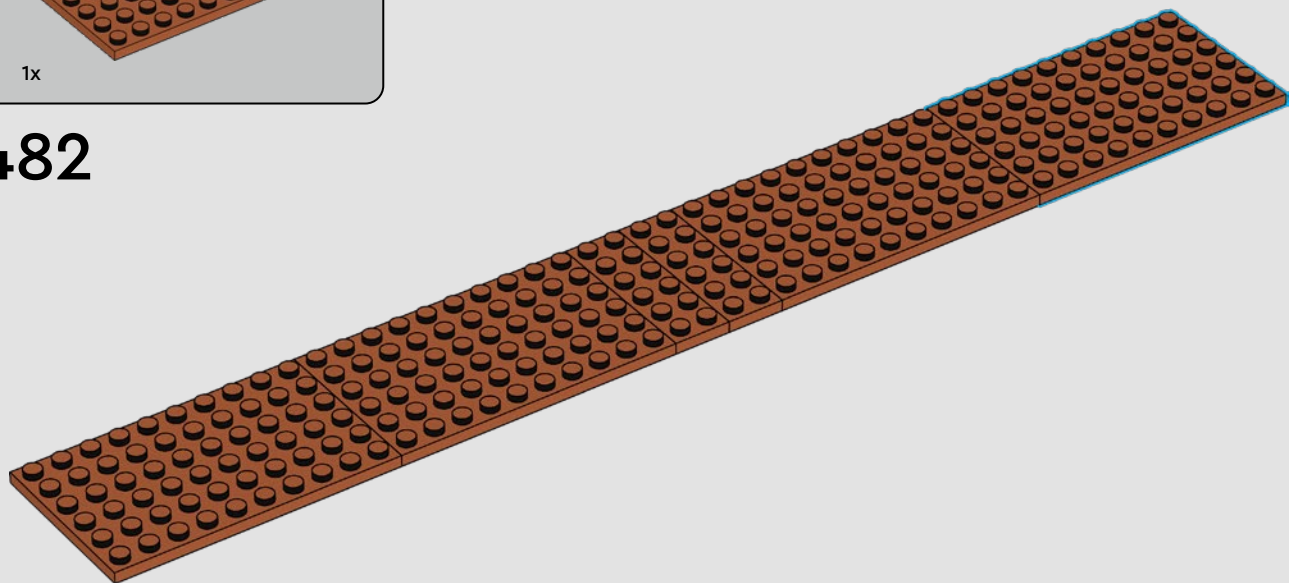

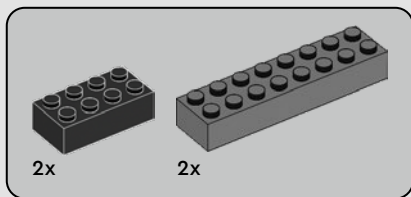

483

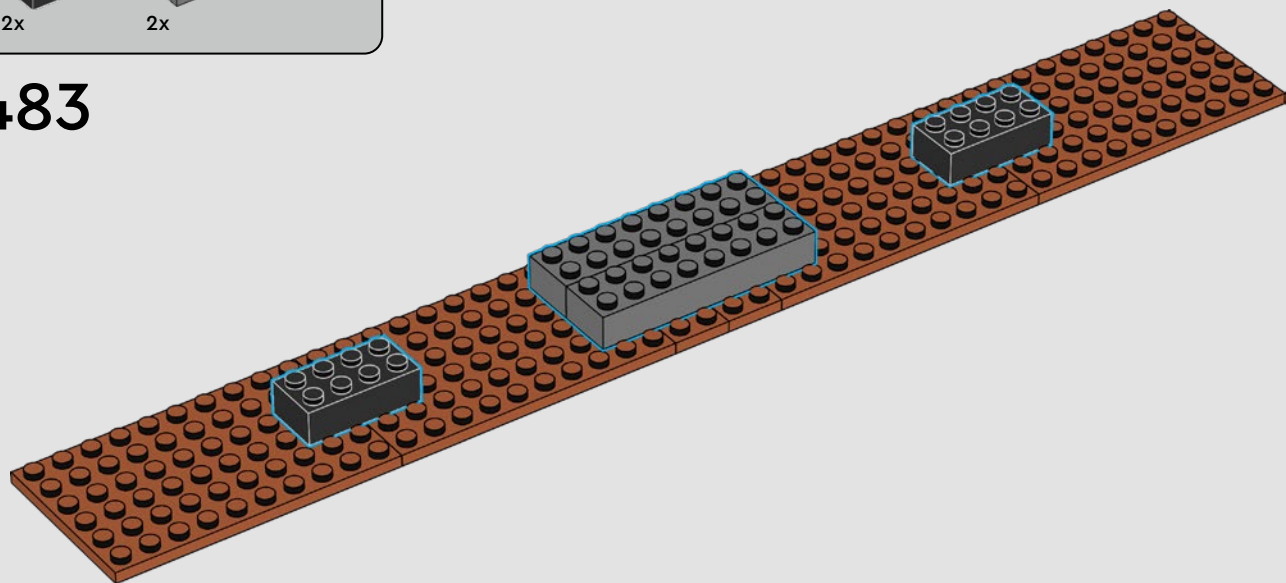

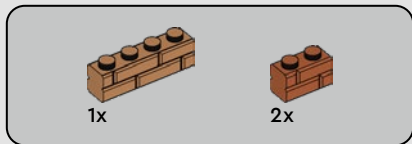

484

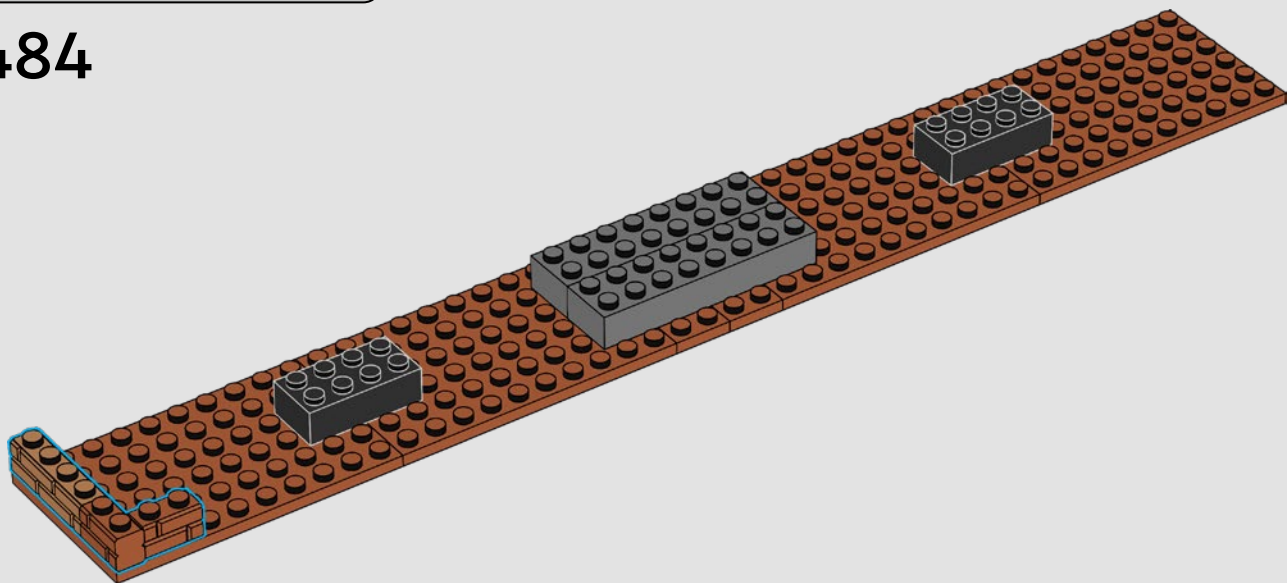



10x

485

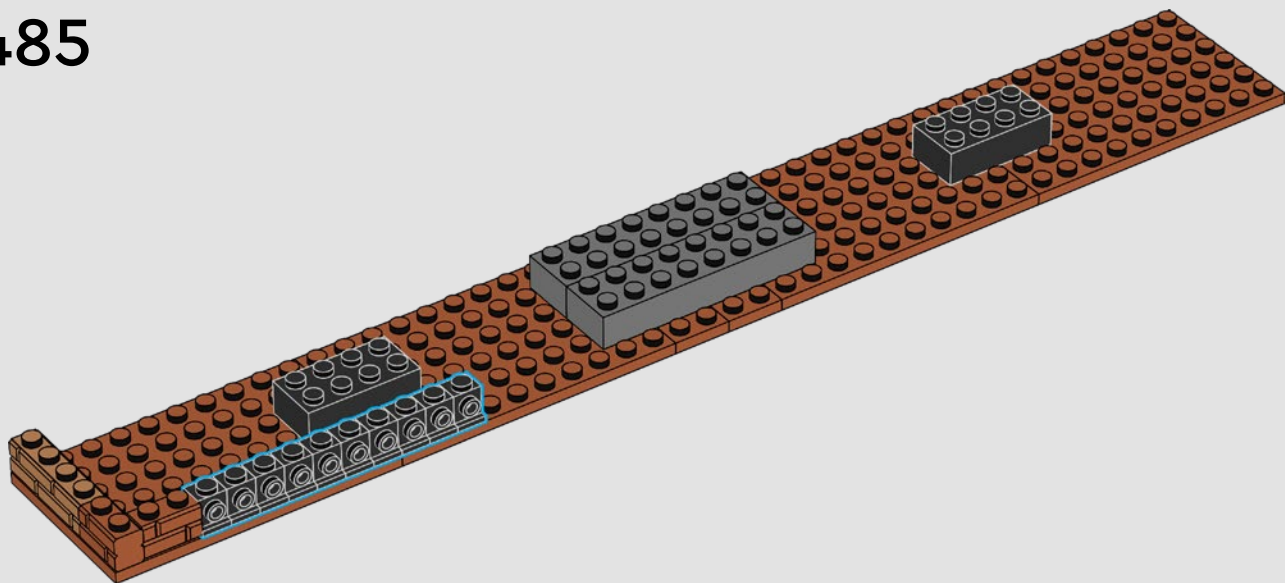



5x

486

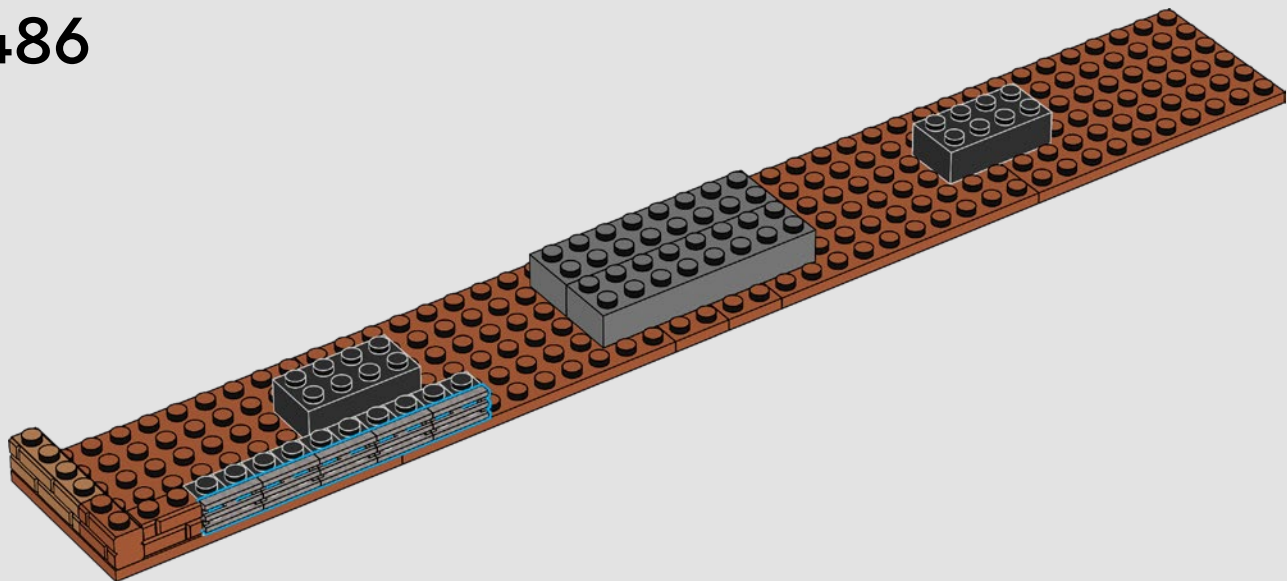

406



9x



1x

489

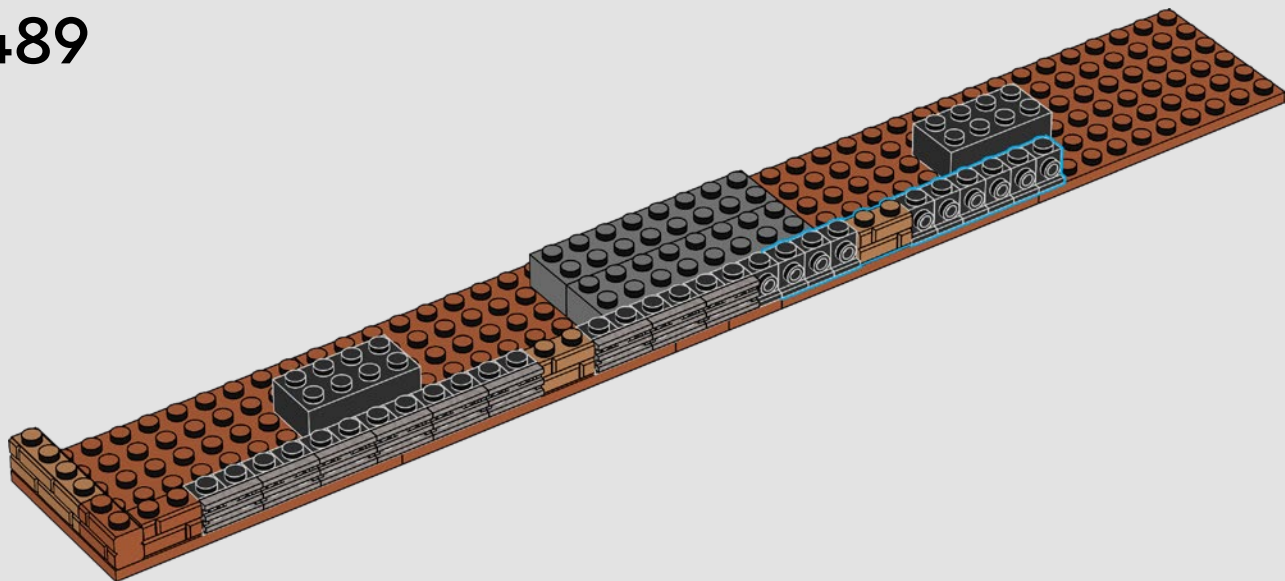



6x



1x

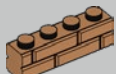

1x

491

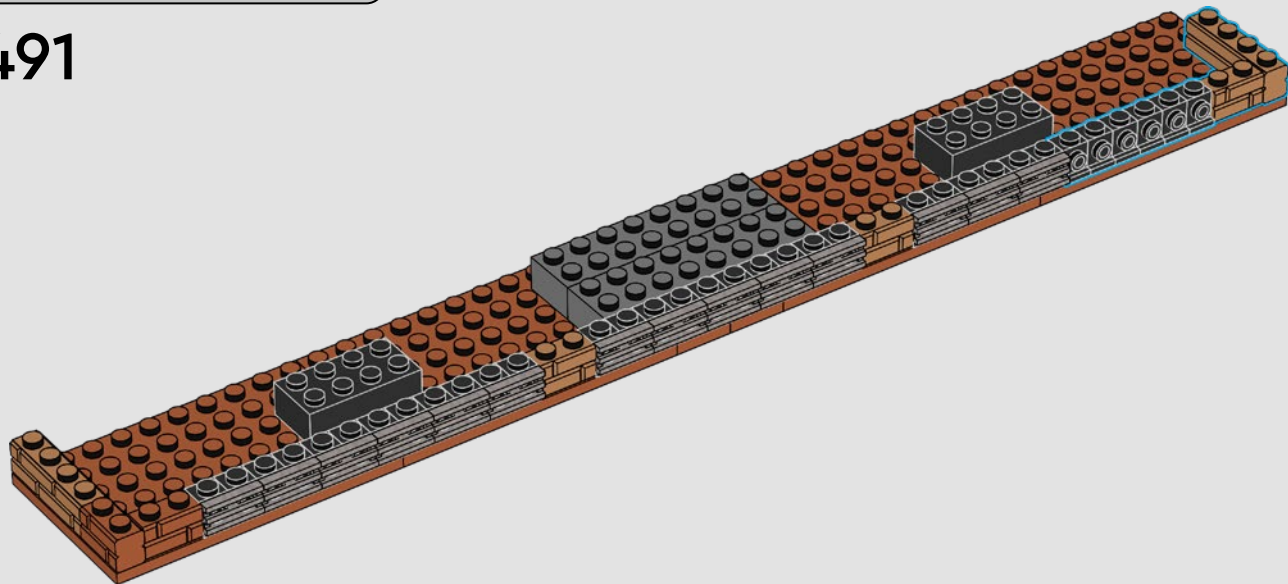



3x



2x

492

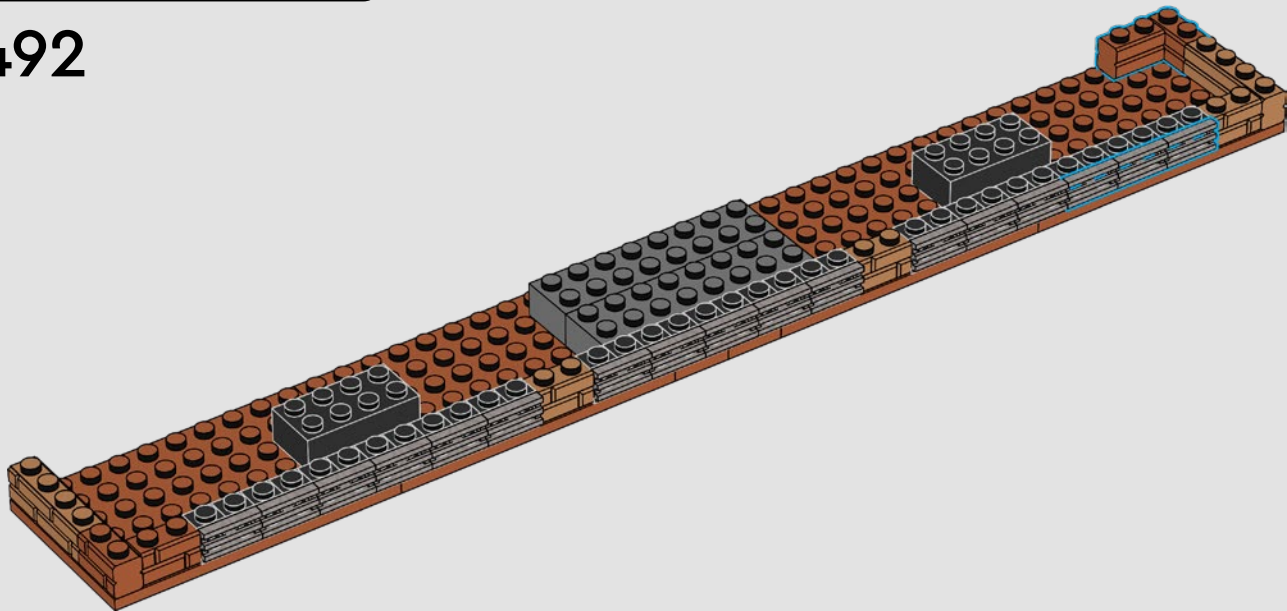



10x

493

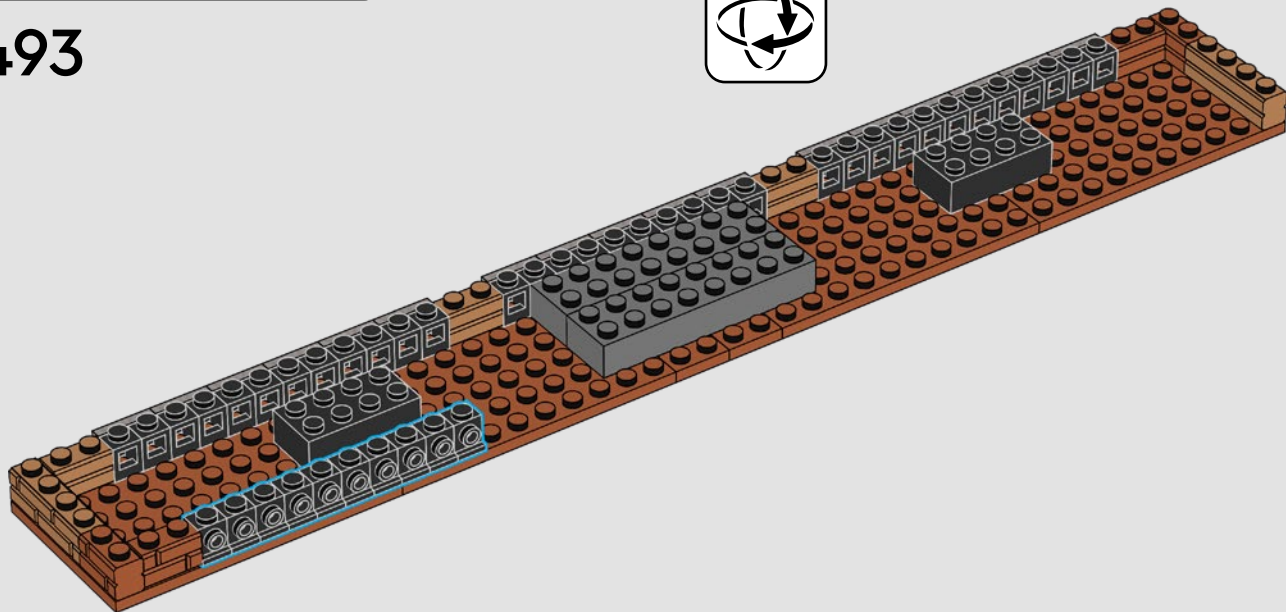



5x

494

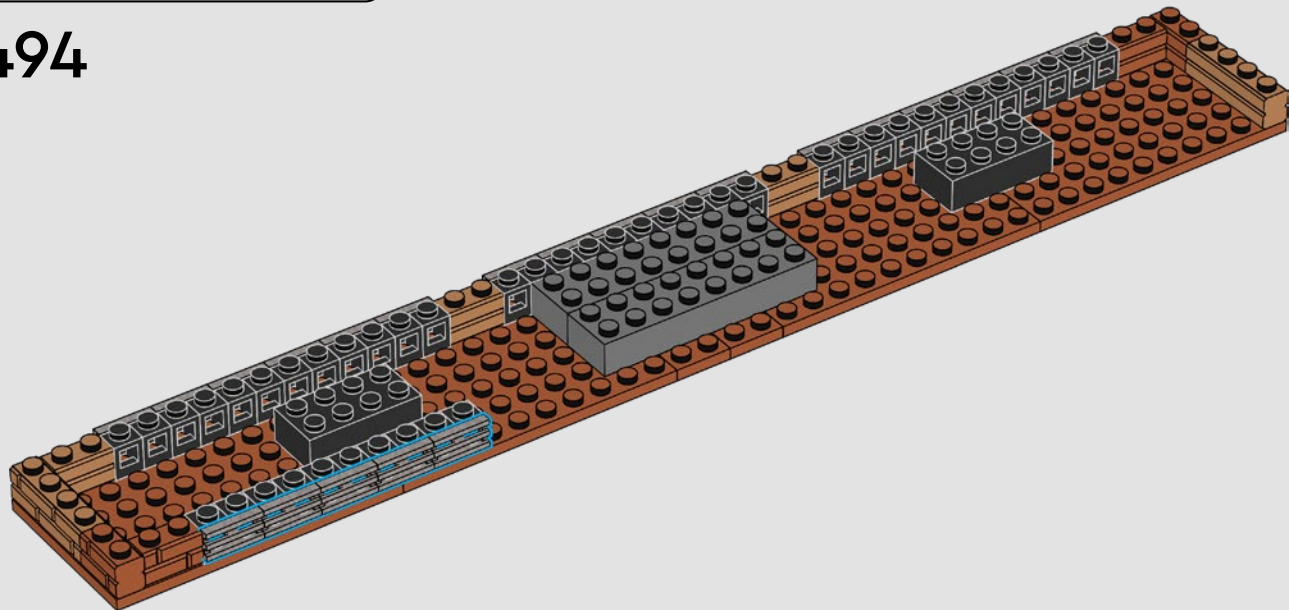



9x



1x

495

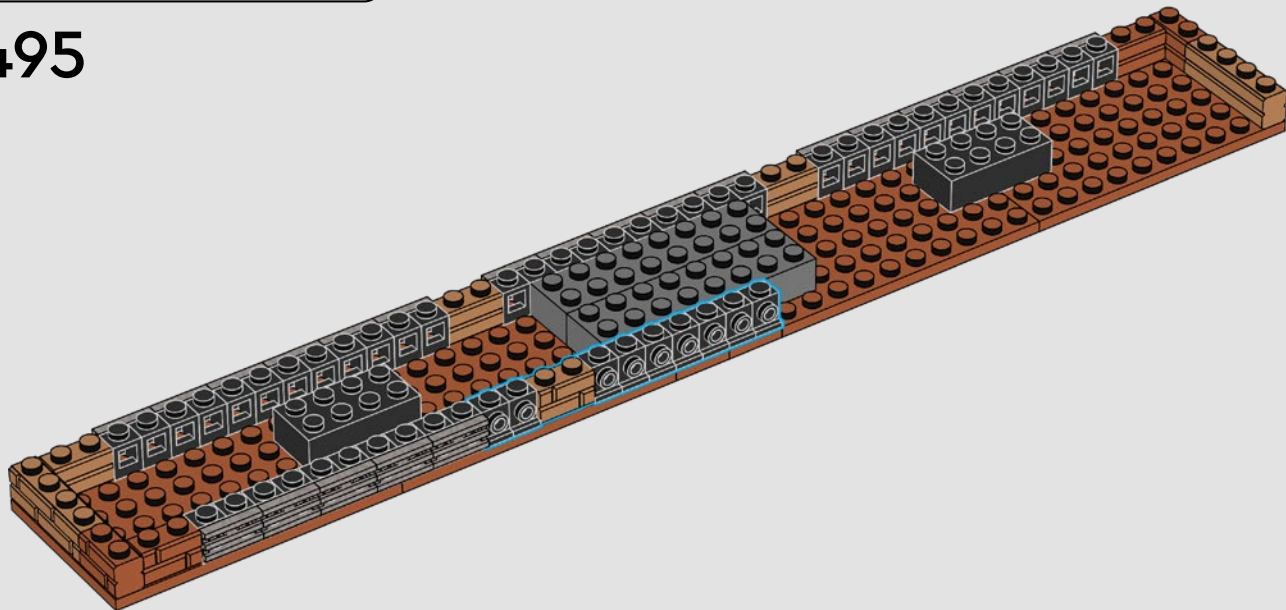



4x

496

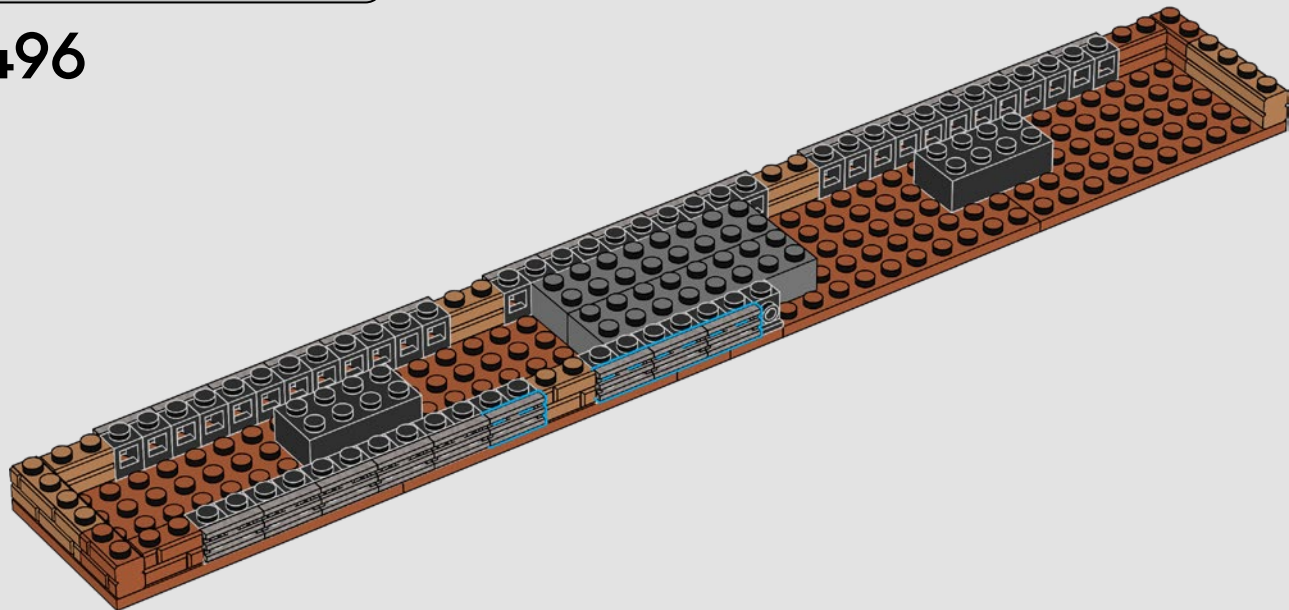



9x

497

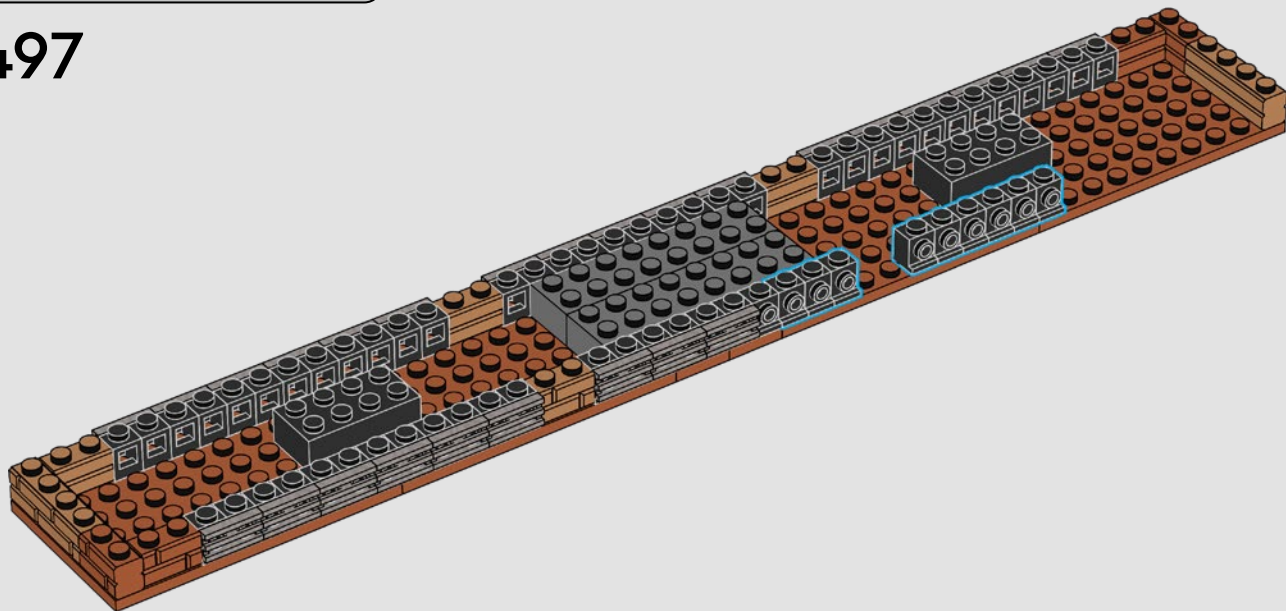



5x



1x

498

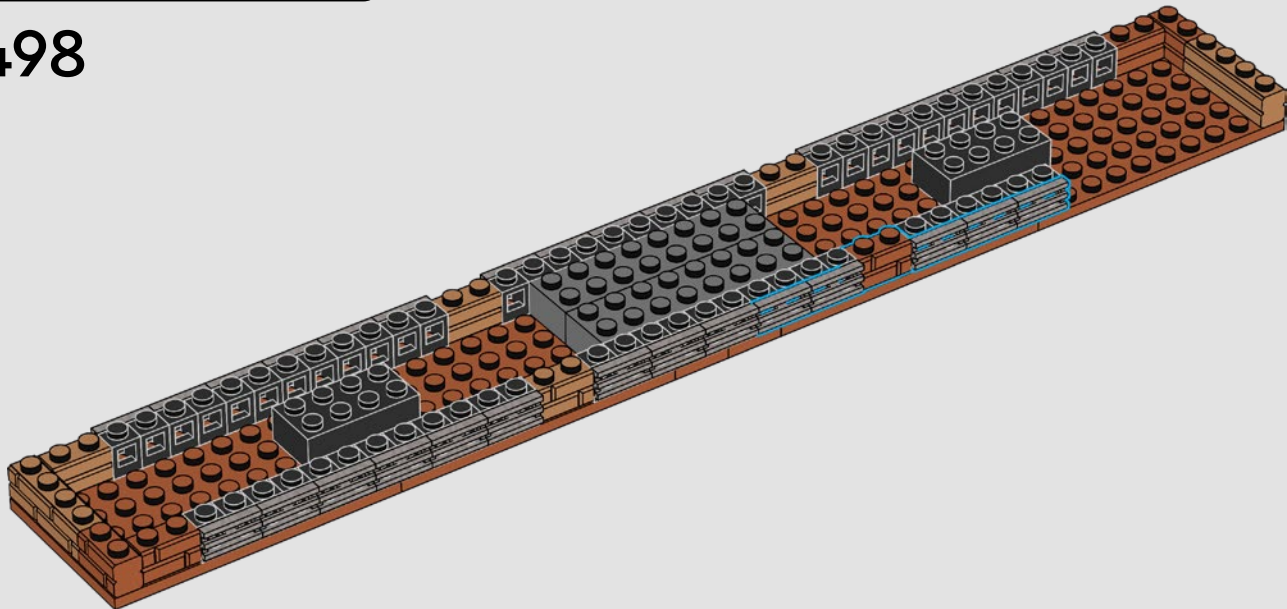



6x



1x



3x

499

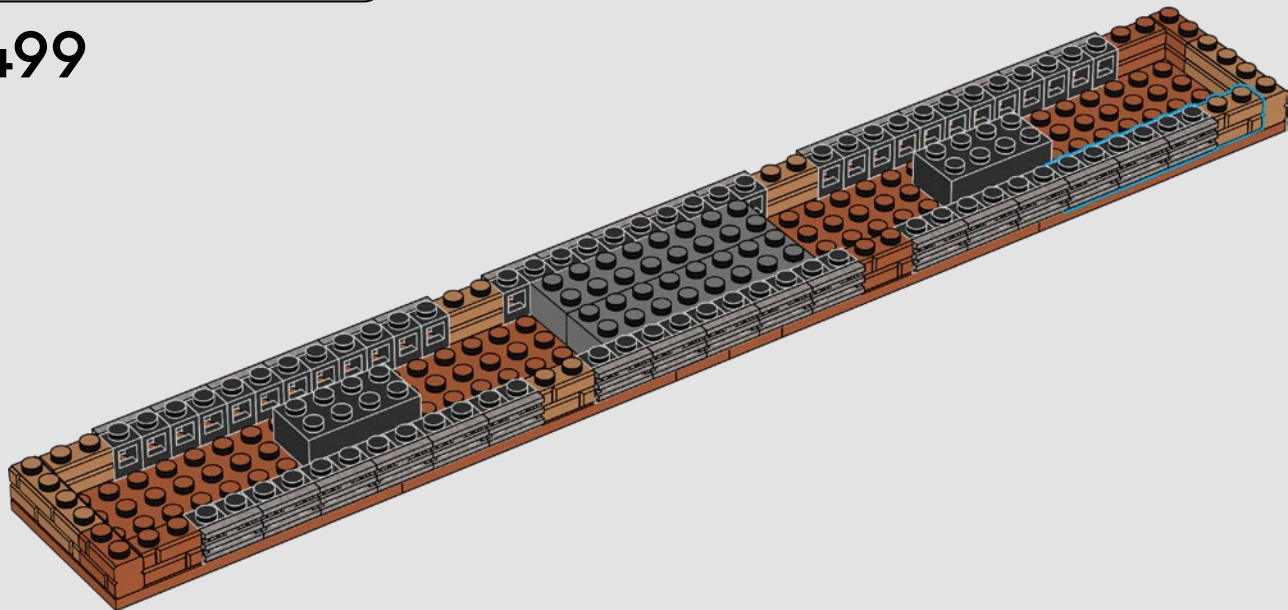

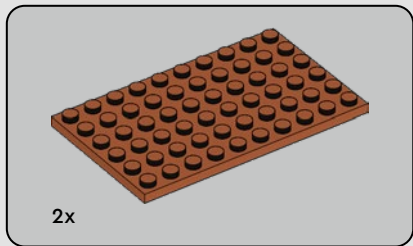

500

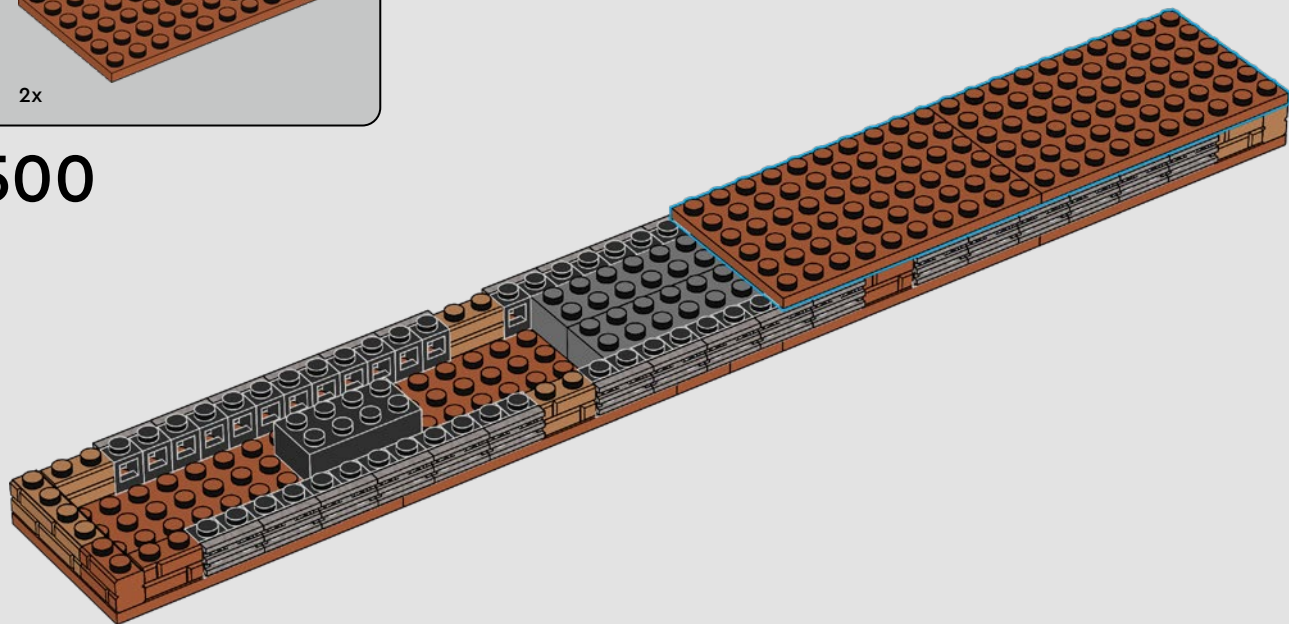

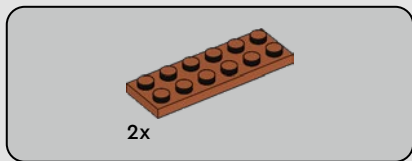

501

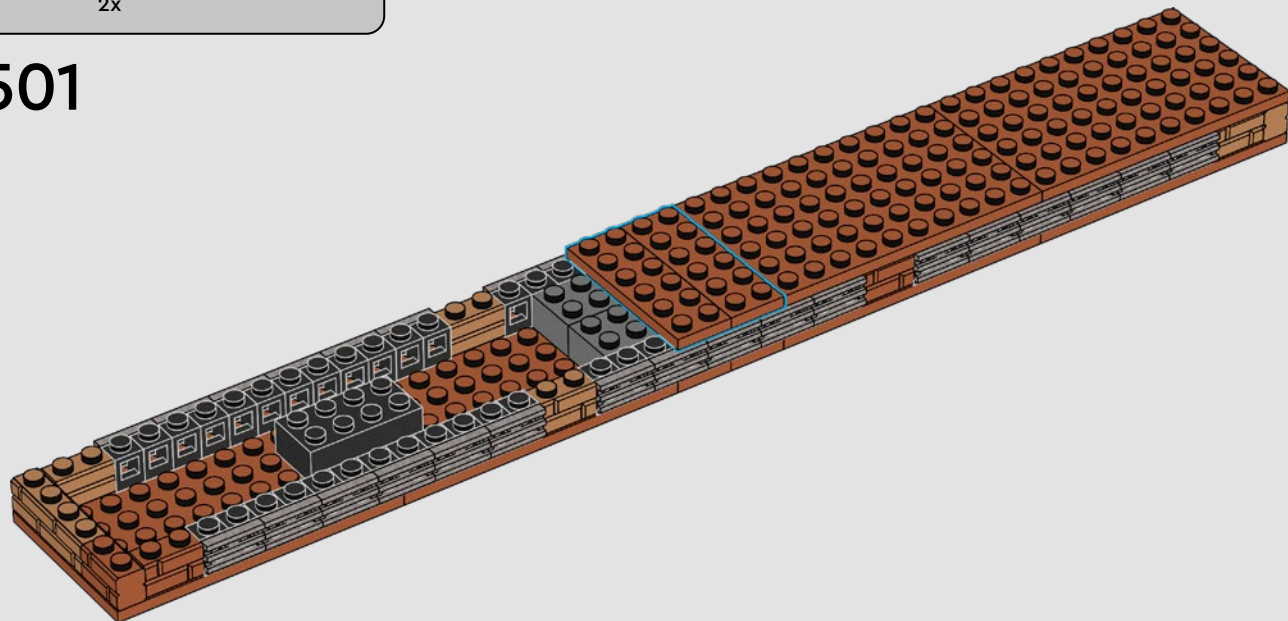

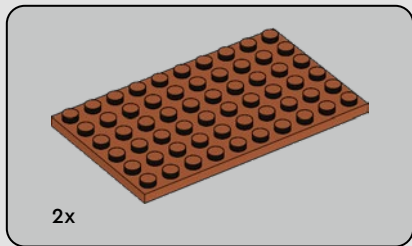

502

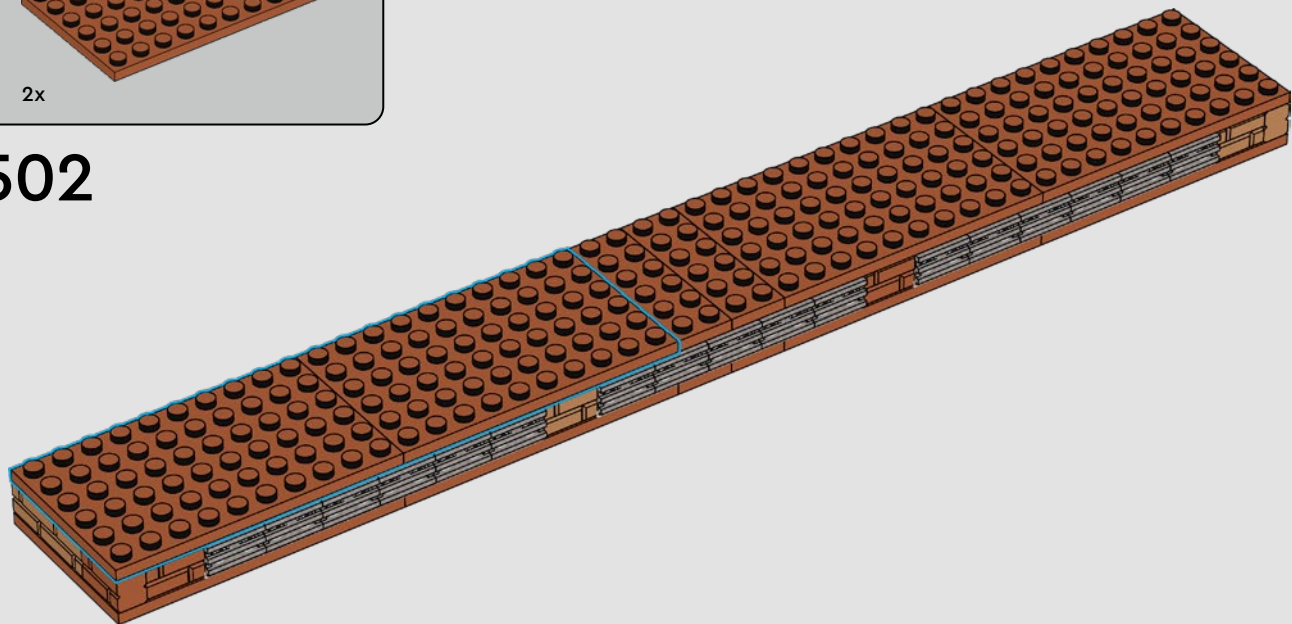

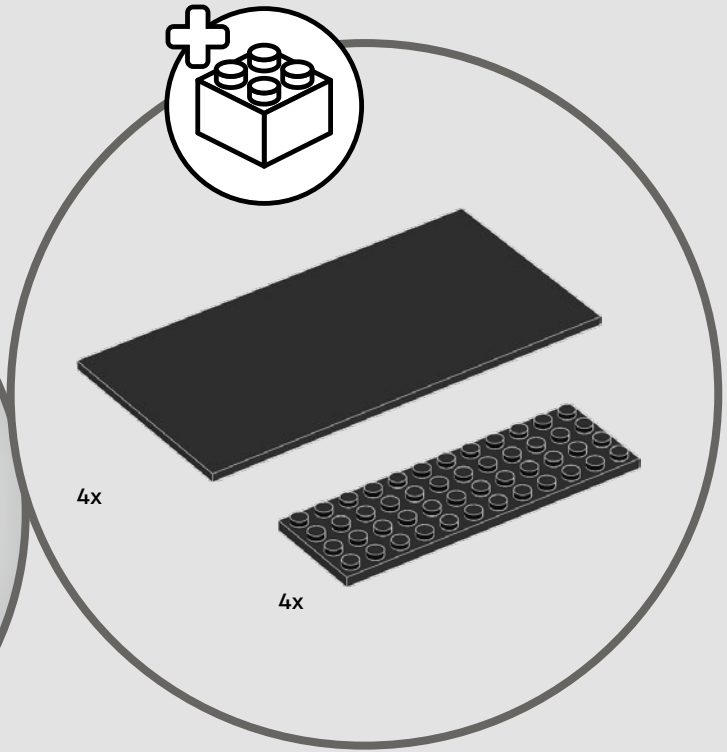



8x

503

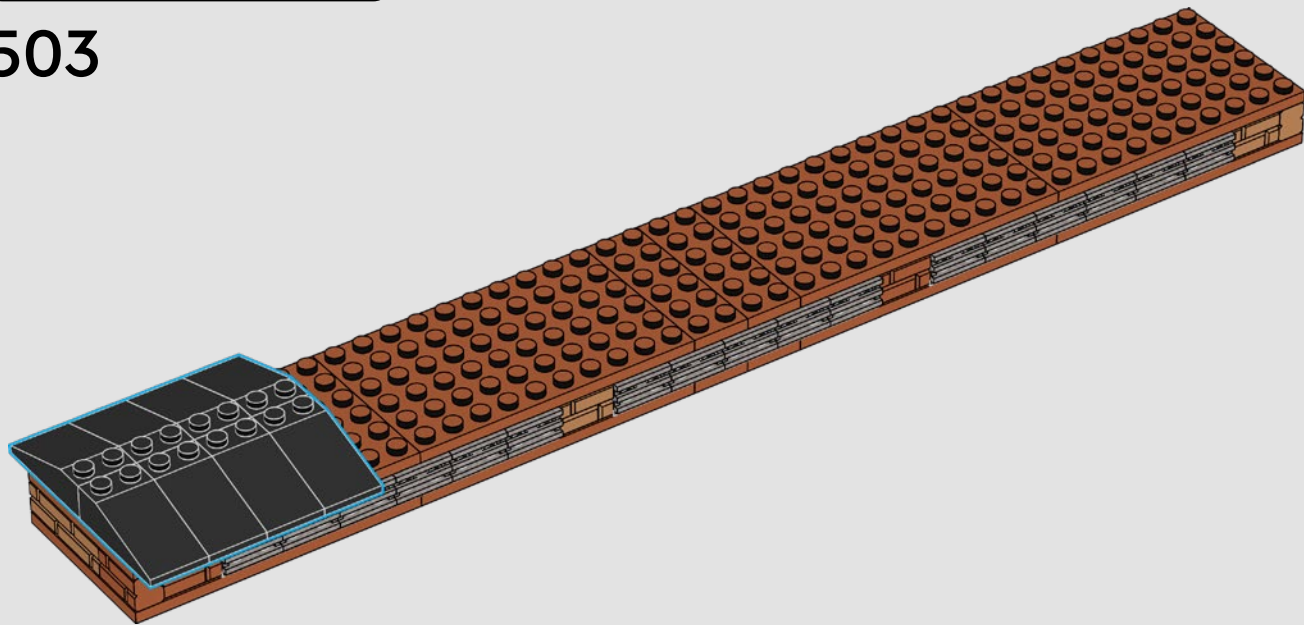

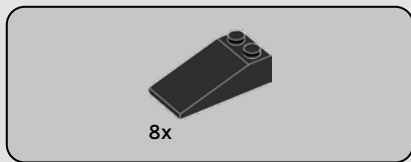

504

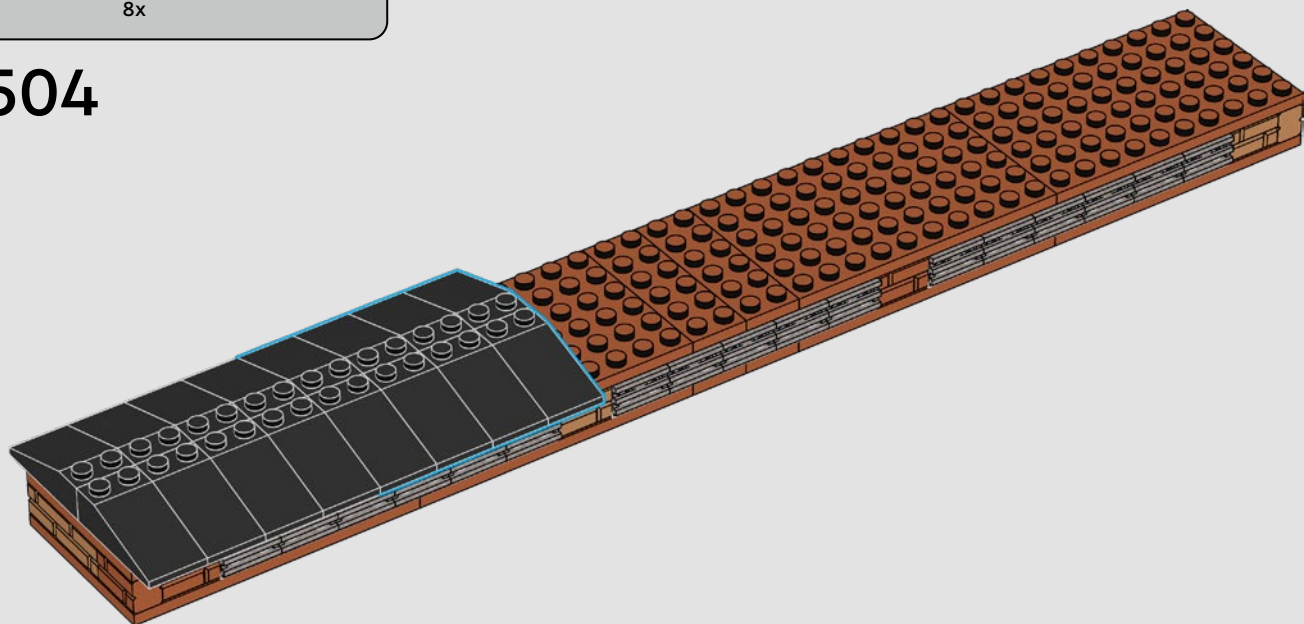



8x

505

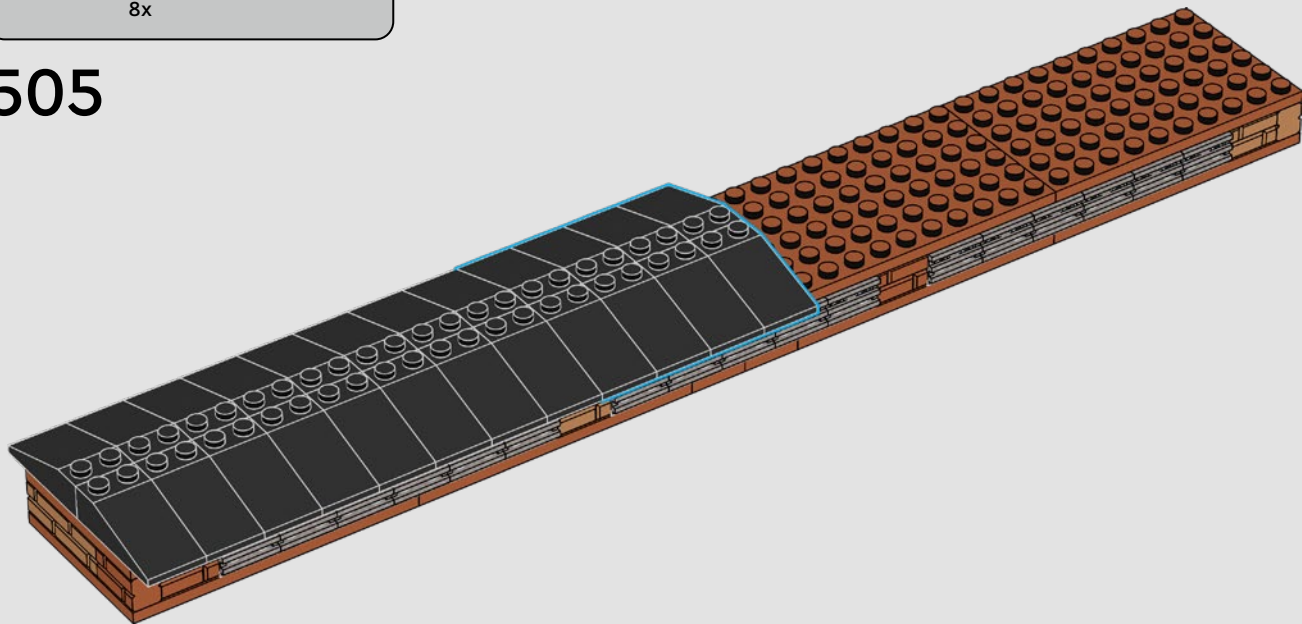



10x

506

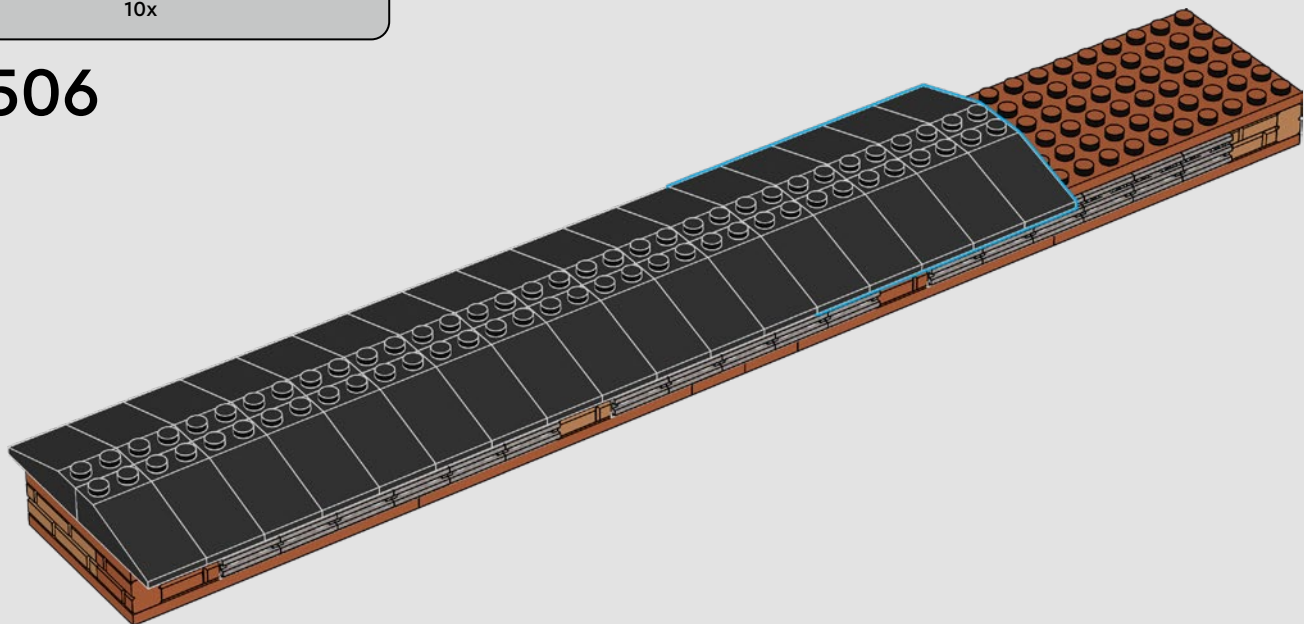



10x

507

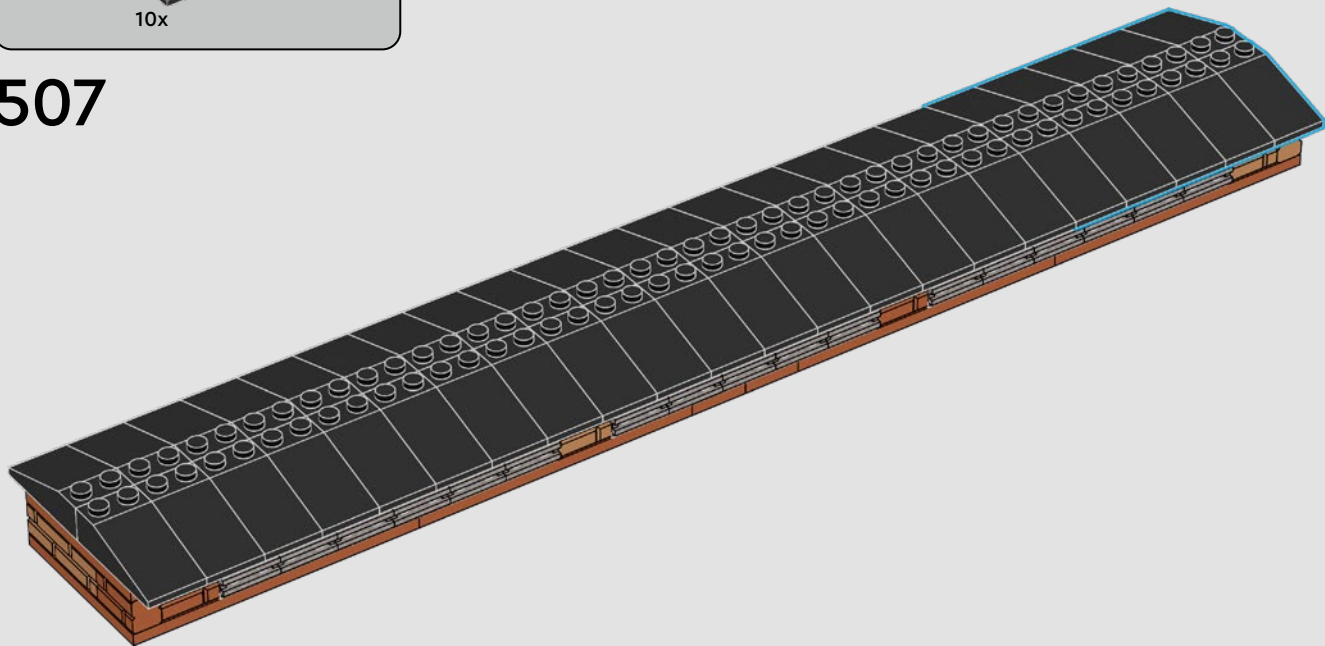

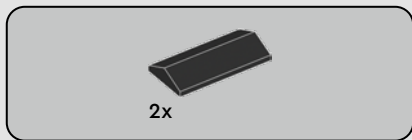

508

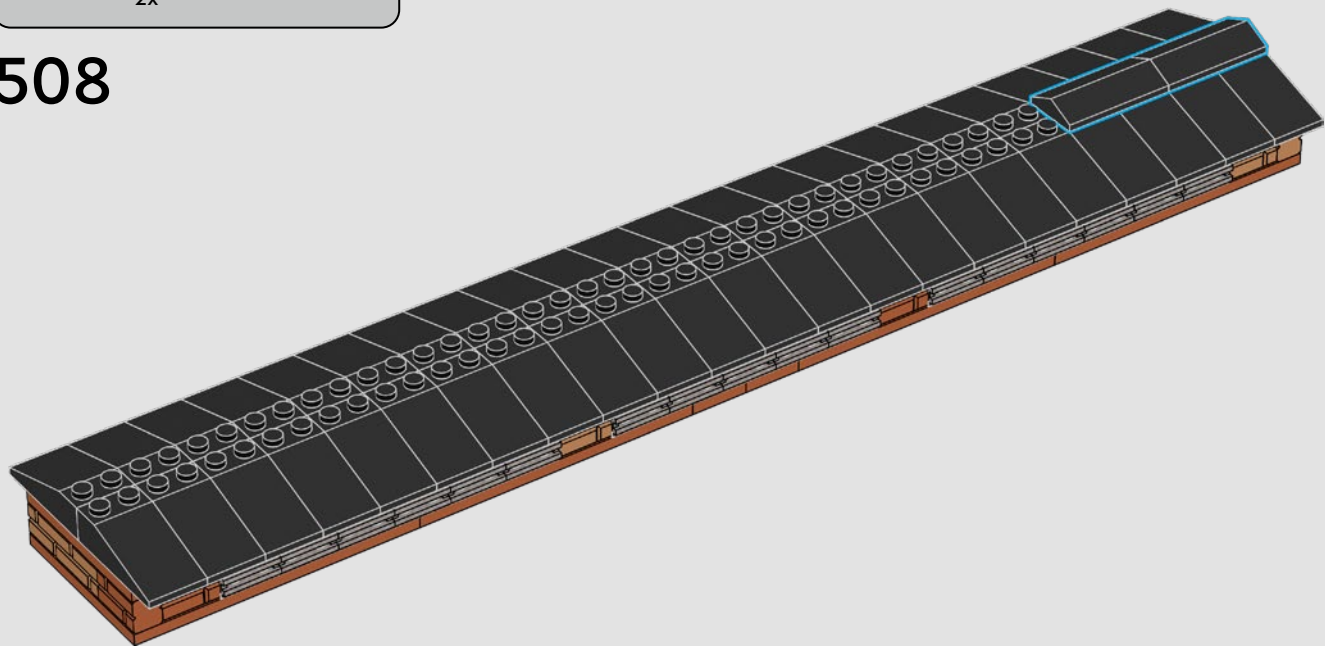

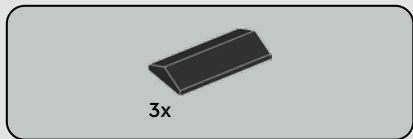

509

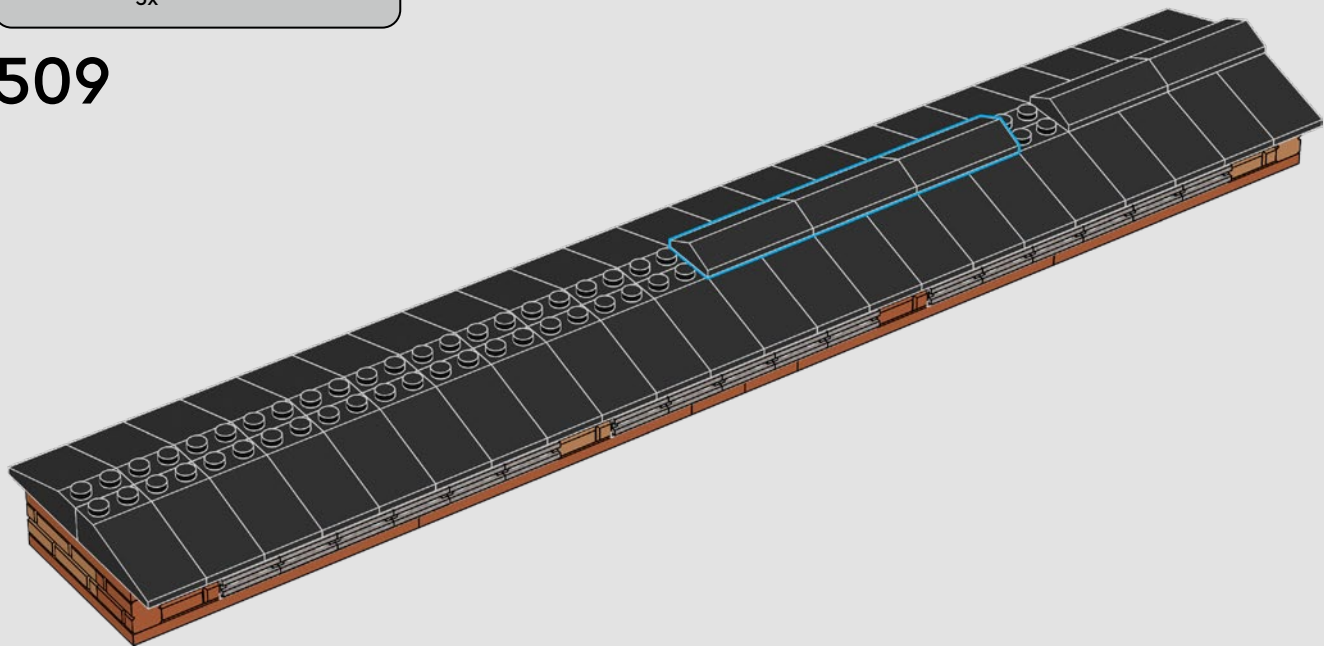

430

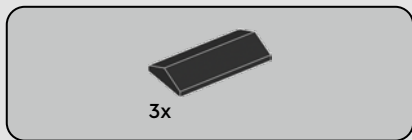

510

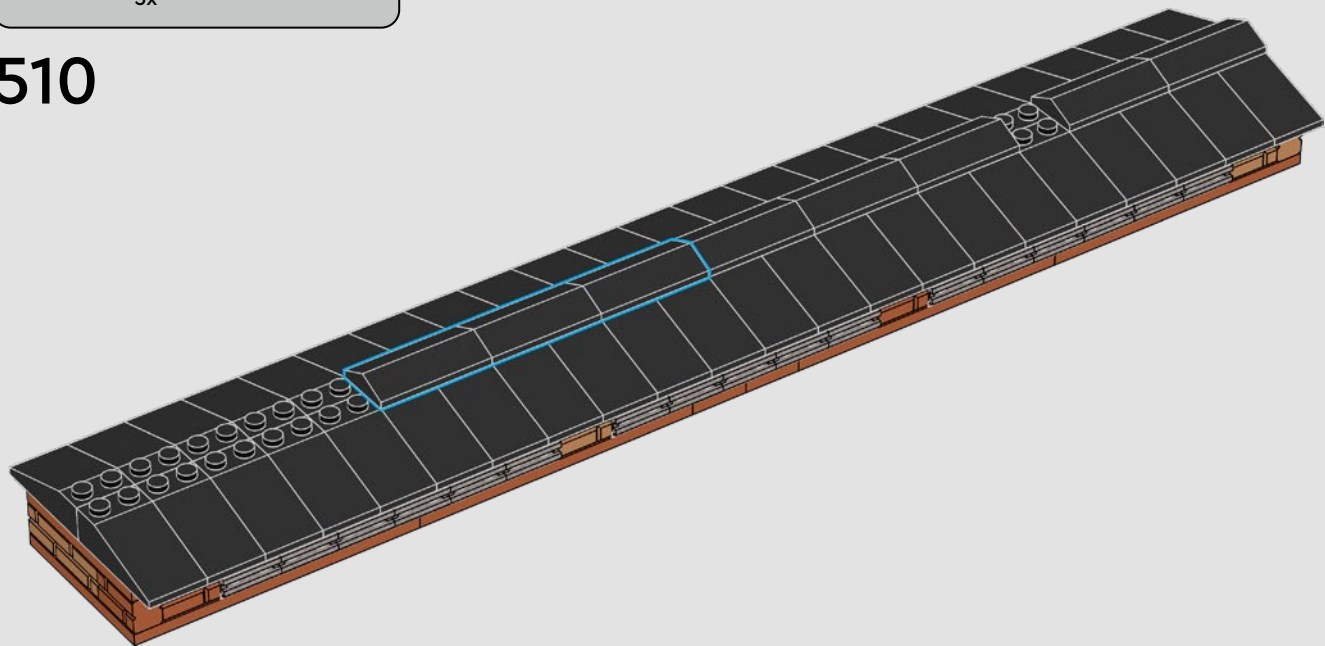

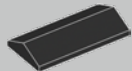

2x

511

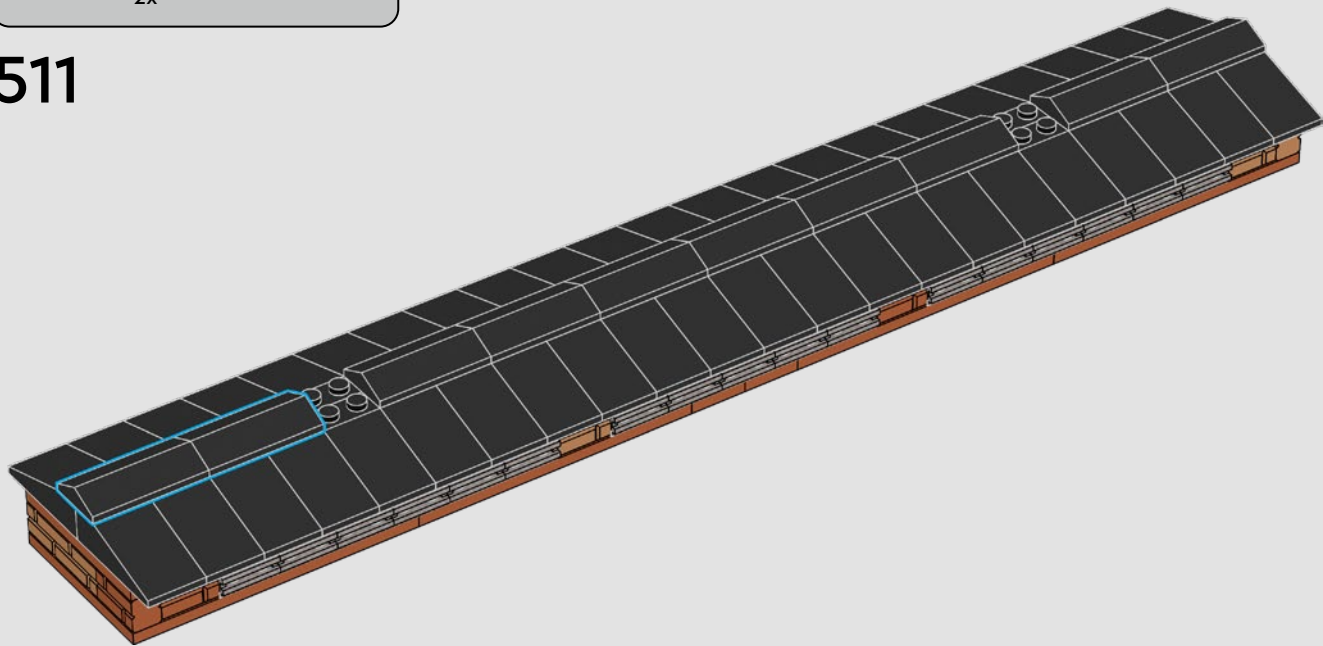

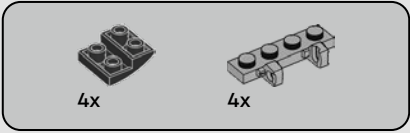

512

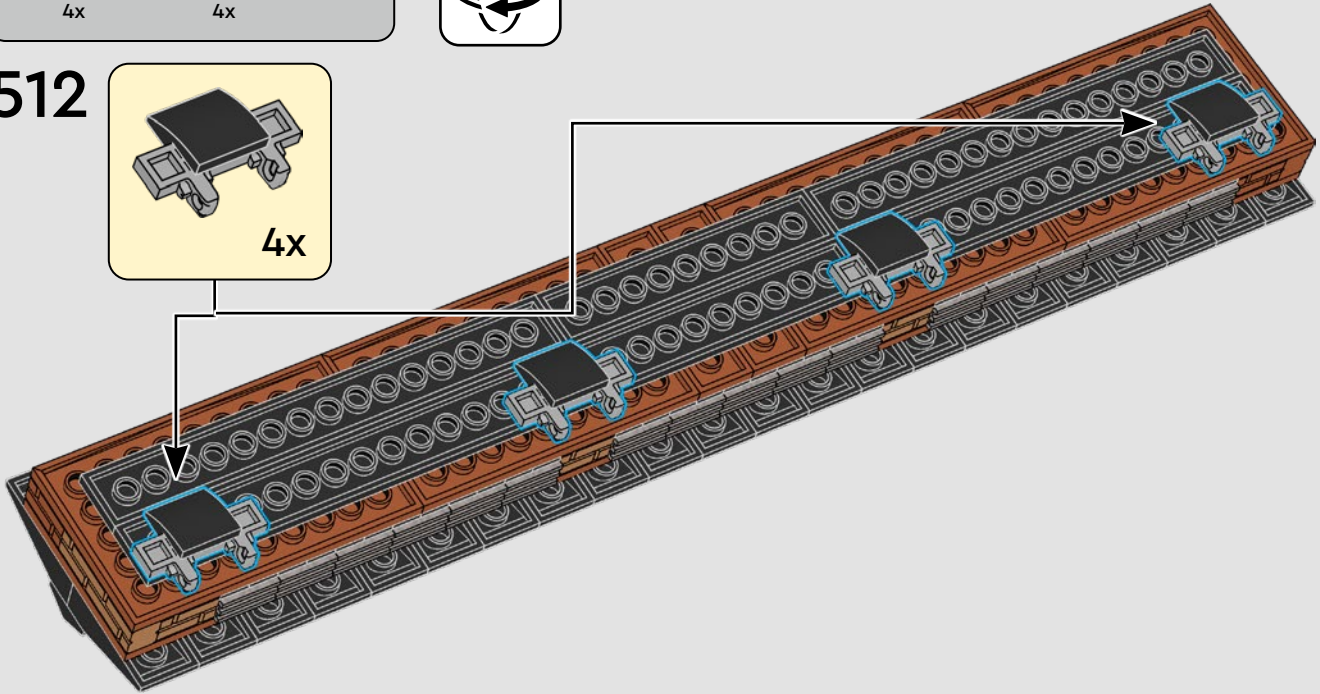
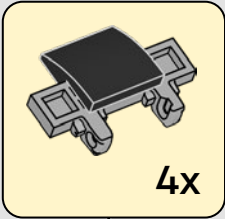

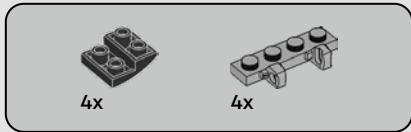

513

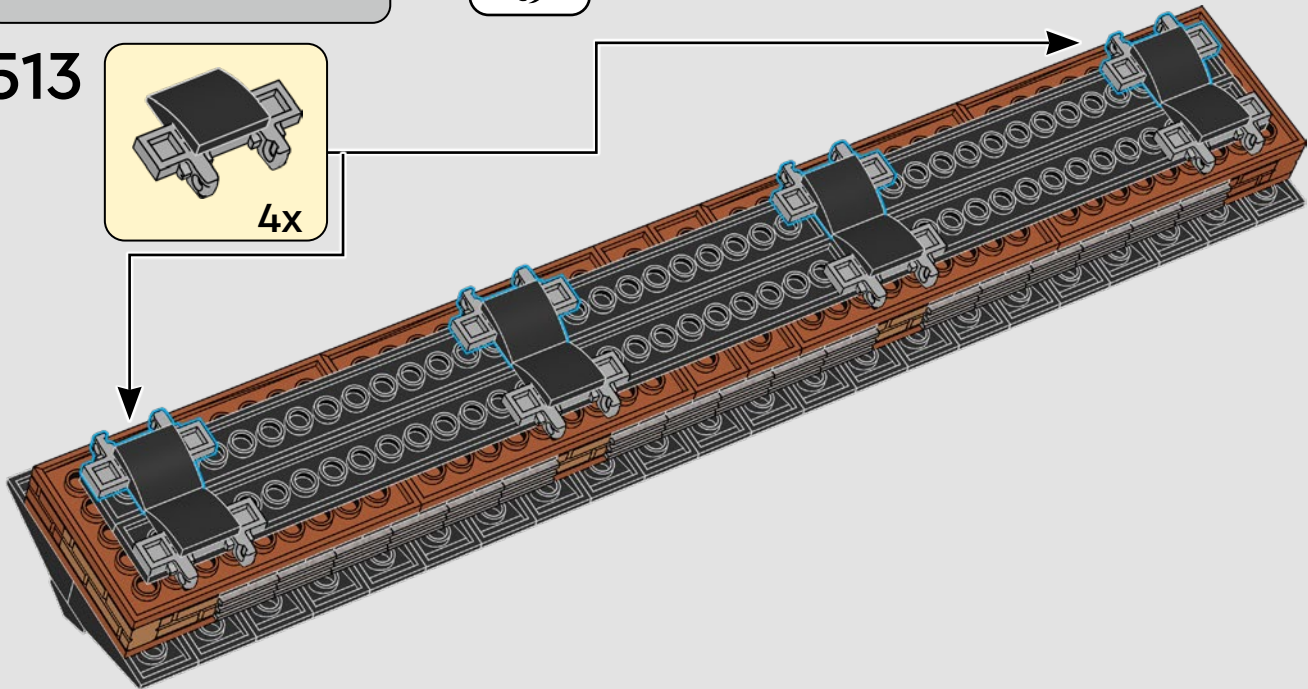
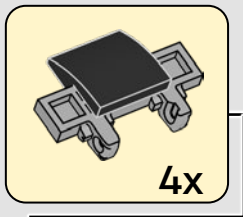



2x



2x



4x

514

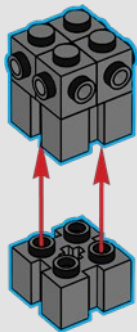

4x

515

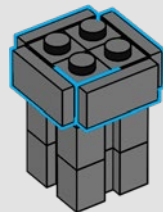



4x

516

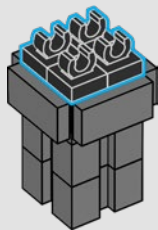

2x

517

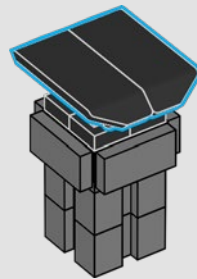

2x

518

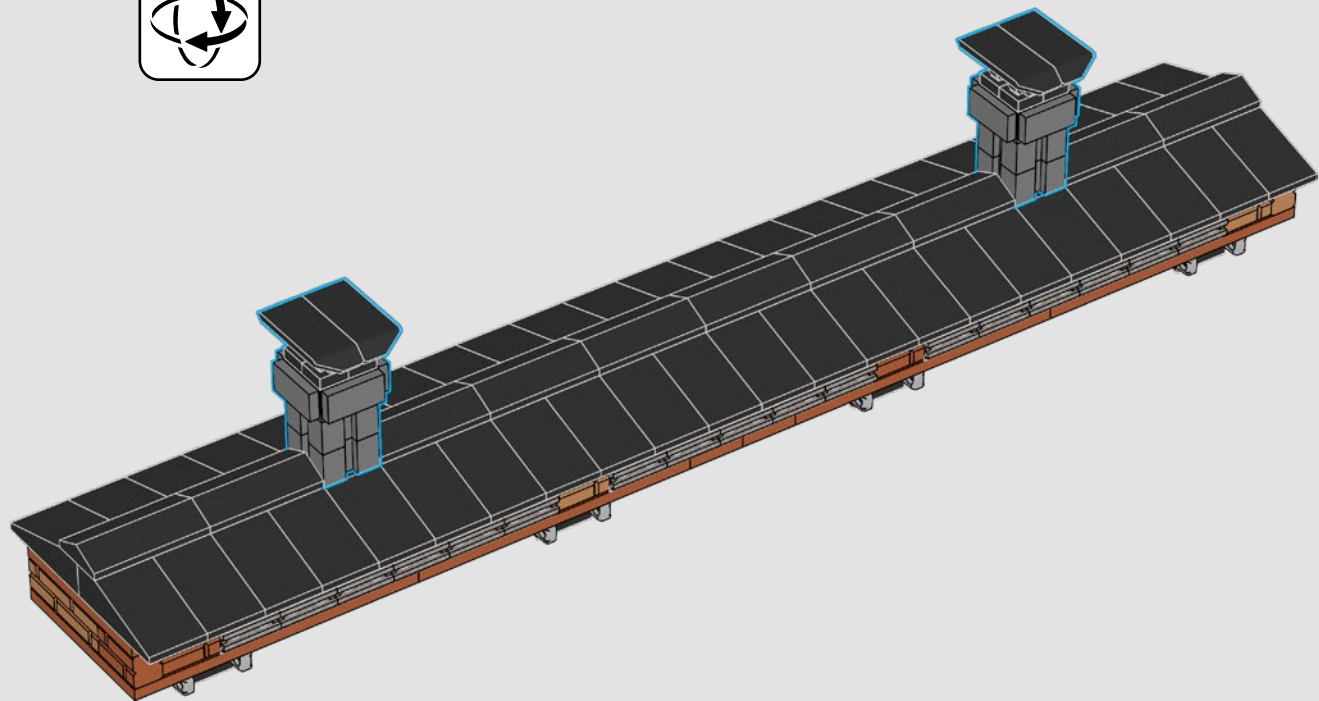

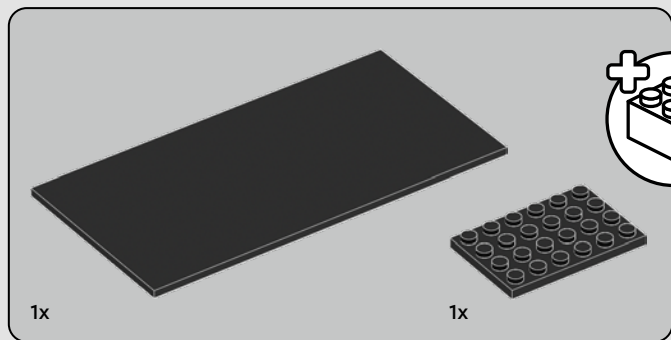
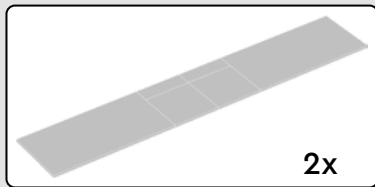

519

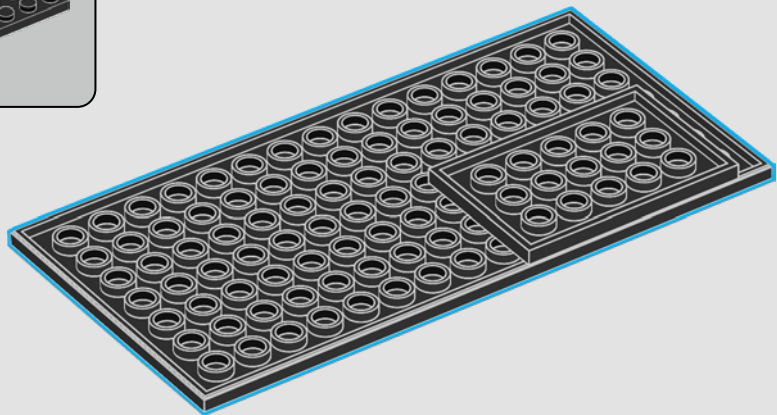

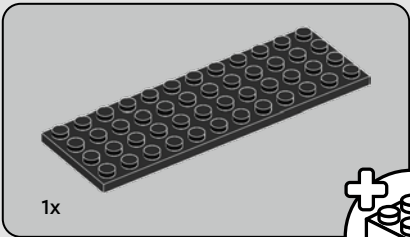

520

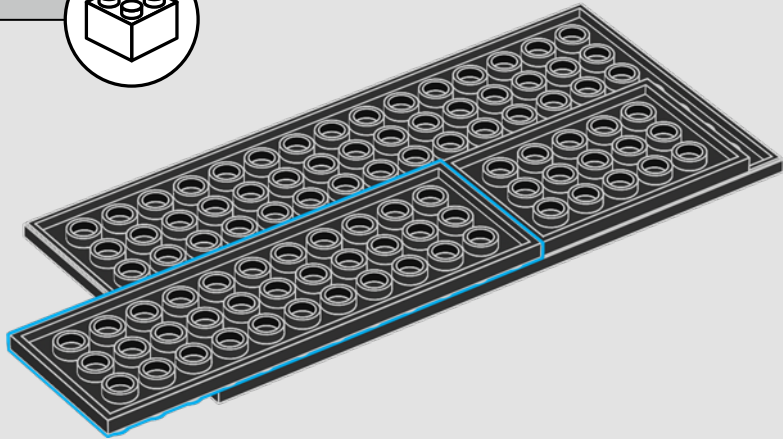

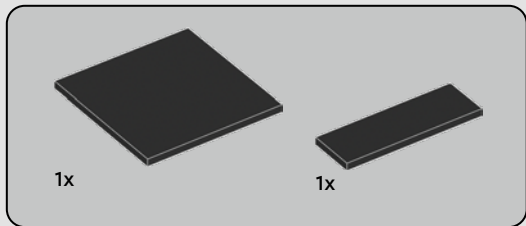

521

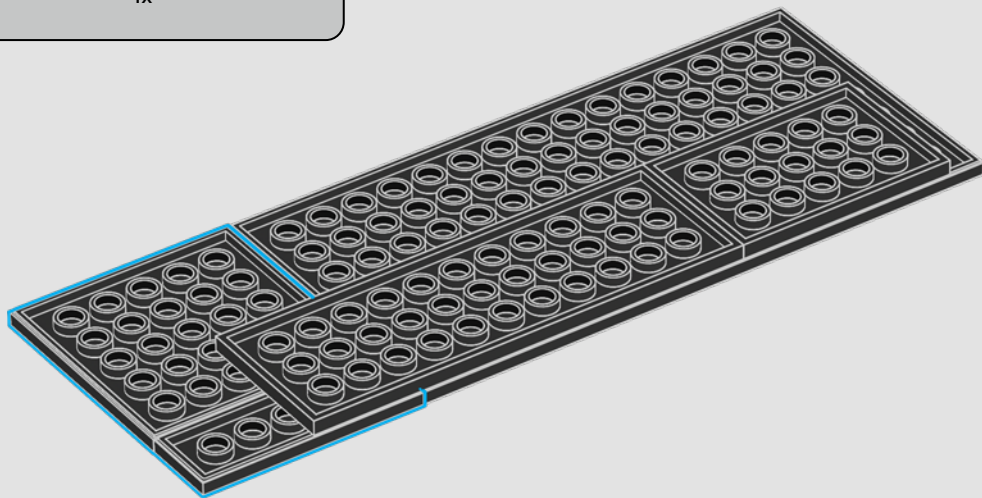

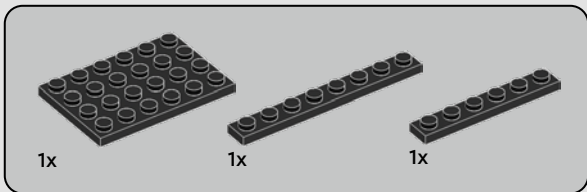

522

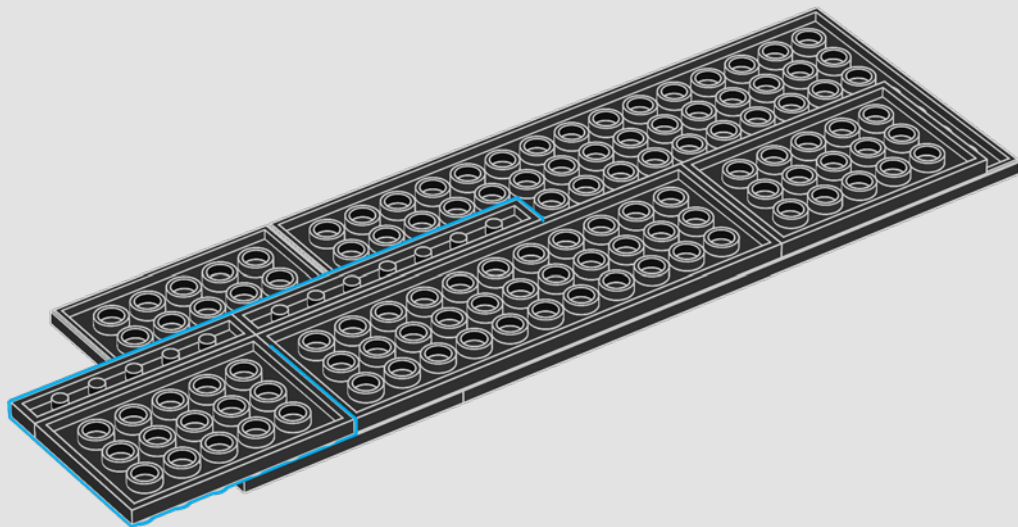

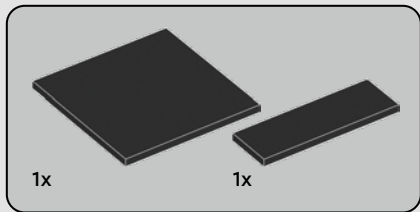

523

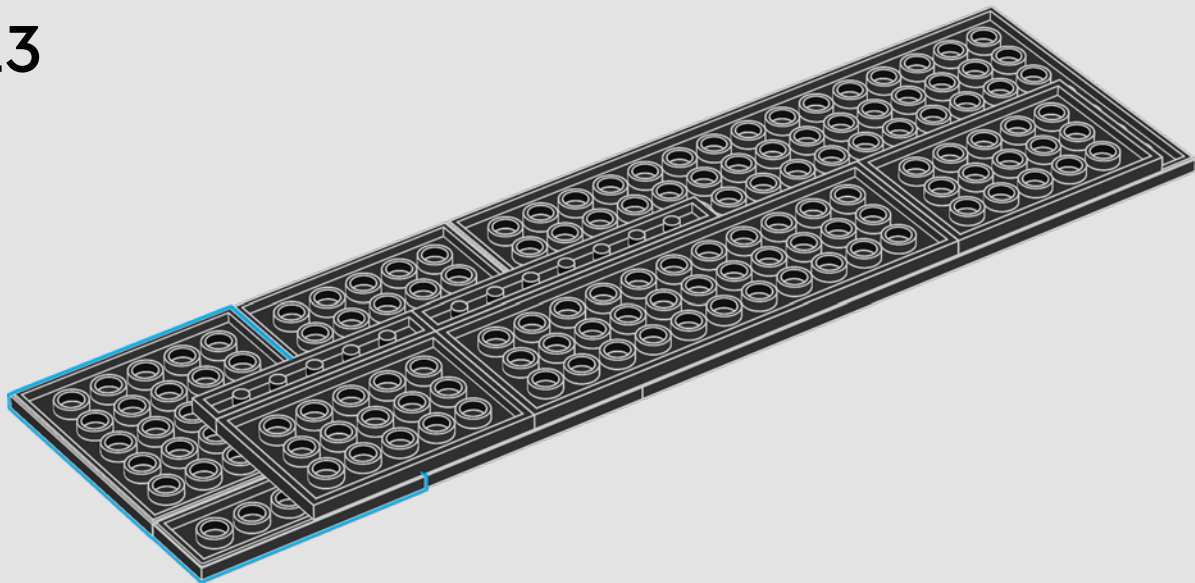

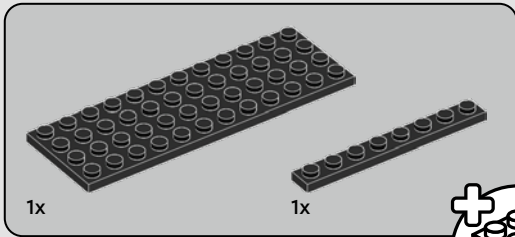

524

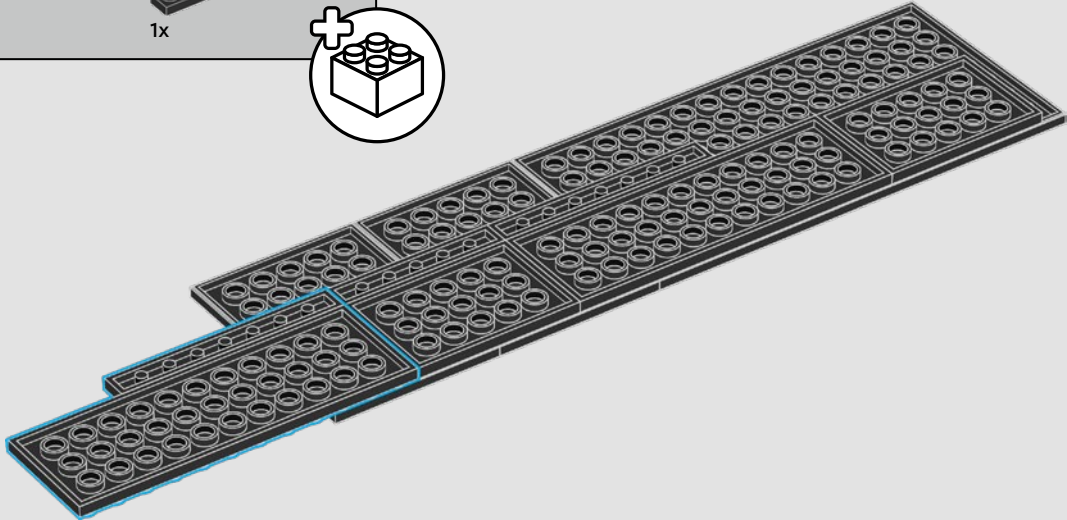
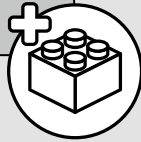

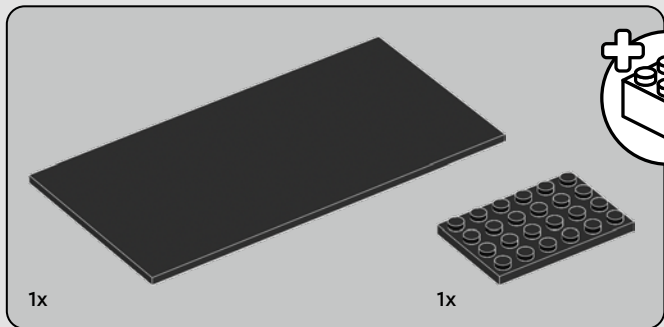

525

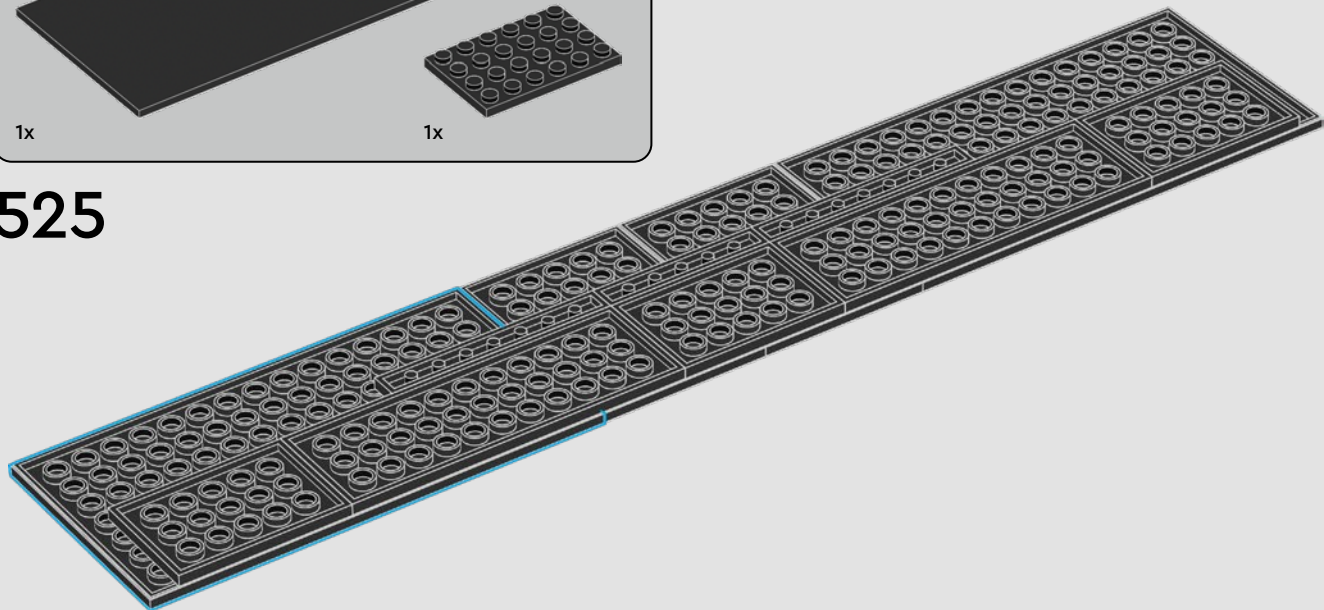



4x



8x

526

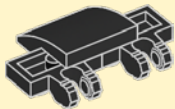

4x

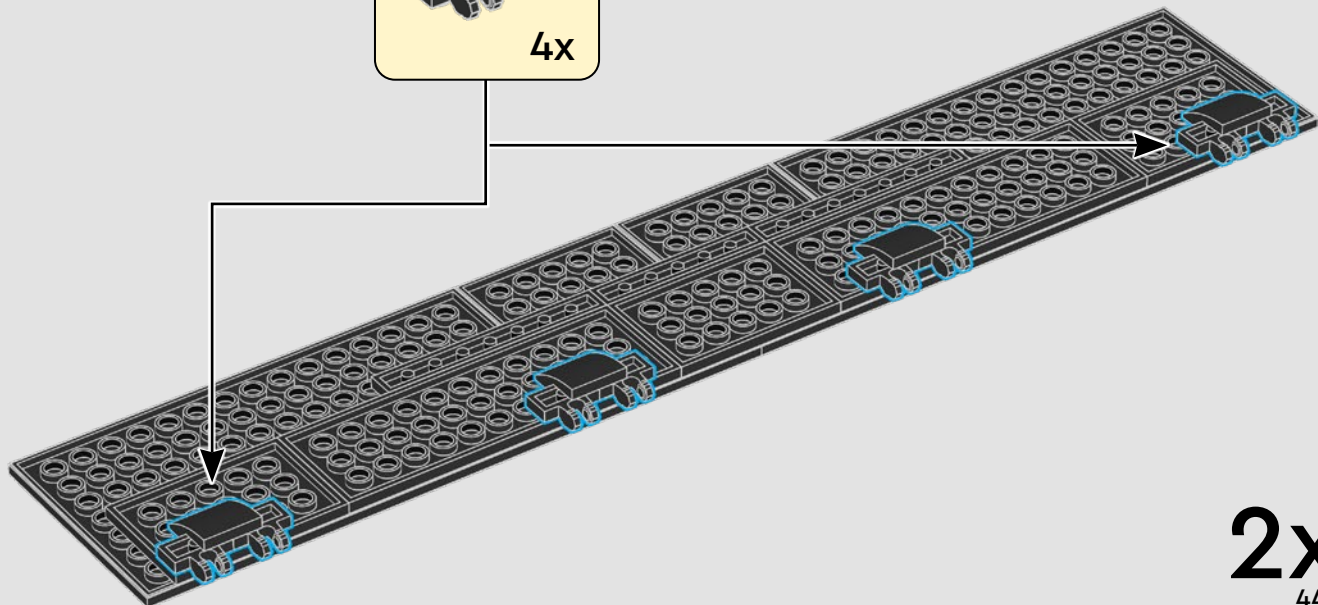

2x
445

527

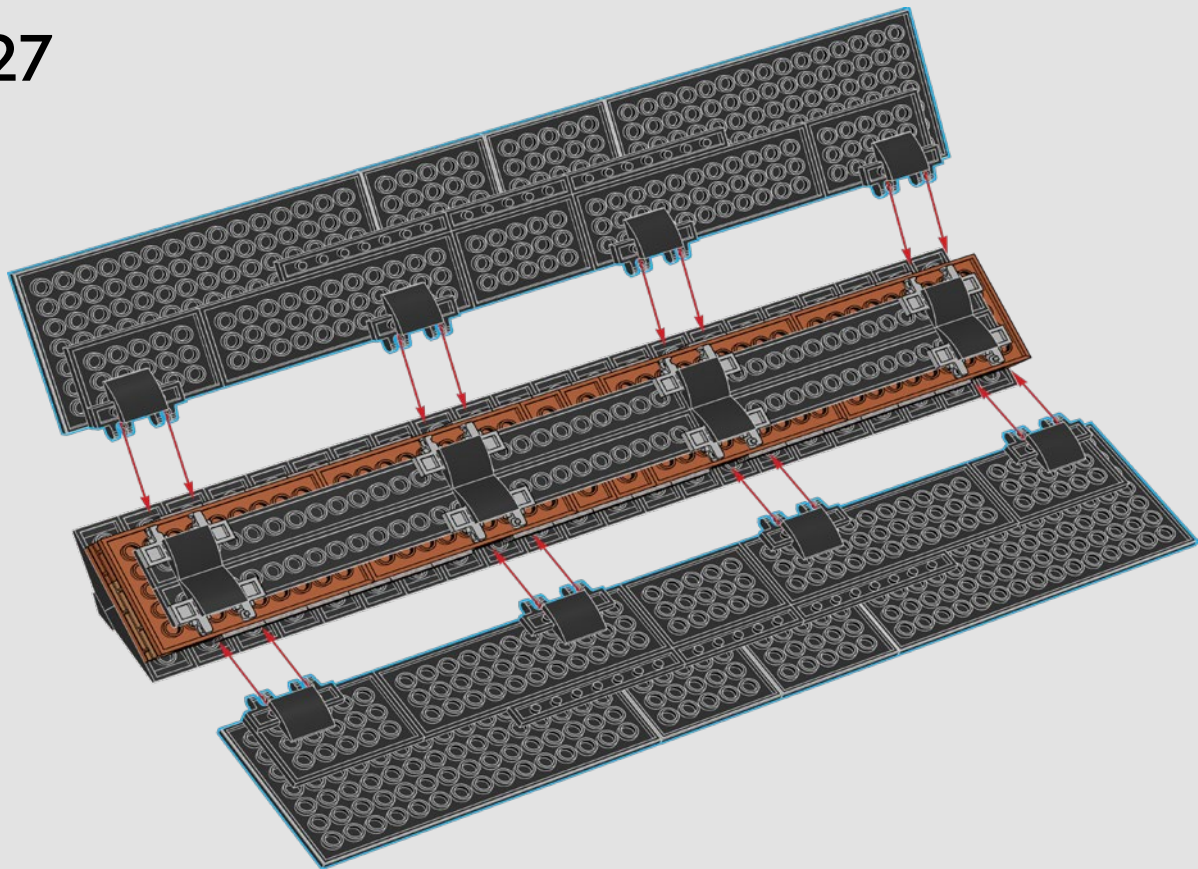

528

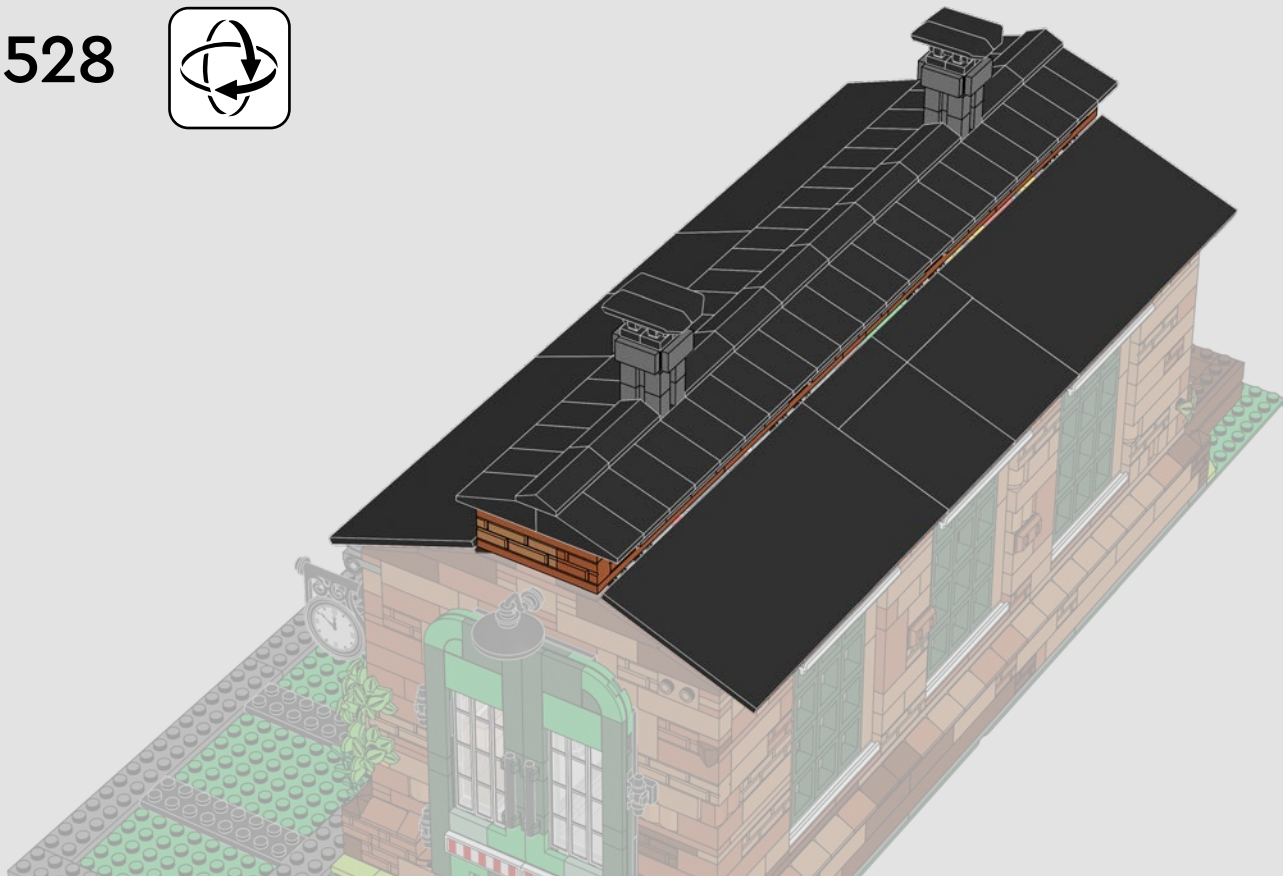
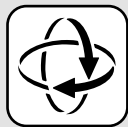

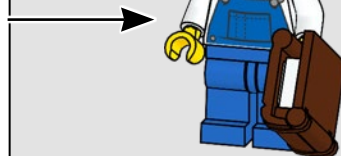
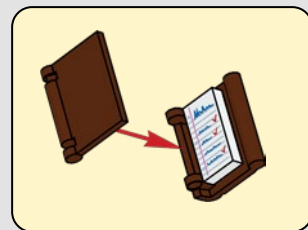
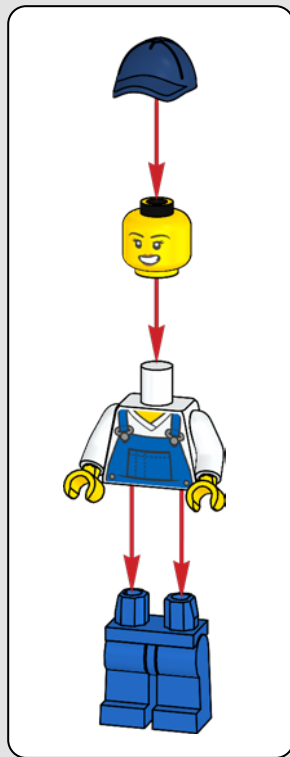

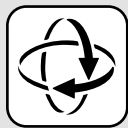
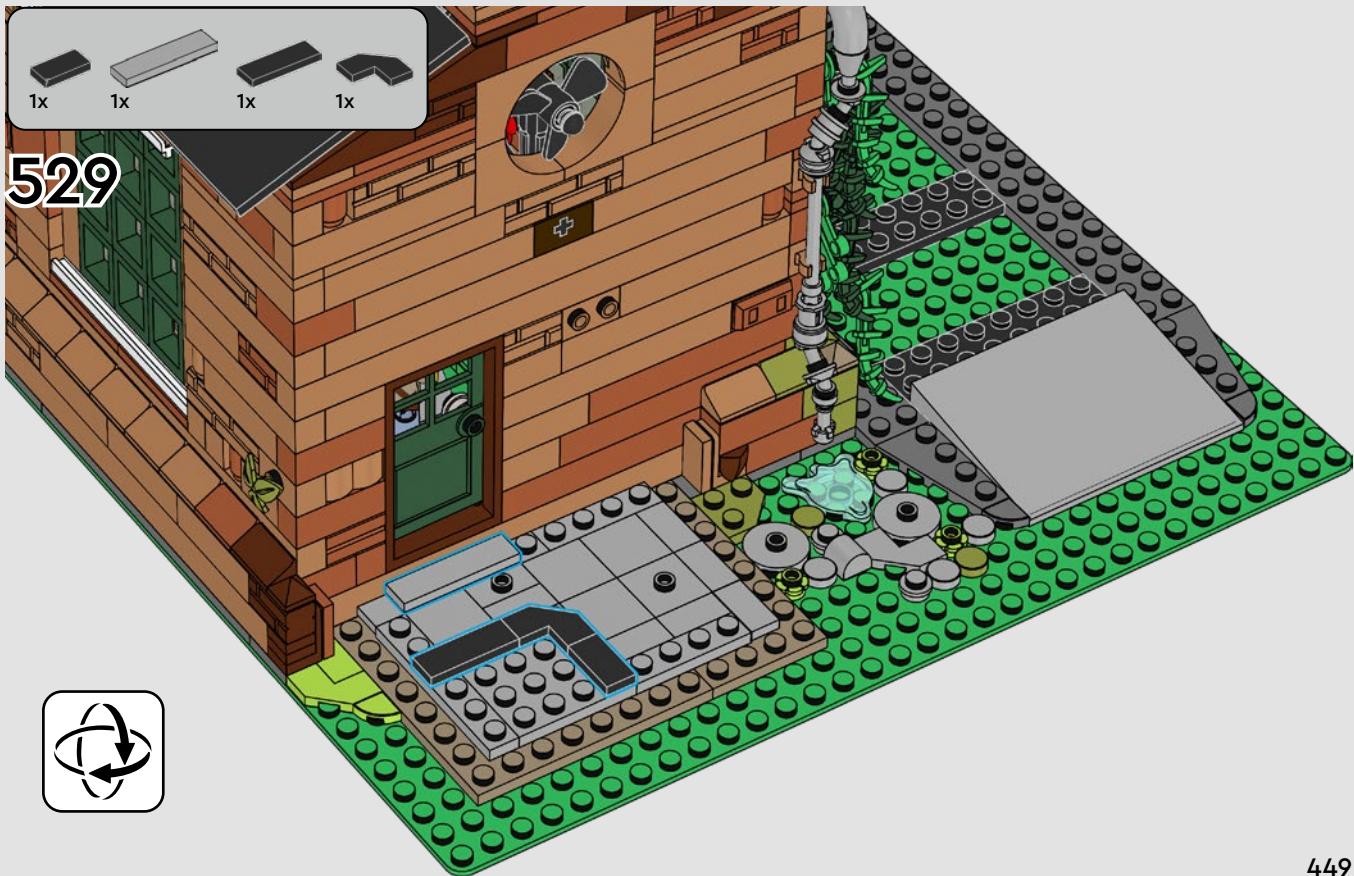

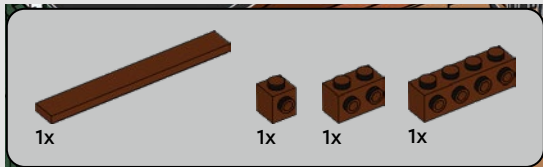

530

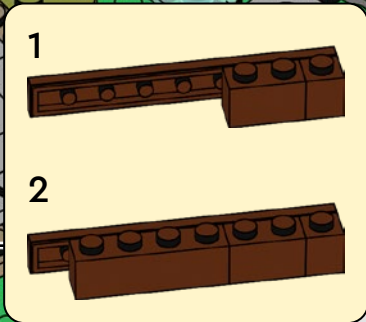
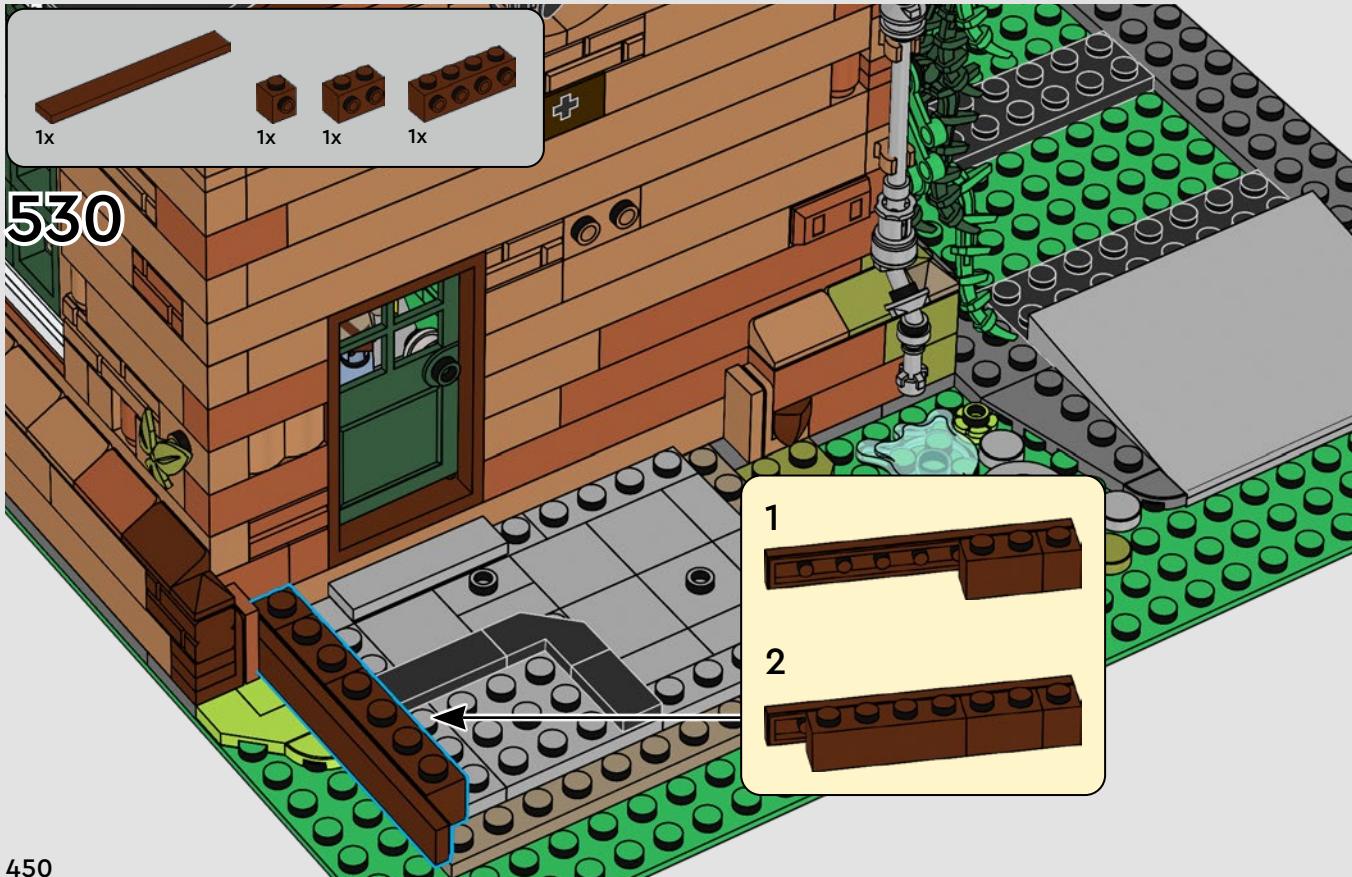



1x



1x

531





3x

532





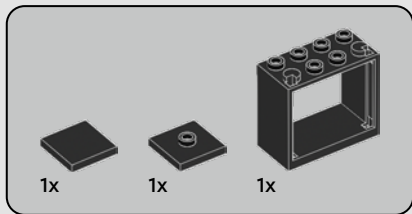

535

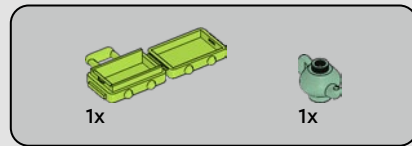
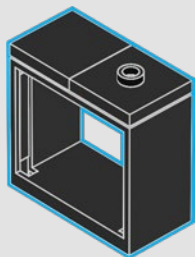

536

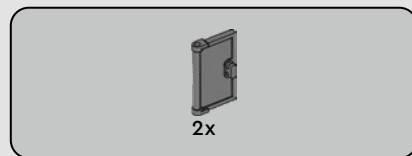
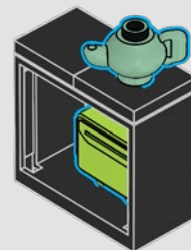

537

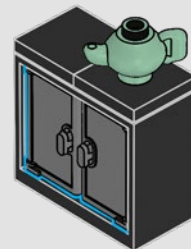

538







540

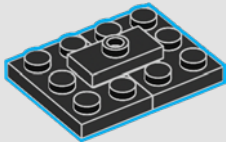

541

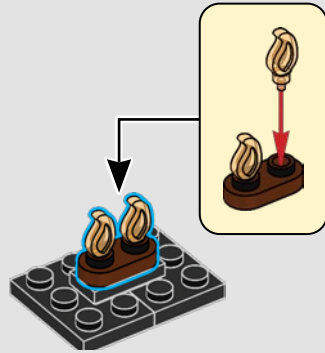

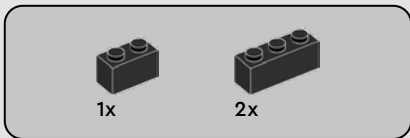

542

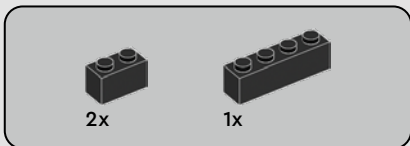
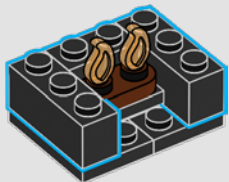

543

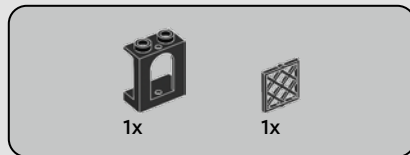
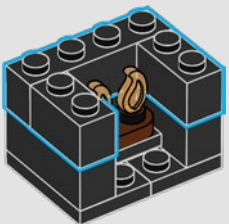

544

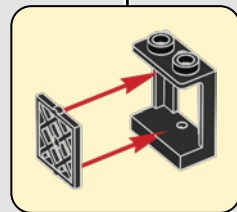
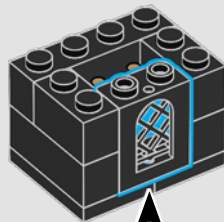

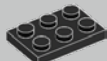

2x

545



1x



2x

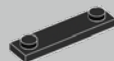

1x

546

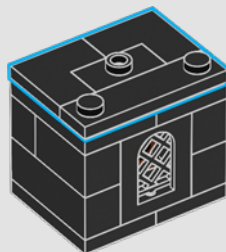

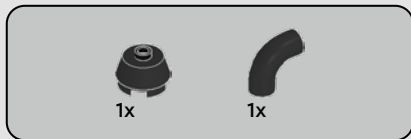

547

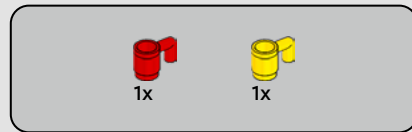
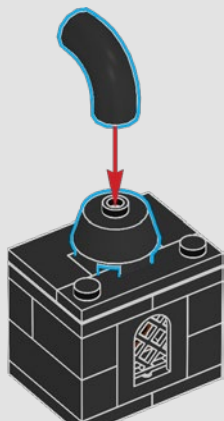

548

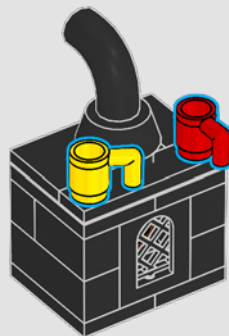

549



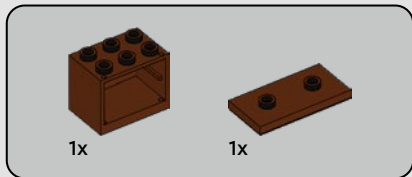

550

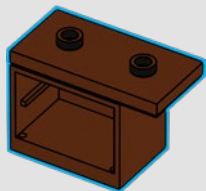

551

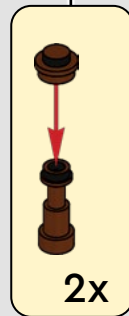
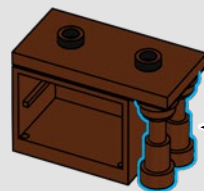



1x

552



1x

553





1x



1x



1x

554

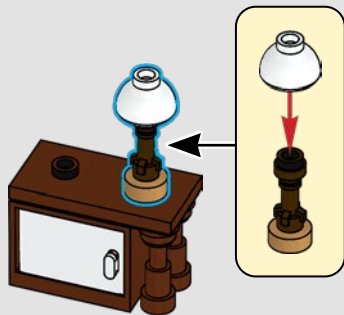

1x



1x



1x



1x



1x

555



1

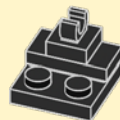

2



3



556







558

1x

1x





5x



1x

559





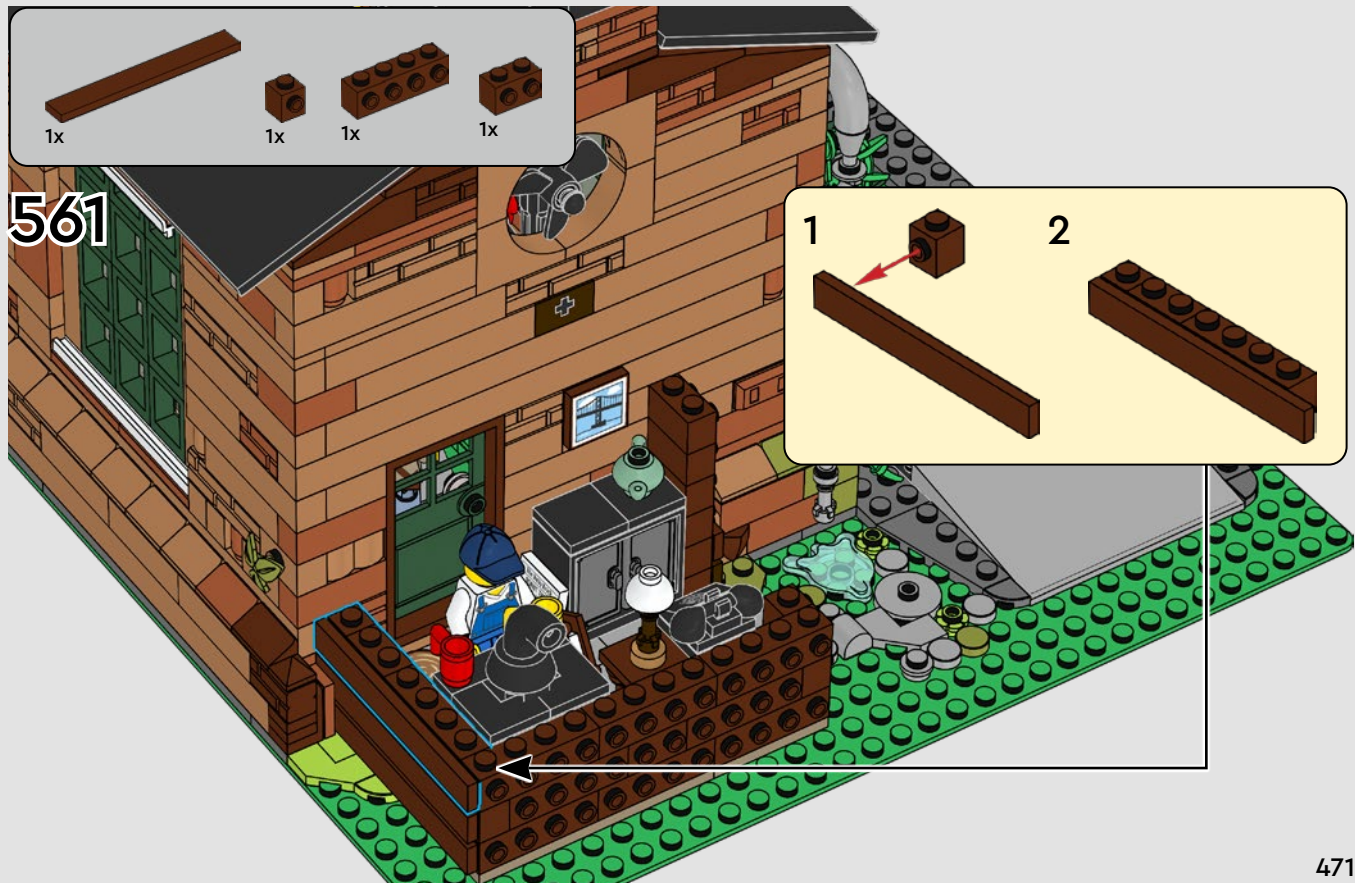



1x



3x

562





1x



2x

563





1x



1x

564





1x



1x



1x

565







1x



1x

567

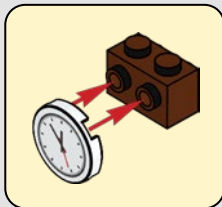



2x



2x

568



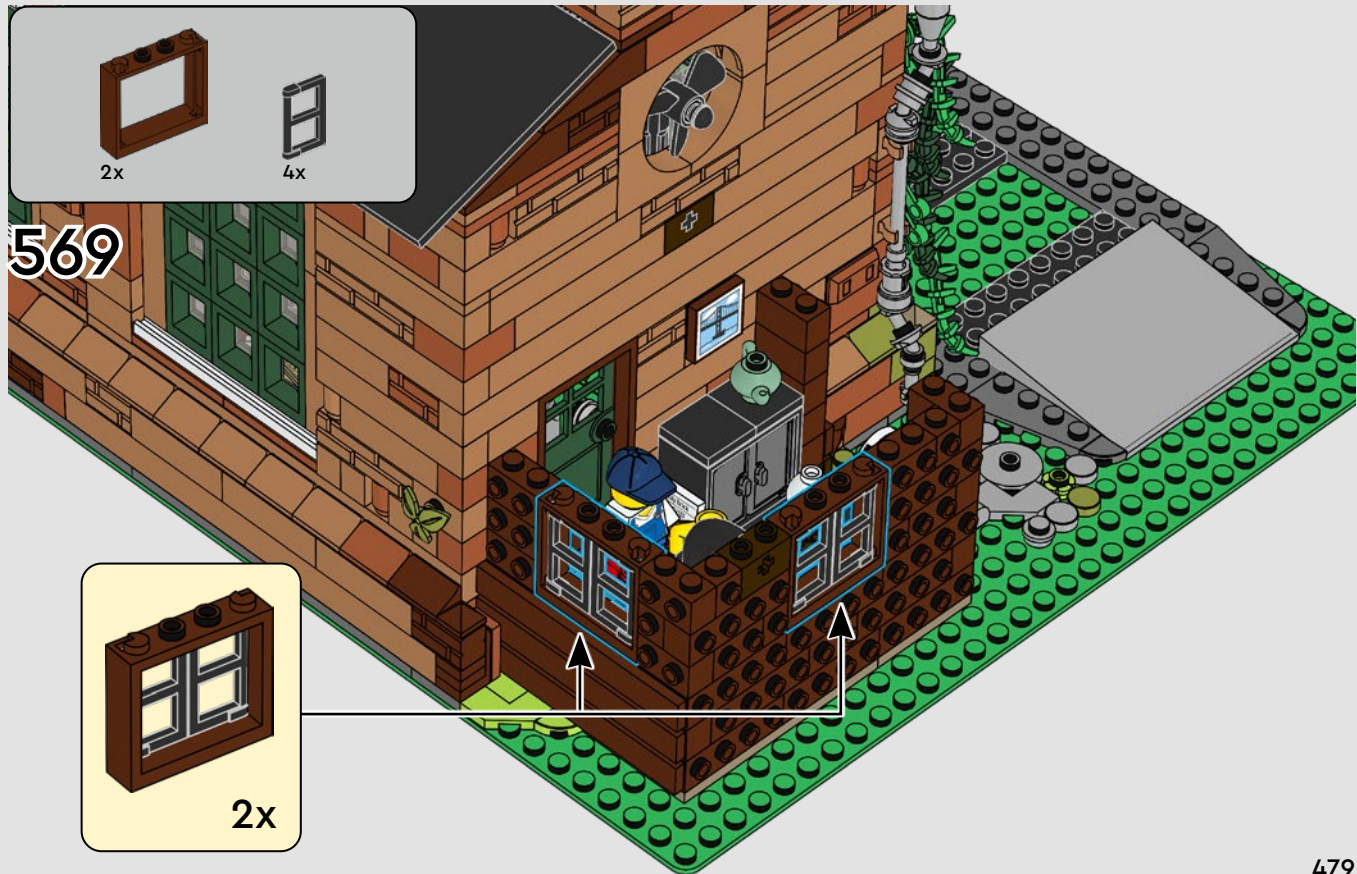

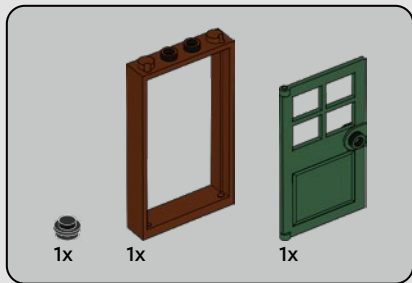

570

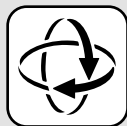



2x



5x



2x

571





2x



2x

572



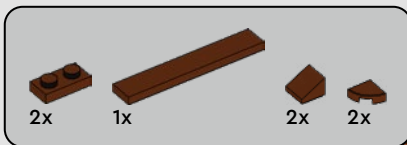

573





2x



2x

574





4x

575





8x

576





3x

577



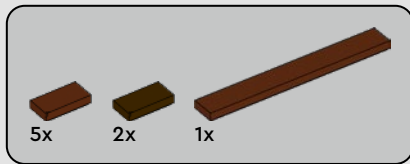

578



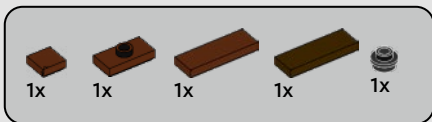

579





580





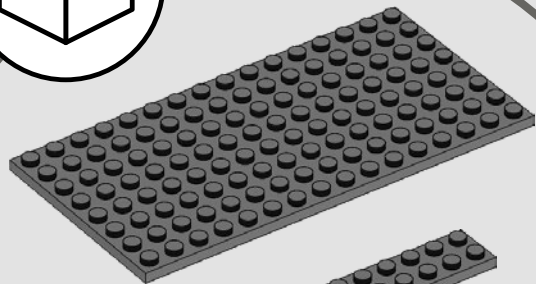
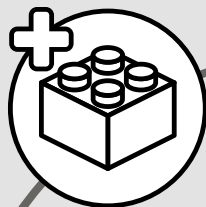

3x

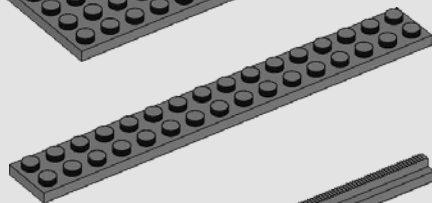

6x

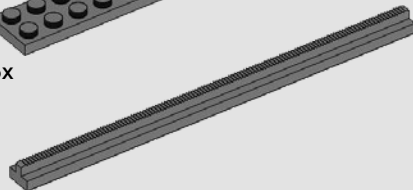

6x

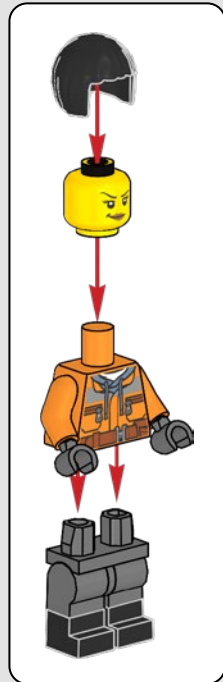
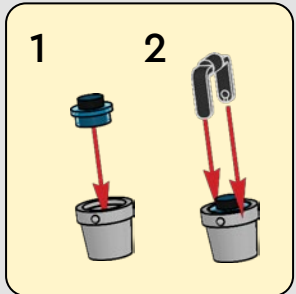
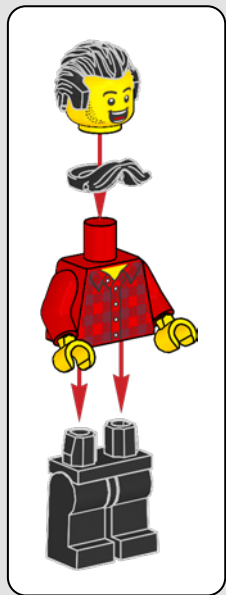



1x



1x



1x

583

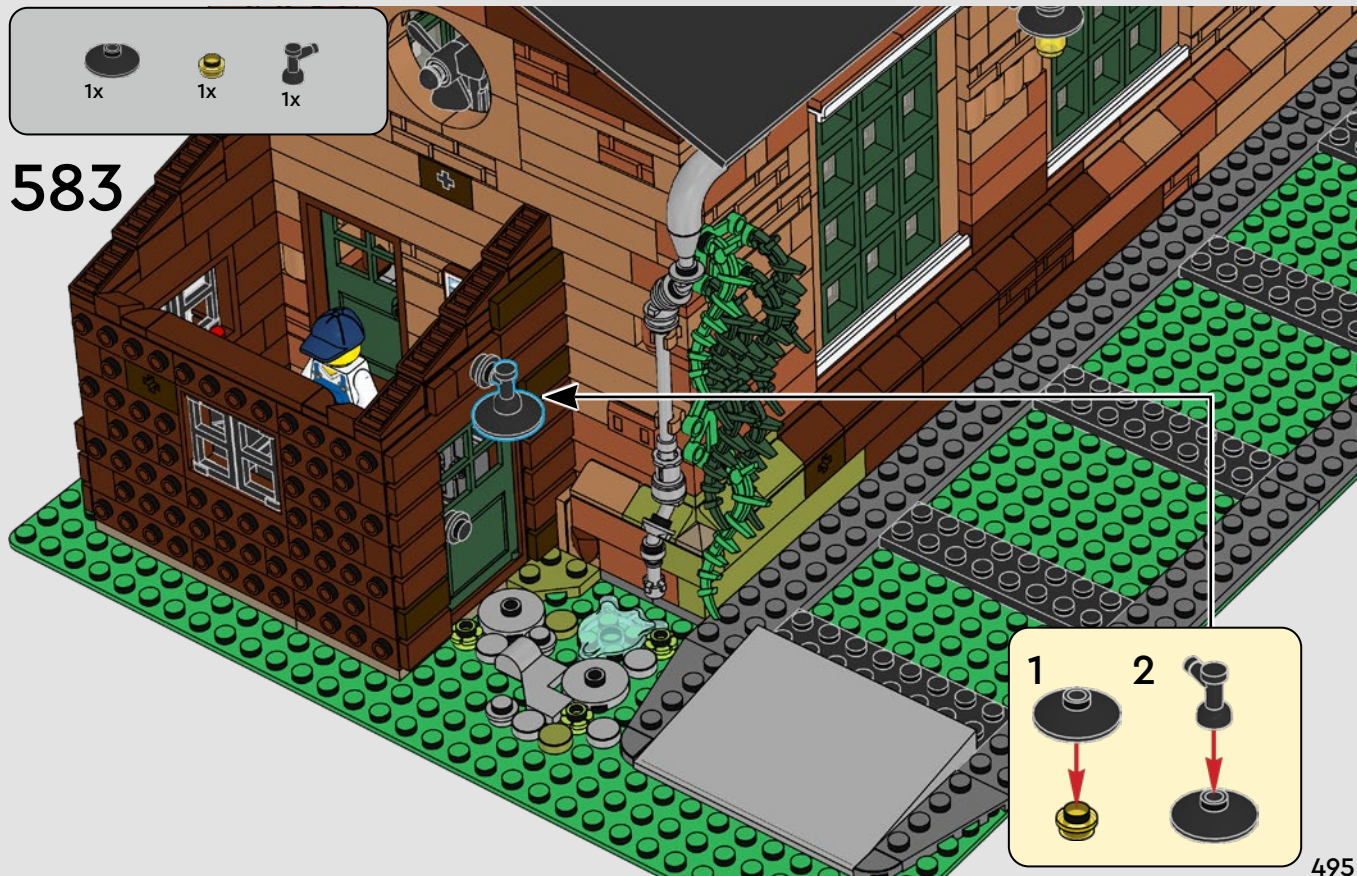

1



2



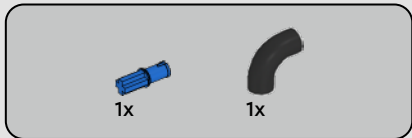
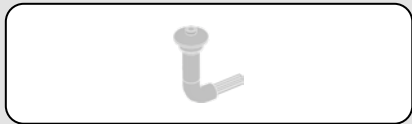

584



585

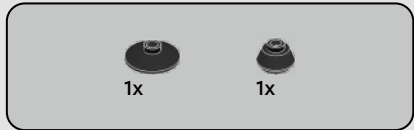

586

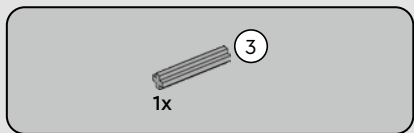

587

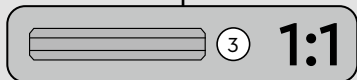
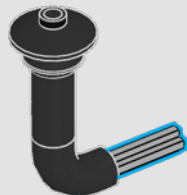

588



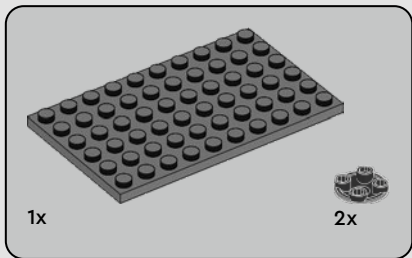
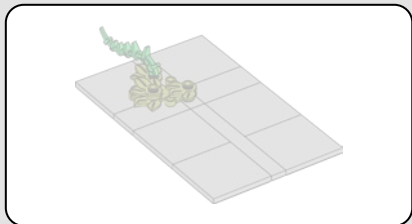

589

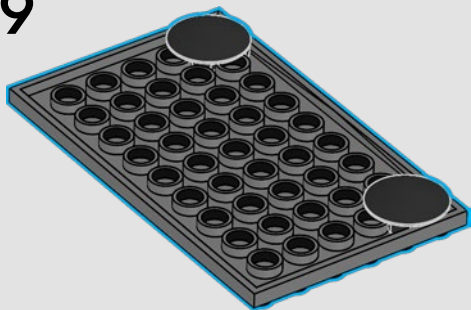

498

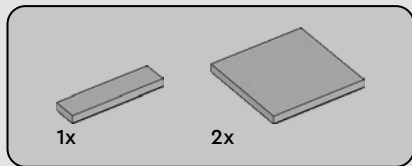

590

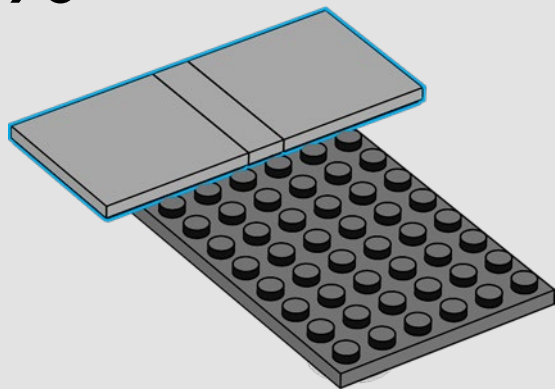

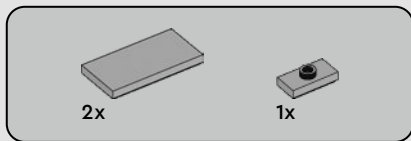

591

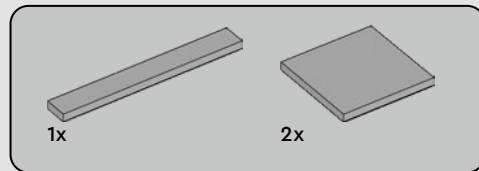
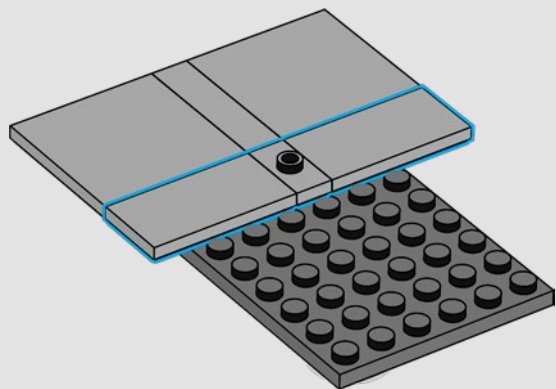

592

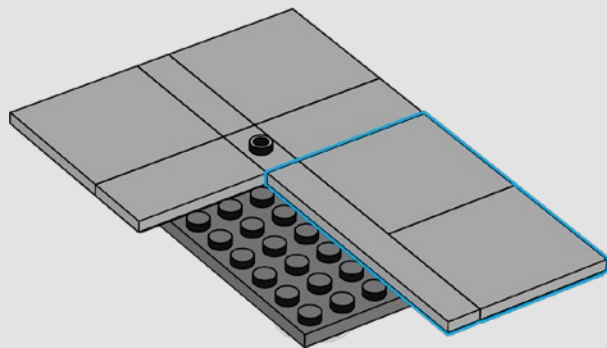

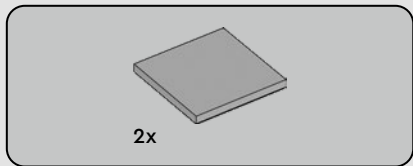

593

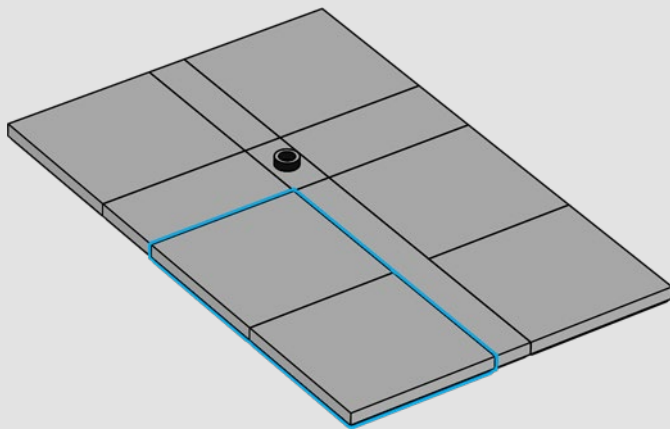

500

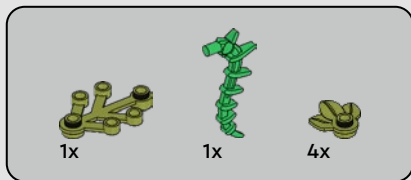

594

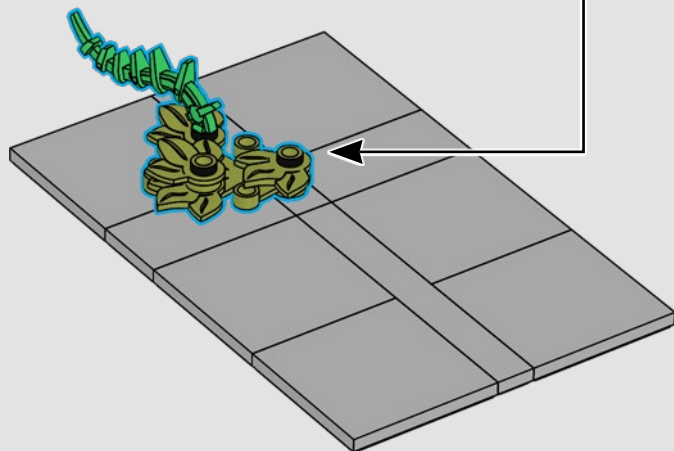

595



502

596





1x

597





598

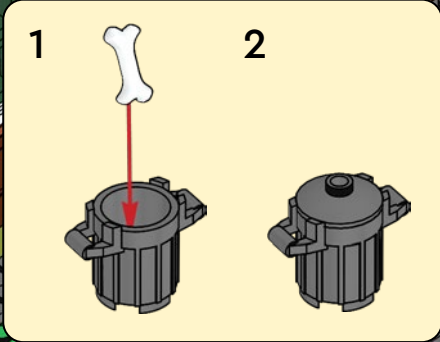

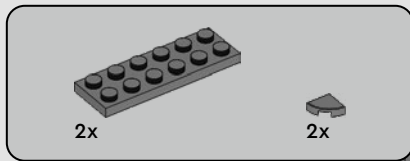

599



506

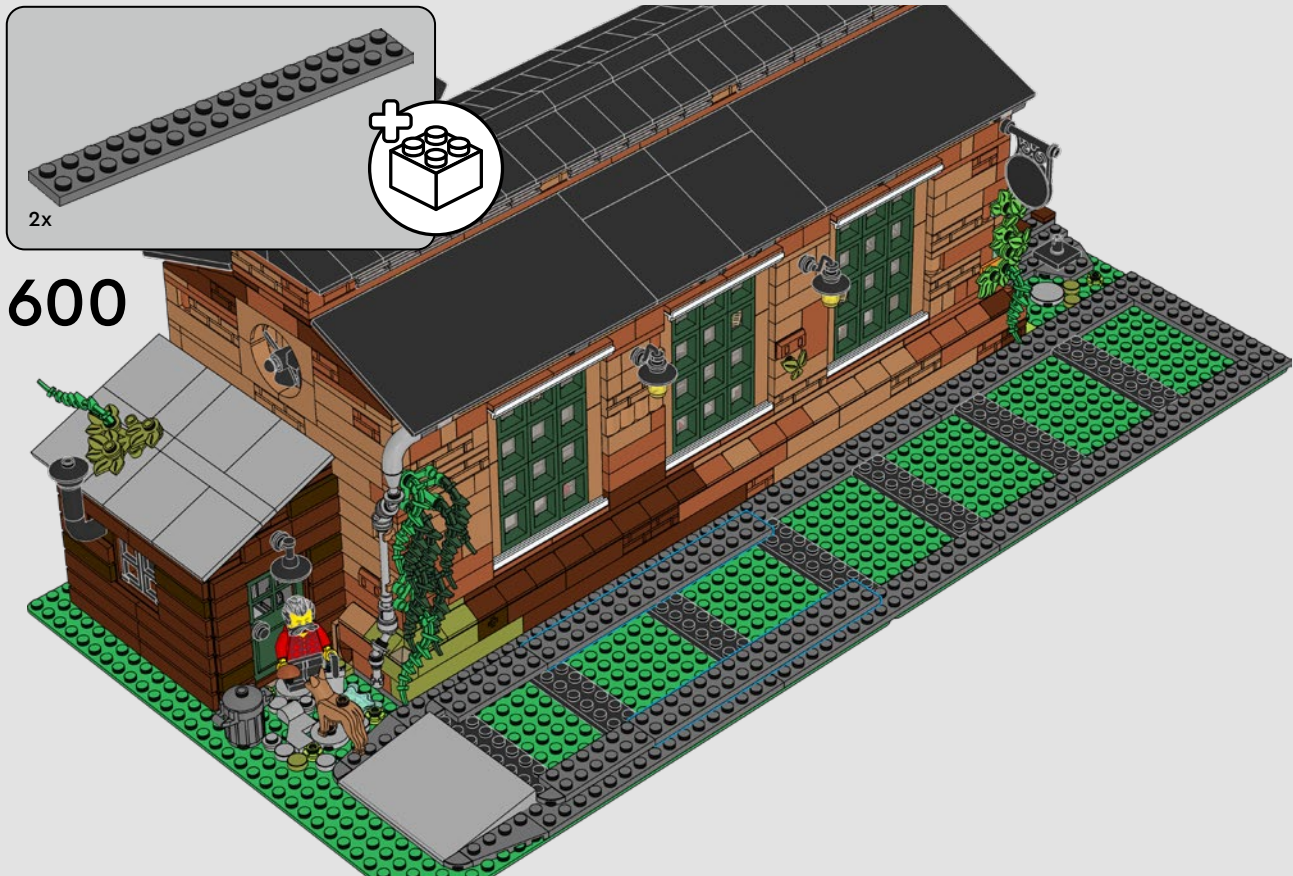

2x

600

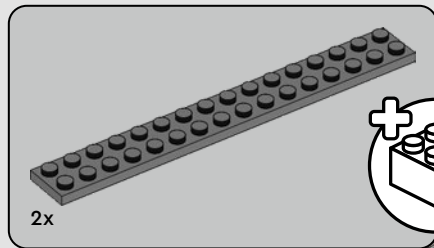

601



508



602

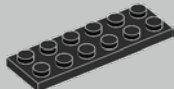

3x

603



510

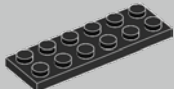

4x

604



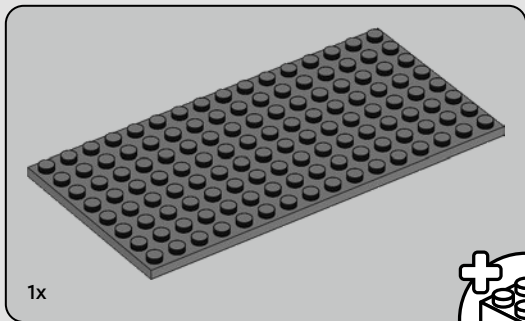

605





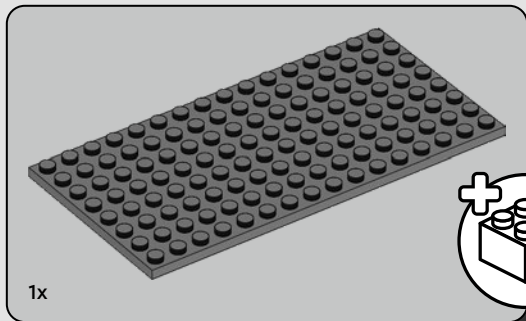

607



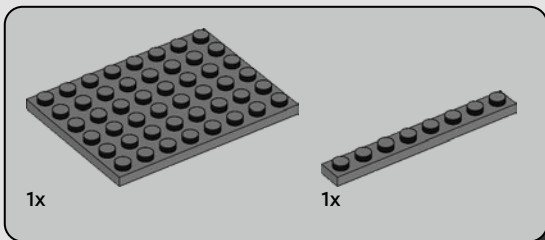

608





8x

609



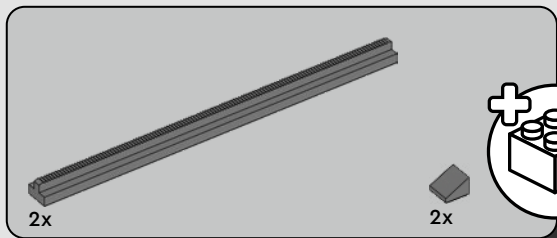

610





8x

611



518



8x

612





8x

613



520

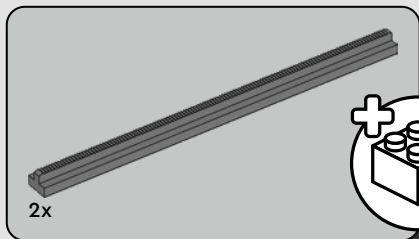

614





8x

615



522



8x

616





8x

617



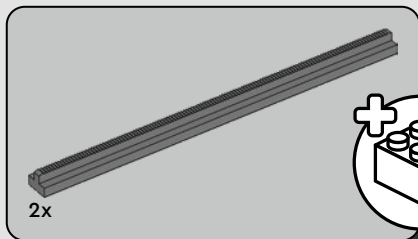

618





8x

619



526



8x

620













1x



2x

625



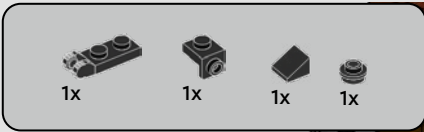

626

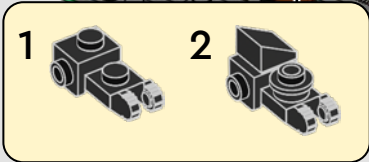
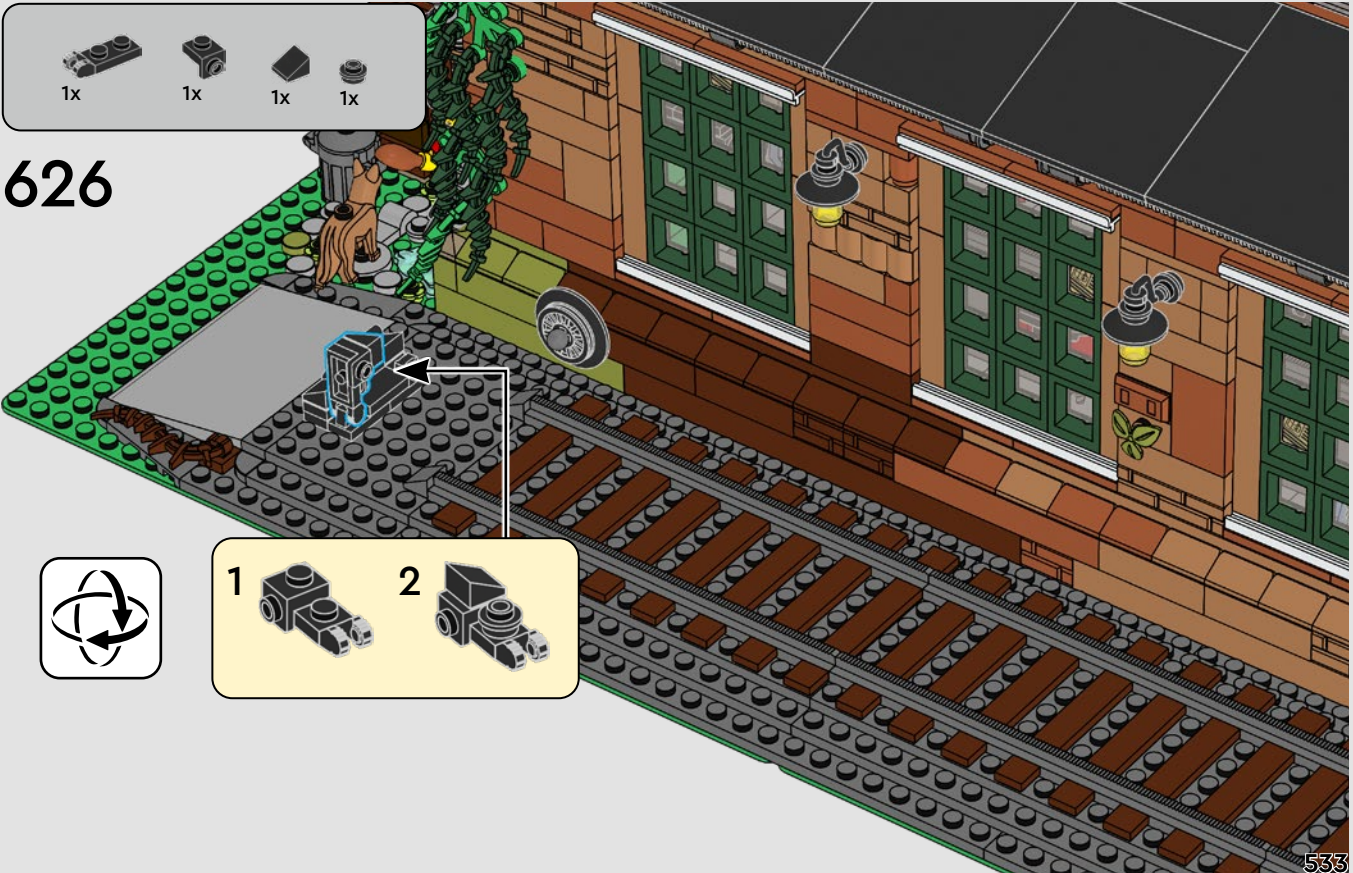

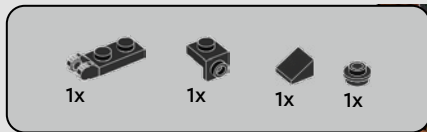

627

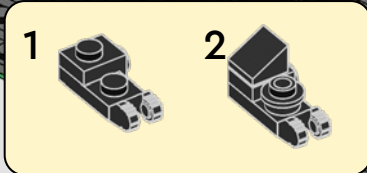
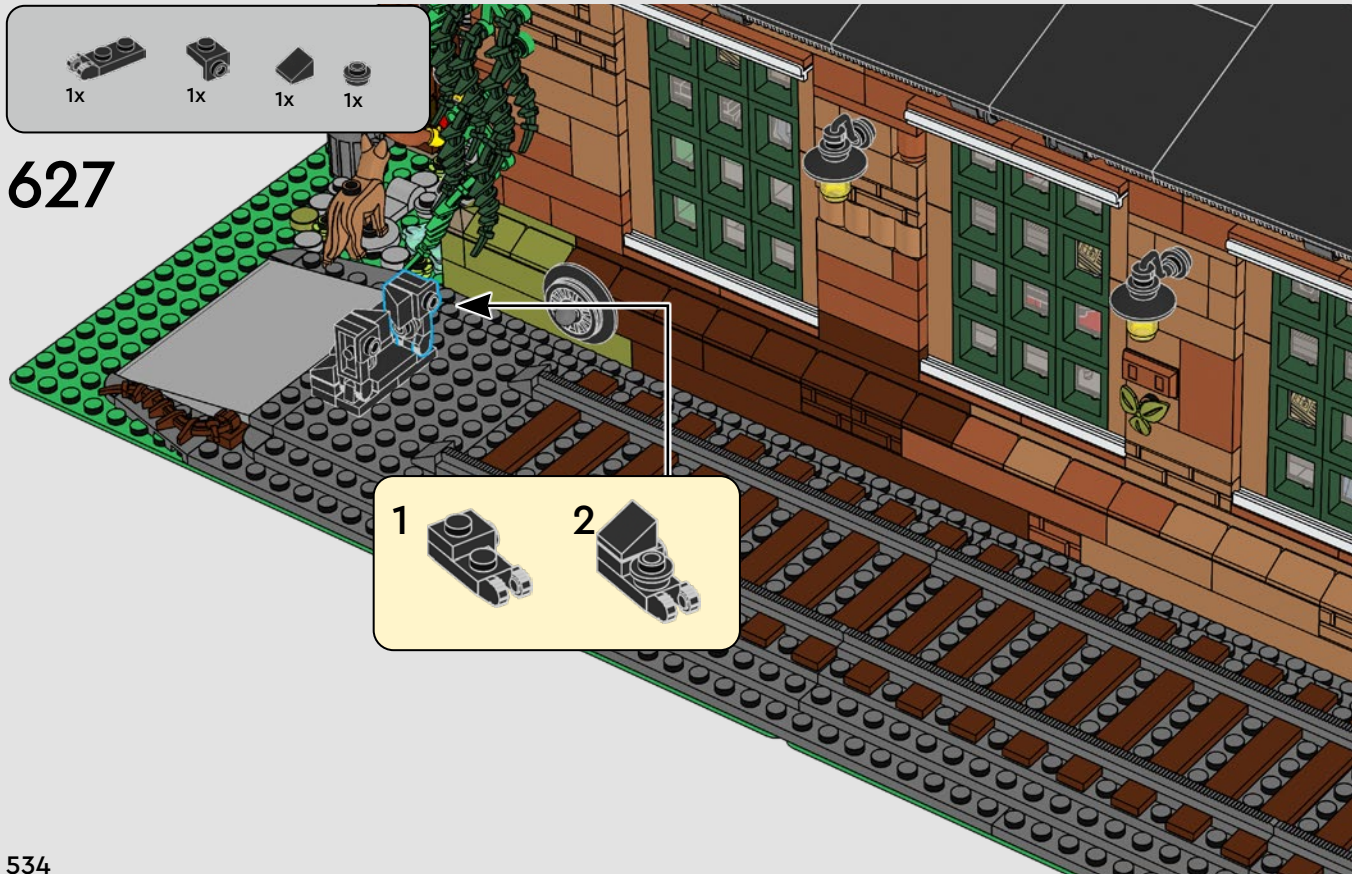

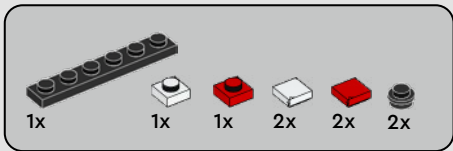
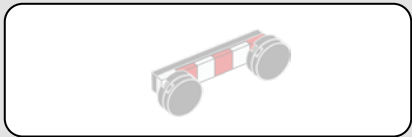

628

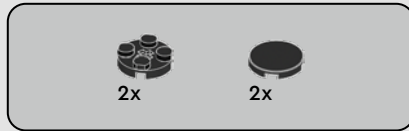
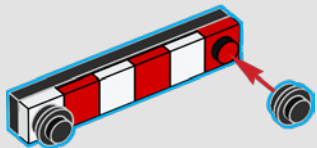

629

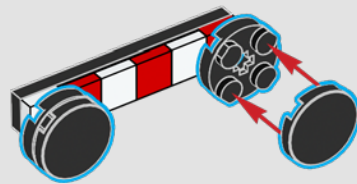

630



536

631

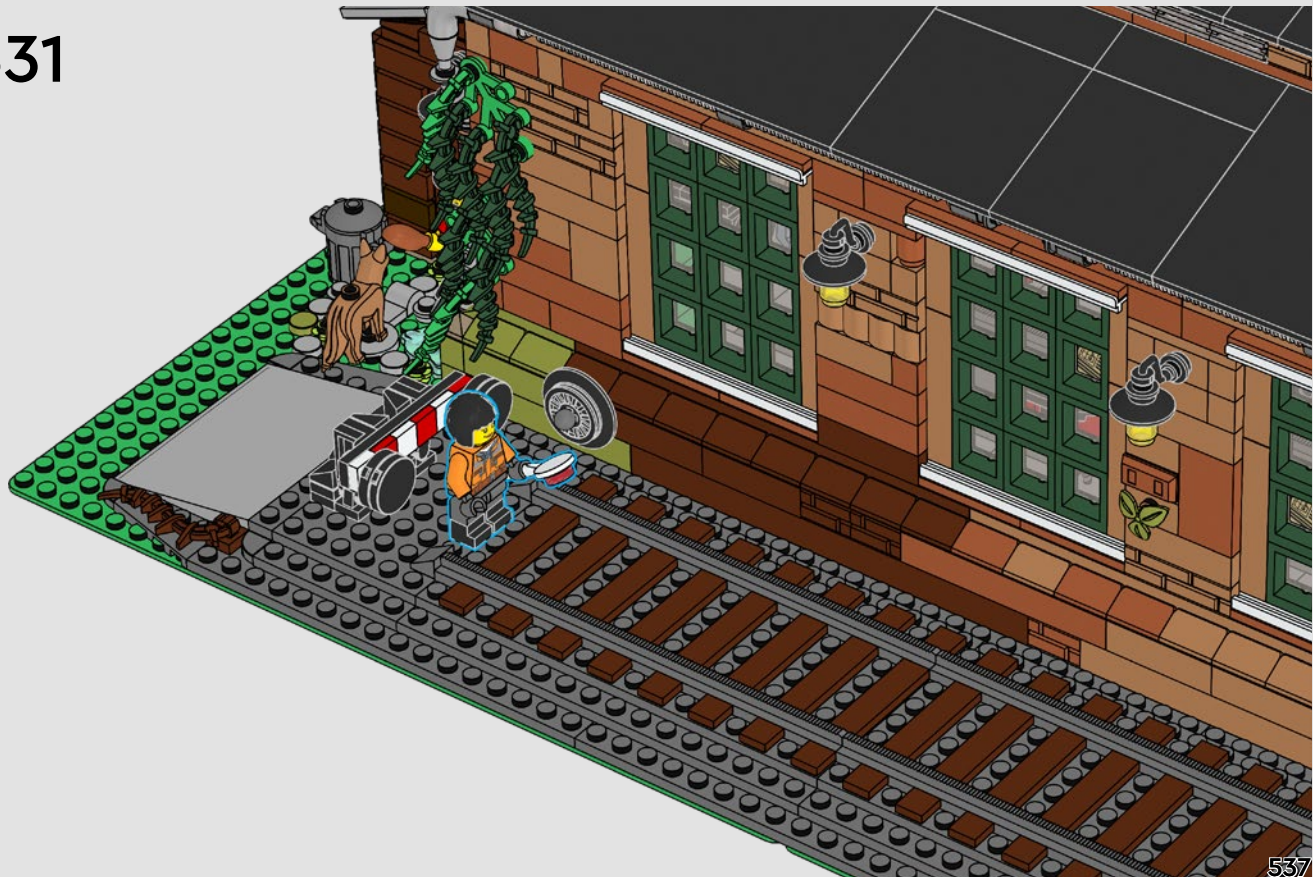



1x

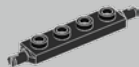

2x

632

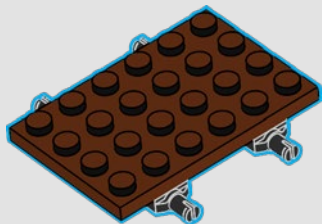

3x

633

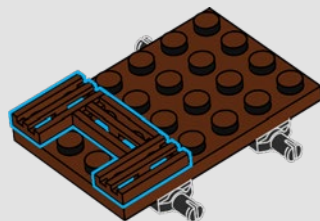

1x



4x



1x



1x

634

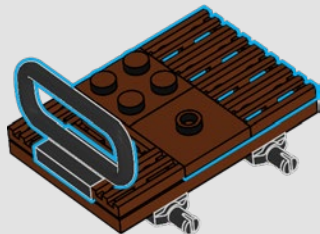

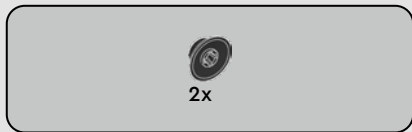

635

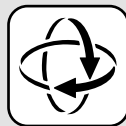
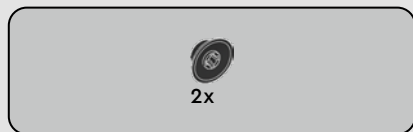
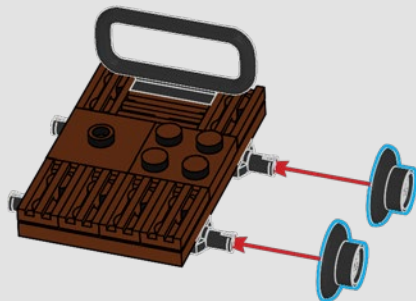

636

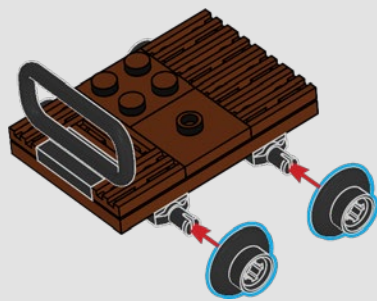



637

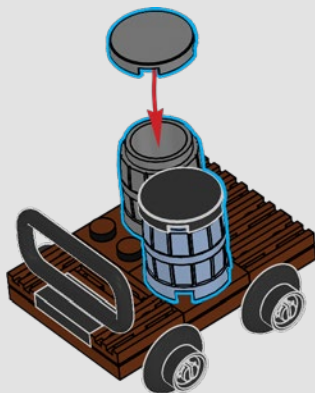

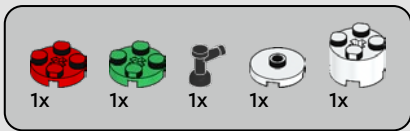

638

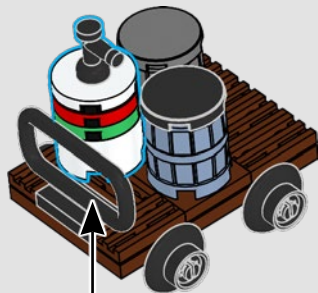
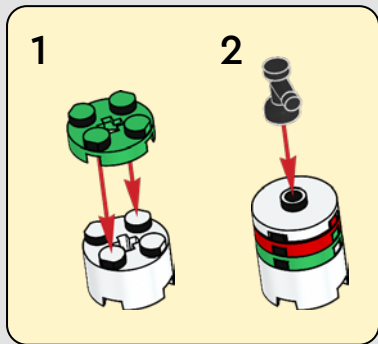

639



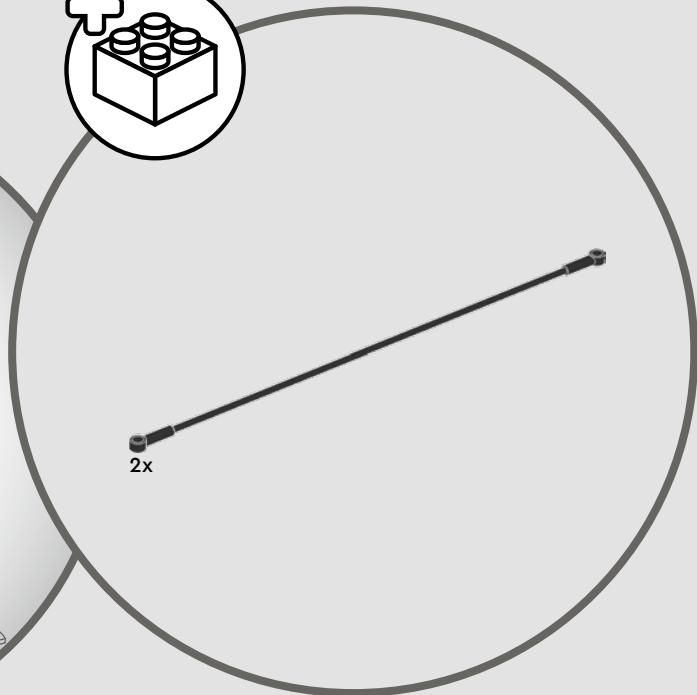
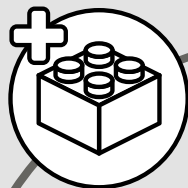



2x



2x

640



2x



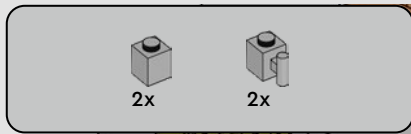

641







2x



2x

643





1x

644



1x



1x

648

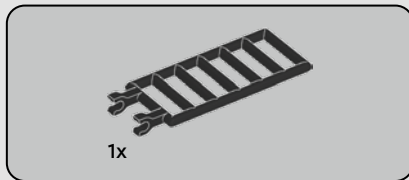
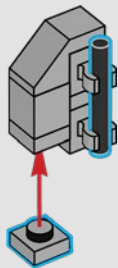

1x

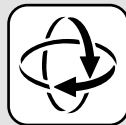

649

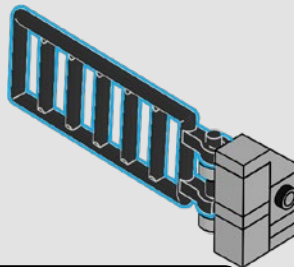

1x



1x

650

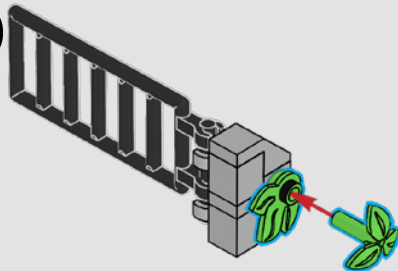

651



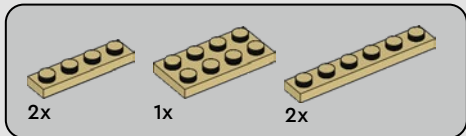
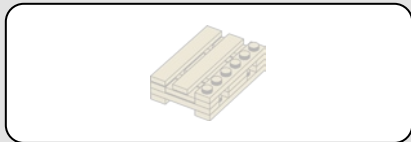

652

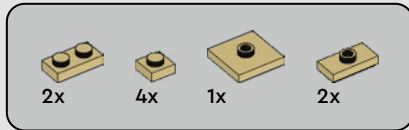
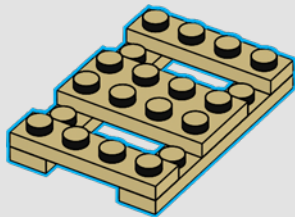

653

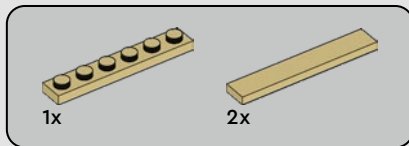
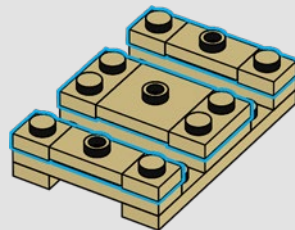

654

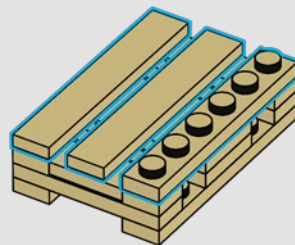

655

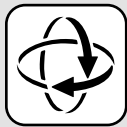

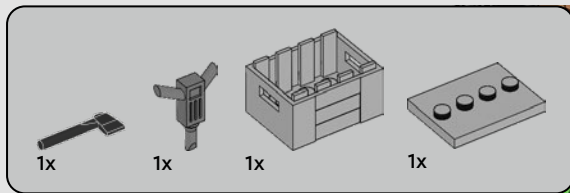

656

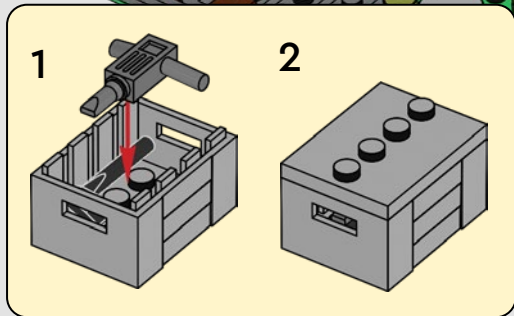
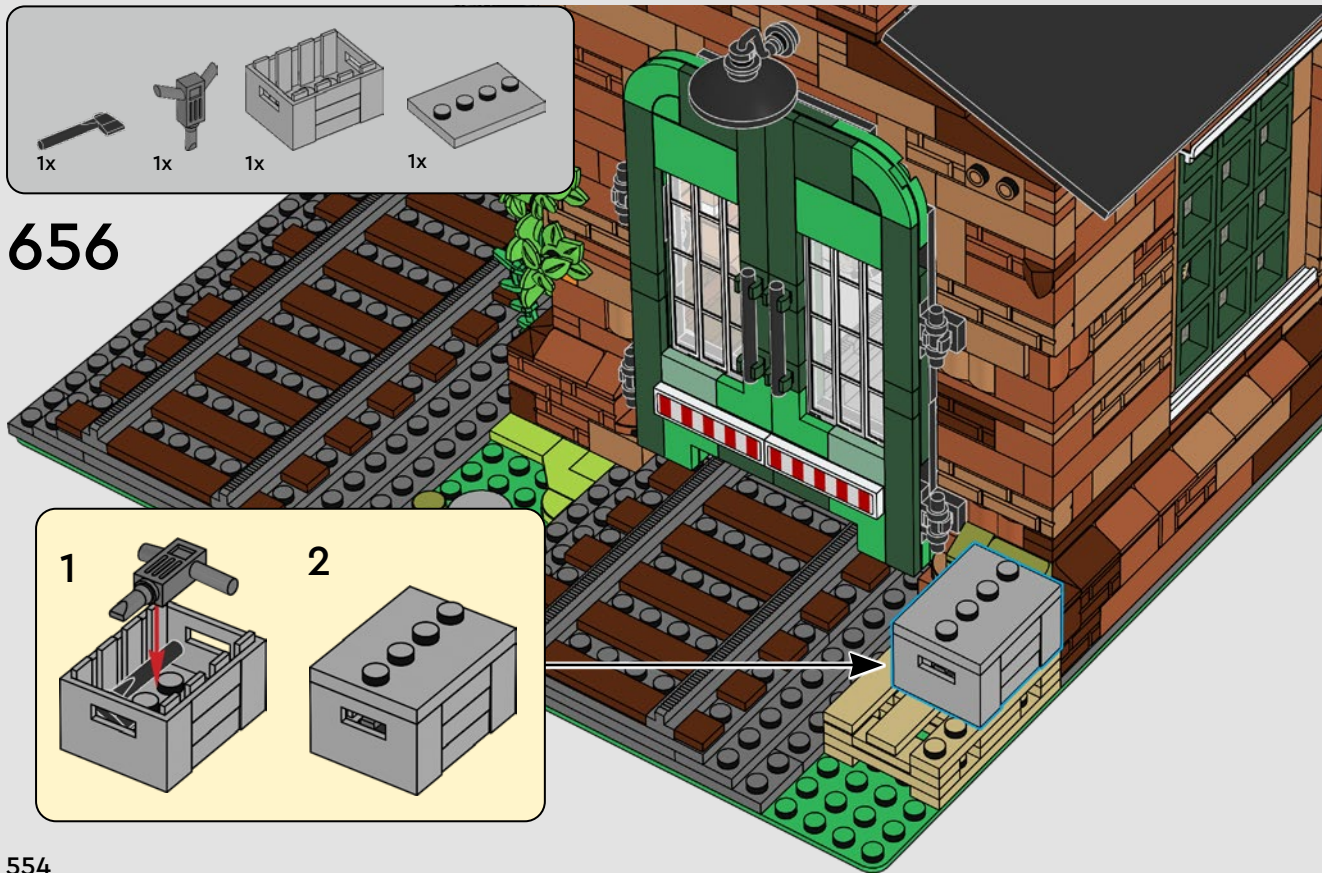

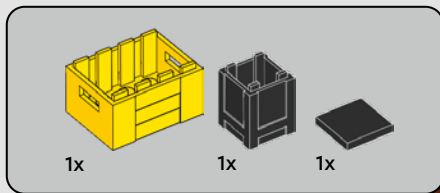

657

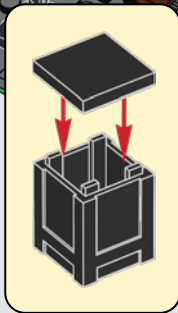

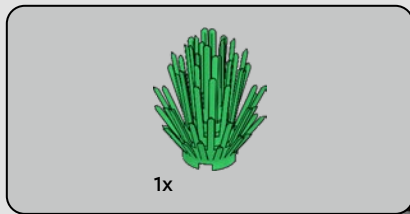

758



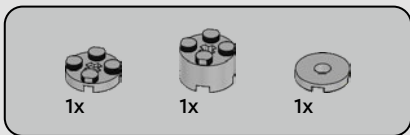
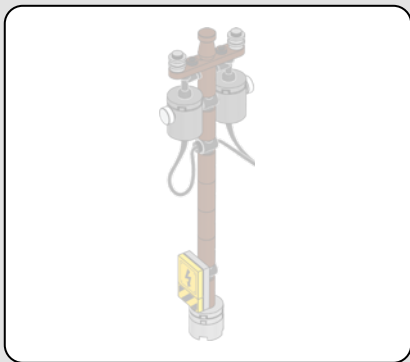

659

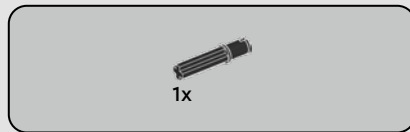
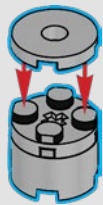

660

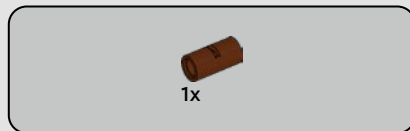

661



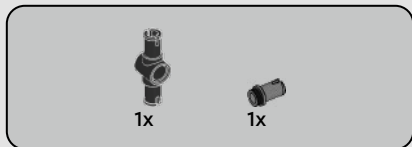

662

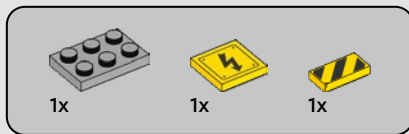
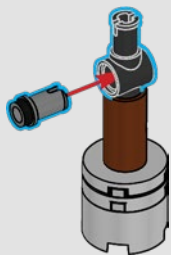

663

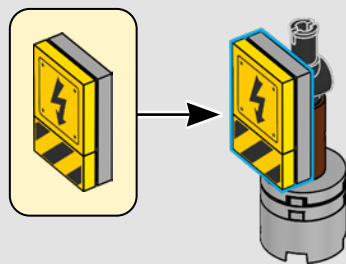



664

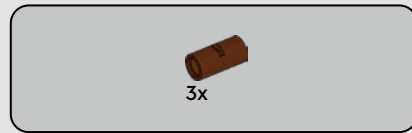
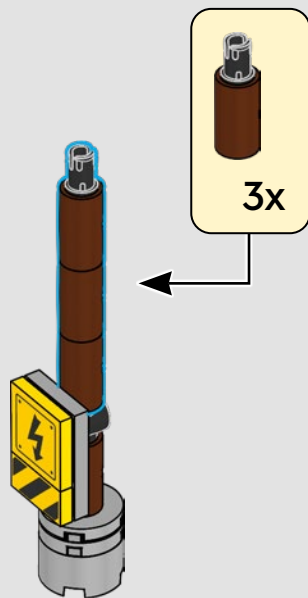

665

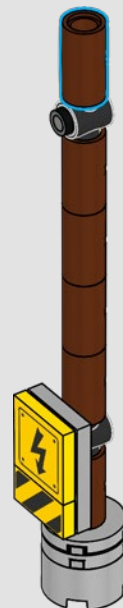

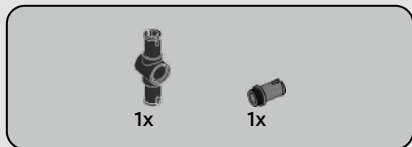

666

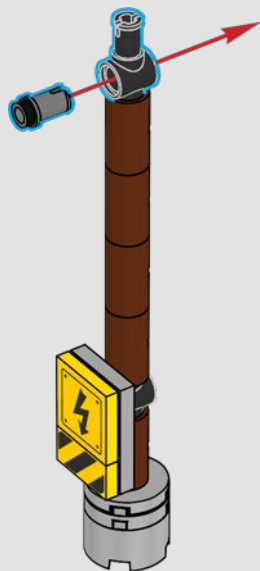

560

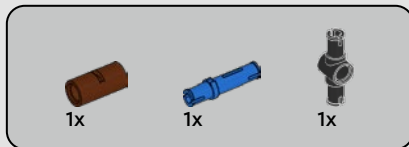

667

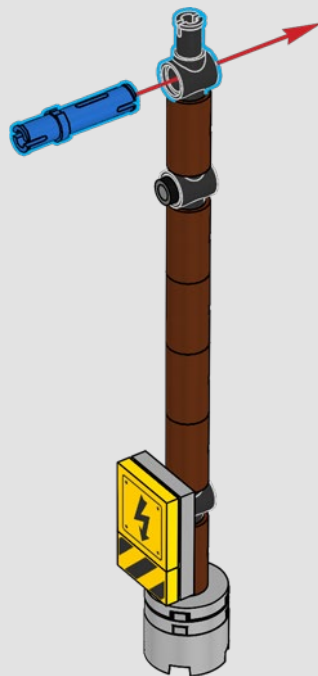



2x



1x



1x



1x

669

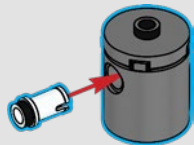

1x



1x

670



562



1x

671



2x

672



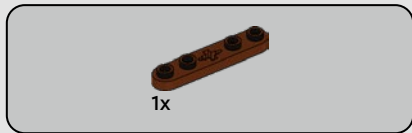

673



674

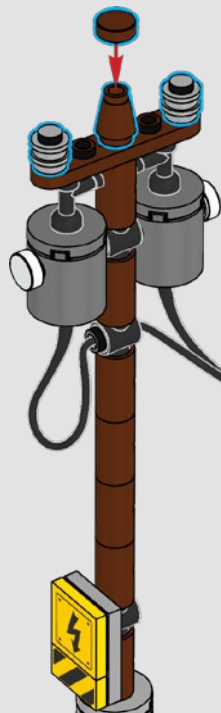

675



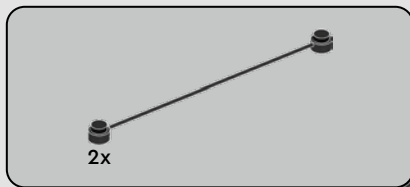

676





1x



1x



1x

677



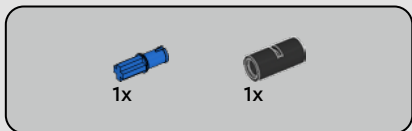

678

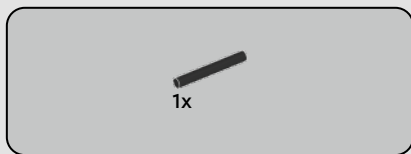

679

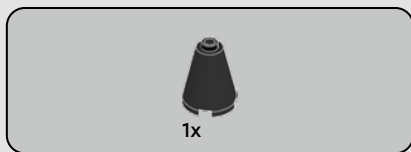

680



681



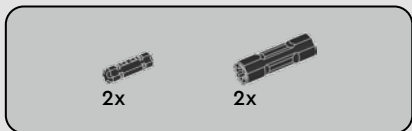

682

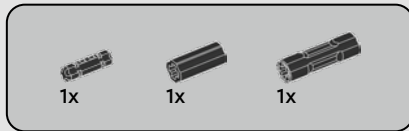

683



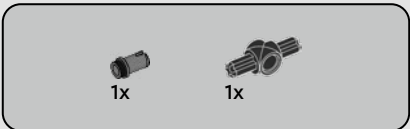
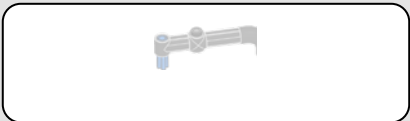

684

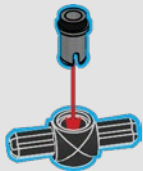

685

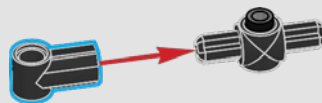



1x



1x



1x

686

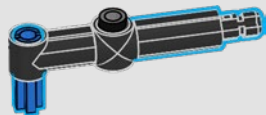

1x

687



688

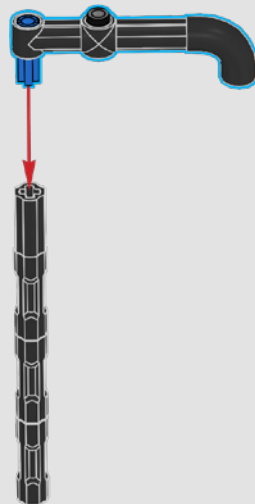



1x

689

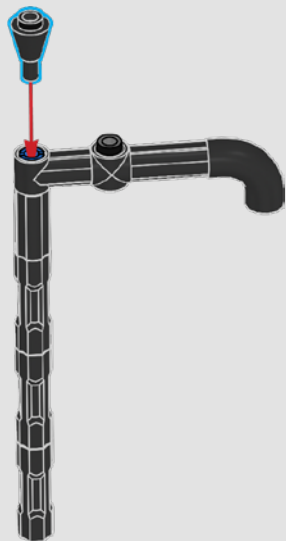

1x



1x



1x

690

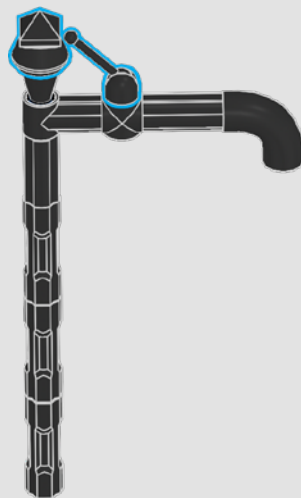

691

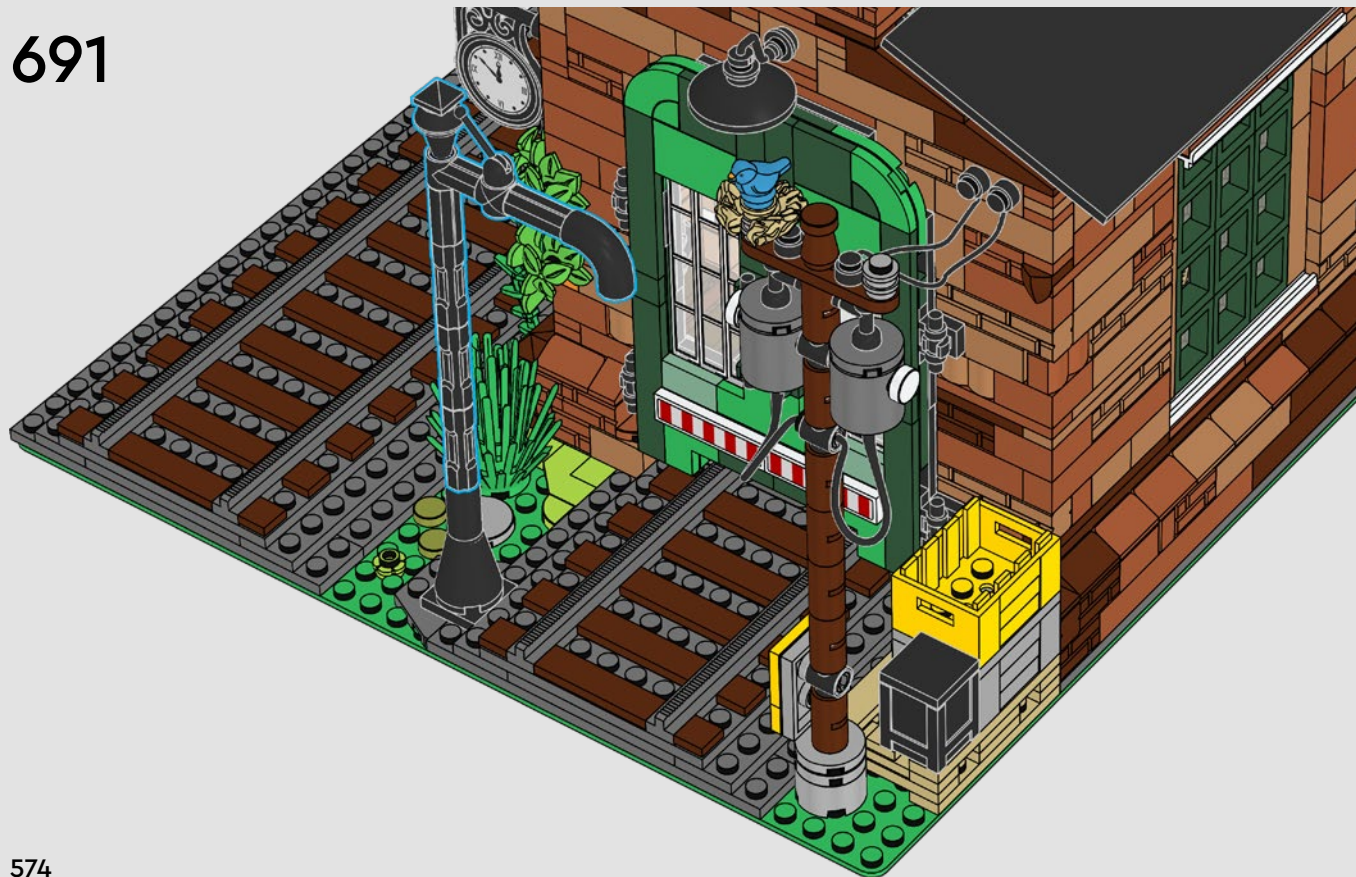

574

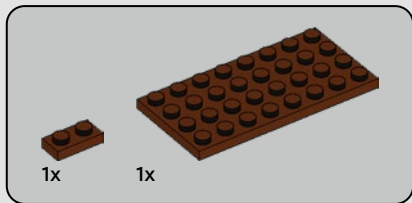
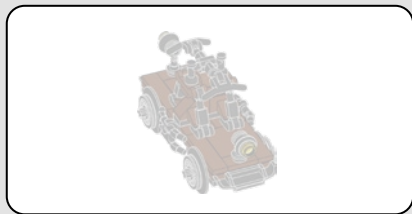

692

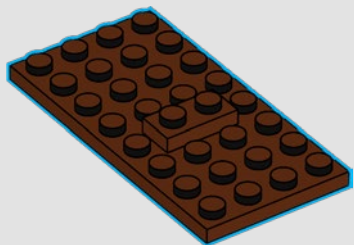

693

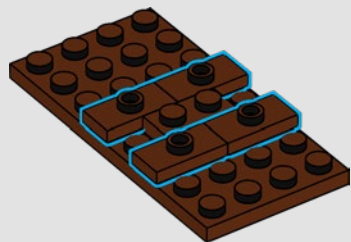

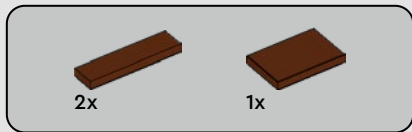

694

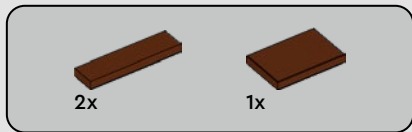
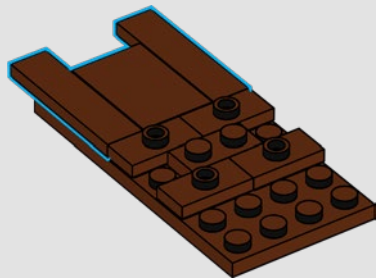

695

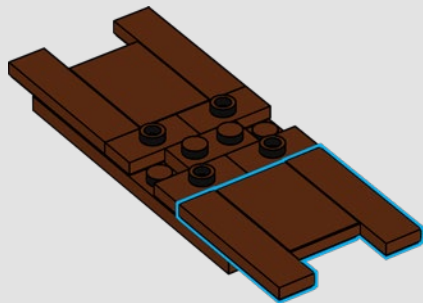



696

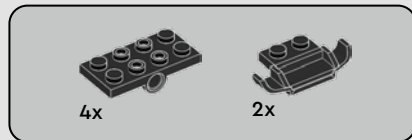
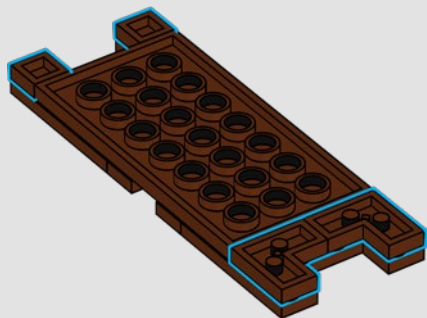

697

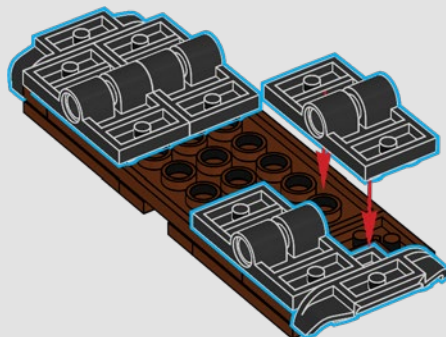

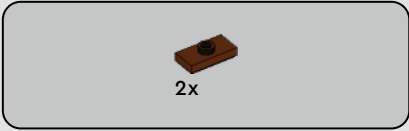

698

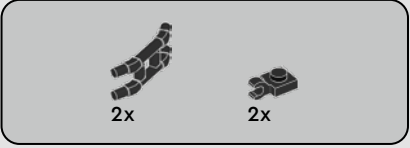
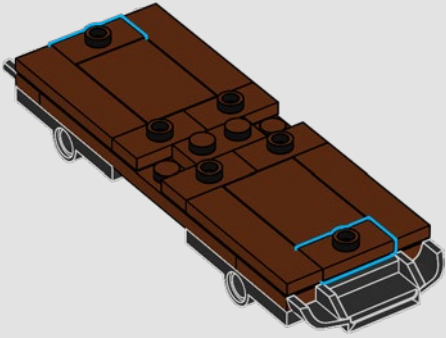

699

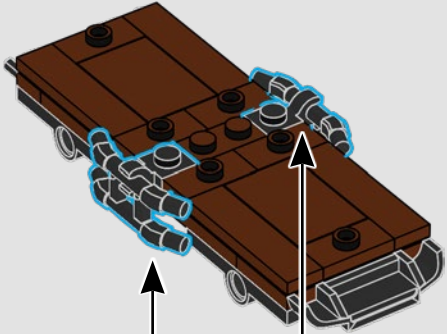
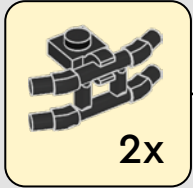

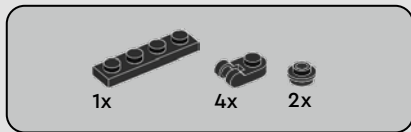

700

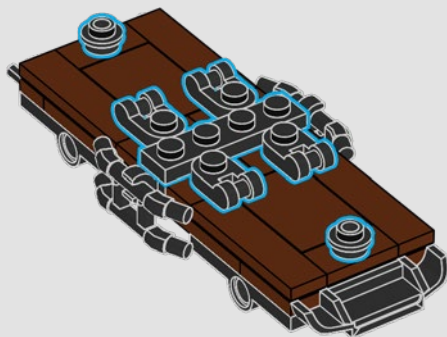

701

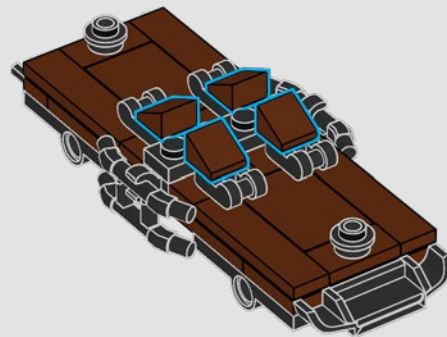

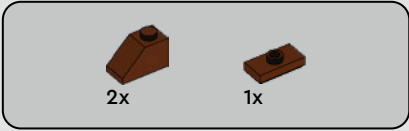

702

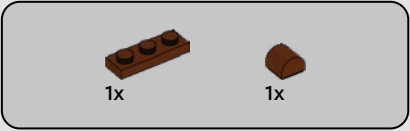
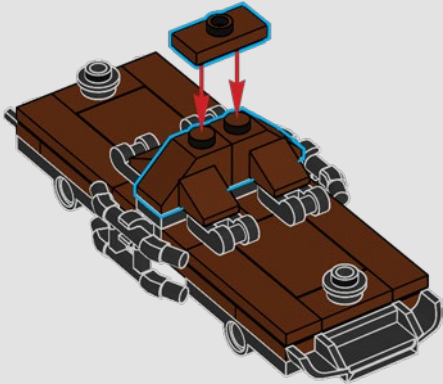

703

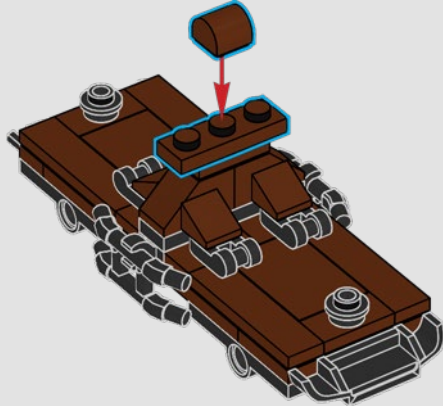



4x



4x

704

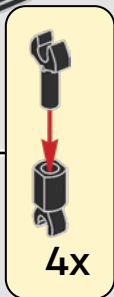
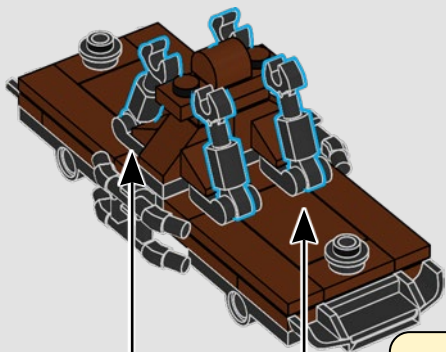

2x

705

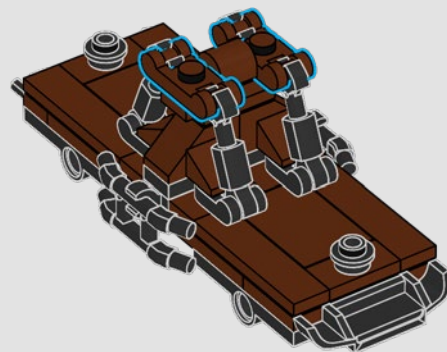



1x



2x

706



2x

707

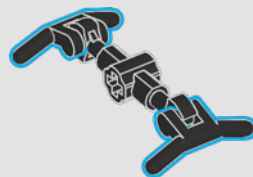

2x

708

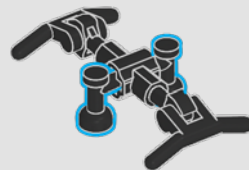

709

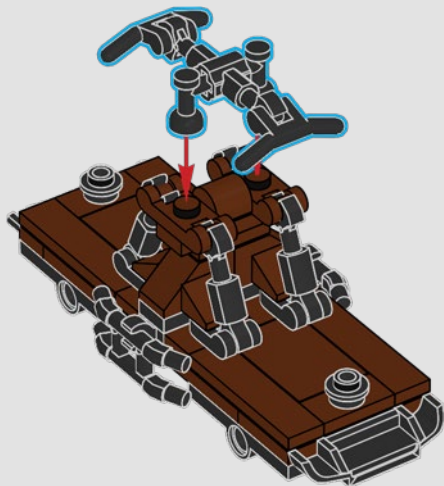

710

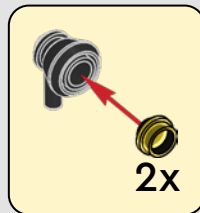
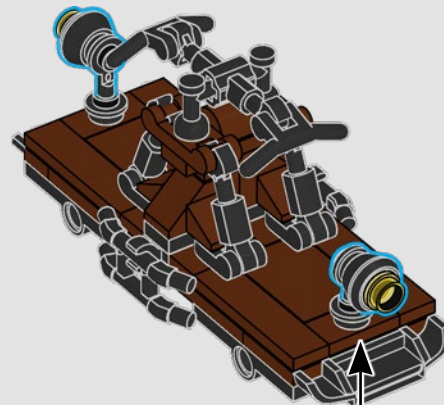

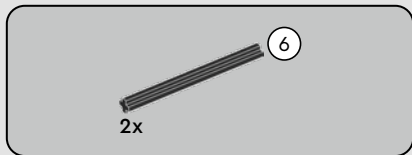

711

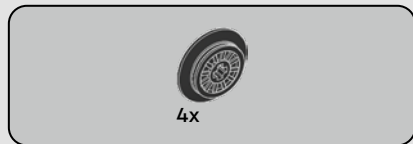
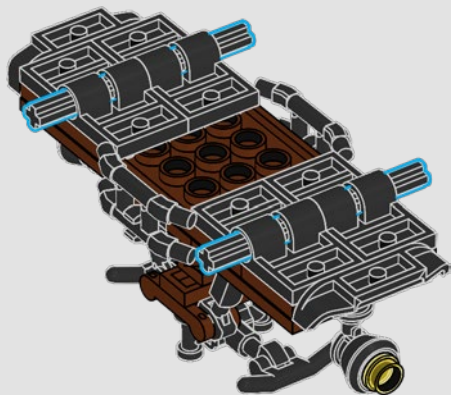



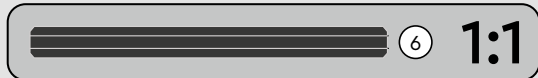
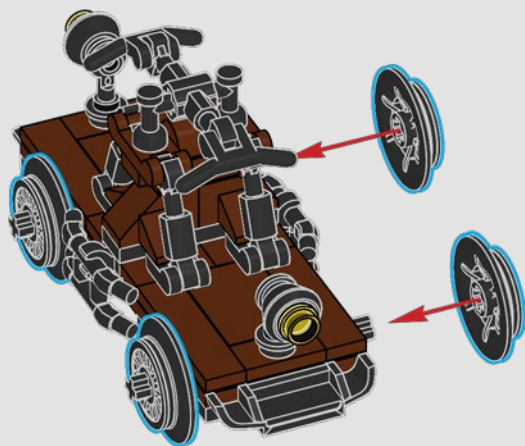









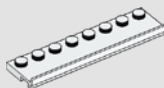







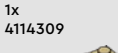













































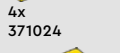

712



713





 2x 6284572	 2x 614301	 6x 4500878	 1x 4114309	 3x 6278441	 2x 306921	 1x 6299413	 4x 302324
 1x 390001	 1x 6093053	 1x 4161734	 3x 4124067	 1x 6224467	 4x 4612575	 1x 6288000	 1x 6329649
 2x 6388018	 1x 6329597	 1x 6400380	 2x 4157277	 1x 389921	 1x 6152679	 1x 6338854	 2x 306924
 1x 6221783	 1x 6329599	 4x 4159553	 2x 74335	 1x 6345637	 2x 4188189	 1x 6224063	 1x 6223076
 2x 307001	 1x 4261470	 2x 4113917	 1x 6223427	 4x 6249907	 2x 4619543	 1x 6174813	 4x 371024
 1x 302401	 1x 6323424	 2x 6092587	 1x 4599453	 2x 383321	 2x 6046379	 1x 6329640	 2x 4560181
 1x 6315564	 1x 6219621	 1x 6360029	 1x 6003001	 2x 403221	 2x 371021	 1x 6271746	 1x 4599378
 1x 6252744	 2x 243101	 1x 4565387	 2x 307021	 1x 4216657	 2x 371021	 2x 6173122	 6x 663624
 1x 6360202	 6x 4501853	 2x 4113233	 2x 302421	 3x 302321	 5x 4206482	 4x 300424	 8x 4189400
 1x 6334236							
 1x 6329606							

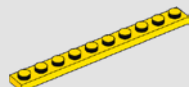

2x
6079138

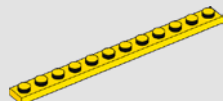

4x
4514844



1x
6088550



1x
73587



4x
6315887



1x
6321194



1x
6056234



20x
6168646



3x
614126



1x
4529236



1x
6356406



6x
6439039



1x
6170545



3x
6366229



1x
6284699



6x
459926



4x
4504382



2x
302426



17x
6335388



68x
407026



4x
6199468



1x
6312449



1x
6477141



1x
307026



1x
6187572



4x
6171060



3x
6299338



4x
4295370



2x
6245281



1x
473326



1x
6269933



1x
6155002



1x
6277468



2x
6359865



7x
6192778



4x
4516843



1x
4177431



2x
6308000



1x
6365482



2x
6196548



4x
6157554



1x
4537551



1x
6323420



5x
6279875



1x
6092664



4x
4109810



4x
4278359



3x
6070695



2x
403226



1x
4653822



5x
6195325



4x
474026



3x
6057397



3x
6179182



1x
6280097



2x
6253260



2x
249626



1x
9339



2x
4512363



2x
6226706



2x
6173119



3x
306926



16x
6266207



2x
4144023



3x
302326



3x
6092585



1x
4144024



3x
300426



1x
6398861



2x
6338799



1x
243226



1x
6146220



2x
3003126



5x
6284110



4x
4140588



1x
6151289



4x
6093525



1x
6396457



4x
300326



1x
6313191



1x
6192346



3x
302226



4x
6482959



2x
306826



1x
4565323



2x
6133722



1x
6166859



16x
6211476



1x
6346247



2x
6089119



1x
6371743



2x
6267045



1x
452226



5x
4180087



4x
6286381



6x
6272184



5x
362326



2x
362226



1x
4558170



1x
383526



1x
4141349



2x
6116604



4x
302126



2x
4504187



1x
6331483



4x
6058966



1x
6043130



5x
6254045



6x
265326



3x
301026



2x
371026



2x
6360129



1x
6314886



1x
6174917



2x
300126



10x
4529155



4x
6194233



44x
4185583



1x
6231575



2x
6338416

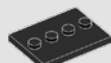

5x
6076678

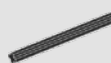

2x
370626



7x
366626



4x
6318582



11x
379526



5x
346026



6x
303226

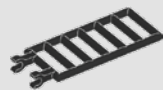

1x
602026



8x
303426

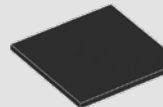

4x
6155125



6x
447726

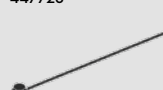

2x
6096955



2x
383226

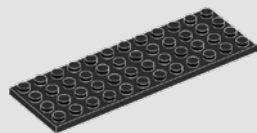

4x
302926

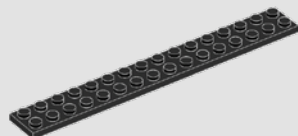

4x
428226



2x
6381295

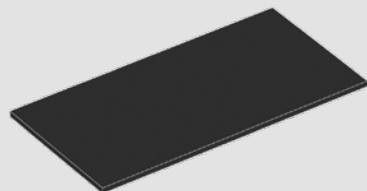

4x
4603646



2x
6338221

590



4x
4522678



1x
300528



1x
302428



1x
6150607



1x
6385644



4x
6270055



2x
6000071



1x
403228



4x
302328



4x
6374489



3x
306928



2x
4107736



1x
6270719



2x
4272665



4x
6374049



4x
4157120



2x
300328



1x
302228



4x
4142717



2x
6365611



2x
6023083



2x
6268814



2x
6062166



2x
6288100



1x
6269009









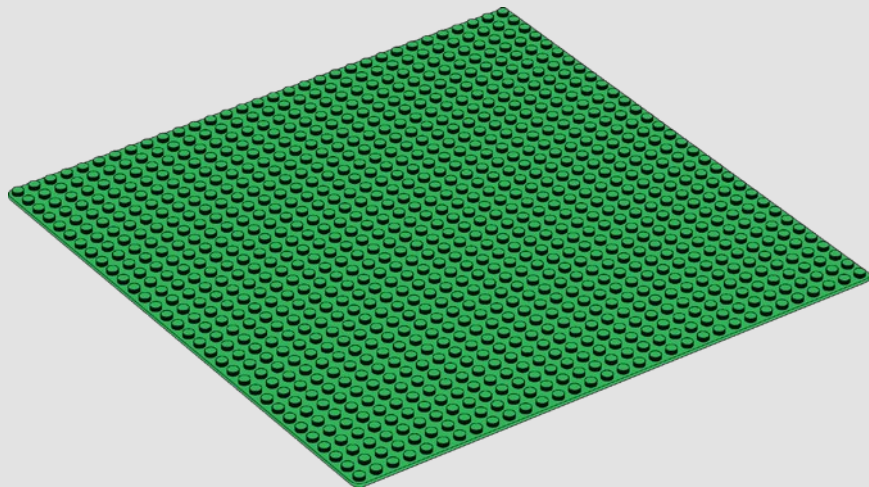













3x
4106356





2x
366628



- 2x
4219692
-  2x
6301284
-  5x
6235080
-  8x
6182261
-  5x
6074890

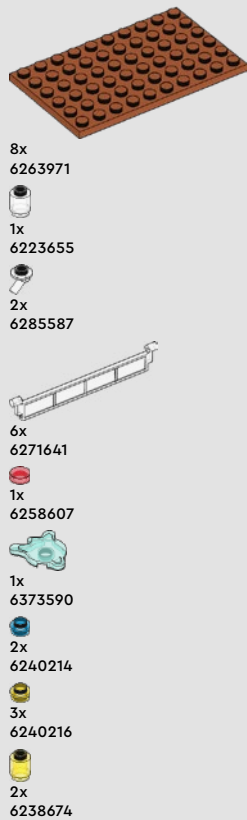









-  10x
6254484
-  8x
4666322
-  7x
6186012
-  1x
6228968
-  1x
6104342
-  1x
6360331
-  26x
6188477
-  3x
4666352
-  22x
6314383
-  3x
6315191
-  4x
6396922
-  4x
4579659
-  6x
4570877
-  1x
4614158
-  1x
6212081
-  16x
6187575
-  8x
6253417
-  4x
6341393
-  15x
6263221



 2x
4216581
 3x
6256734
 6x
4504376
 60x
4211288
 4x
6201911
 3x
6348057
 12x
6062574
 2x
6149677
 4x
4221744
 1x
6371437
 2x
6329114

 1x
6341553
 1x
6167879
 1x
6174229
 2x
6306775
 1x
6248944
 1x
4211157
 1x
6270052
 15x
6035291

 1x
6036503
 1x
6182435
 1x
6223599
 1x
6120224
 7x
6173132
 10x
6361793
 25x
6397820
 9x
4211150
 8x
6214443
 18x
4211151

 12x
6092590
 7x
4224243
 2x
4211199
 2x
6310449
 1x
6270078
 1x
6428805
 2x
6383143
 2x
4211257
 2x
4565394
 1x
4271949

 1x
4216695
 1x
6122977
 2x
4211152
 1x
6100769
 1x
6116613
 2x
6311441
 1x
6132732
 36x
4211194
 1x
4211225

 2x
4595889
 21x
6153594
 8x
6310852
 2x
6262952
 1x
6280388
 6x
4211201
 1x
4211186

 1x
6307618
 1x
6159763
 10x
4211204
 1x
4221590
 5x
4585337
 1x
4271874
 10x
6096701



1x
4223683



1x
4211207



4x
4222627

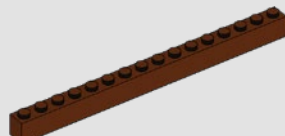

7x
6258989

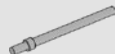

1x
6170418



1x
4539481

594



1x
6199163



1x
6343976



1x
6271165



1x
6167667



4x
6284071



6x
4211525



4x
6168647



2x
6329581



1x
6258831



4x
6326748



4x
6194808



1x
6275844



1x
6057487



2x
4211483



1x
6262085



4x
4211415



5x
4211399



1x
4558953



2x
4211389



4x
6170569



2x
6345426



1x
6004729



1x
4514195



1x
6052200



1x
4211475



2x
6152344



3x
4211807



1x
6179186



1x
4211526



2x
6183782



1x
6151349



1x
6280396



10x
4211414



3x
6066097



3x
6213378



2x
4211398



1x
6044729



4x
6126082



8x
4211413



1x
6177078



1x
4211397



1x
4211815



1x
6211969



1x
6116608



1x
4211396



1x
6171894



8x
4211356



8x
6276045



2x
6257593



2x
4211445



4x
4560183



1x
6372029



1x
6079461



1x
6108560



1x
4211438



1x
4211549



24x
6402193



1x
4211837

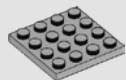

1x
4243797

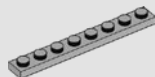

4x
4211425

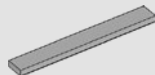

1x
4211481



2x
4251149

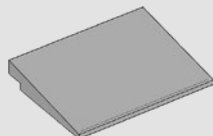

1x
6440325



1x
6292172



3x
6231765



4x
4210633



6x
6362252



11x
6395635



4x
4210719



1x
4211098



4x
6199549



2x
4504378



1x
4210848



8x
6332045



2x
6428819



1x
6364352



2x
6221607



1x
6296892



1x
4210782



1x
4210788



4x
4567887



1x
6278986



2x
4161673



1x
6056296



1x
6170695



3x
6115080



1x
4211010



3x
4211088



8x
4211052



6x
6396058



2x
4210811



1x
4261117



1x
4211007



1x
6347464



1x
6310596



1x
4210635



4x
6236949



1x
6247784



2x
6309059



1x
4211055



2x
4211094



3x
4211104



1x
4239891



1x
6171068



1x
6501152



1x
4527082



1x
4211043



2x
4211001



4x
4211085



2x
4560184



6x
4210875



6x
4211002

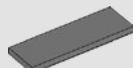

10x
6321746



1x
4210998



6x
6187438



2x
4210997



1x
4211061



2x
4210678



2x
4210794



1x
6133611



3x
4211067



1x
4211114



1x
6000970

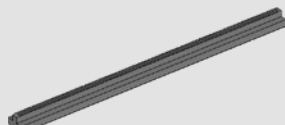

12x
6313875

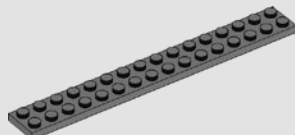

16x
4210796

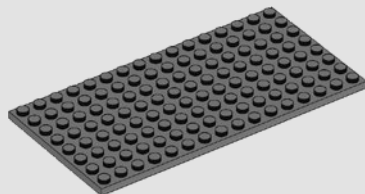

3x
4654613

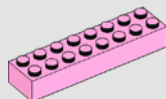

2x
6338201



1x
6186672



1x
6283475



1x
6133832



2x
6194729



3x
6272144



5x
4566688



4x
6167928



2x
6310366



2x
6313874



3x
6300103



12x
6378362



20x
6057986



5x
6215606



1x
6248536



12x
6339311



1x
6324205



1x
6380634



5x
6360035



43x
6218358



4x
4651231



10x
4569382



10x
4656783



8x
6411587



11x
6401015



1x
6401021



1x
6021997



1x
6218360



2x
6177535



8x
6192922



2x
6189103



1x
4614195



1x
4651232



21x
6055309



17x
6223183



3x
6167700



7x
6135191



4x
6343854



2x
6344931



4x
6295464



10x
6099341



1x
6106193



11x
6396749



8x
6347603

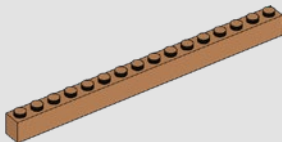

12x
6411590



1x
6214214



1x
4633691



1x
6096993



2x
6161155



1x
6207840



1x
6363150



2x
6088641



2x
4619636



1x
6167576



1x
6210601

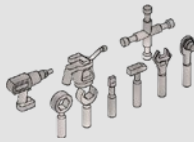

1x
6103444



2x
6044636



1x
6287960



1x
6374213



4x
6284595



1x
6002841



1x
6058245



2x
6285465



4x
6398008



4x
6016468



4x
6024722



1x
6278087



1x
6268815



2x
6062697

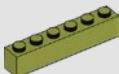

1x
6020143

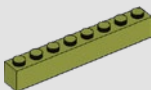

1x
6058219



40x
6051422